

# **Korenix 5010G / 4510 Series Industrial Managed Ethernet Switch**

---

## **User Manual**

Ver. 2.13, NOV-2014

**Firmware v2.8a**

**Hardware v2.3**

The logo for Korenix, featuring the word "korenix" in a bold, blue, lowercase sans-serif font. A small orange circle is positioned above the letter 'i'.

**[www.korenix.com](http://www.korenix.com)**

# **Korenix JetNet 5010G/ 4510 Series Industrial Managed Ethernet Switch User's Manual**

## **Copyright Notice**

Copyright © 2007-2013 Korenix Technology Co., Ltd.

All rights reserved.

Reproduction in any form or by any means without permission is prohibited.

## **Federal Communications Commission (FCC) Statement**

This equipment has been tested and found to comply with the limits for a Class A digital device, pursuant to Part 15 of the FCC Rules. These limits are designed to provide reasonable protection against harmful interference when the equipment is operated in a commercial environment. This equipment generates, uses, and can radiate radio frequency energy and, if not installed and used in accordance with the instruction manual, may cause harmful interference to radio communications. Operation of this equipment in a residential area is likely to cause harmful interference in which case the user will be required to correct the interference at his expense.

The user is cautioned that changes and modifications made to the equipment without approval of the manufacturer could void the user's authority to operate this equipment.

# Index

<b>1</b>	<b>Introduction</b>	<b>1</b>
1.1	Overview	1
1.2	Major Features	1
1.3	Package List	2
<b>2</b>	<b>Hardware Installation</b>	<b>4</b>
2.1	Hardware Introduction	5
2.2	Wiring Power Inputs	7
2.3	Wiring Digital Input	8
2.4	Wiring Digital Output	8
2.5	Wiring Earth Ground	8
2.6	Wiring Fast Ethernet Ports	9
2.7	Wiring Combo Ports	10
2.8	Wiring RS-232 Console Cable	10
2.9	DIN-Rail Mounting Installation	11
2.10	Wall-Mounting Installation	13
<b>3</b>	<b>Preparation for Management</b>	<b>14</b>
3.1	Preparation for Serial Console	14
3.2	Preparation for Web Interface	15
3.3	Preparation for Telnet Console	17
<b>4</b>	<b>Feature Configuration</b>	<b>20</b>
4.1	Command Line Interface Introduction	21
4.2	Basic Setting	27
4.3	Port Configuration	43
4.4	Network Redundancy	51
4.5	VLAN	71
4.6	Private VLAN	81
4.7	Traffic Prioritization	87
4.8	Multicast Filtering	92
4.9	SNMP	96
4.10	Security	99
4.11	Warning	105
4.12	Monitor and Diag	112
4.12	Device Front Panel	118
4.13	Save to Flash	119
4.14	Logout	120
<b>5</b>	<b>Appendix</b>	<b>121</b>
5.1	Pin Assignment of the RS-232 Console Cable	121
5.2	Korenix SFP family	122
5.3	Korenix Private MIB	125
5.4	ModBus TCP /IP	126
5.5	Revision History	137
5.6	About Korenix	140

# **1 Introduction**

Welcome to Korenix 7 10/100TX plus 3 10/100/1000TX/100FX/1000FX Industrial Managed Ethernet Switch User Manual. This manual covers several Managed Ethernet Switch models for different Ethernet port combination. The following topics are covered in this chapter

## **1.1 Overview**

### **1.2 Major Features**

### **1.3 Package Checklist**

## **1.1 Overview**

Industrial 10-port Managed Ethernet Switches, have 7 10/100Base-TX ports and 3 combo ports, respectively 10/100/1000 RJ-45 / 100FX / Gigabit SX/LX, or 10/100 RJ-45 /100FX for diferent modesl. Those Switches is especially designed to operate under harsh environmental conditions. The switches provide solid foundation for a highly fault-tolerant and easily-managed network. The Managed 10-port Switch can be remotely configured by Telnet, Web browser, JetView and managed by Simple Network Management Protocol (SNMP) and Remote Monitoring (RMON). You can also connect the attached RS232 console cable to manage the switch by Command Line Interface (CLI). CLI commands are Cisco-Like commands, your engineers who are familiar with Cisco products don't need to learn new rules for CLI commands.

Security is enhanced with advanced features such as 802.1Q VLAN and Port/IP security. Performance is optimized by QoS and IGMP Snooping/Query. Korenix 3<sup>nd</sup> generation Ring technology, Multiple Super Ring, enables superb self-healing capability for network failure. The fastest failover time is enhanced from 300ms to 5ms for 10/100TX RJ-45 ports, and 30ms for 100FX and Gigabit Fiber. This is Korenix patented ring technology, which is registered in most countries. For interoperability with your existed network, the 10-port Managed Switch series also come with an advanced redundant network solution, Ring Coupling and Rapid Dual Homing technology. With Ring Coupling and Rapid Dual Homing technology, Ethernet Ring can be extended more easily. No matter with Korenix switch or other managed switches.

The IP31-design aluminum case further strengthens the Switch's withstand ability in harsh industrial environment. The event warning is notified to the network administrator via e-mail, system log, or to field engineers by relay output. The Industrial Managed Ethernet Switch has also passed CE/ FCC/ UL safety certifications to help ensure safe and reliable data transmission for industrial applications. The 10-Port Managed Ethernet Switch Series will be your best option for highly-managed industrial network.

## **1.2 Major Features**

Korenix 10-port Manaed Ethernet Switch Series products have the following features:

- SFP ports support 100/1000 Fiber with Digital Diagnostic Monitoring (DDM) to monitor long distance fiber quality.

- Multiple Super Ring (recovery time <5ms), Rapid Dual Homing, Multiple Ring, and MSTP/RSTP
- VLAN, Private VLAN, QinQ, GVRP, QoS, IGMP Snooping V1/V2/V3, Rate Control, Port Trunking, LACP, Online Multi-Port Mirroring
- 32Gbps Non-Blocking, switch backplane 8K MAC address table
- Supports LLDP and JetViewPro i2NMS software for auto topology visualization and efficient group management
- Supports console CLI , Web, SNMP V1/V2c/V3, RMON, HTTPS, SSH for remote management
- Advanced security feature supports IP Security, Port Security, advanced SSHL/SSL authentication key configuration, Telnet/Http service control
- DHCP Server with advanced function –DHCP option 82 with Relay circuit, DHCP server by port based, IP and MAC Binding, 802.1x network access control.
- Event Notification by E-mail, SNMP trap, Syslog, Digital Input and Relay Output
- Supports Modbus TCP/IP client for Factory Automation
- Supports Multiple Language for Web User Interface
- 10.5~60Vdc (v2.3 Hardware)
- IP31 rugged aluminum case
- Operating temperature -25~70°C for **7+3G/ 7+3 100** Switch, -40~75°C for wide temperature mode **7+3G/ 7+3 100** Switch; For the UL 60950-1, the high temperature only support 60°C for all models

**Note: The detail spec is listed in Appendix 5.1.**

The following table listed the nick name used in this user manual for Korenix model mapping.

Model	Description	Managed/ Temperature
JetNet 5010G	7 10/100TX, plus 3 10/100/1000TX, SFP 100FX/1000X Combo. ( <b>7+3G</b> )	Telnet, SNMP, Http (Web), -25~70°C
JetNet 4510	7 10/100TX, plus 3 10/100TX, SFP 100FX Combo. ( <b>7+3 100</b> )	Telnet, SNMP, Http (Web) , -25~70°C
JetNet 5010G-w	7 10/100TX, plus 3 10/100/1000TX, SFP 100FX/1000X Combo. ( <b>7+3G</b> )	Telnet, SNMP, Http (Web) , -40~75°C
JetNet 4510-w	7 10/100TX, plus 3 10/100TX, SFP 100FX Combo. ( <b>7+3 100</b> )	Telnet, SNMP, Http (Web) , -40~75°C

### 1.3 Package List

The product is shipped with following items:

- One industrial Managed Ethernet switch
- One DIN-Rail clip (attached to the switch)
- One wall mounting plate and 4 screws (M3 in 6 mm length)
- One RS-232 DB-9 to RJ-45 console cable
- Documentation and Software CD

■ Quick Installation Guide

If any of the above items are missing or damaged, please contact your local sales representative.

# **2 Hardware Installation**

This chapter includes hardware introduction, installation and configuration information.

Following topics are covered in this chapter:

## **2.1 Hardware Introduction**

Dimension

Panel Layout

Bottom View

## **2.2 Wiring Power Inputs**

## **2.3 Wiring Digital Input**

## **2.4 Wiring Relay Output**

## **2.5 Wiring Ethernet Ports**

## **2.6 Wiring Combo Ports**

## **2.7 Wiring RS-232 console cable**

## **2.8 DIN-Rail Mounting Installation**

## **2.9 Wall-Mounting Installation**



## 2.1 Hardware Introduction

### Dimension

Industrial 7+3G /7+3 100 Managed Switch witch dimension (W x H x D) is **96mm x 137mm x 119mm**

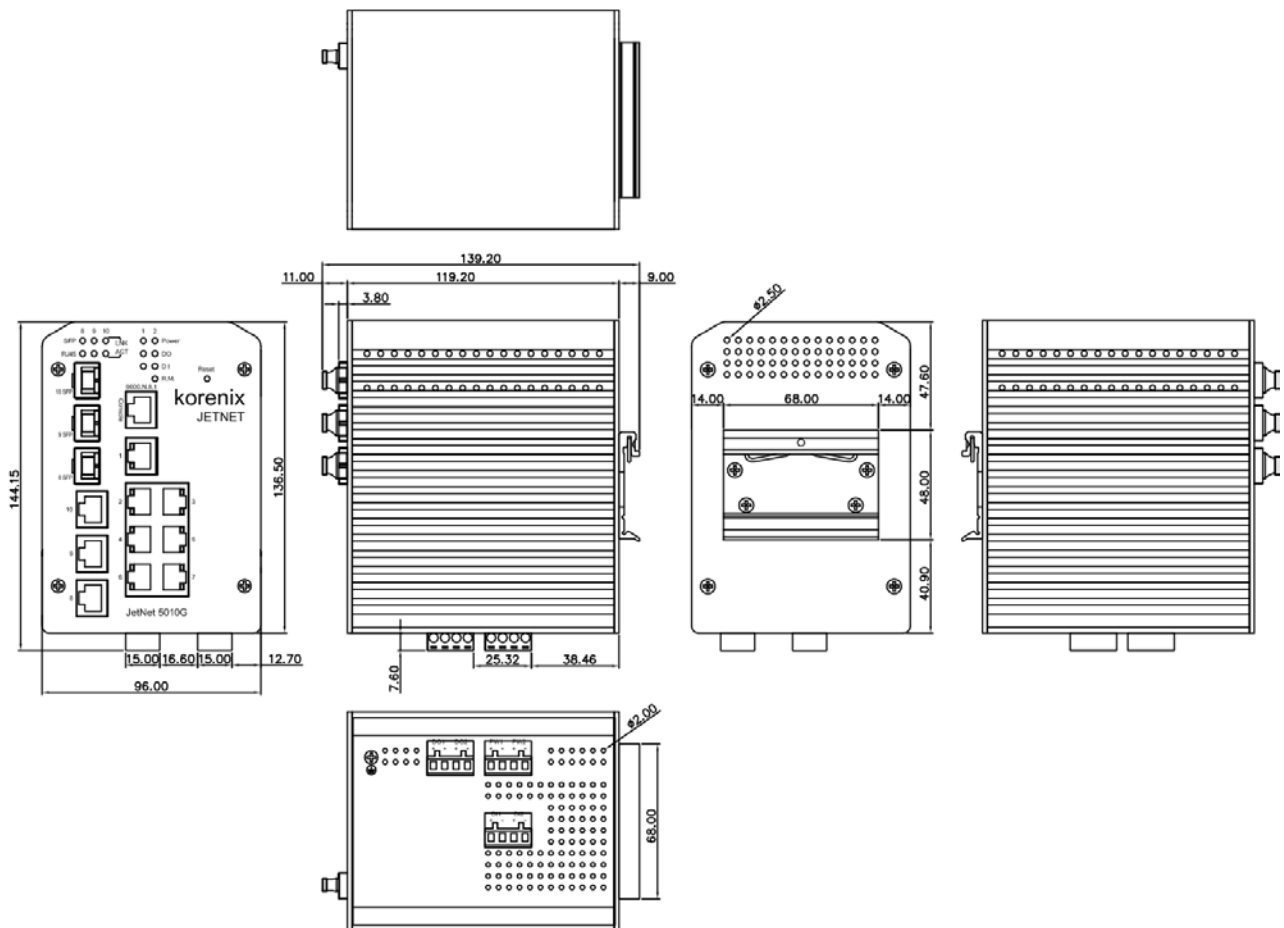

## Panel Layout

The front panel includes 10/100Mbps Fast Ethernet ports, Gigabit Ethernet ports, SFP slot, RS232 console port, System / Combo Port LED and Reset button.

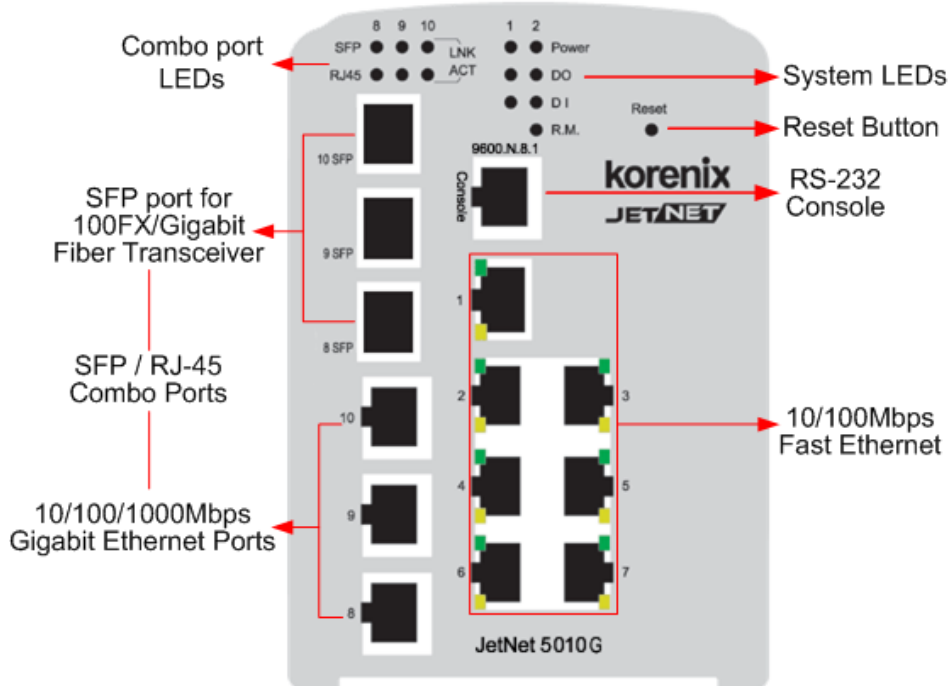

## Bottom View

The bottom view of the Industrial 7+3 Gigabit Managed Switch consists of three terminal block connectors with two DC power inputs, two Digital Inputs, 2 Relay Outputs and 1 Earth Ground.

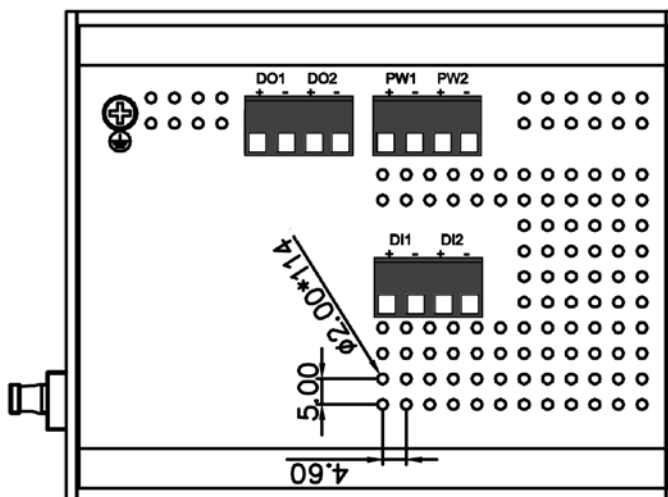

Note: The unit intended to use vertical direction, with DIN-rail or wall-mount only.

## 2.2 Wiring Power Inputs

Follow below steps to wire the Switch's redundant DC power inputs.

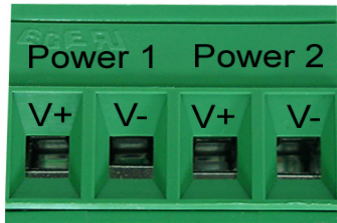

1. Insert positive and negative wires into V+ and V- contacts respectively of the terminal block connector
2. Tighten the wire-clamp screws to prevent DC wires from being loosened.
3. Power 1 and Power 2 support power redundancy and polarity reverse protection functions.
4. Positive and negative power system inputs are both accepted, but Power 1 and Power 2 must apply the same mode.

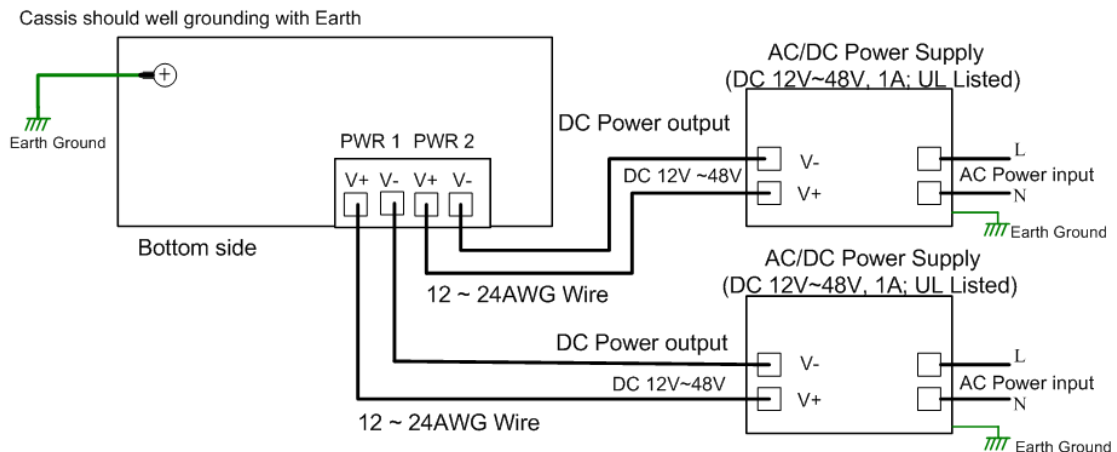

**Note 1:** It is a good practice to turn off input and load power, and to unplug power terminal block before making wire connections. Otherwise, your screwdriver blade can inadvertently short your terminal connections to the grounded enclosure.

**Note 2:** The range of the suitable electric wire is from 12 to 24 AWG.

**Note 3:** If the 2 power inputs are connected, the Switch will be powered from the highest connected voltage. The unit will alarm for loss of power, either PWR1 or PWR2.

**Note 4:** To use the UL Listed **LPS** power supply with output Rating 12-48 Vdc or 10.5~60Vdc for 2.3 hardware version, minimum 1 A.

## 2.3 Wiring Digital Input

The Switch provides 2 digital inputs. It allows users to connect the termination units' digital output and manage/monitor the status of the connected unit. The Digital Input pin can be pulled high or low; thus the connected equipments can actively drive these pins high or low. The embedded software UI allows you to read and set the value to the connected device.

**The power input voltage of logic low is DC 0~10V. Logic high is DC 11~30V.**

Wire the digital input just like wiring the power input introduced in chapter 2.2.

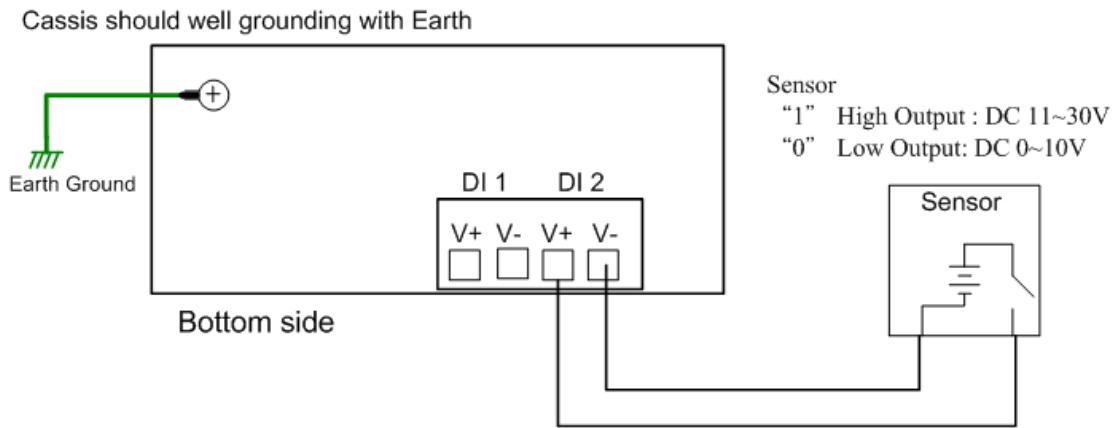

## 2.4 Wiring Digital Output

The Switch provides 2 digital outputs, also known as Relay Output. The relay contacts are energized (open) for normal operation and will close for fault conditions. The fault conditions include power failure, Ethernet port link break or other pre-defined events which can be configured in Switch's Web User Interface.

Wiring digital output is exactly the same as wiring power input introduced in chapter 2.2.

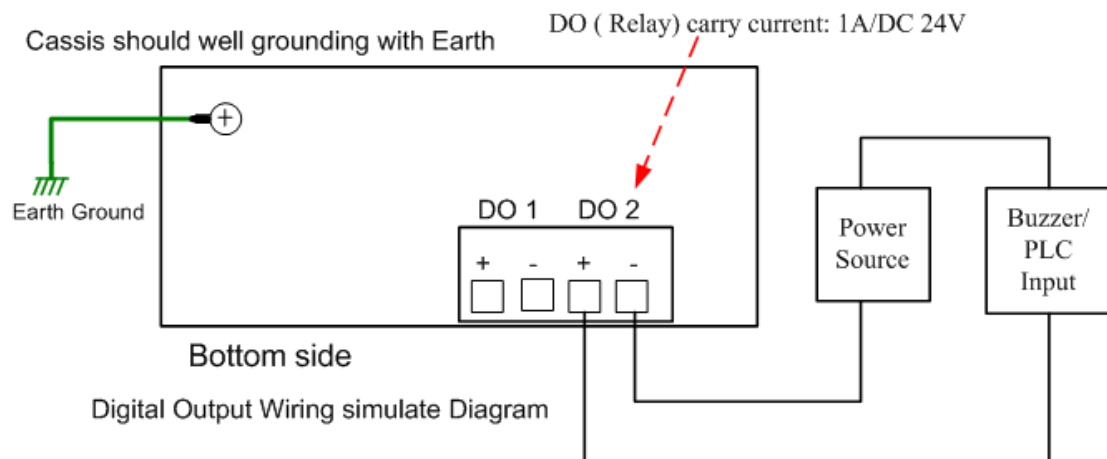

## 2.5 Wiring Earth Ground

To ensure the system will not be damaged by noise or any electrical shock, we suggest you to make exact connection between the Switch and Earth Grounding System.

On the bottom side of the Switch, there is one earth ground screw. Loosen the earth ground screw by screw drive; then tighten the screw after earth ground wire is connected.

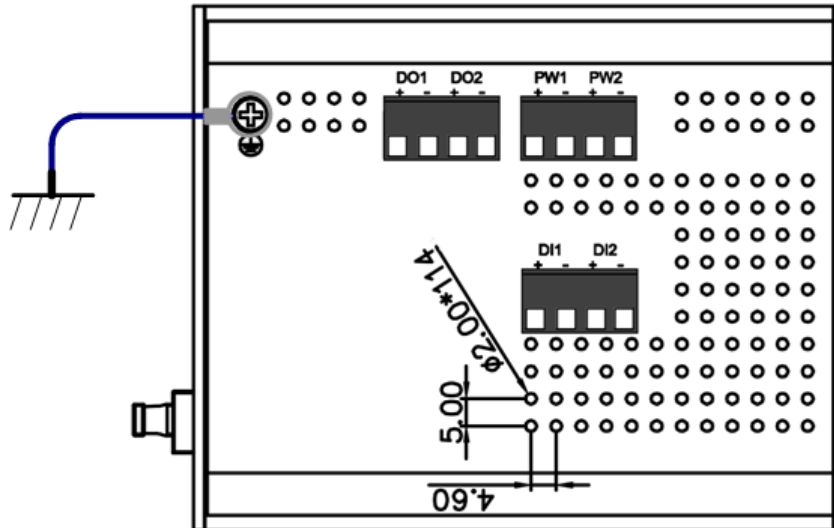

## 2.6 Wiring Fast Ethernet Ports

The Switch includes 7 RJ-45 Fast Ethernet ports. The fast Ethernet ports support 10Base-T and 100Base-TX, full or half duplex modes. All the fast Ethernet ports will auto-detect the signal from connected devices to negotiate the link speed and duplex mode. Auto MDI/MDIX allows users to connect another switch, hub or workstation without changing straight through or crossover cables.

Note that crossover cables simply cross-connect the transmit lines at each end to the received lines at the opposite end.

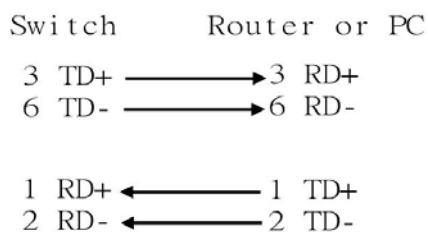

Straight-through Cabling Schematic

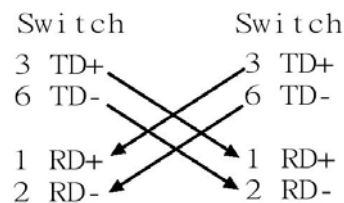

Cross-over Cabling Schematic

Note that Ethernet cables use pins 1, 2, 3, and 6 of an 8-pin RJ-45 connector. The signals of these pins are converted by the automatic MDI-X function, as shown in the table below:

Pin MDI-X	Signals	MDI Signals
1	RD+	TD+
2	RD-	TD-
3	TD+	RD+
6	TD-	RD-

Connect one side of an Ethernet cable into any switch port and connect the other side to your attached device. The LNK LED will light up when the cable is correctly connected. Refer to the **LED Indicators** section for descriptions of each LED indicator. Always make sure that the cables between the switches and attached devices (e.g. switch, hub, or

workstation) are less than 100 meters (328 feet).

The wiring cable types are as below.

10Base-T: 2-pair UTP/STP Cat. 3, 4, 5 cable, EIA/TIA-568B 100-ohm (100m)

100 Base-TX: 2-pair UTP/STP Cat. 5 cable, EIA/TIA-568B 100-ohm (100m)

1000 Base-T: 4-pair UTP/STP Cat. 5 cable, EIA/TIA-568B 100-ohm (100m)

## 2.7 Wiring Combo Ports

The Switch, 7+3G includes 3 RJ-45 Gigabit Ethernet and combo with Gigabit SFP ports. The speed of the Gigabit Ethernet RJ-45 port supports 10Base-T, 100Base-TX, 1000Base-T, and the SFP ports are combo design with RJ-45 ports. The SFP ports support Small Form Factor GBIC Transceiver (MINI GBIC) for 100Mbps and 1000Mbps.

For the 7+3 100 Switch, the 3 100 RJ-45 Ethernet are combo design with 100Mbps SFP ports, which means the SFP ports only support 100Mbps Small Form Factor GBIC Transceiver (MINI GBIC).

It is recommended using the certificated SFP Transceiver. The certificated SFP transceiver includes 100Base-FX single/multi mode, 1000Base-SX/LX single/multi mode ranging from 550m to 80KM.

**To keep best performance, the SFP fiber ports will not support Fiber Link First function anymore after firmware version v2.4b, since the SFP fiber transceiver vendor have applied energy saving technology and changed the circuit design that will cause SFP transceiver can't offer energy of fiber link signature to switches the connection from RJ-45 to fiber, even the SFP fiber transceiver already link up.**

**To fix that issue, new v2.4b firmware have applied plug-in and switch to fiber mode feature. It forced the connection change from RJ-45 to SFP immediately, once the SFP transceiver inserted and detected by CPU.**

**Note: The Ethernet Switch has to use UL recognized fiber transceiver with Class 1 Laser/LED Diode.**

**Note: It is recommended don't plug-in SFP fiber transceiver and link up RJ-45 port at same time, it might cause the connection does not work properly.**

## 2.8 Wiring RS-232 Console Cable

It attached one RS-232 DB-9 to RJ-45 cable in the box. Connect the DB-9 connector to the COM port of your PC, open Terminal tool and set up serial settings to 9600, N,8,1. (Baud Rate: 9600 / Parity: None / Data Bit: 8 / Stop Bit: 1) Then you can access CLI interface by console cable.

Note: If you lost the cable, please contact with your sales or follow the pin assignment to buy a new one. The Pin assignment spec is listed in the appendix.

## 2.9 DIN-Rail Mounting Installation

The DIN-Rail clip is already attached to the Switch when packaged. If the DIN-Rail clip is not screwed on the Switch, follow the instructions and the figure below to attach DIN-Rail clip to the Switch.

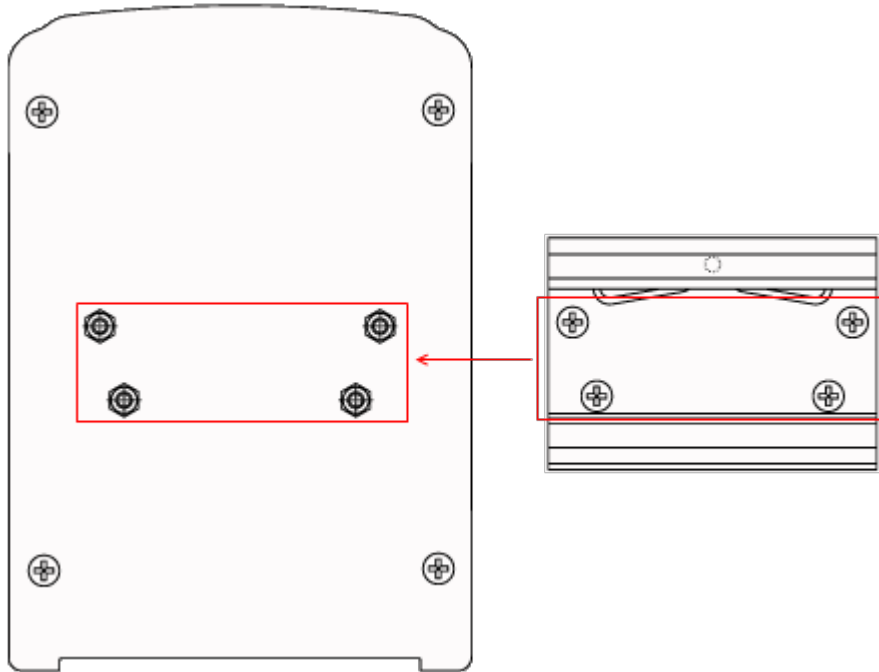

1. Use the screws to attach DIN-Rail clip to the rear panel of Switch.
2. To remove DIN-Rail clip, reverse step 1.

Follow the steps below to mount the Ethernet Switch to the DIN-Rail track:

1. First, insert the upper end of DIN-Rail clip into the back of DIN-Rail track from its upper side.

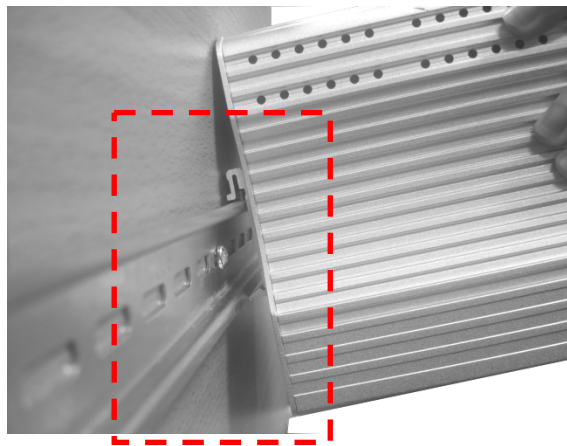

2. Lightly push the bottom of DIN-Rail clip into the track.

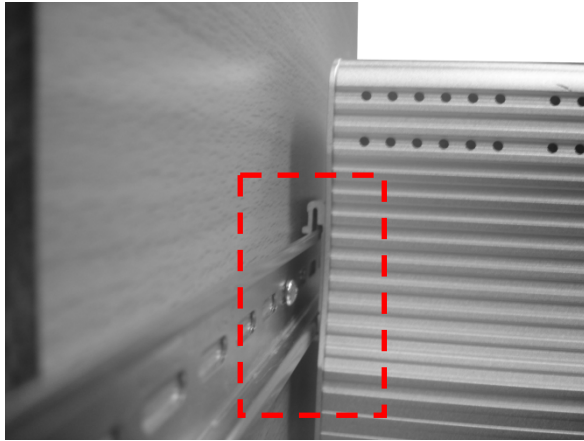

3. Check if DIN-Rail clip is tightly attached on the track.
4. To remove it from the track, reverse the steps above.

**Notes: The DIN Rail should compliance with DIN EN50022 standard.  
Using wrong DIN rail may cause system install unsafe.**



## 2.10 Wall-Mounting Installation

Follow the steps below to install the Switch with the wall mounting plate.

1. To remove DIN-Rail clip from the Switch, loosen the screws from DIN-Rail clip.
2. Place the wall mounting plate on the rear panel of Switch
3. Use the screws to tighten the wall mounting plate onto the Switch.
4. Use the hook holes at the corners of the wall mounting plate to hang the Switch onto the wall.
5. To remove the wall mounting plate, reverse the steps above.

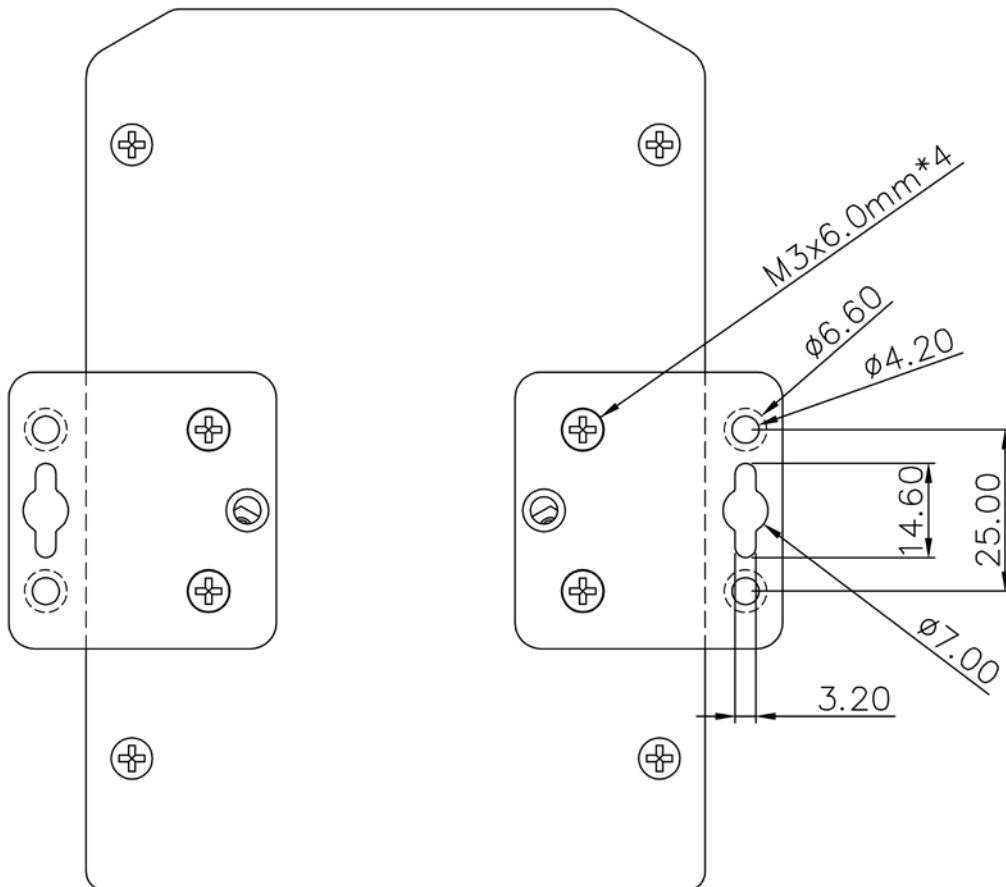

**Note:** To avoid damage the internal circuit, be sure use the screw included in the package to screw and tight the wall-mount kit onto the rear side of the JetNet switch. The specification of screw is M3 in 6 mm length.

# 3 Preparation for Management

The Industrial Managed Switch provides both in-band and out-band configuration methods. You can configure the switch via RS232 console cable if you don't attach your admin PC to your network, or if you lose network connection to your Switch. This is so-called out-band management. It wouldn't be affected by network performance.

The in-band management means you can remotely manage the switch via the network. You can choose Telnet or Web-based management. You just need to know the device's IP address and you can remotely connect to its embedded HTTP web pages or Telnet console.

Following topics are covered in this chapter:

## 3.1 Preparation for Serial Console

## 3.2 Preparation for Web Interface

## 3.3 Preparation for Telnet console

Note: It is recommended management session don't exceed 2 accounts for Web and Telnet management. Once the session exceeds 3 accounts, the system kernel may show some information in the local / telnet interface.

## 3.1 Preparation for Serial Console

In the package, Korenix attached one RS-232 DB-9 to RJ-45 console cable. Please attach RS-232 DB-9 connector to your PC COM port, connect RJ-45 to the Console port of the Switch. If you lose the cable, please follow the console cable PIN assignment to find one. (Refer to the appendix).

1. Go to Start -> Program -> Accessories -> Communication -> Hyper Terminal
2. Give a name to the new console connection.
3. Choose the COM name
4. Select correct serial settings. The serial settings of Switch are as below:  
Baud Rate: 9600 / Parity: None / Data Bit: 8 / Stop Bit: 1
5. After connected, you can see Switch login request.
6. Login the switch. The default username is "admin", password, "admin".

```
Booting...
          Sun Jan  1 00:00:00 UTC 2006

Switch login: admin
Password:

JetNet5010G (version 2.1.5-20080414-11:04:13).
Copyright 2006-2008 Korenix Technology Co., Ltd.

Switch>
```

## 3.2 Preparation for Web Interface

The Switch provides HTTP Web Interface and Secured HTTPS Web Interface for web management.

### 3.2.1 Web Interface

Korenix web management page is developed by JAVA. It allows you to use a standard web-browser such as Microsoft Internet Explorer, or Mozilla, to configure and interrogate the switch from anywhere on the network.

Before you attempt to use the embedded web interface to manage switch operation, verify that your Industrial Ethernet Switch is properly installed on your network and that every PC on this network can access the switch via the web browser.

1. Verify that your network interface card (NIC) is operational, and that your operating system supports TCP/IP protocol.
2. Wire DC power to the switch and connect your switch to your computer.
3. Make sure that the switch default IP address is 192.168.10.1.
4. Change your computer IP address to 192.168.10.2 or other IP address which is located in the 192.168.10.x (Network Mask: 255.255.255.0) subnet.
5. Switch to DOS command mode and ping 192.168.10.1 to verify a normal response time.

Launch the web browser and Login.

6. Launch the web browser (Internet Explorer or Mozilla Firefox) on the PC.
7. Type **http://192.168.10.1** (or the IP address of the switch). And then press **Enter**.
8. The login screen will appear next.
9. Key in user name and the password. Default user name and password are both **admin**.
10. Select Language type, this feature is available from **firmware v2.5** that supports **English** and **Simplified Chinese**.



Click on **Enter** or **OK**. Welcome page of the web-based management interface will then appear.

欢迎来到 JetNet5010G  
工业管理型交换机

Simplified Chinese Language

系统名称	Switch
系统位置	
系统联系	
系统OID	1.3.6.1.4.1.24062.2.2.1
系统描述	JetNet5010G Industrial Managed Switch
固件版本	v2.4.7 20110829
设备MAC	00:12:77:ff:00:00

Copyright (c) 2006-2011 Korenix Technology Co., Ltd.. All Rights Reserved.

Welcome to the JetNet5010G  
Industrial Managed Switch

English language

System Name	Switch
System Location	
System Contact	
System OID	1.3.6.1.4.1.24062.2.2.1
System Description	JetNet5010G Industrial Managed Switch
Firmware Version	v2.1.5 20080414
Device MAC	00:12:77:60:14:11

Copyright (c) 2006-2008 Korenix Technology Co., Ltd.. All Rights Reserved. [按一下以啓動和使用此控制項](#)

Once you enter the web-based management interface, you can freely change the JetNet's IP address to fit your network environment.

**Note 1:** IE 5.0 or later versions do not allow Java applets to open sockets by default. Users have to directly modify the browser settings to selectively enable Java applets to use network ports.

**Note 2:** The Web UI connection session of the Switch will be logged out automatically if you don't give any input after 30 seconds. After logged out, you should re-login and key in correct user name and password again.

### 3.2.2 Secured Web Interface

Korenix web management page also provides secured management HTTPS login. All the configuration commands will be secured and will be hard for the hackers to sniff the login password and configuration commands.

Launch the web browser and Login.

1. Launch the web browser (Internet Explorer or Mozilla Firefox) on the PC.
2. Type **https://192.168.10.1** (or the IP address of the switch). And then press **Enter**.

3. The popup screen will appear and request you to trust the secured HTTPS connection distributed by the Switch first. Press “Yes” to trust it.



4. The login screen will appear next.



5. Key in the user name and the password. The default user name and password is **admin**.
6. Click on **Enter** or **OK**. Welcome page of the web-based management interface will then appear.
7. Once you enter the web-based management interface, all the commands you see are the same as what you see by HTTP login.

## 3.3 Preparation for Telnet Console

### 3.3.1 Telnet

The Switch supports Telnet console. You can connect to the switch by Telnet and the command lines are the same as what you see by RS232 console port. Below are the steps to open Telnet connection to the switch.

1. Go to Start -> Run -> cmd. And then press **Enter**
2. Type the **Telnet 192.168.10.1** (or the IP address of the switch). And then press **Enter**

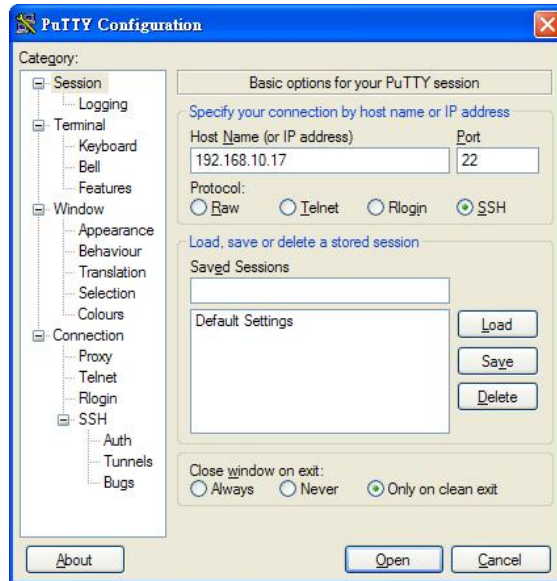

### 3.3.2 SSH (Secure Shell)

The Switch also support SSH console. You can remotely connect to the switch by command line interface. The SSH connection can secure all the configuration commands you sent to the switch.

SSH is a client/server architecture while the Switch is the SSH server. When you want to make SSH connection with the switch, you should download the SSH client tool first.

#### SSH Client

There are many free, sharewares, trials or charged SSH clients you can find on the internet. Fox example, PuTTY is a free and popular Telnet/SSH client. We'll use this tool to demonstrate how to login JetNet by SSH. Note: *PuTTY is copyright 1997-2006 Simon Tatham.*

**Download PuTTY:** <http://www.chiark.greenend.org.uk/~sgtatham/putty/download.html>

The copyright of **PuTTY**

#### 1. Open SSH Client/PuTTY

In the **Session** configuration, enter the **Host Name** (IP Address of your Switch) and **Port number** (default = 22). Choose the **"SSH"** protocol. Then click on **"Open"** to start the SSH session console.

2. After click on **Open**, then you can see the cipher information in the popup screen. Press **Yes** to accept the Security Alert.

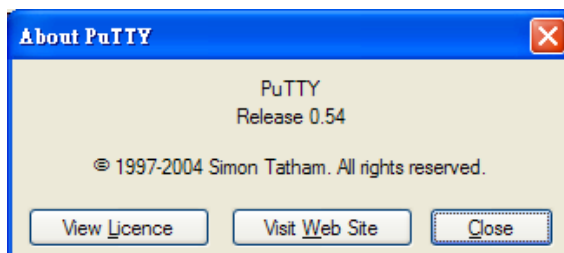

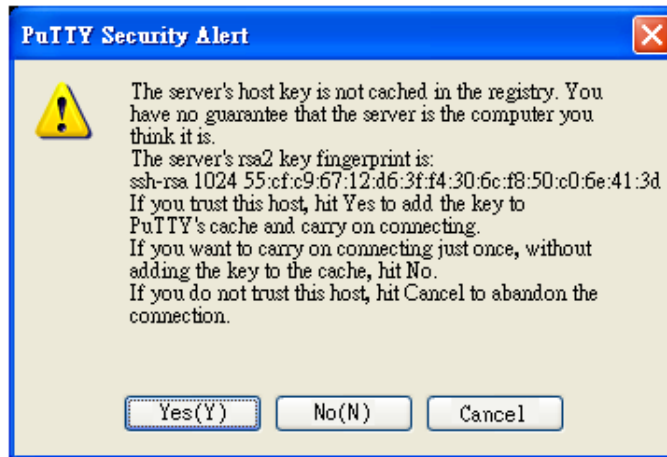

3. After few seconds, the SSH connection is opened. You can see the login screen as the below figure.

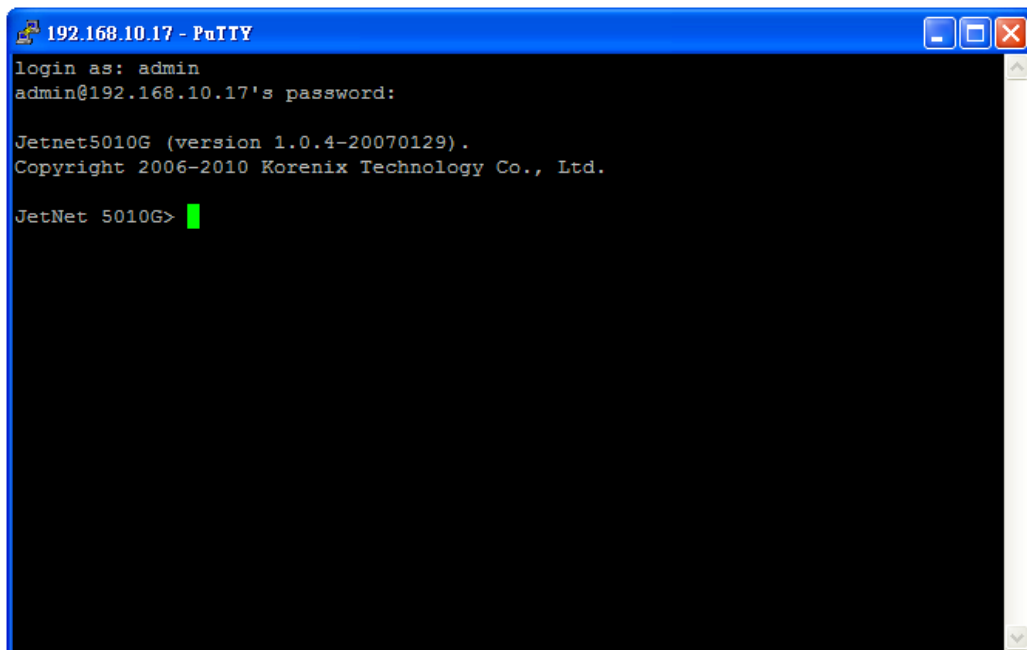

4. Type the Login Name and its Password. The default Login Name and Password are **admin / admin**.
5. All the commands you see in SSH are the same as the CLI commands you see via RS232 console. The next chapter will introduce in detail how to use command line to configure the switch.

# 4 Feature Configuration

This chapter explains how to configure Switch's software features. There are four ways to access the switch: Serial console, Telnet, Web browser and SNMP.

The Industrial Managed Switch provides both in-band and out-band configuration methods. You can configure the switch via RS232 console cable if you don't attach your admin PC to your network, or if you lose the network connection to your Switch. This is so-called out-band management. It wouldn't be affected by the network performance.

The in-band management means you can remotely manage the switch via the network. You can choose Telnet or Web-based management. You just need to know the device's IP address. Then you can remotely connect to its embedded HTML web pages or Telnet console.

Korenix web management page is developed by JAVA. It allows you to use a standard web-browser such as Microsoft Internet Explorer, or Mozilla, to configure and interrogate the switch from anywhere on the network.

**Note:** IE 5.0 or later versions do not allow Java applets to open sockets by default. Users have to directly modify the browser settings to selectively enable Java applets to use network ports.

Following topics are covered in this chapter:

- 4.1 Command Line Interface (CLI) Introduction
- 4.2 Basic Setting
- 4.3 Port Configuration
- 4.4 Network Redundancy
- 4.5 VLAN
- 4.6 Traffic Prioritization
- 4.7 Multicast Filtering
- 4.8 SNMP
- 4.9 Security
- 4.10 Warning
- 4.11 Monitor and Diag
- 4.12 Device Front Panel
- 4.13 Save
- 4.14 Logout



## 4.1 Command Line Interface Introduction

The Command Line Interface (CLI) is the user interface to the switch's embedded software system. You can view the system information, show the status, configure the switch and receive a response back from the system by keying in a command.

There are some different command modes. Each command mode has its own access ability, available command lines and uses different command lines to enter and exit. These modes are User EXEC, Privileged EXEC, Global Configuration, (Port/VLAN) Interface Configuration modes.

**User EXEC** mode: As long as you login the switch by CLI. You are in the User EXEC mode. You can ping, telnet remote device, and show some basic information.

Type **enable** to enter next mode, **exit** to logout. **?** to see the command list

<b>Switch&gt;</b>	
enable	Turn on privileged mode command
exit	Exit current mode and down to previous mode
list	Print command list
ping	Send echo messages
quit	Exit current mode and down to previous mode
show	Show running system information
telnet	Open a telnet connection
traceroute	Trace route to destination

**Privileged EXEC** mode: Press enable in the User EXEC mode, then you can enter the Privileged EXEC mode. In this mode, the system allows you to view current configuration, reset default, reload switch, show system information, save configuration...and enter the global configuration mode.

Type **configure terminal** to enter next mode, **exit** to leave. **?** to see the command list

<b>Switch#</b>	
archive	manage archive files
clear	Reset functions
clock	Configure time-of-day clock
configure	Configuration from vty interface
copy	Copy from one file to another
debug	Debugging functions (see also 'undebug')
disable	Turn off privileged mode command
end	End current mode and change to enable mode
exit	Exit current mode and down to previous mode
list	Print command list
more	Display the contents of a file
no	Negate a command or set its defaults
ping	Send echo messages
quit	Exit current mode and down to previous mode
reboot	Reboot system
reload	copy a default-config file to replace the current one
show	Show running system information
telnet	Open a telnet connection
terminal	Set terminal line parameters
traceroute	Trace route to destination
write	Write running configuration to memory, network, or terminal

**Global Configuration Mode:** Press **configure terminal** in privileged EXEC mode. You can then enter global configuration mode. In global configuration mode, you can configure all the features that the system provides you.

Type **interface IFNAME/VLAN** to enter interface configuration mode, **exit** to leave. **?** to see the command list.

Available command lists of global configuration mode.

Switch#	configure terminal	
Switch(config)#		
administrator		Administrator account setting
arp		Set a static ARP entry
auth		Authentication
clock		Configure time-of-day clock
default		Set a command to its defaults
dot1x		IEEE 802.1x standard access security control
end		End current mode and change to enable mode
erps		Ethernet Ring Protection Switching (ITU-T G.8032)
ethernet-ip		Ethernet/IP Protocol
ethertype		Ethertype
exit		Exit current mode and down to previous mode
grp		GARP VLAN Registration Protocol
hostname		Set system's network name
interface		Select an interface to configure
ip		IP information
ipv6		IP information
jetview		JetView Protocol
lacp		Link Aggregation Control Protocol
list		Print command list
lldp		Link Layer Discovery Protocol
log		Logging control
loop-protect		Ethernet loop protection
mac-address-table		mac address table
mirror		Port mirroring
modbus		Modbus TCP Slave
multiple-super-ring		Configure Multiple Super Ring
nameserver		DNS Server
no		Negate a command or set its defaults
ntp		Configure NTP
qos		Quality of Service (QoS)
relay		relay output type information
router		Enable a routing process
service		System service
sfp		Small form-factor pluggable
smtp-server		SMTP server configuration
snmp-server		the SNMP server
spanning-tree		the spanning tree algorithm
trunk		Trunk group configuration
vlan		Virtual LAN
warning-event		Warning event selection
write-config		Specify config files to write to

**(Port) Interface Configuration:** Press **interface IFNAME** in global configuration mode. You can then enter interface configuration mode. In this mode, you can configure port

settings.

The port interface's code name for fast Ethernet port 1 is fa1, and fast Ethernet 7 is fa7, gigabit Ethernet port 8 is gi8, the gigabit Ethernet port 10 is gi10. Type in the interface's code name accordingly when you want to enter certain interface configuration mode.

Type " **exit**" to leave.

Type "?" to see the command list

Available command lists of the global configuration mode.

Switch(config)# interface fa1	
Switch(config-if)#	
acceptable	Configure 802.1Q acceptable frame types of a port.
auto-negotiation	Enable auto-negotiation state of a given port
description	Interface specific description
duplex	Specify duplex mode of operation for a port
end	End current mode and change to enable mode
exit	Exit current mode and down to previous mode
flowcontrol	Set flow-control value for an interface
garp	General Attribute Registration Protocol
ingress	802.1Q ingress filtering features
lACP	Link Aggregation Control Protocol
list	Print command list
loopback	Specify loopback mode of operation for a port
mac	MAC interface commands
mdix	Enable mdix state of a given port
no	Negate a command or set its defaults
qos	Quality of Service (QoS)
quit	Exit current mode and down to previous mode
rate-limit	Rate limit configuration
shutdown	Shutdown the selected interface
spanning-tree	spanning-tree protocol
speed	Specify the speed of a Fast Ethernet port or a Gigabit Ethernet port.
switchport	Set switching mode characteristics

**(VLAN) Interface Configuration:** Press **interface VLAN VLAN-ID** in global configuration mode. You can then enter VLAN interface configuration mode. In this mode, you can configure the settings for the specific VLAN.

The VLAN interface name of VLAN 1 is VLAN 1, VLAN 2 is VLAN 2...

Type **exit** to leave the mode. Type **?** to see the available command list.

The command lists of the VLAN interface configuration mode.

```
Switch(config)# interface vlan 1
Switch(config-if)#
  description  Interface specific description
  end          End current mode and change to enable mode
  exit        Exit current mode and down to previous mode
  ip          Interface Internet Protocol config commands
  list        Print command list
  no          Negate a command or set its defaults
  quit        Exit current mode and down to previous mode
  shutdown    Shutdown the selected interface
```

Summary of the 5 command modes.

Command Mode	Main Function	Enter and Exit Method	Prompt
User EXEC	This is the first level of access. User can ping, telnet remote device, and show some basic information	Enter: <b>Login</b> successfully Exit: <b>exit</b> to logout. Next mode: Type <b>enable</b> to enter privileged EXEC mode.	Switch>
Privileged EXEC	In this mode, the system allows you to view current configuration, reset default, reload switch, show system information, save configuration...and enter global configuration mode.	Enter: Type <b>enable</b> in User EXEC mode. Exec: Type <b>disable</b> to exit to user EXEC mode. Type <b>exit</b> to logout Next Mode: Type <b>configure terminal</b> to enter global configuration command.	Switch#
Global configuration	In global configuration mode, you can configure all the features that the system provides you	Enter: Type <b>configure terminal</b> in privileged EXEC mode Exit: Type <b>exit</b> or <b>end</b> or press <b>Ctrl-Z</b> to exit.	Switch(config)#

		Next mode: Type <b>interface IFNAME/ VLAN VID</b> to enter interface configuration mode	
Port Interface configuration	In this mode, you can configure port related settings.	Enter: Type <b>interface IFNAME</b> in global configuration mode. Exit: Type <b>exit</b> or <b>Ctrl+Z</b> to global configuration mode. Type <b>end</b> to privileged EXEC mode.	Switch(config-if)#
VLAN Interface Configuration	In this mode, you can configure settings for specific VLAN.	Enter: Type <b>interface VLAN VID</b> in global configuration mode. Exit: Type <b>exit</b> or <b>Ctrl+Z</b> to global configuration mode. Type <b>end</b> to privileged EXEC mode.	Switch(config-vlan)#

Here are some useful commands for you to see these available commands. Save your time in typing and avoid typing error.

? To see all the available commands in this mode. It helps you to see the next command you can/should type as well.

```
Switch(config)# interface (?)
IFNAME  Interface's name
vlan    Select a vlan to configure
```

(Character)? To see all the available commands starts from this character.

```
Switch(config)# a?
access-list  Add an access list entry
administrator Administrator account setting
arp          Set a static ARP entry
```

Tab This tab key helps you to input the command quicker. If there is only one available command in the next, clicking on tab key can help to finish typing soon.

```
Switch# co (tab) (tab)
Switch# configure terminal

Switch(config)# ac (tab)
Switch(config)# access-list
```

Ctrl+C To stop executing the unfinished command.

Ctrl+S To lock the screen of the terminal. You can't input any command.

Ctrl+Q To unlock the screen which is locked by Ctrl+S.

Ctrl+Z To exit configuration mode.

Alert message when multiple users want to configure the switch. If the administrator is in configuration mode, then the Web users can't change the settings. The Switch allows only one administrator to configure the switch at a time.

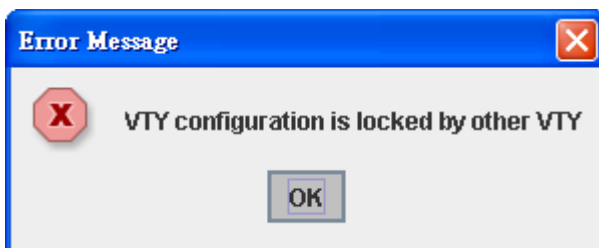

## 4.2 Basic Setting

The Basic Setting group provides you to configure switch information, IP address, User name/Password of the system. It also allows you to do firmware upgrade, backup and restore configuration, reload factory default, and reboot the system.

Following commands are included in this group:

- 4.2.1 Switch Setting
- 4.2.2 Admin Password
- 4.2.3 IP Configuration
- 4.2.4 Time Setting
- 4.2.5 DHCP Server
- 4.2.6 Backup and Restore
- 4.2.7 Firmware Upgrade
- 4.2.8 Factory Default
- 4.2.9 System Reboot
- 4.2.10 CLI Commands for Basic Setting

### 4.2.1 Switch Setting

You can assign System name, Location, Contact and view system information.

Figure 4.2.1.1 – Web UI of the Switch Setting

Field	Value
System Name	JetNet 5010G
System Location	
System Contact	
System OID	1.3.6.1.2.24062.2.1.3
System Description	JetNet 5010G Industrial Managed Switch
Firmware Version	v1.2 20070620
Device MAC	00:12:77:ff:00:00

Apply

**System Name:** You can assign a name to the device. The available characters you can input is 64. After you configure the name, CLI system will select the first 12 characters as the name in CLI system.

**System Location:** You can specify the switch's physical location here. The available characters you can input are 64.

**System Contact:** You can specify contact people here. You can type the name, mail address or other information of the administrator. The available characters you can input are 64.

**System OID:** The SNMP object ID of the switch. You can follow the path to find its private MIB in MIB browser. (**Note:** When you attempt to view private MIB, you should compile private MIB files into your MIB browser first.)

**System Description:** the name of this Switch.

**Firmware Version:** Display the firmware version installed in this device.

**MAC Address:** Display unique hardware address (MAC address) assigned by the manufacturer.

Once you finish the configuration, click on **Apply** to apply your settings.

**Note:** Always remember to select **Save** to save your settings. Otherwise, the settings you made will be lost when the switch is powered off.

#### 4.2.2 Admin Password

You can change the user name and the password here to enhance security

Figure 4.2.2.1 Web UI of the Admin Password



The screenshot shows a web interface titled "Your Industrial Computing" with a sub-header "Admin Password". It contains three input fields: "Name" with the value "admin", "Password" with "\*\*\*\*\*", and "Confirm Password" with "\*\*\*\*\*". Below the fields is an "Apply" button.

**User name:** You can key in new user name here. The default setting is **admin**.

**Password:** You can key in new password here. The default setting is **admin**.

**Confirm Password:** You need to type the new password again to confirm it.

Once you finish configuring the settings, click on **Apply** to apply your configuration.

Figure 4.2.2.2 Popup alert window for Incorrect Username.

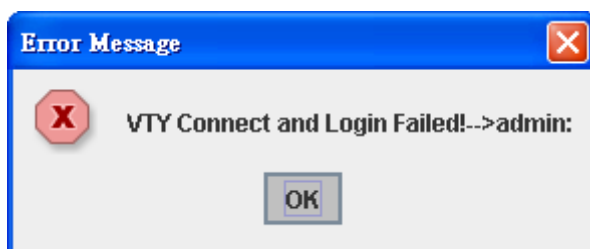



### 4.2.3 IP Configuration

This function allows users to configure the switch's IP address settings.

IP Configuration	
DHCP Client	Disable
IP Address	192.168.0.48
Subnet Mask	255.255.255.0
Default Gateway	192.168.10.254
<input type="button" value="Apply"/>	

**DHCP Client:** You can select to **Enable** or **Disable** DHCP Client function. When DHCP Client function is enabled, an IP address will be assigned to the switch from the network's DHCP server. In this mode, the default IP address will therefore be replaced by the one assigned by DHCP server. If DHCP Client is disabled, then the IP address that you specified will be used instead.

**IP Address:** You can assign the IP address reserved by your network for your JetNet. If DHCP Client function is enabled, you don't need to assign an IP address to the JetNet, as it will be overwritten by DHCP server and shown here. The default IP is 192.168.10.1.

**Subnet Mask:** You can assign the subnet mask for the IP address here. If DHCP Client function is enabled, you don't need to assign the subnet mask. The default Subnet Mask is 255.255.255.0. **Note:** In the CLI, we use the enabled bit of the subnet mask to represent the number displayed in web UI. For example, 8 stands for 255.0.0.0; 16 stands for 255.255.0.0; 24 stands for 255.255.255.0.

**Default Gateway:** You can assign the gateway for the switch here. The default gateway is 192.168.10.254.

**Note:** In CLI, we use 0.0.0.0/0 to represent for the default gateway.

Once you finish configuring the settings, click on **Apply** to apply your configuration.

**IPv6 Configuration** –An IPv6 address is represented as eight groups of four hexadecimal digits, each group representing 16 bits (two octets). The groups are separated by colons (:), and the length of IPv6 address is 128bits.

An example of an IPv6 address is: 2001:0db8:85a3:0000:0000:8a2e:0370:7334.

The default IP address of JetNet Managed Switch is fe80:0:0:0:212:77ff:fe60:ce8c, and the Leading zeroes in a group may be omitted. Thus, the example address may be written as: fe80::212:77ff:fe60:ce8c.

IPv6 Configuration	
IPv6 Address	Prefix
<input type="button" value="Add"/>	
fe80::212:77ff:fe60:ce8c	64
<input type="button" value="Remove"/> <input type="button" value="Reload"/>	

**IPv6 Address field:** typing new IPv6 address in this field.

**Prefix:** the size of subnet or network, and it equivalent to the subnetmask, but written in different. The default subnet mask length is 64bits, and written in decimal value - 64.

**Add:** after add new IPv6 address and prefix, don't forget click icon -"Add" to apply new address to system.

**Remove:** select existed IPv6 address and click icon -"Remove" to delete IP address.

**Reload:** refresh and reload IPv6 address listing.

**IPv6 Neighbor Table:** shows the IPv6 address of neighbor, connected interface, MAC address of remote IPv6 device, and current state of neighbor device.

IPv6 Neighbor Table			
Neighbor	Interface	MAC address	State

Reload

The system will update IPv6 Neighbor Table automatically, and user also can click the icon "Reload" to refresh the table.

#### 4.2.4 Time Setting

Time Setting source allow user to set the time manually or through NTP server. Network

Time Protocol (NTP) is used to synchronize computer clocks on the internet. You can configure NTP settings here to synchronize the clocks of several switches on the network.

The Switch also provides Daylight Saving function.

### Time Setting

System Time: Tue Jan 1 00:21:01 2008

**Time Setting Source** Manual Setting

Manual Setting

Jan 01, 2008 00:21:01

**Timezone Setting**

Timezone (GMT) Greenwich Mean Time: Dublin, Edinburgh, Lisbon, London

**Daylight Saving Time**

Daylight Saving Start 1st Sun in Jan at 00:00

Daylight Saving End 1st Sun in Jan at 00:00

Apply

**Manual Setting:** User can select Manual setting to change time as user wants. User also can click the button "Get Time from PC" to get PC's time setting for switch.

**NTP client:** Select the Time Setting Source to NTP client can let device enable the NTP client service. NTP client will be automatically enabled if you change Time source to NTP

Client. The system will send request packet to acquire current time from the NTP server you assigned.

<b>Time Setting Source</b>	NTP Client
NTP Client	Manual Setting
Primary Server Address	NTP Client
	192.168.10.120
Secondary Server Address	192.168.10.121

**Time-zone:** Select the time zone where the switch is located. Following table lists the time zones for different locations for your reference. The default time zone is GMT Greenwich Mean Time.

```
Switch(config)# clock timezone
01 (GMT-12:00) Eniwetok, Kwajalein
02 (GMT-11:00) Midway Island, Samoa
03 (GMT-10:00) Hawaii
04 (GMT-09:00) Alaska
05 (GMT-08:00) Pacific Time (US & Canada) , Tijuana
06 (GMT-07:00) Arizona
07 (GMT-07:00) Mountain Time (US & Canada)
08 (GMT-06:00) Central America
09 (GMT-06:00) Central Time (US & Canada)
10 (GMT-06:00) Mexico City
11 (GMT-06:00) Saskatchewan
12 (GMT-05:00) Bogota, Lima, Quito
13 (GMT-05:00) Eastern Time (US & Canada)
14 (GMT-05:00) Indiana (East)
15 (GMT-04:00) Atlantic Time (Canada)
16 (GMT-04:00) Caracas, La Paz
17 (GMT-04:00) Santiago
18 (GMT-03:00) Newfoundland
19 (GMT-03:00) Brasilia
20 (GMT-03:00) Buenos Aires, Georgetown
21 (GMT-03:00) Greenland
22 (GMT-02:00) Mid-Atlantic
23 (GMT-01:00) Azores
24 (GMT-01:00) Cape Verde Is.
25 (GMT) Casablanca, Monrovia
26 (GMT) Greenwich Mean Time: Dublin, Edinburgh, Lisbon, London
27 (GMT+01:00) Amsterdam, Berlin, Bern, Rome, Stockholm, Vienna
28 (GMT+01:00) Belgrade, Bratislava, Budapest, Ljubljana, Prague
29 (GMT+01:00) Brussels, Copenhagen, Madrid, Paris
30 (GMT+01:00) Sarajevo, Skopje, Sofija, Vilnius, Warsaw, Zagreb
31 (GMT+01:00) West Central Africa
32 (GMT+02:00) Athens, Istanbul, Minsk
33 (GMT+02:00) Bucharest
34 (GMT+02:00) Cairo
35 (GMT+02:00) Harare, Pretoria
36 (GMT+02:00) Helsinki, Riga, Tallinn
37 (GMT+02:00) Jerusalem
38 (GMT+03:00) Baghdad
39 (GMT+03:00) Kuwait, Riyadh
```

- 40 (GMT+03:00) Moscow, St. Petersburg, Volgograd
- 41 (GMT+03:00) Nairobi
- 42 (GMT+03:30) Tehran
- 43 (GMT+04:00) Abu Dhabi, Muscat
- 44 (GMT+04:00) Baku, Tbilisi, Yerevan
- 45 (GMT+04:30) Kabul
- 46 (GMT+05:00) Ekaterinburg
- 47 (GMT+05:00) Islamabad, Karachi, Tashkent
- 48 (GMT+05:30) Calcutta, Chennai, Mumbai, New Delhi
- 49 (GMT+05:45) Kathmandu
- 50 (GMT+06:00) Almaty, Novosibirsk
- 51 (GMT+06:00) Astana, Dhaka
- 52 (GMT+06:00) Sri Jayawardenepura
- 53 (GMT+06:30) Rangoon
- 54 (GMT+07:00) Bangkok, Hanoi, Jakarta
- 55 (GMT+07:00) Krasnoyarsk
- 56 (GMT+08:00) Beijing, Chongqing, Hong Kong, Urumqi
- 57 (GMT+08:00) Irkutsk, Ulaan Bataar
- 58 (GMT+08:00) Kuala Lumpur, Singapore
- 59 (GMT+08:00) Perth
- 60 (GMT+08:00) Taipei
- 61 (GMT+09:00) Osaka, Sapporo, Tokyo
- 62 (GMT+09:00) Seoul
- 63 (GMT+09:00) Yakutsk
- 64 (GMT+09:30) Adelaide
- 65 (GMT+09:30) Darwin
- 66 (GMT+10:00) Brisbane
- 67 (GMT+10:00) Canberra, Melbourne, Sydney
- 68 (GMT+10:00) Guam, Port Moresby
- 69 (GMT+10:00) Hobart
- 70 (GMT+10:00) Vladivostok
- 71 (GMT+11:00) Magadan, Solomon Is., New Caledonia
- 72 (GMT+12:00) Auckland, Wellington
- 73 (GMT+12:00) Fiji, Kamchatka, Marshall Is.
- 74 (GMT+13:00) Nuku'alofa

**Daylight Saving Time:** click the check box to enable the Daylight Saving Function as the setting of start and end time or disable it.

**Daylight Saving Start** and **Daylight Saving End:** the time setting allows user to select the week that monthly basis, and sets the End and Start time individually.

<input type="checkbox"/> <b>Daylight Saving Time</b>													
Daylight Saving Start	1st	▼	Sun	▼	in	Jan	▼	at	00	▼	:	00	▼
Daylight Saving End	1st	▼	Sun	▼	in	Jan	▼	at	00	▼	:	00	▼
<input type="button" value="Apply"/>													

Once you finish those configurations, click on **Apply** to apply your configuration..

#### 4.2.5 DHCP Server

The DHCP Server session includes **DHCP server configuration, Leased Entries** and **DHCP Relay Agent** parts that allowed user to configure and maintain the DHCP function.

##### DHCP Server configuration

After selecting to enable DHCP Server function, type in the Network IP address for the DHCP server IP pool, Subnet Mask, Default Gateway address and Lease Time for client.

Once you have finished the configuration, click **Apply** to apply your configuration

##### Excluded Address:

You can type a specific address into the **IP Address field** for the DHCP server reserved IP address.

The IP address that is listed in the **Excluded Address List Table** will not be assigned to the network device. Add or remove an IP address from the **Excluded Address List** by clicking **Add** or **Remove**.

**DHCP Server** Enable

**DHCP Server Configuration**

Network	192.168.10.0
Subnet Mask	255.255.255.0
Default Gateway	192.168.10.1
Lease Time(s)	604800

Apply

**Excluded Address List**

Index	IP Address
1	192.168.10.200

Remove

**Manual Binding:** the Switch provides a MAC address and IP address binding and removing function. You can type in the specified IP and MAC address, then click **Add** to add a new MAC&IP address binding rule for a specified link partner, like PLC or any device without **DHCP client** function. To remove from the binding list, just select the rule to remove and click **Remove**.

**Manual Binding**

IP Address

MAC Address

Add

**Manual Binding List**

Index	IP Address	MAC Address
-------	------------	-------------

Remove

**DHCP Leased Entries:** It provides an assigned IP address list for user check. It will show the MAC and IP address that was assigned by the Switch. Click the **Reload** button to refresh the listing.

**DHCP Leased Entries**

Index	Binding	IP Address	MAC Address	Lease Time(s)
1	Auto	192.168.0.3	0012.77ff.0530	604785

Reload

## DHCP Relay Agent

You can select to **Enable** or **Disable** DHCP relay agent function, and then select the modification type of option 82 field.

**Relay policy drop:** Drops the option 82 field and do not add any option 82 field.

**Relay policy keep:** Keeps the original option 82 field and forwards to server.

**Relay policy replace:** Replaces the existing option 82 field and adds new option 82 field. (This is the default setting)

**Helper Address:** there are 4 fields for the

DHCP server's IP address. You can fill the field with preferred IP address of DHCP Server, and then click "Apply" to activate the DHCP relay agent function. All the DHCP packets from client will be modified by the policy and forwarded to DHCP server through the gateway port.

The screenshot shows the 'DHCP Relay Agent' configuration page. At the top, the title 'DHCP Relay Agent' is displayed in blue. Below the title, there are two main sections: 'Relay Agent' and 'Relay Policy'. The 'Relay Agent' section has a dropdown menu currently set to 'Enable'. The 'Relay Policy' section has three radio button options: 'Relay policy drop' (which is selected), 'Relay policy keep', and 'Relay policy replace'. Below these options are four input fields labeled 'Helper Address 1' through 'Helper Address 4', each with a text box. At the bottom of the form is a grey 'Apply' button.

### 4.2.6 Backup and Restore

With Backup command, you can save current configuration file saved in the switch's flash to admin PC or TFTP server. This will allow you to go to **Restore** command later to restore the configuration file back to the switch. Before you restore the configuration file, you must place the backup configuration file in the PC or TFTP server. The switch will then download this file back to the flash.

There are 2 modes for users to backup/restore the configuration file, Local File mode and TFTP Server mode.

**Local File** mode: In this mode, the switch acts as the file server. Users can browse the target folder and then type the file name to backup the configuration. Users can also browse the target folder and select existed configuration file to restore the configuration back to the switch. This mode is only provided by Web UI while CLI is not supported.

**TFTP Server** mode: In this mode, the switch acts as TFTP client. Before you do so, make sure that your TFTP server is ready. Then please type the IP address of TFTP Server and Backup configuration file name. This mode can be used in both CLI and Web UI.

**TFTP Server IP Address:** You need to key in the IP address of your TFTP Server here.

**Backup/Restore File Name:** Please type the correct file name of the configuration file..

**Configuration File:** The configuration file of the switch is a pure text file. You can open it by word/txt read file. You can also modify the file, add/remove the configuration settings, and then restore back to the switch.

**Startup Configuration File:** After you saved the running-config to flash, the new settings will be kept and work after power cycle. You can use *show startup-config* to view it in CLI. The Backup command can only backup such configuration file to your PC or TFTP server.

#### **Technical Tip:**

**Default Configuration File:** The switch provides the default configuration file in the system. You can use *Reset* button, *Reload* command to reset the system.

**Running Configuration File:** The switch's CLI allows you to view the latest settings running by the system. The information shown here is the settings you set up but haven't saved to flash. The settings not yet saved to flash will not work after power recycle. You can use *show running-config* to view it in CLI.

Once you finish selecting and configuring the settings, click on **Backup** or **Restore** to run

Figure 4.2.6.1 Main UI of Backup & Restore

**Backup & Restore**

**Backup Configuration** Local File

Backup File Name D:\TFTP\backup.con

Backup

**Restore Configuration** TFTP Server

TFTP Server IP 192.168.0.100

Restore File Name backup.conf

Restore

Figure 4.2.6.2 Backup/Restore Configuration - Local File mode.

**Backup Configuration** Local File

Backup File Name 0.30w0.30\Quagga1.conf

Backup Help

Click on Folder icon to select the target file you want to backup/restore.

**Note** that the folders of the path to the target file do not allow you to input space key.

Figure 4.2.6.3 Backup/Restore Configuration - TFTP Server mode

**Backup Configuration** TFTP Server

TFTP Server IP 192.168.0.100

Backup File Name Backup1.conf

Backup

Type the IP address of TFTP Server IP. Then click on **Backup/Restore**.

**Note:** point to the wrong file will cause the entire configuration missed

#### 4.2.7 Firmware Upgrade

In this section, you can update the latest firmware for your switch. Korenix provides the latest firmware in Korenix Web site. The new firmware may include new features, bug fixes or other software changes. We'll also provide the release notes for the update as well. For technical viewpoint, we suggest you use the latest firmware before installing the switch to the customer site.

**Note that the system will be automatically rebooted after you finished upgrading new firmware. Please remind the attached users before you do this.**

Figure 4.2.7.1 Main UI of Firmware Upgrade

**Firmware Upgrade**

System Firmware Version: v1.2  
System Firmware Date: 20070620

**Firmware Upgrade** Local File ▼

Firmware File Name TPJetNet5010G-v1.2.bin

Note: When firmware upgrade is finished, the switch will restart automatically.

Upgrade

There are 2 modes for users to backup/restore the configuration file, Local File mode and TFTP Server mode.

**Local File** mode: In this mode, the switch acts as the file server. Users can browse the target folder and then type the file name to backup the configuration. Users also can browse the target folder and select the existed configuration file to restore the configuration back to the switch. This mode is only provided by Web UI while CLI is not supported.

**TFTP Server** mode: In this mode, the switch acts as the TFTP client. Before you do so, make sure that your TFTP server is ready. And then please type the IP address of TFTP Server IP address. This mode can be used in both CLI and Web UI.

**TFTP Server IP Address:** You need to key in the IP address of your TFTP Server here.

**Firmware File Name:** The file name of the new firmware.

The UI also shows you the current firmware version and built date of current firmware. Please check the version number after the switch is rebooted.

Figure 4.2.7.2 Firmware Upgrade - Local File mode.

**Firmware Upgrade**

System Firmware Version: v1.2  
System Firmware Date: 20070620

**Firmware Upgrade** Local File ▼

Firmware File Name TPJetNet5010G-v1.2.bin

Note: When firmware upgrade is finished, the switch will restart automatically.

Upgrade

Click on the Folder icon to select the target firmware file you want to upgrade.

Figure 4.2.7.3 Firmware Upgrade – TFTP Server mode.



**Firmware Upgrade**

System Firmware Version: v1.2  
System Firmware Date: 20070620

**Firmware Upgrade** TFTP Server ▼

TFTP Server IP	192.168.0.100
Firmware File Name	JetNet5010G-v1.2.bin

Note: When firmware upgrade is finished, the switch will restart automatically.

**Upgrade**

Type the IP address of TFTP Server and Firmware File Name. Then click on **Upgrade** to start the process.

After finishing transmitting the firmware, the system will copy the firmware file and replace the firmware in the flash. The CLI show ..... until the process is finished.

#### 4.2.8 Factory Default

In this section, you can reset all the configurations of the switch to default setting. Click on **Reset** the system will then reset all configurations to default setting. The system will show you popup message window after finishing this command. Default setting will work after rebooting the switch.

Figure- 4.2.8.1 The main screen of the Reset to Default



Figure 4.2.8.2 Popup alert screen to confirm the command. Click on **Yes** to start it.

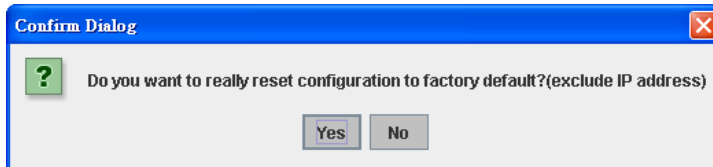
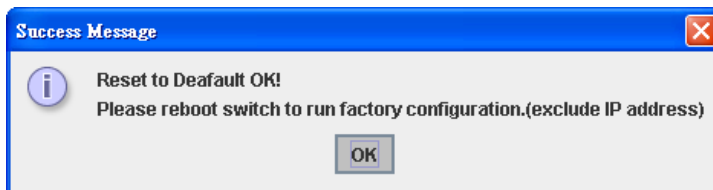

Figure 4.2.8.3 Popup message screen to show you that have done the command. Click on **OK** to close the screen. Then please go to **Reboot** page to reboot the switch.



Click on **OK**. The system will then auto reboot the device.

Note: If you already configured the IP of your device to other IP address, when you use this command by CLI and Web UI, our software will not reset the IP address to default IP. The system will remain the IP address so that you can still connect the switch via the network.

#### 4.2.9 System Reboot

System Reboot allows you to reboot the device. Some of the feature changes require you to reboot the system. Click on **Reboot** to reboot your device.

**Note:** Remember to click on **Save** button to save your settings. Otherwise, the settings you made will be gone when the switch is powered off.

Figure 4.2.9.1 Main screen for Rebooting



Figure 4.2.9.2 Pop-up alert screen to request confirmation. Click on “Yes”, then the switch will be rebooted immediately.

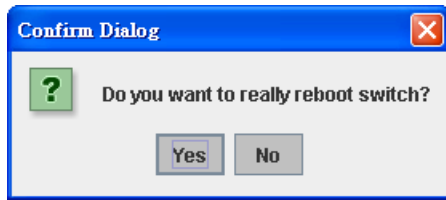
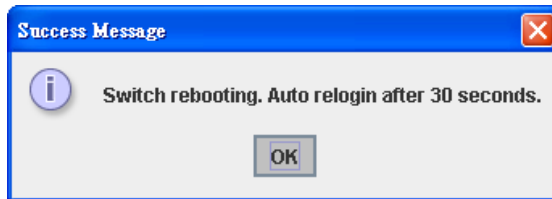

Figure 4.2.9.3 Pop-up message screen appears when rebooting the switch..



#### 4.2.10 CLI Commands for Basic Setting

Feature	Command Line
<b>Switch Setting</b>	
System Name	Switch(config)# hostname WORD Network name of this system Switch(config)# hostname JN5010G SWITCH(config)#
System Location	SWITCH(config)# snmp-server location Taipei
System Contact	SWITCH(config)# snmp-server contact korecare@korenix.com
Display	SWITCH# show snmp-server name SWITCH  SWITCH# show snmp-server location Taipei  SWITCH# show snmp-server contact <a href="mailto:korecare@korenix.com">korecare@korenix.com</a>  SWITCH> show version 0.31-20061218  Switch# show hardware mac MAC Address : 00:12:77:FF:01:B0
<b>Admin Password</b>	
User Name and Password	SWITCH(config)# administrator NAME Administrator account name SWITCH(config)# administrator orwell

	PASSWORD Administrator account password SWITCH(config)# administrator orwell orwell Change administrator account orwell and password orwell success.
Display	SWITCH# show administrator Administrator account information name: orwell password: orwell
<b>IP Configuration</b>	
IP Address/Mask (192.168.10.8, 255.255.255.0	SWITCH(config)# int vlan 1 SWITCH(config-if)# ip ; IPv4 configuration address dhcp SWITCH(config-if)# ip address 192.168.10.8/24 SWITCH(config-if)# ip dhcp client SWITCH(config-if)# ip dhcp client renew Switch(config-if)# ipv6 address ; IPv6 configuration X::X:X/M IPv6 address (e.g. 3ffe:506::1/48) Switch(config-if)# ipv6 address 3ffe:506::1/48
Gateway	SWITCH(config)# ip route 0.0.0.0/0 192.168.10.254/24
Remove Gateway	SWITCH(config)# no ip route 0.0.0.0/0 192.168.10.254/24
Display	SWITCH# show running-config ..... ! interface vlan1 ip address 192.168.10.8/24 no shutdown ! ip route 0.0.0.0/0 192.168.10.254/24 !
<b>Time Setting</b>	
NTP Server	SWITCH(config)# ntp peer enable disable primary secondary SWITCH(config)# ntp peer primary IPADDR SWITCH(config)# ntp peer primary 192.168.10.120
Time Zone	SWITCH(config)# clock timezone 26 Sun Jan 1 04:13:24 2006 (GMT) Greenwich Mean Time: Dublin, Edinburgh, Lisbon, London  <b>Note:</b> By typing clock timezone ?, you can see the timezone list. Then choose the number of the timezone you want to select.
Daylight Saving	Switch(config)# clock summer-time 4 0 2 12:00 4 0 3 12:00 Clock summer-time <start week of month > <start weekday> <start month> <start Hour:Min> <end week of month> <end weekday> <end month> <end Hour:Min>
Display	SWITCH# sh ntp associations Network time protocol Status : Disabled Primary peer : N/A Secondary peer : N/A

	<pre>SWITCH# show clock Sun Jan  1 04:14:19 2006 (GMT) Greenwich Mean Time: Dublin, Edinburgh, Lisbon, London  SWITCH# show clock timezone clock timezone (26) (GMT) Greenwich Mean Time: Dublin, Edinburgh, Lisbon, London</pre>
<b>DHCP Server</b>	
DHCP Server configuration	<pre>Enable DHCP Server on JetNet Switch Switch# Switch# configure terminal Switch(config)# router dhcp Switch(config-dhcp)# service dhcp  Configure DHCP network address pool Switch(config-dhcp)#network 50.50.50.0/4 -( network/mask) Switch(config-dhcp)#default-router 50.50.50.1</pre>
Lease time configure	<pre>Switch(config-dhcp)#lease 300 (300 sec)</pre>
DHCP Relay Agent	<pre>Enable DHCP Relay Agent Switch# Switch# configure terminal Switch(config)# router dhcp Switch(config-dhcp)# service dhcp Switch(config-dhcp)# ip dhcp relay information option  Enable DHCP Relay policy Switch(config-dhcp)# ip dhcp relay information policy <u>replace</u> drop      Relay Policy keep      Drop/Keep/Replace option82 field replace</pre>
Show DHCP server information	<pre>Switch# show ip dhcp server statistics Switch# show ip dhcp server statistics DHCP Server ON Address Pool 1   network:192.168.17.0/24   default-router:192.168.17.254   lease time:300 Excluded Address List   IP Address   -----   (list excluded address) Manual Binding List   IP Address      MAC Address   -----  -----   (list IP &amp; MAC binding entry) Leased Address List   IP Address      MAC Address      Leased Time Remains   -----  -----  -----   (list leased Time remain information for each entry)</pre>
<b>Backup and Restore</b>	
Backup Startup Configuration file	<pre>Switch# copy startup-config tftp: 192.168.10.33/default.conf Writing Configuration [OK]</pre> <p><b>Note 1:</b> To backup the latest startup configuration file, you should save current settings to flash first. You can refer to 4.12</p>

	<p>to see how to save settings to the flash.  Note 2: 192.168.10.33 is the TFTP server's IP and default.conf is name of the configuration file. Your environment may use different IP addresses or different file name. Please type target TFTP server IP or file name in this command.</p>
Restore Configuration	Switch# copy tftp: 192.168.10.33/default.conf startup-config
Show Startup Configuration	Switch# show startup-config
Show Running Configuration	Switch# show running-config
<b>Firmware Upgrade</b>	
Firmware Upgrade	Switch# archive download-sw /overwrite tftp 192.168.10.33 JN5010G.bin Firmware upgrading, don't turn off the switch! Tftping file JN5010G.bin Firmware upgrading ..... ..... ..... Firmware upgrade success!! Rebooting.....
<b>Factory Default</b>	
Factory Default	Switch# reload default-config file Reload OK! Switch# reboot
<b>System Reboot</b>	
Reboot	Switch# reboot

## 4.3 Port Configuration

Port Configuration group enables you to enable/disable port state, or configure port auto-negotiation, speed, and duplex, flow control, rate limit control and port aggregation settings. It also allows you to view port status and aggregation information.

Following commands are included in this group:

### 4.3.1 Port Control

### 4.3.2 Port Status

### 4.3.3 Rate Control

### 4.3.4 Port Trunking

### 4.3.5 Command Lines for Port Configuration

### 4.3.1 Port Control

Port Control commands allow you to enable/disable port state, or configure the port auto-negotiation, speed, duplex and flow control.

Port	State	Speed/Duplex	Flow Control
1	Enable	AutoNegotiation	Disable
2	Enable	AutoNegotiation	Disable
3	Enable	AutoNegotiation	Disable
4	Enable	AutoNegotiation	Disable
5	Enable	AutoNegotiation	Disable
6	Enable	AutoNegotiation	Disable
7	Enable	AutoNegotiation	Disable
8	Enable	AutoNegotiation	Disable
9	Enable	AutoNegotiation	Disable
10	Enable	AutoNegotiation	Disable

Apply

Select the port you want to configure and make changes to the port.

In **State** column, you can enable or disable the state of this port. Once you select and apply to disable the port, the port will stop to link to the other end and stop to forward any traffic. The default setting is Enable which means all the ports are workable when you receive the device.

In **Speed/Duplex** column, you can configure port speed and duplex mode of this port. Below are the selections you can choose:

Fast Ethernet Port 1~7 (fa1~fa7) : AutoNegotiation, 10M Full Duplex(10 Full), 10M Half Duplex(10 Half), 100M Full Duplex(100 Full) and 100M Half Duplex(100 Half).

Gigabit Ethernet Port 8~10: (gi8~gi10) : AutoNegotiation, 10M Full Duplex(10 Full), 10M Half Duplex(10 Half), 100M Full Duplex(100 Full), 100M Half Duplex(100 Half), 1000M Full Duplex(1000 Full), 1000M Half Duplex(1000 Half).

The default mode is Auto Negotiation mode.

In **Flow Control** column, “Symmetric” means that you need to activate the flow control function of the remote network device in order to let the flow control of that corresponding port on the switch to work. “Disable” means that you don’t need to activate the flow control function of the remote network device, as the flow control of that corresponding port on the switch will work anyway.

Once you finish configuring the settings, click on **Apply** to save the configuration.

**Technical Tips:** *If both ends are not at the same speed, they can’t link with each other. If both ends are not in the same duplex mode, they will be connected by half mode.*

### 4.3.2 Port Status

Port Status shows you current port status.

In the firmware version 2.2, it supports Small Form Factory (SFP) fiber transceiver with Digital Diagnostic Monitoring (DDM) function that provides real time information of SFP transceiver and allows user to diagnostic the optical fiber signal received and launched.

The information of SFP DDM will listing on another table.

#### Port Status

Port	Type	Link	State	Speed/Duplex	Flow Control	SFP Vendor	Wavelength	Distance
1	100BASE-TX	Up	Enable	100 Full	Disable	--	--	--
2	100BASE	Down	Enable	--	Disable	--	--	--
3	100BASE	Down	Enable	--	Disable	--	--	--
4	100BASE	Down	Enable	--	Disable	--	--	--
5	100BASE	Down	Enable	--	Disable	--	--	--
6	100BASE	Down	Enable	--	Disable	--	--	--
7	100BASE	Down	Enable	--	Disable	--	--	--
8	1000BASE-LX	Up	Enable	1000 Full	Disable	Korenix	1310nm	30km
9	1000BASE-S...	Up	Enable	1000 Full	Disable	Korenix	850nm	550m
10	1000BASE-S...	Up	Enable	1000 Full	Disable	Korenix	850nm	550m

#### SFP DDM

Port	Remove	Temperature (°C)		Tx Power (dBm)		Rx Power (dBm)	
		Current	Range	Current	Range	Current	Range
8	Eject	--	--	--	--	--	--
9	Eject	58.00	0.00 ~ 80.00	-6.0	-9.0 ~ -4.0	-2.0	-30.0 ~ -4.0
10	Eject	62.00	0.00 ~ 80.00	-6.0	-9.0 ~ -4.0	-2.0	-30.0 ~ -4.0

Reload
Eject All

The description of the columns is as below:

**Port:** Port interface number.

**Type:** 100TX -> Fast Ethernet port. 1000TX -> Gigabit Ethernet port.

**Link:** Link status. Up -> Link UP. Down -> Link Down.



**State:** Enable -> State is enabled. Disable -> The port is disable/shutdown.

**Speed/Duplex:** Current working status of the port.

**Flow Control:** The state of the flow control.

**SFP Vendor:** Vendor name of the SFP transceiver you plugged.

**Wavelength:** The wave length of the SFP transceiver you plugged.

**Distance:** The distance of the SFP transceiver you plugged.

**Reload:** reload the all port information.

**Scan all:** scan the SFP transceiver and display.

**Eject:** Eject the SFP transceiver that you have selected. You can eject one port or eject all by click the icon "Eject All".

**Temperature:** The temperature specific and current detected of DDM SFP transceiver.

**Tx Power (dBm):** The specification and current transmit power of DDM SFP transceiver.

**Rx Power (dBm):** The specification and current received power of DDM SFP transceiver.

**Note:** 1. Most of the SFP transceivers provide vendor information which allows your switch to read it. The UI can display vendor name, wave length and distance of all Korenix SFP transceiver family. If you see Unknown info, it may mean that the vendor doesn't provide their information or that the information of their transceiver can't be read.

2. if the plugged DDM SFP transceiver is not certified by Korenix, the DDM function will not be supported. But the communication will not be disabled.

### 4.3.3 Rate Control

Rate limiting is a form of flow control used to enforce a strict bandwidth limit at a port. You can program separate transmit (Egress Rule) and receive (Ingress Rule) rate limits at each port, and even apply the limit to certain packet types as described below.

**Rate Control**

**Limit Packet Type and Rate**

Port	Ingress Rule		Egress Rule	
	Packet Type	Rate(Mbps)	Packet Type	Rate(Mbps)
1	Broadcast Only	8	All	0
2	Broadcast Only	8	All	0
3	Broadcast Only	8	All	0
4	Broadcast Only	8	All	0
5	Broadcast Only	8	All	0
6	Broadcast Only	8	All	0
7	Broadcast Only	8	All	0
8	Broadcast Only	8	All	0
9	Broadcast Only	8	All	0
10	Broadcast Only	8	All	0

Apply

**Packet type:** You can select the packet type that you want to filter. The packet types of the Ingress Rule listed here include **Broadcast Only / Broadcast and multicast / Broadcast, Multicast and Unknown Unicast** or **All**. The packet types of the Egress Rule (outgoing) only support **all** packet types.

**Rate:** This column allows you to manually assign the limit rate of the port. Valid values are from 1Mbps-100Mbps for fast Ethernet ports and gigabit Ethernet ports. The step of the rate is 1 Mbps. Default value of Ingress Rule is “8” Mbps; default value of Egress Rule is 0 Mbps. 0 stands for disabling the rate control for the port.

Click on **Apply** to apply the configuration.

#### 4.3.4 Port Trunking

Port Trunking configuration allows you to group multiple Ethernet ports in parallel to increase link bandwidth. The aggregated ports can be viewed as one physical port so that the bandwidth is higher than merely one single Ethernet port. The member ports of the same trunk group can balance the loading and backup for each other. Port Trunking feature is usually used when you need higher bandwidth for backbone network. This is an inexpensive way for you to transfer more data.

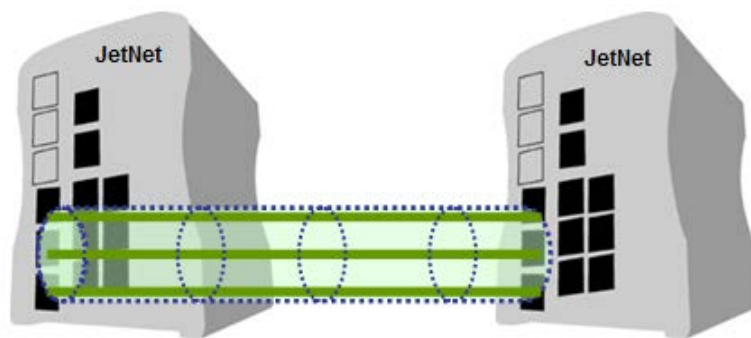

There are some different descriptions for the port trunking. Different manufacturers may use different descriptions for their products, like Link Aggregation Group (LAG), Link Aggregation Control Protocol, Ethernet Trunk, Ether Channel...etc. Most of the implementations now conform to IEEE standard, 802.3ad.

The aggregated ports can interconnect to the other switch which also supports Port Trunking. Korenix Supports 2 types of port trunking. One is Static Trunk, the other is 802.3ad. When the other end uses 802.3ad LACP, you **should** assign 802.3ad LACP to the trunk. When the other end uses non-802.3ad, you can then use Static Trunk.

There are 2 configuration pages, Aggregation Setting and Aggregation Status.

##### Aggregation Setting

**Trunk Size:** The switch can support up to 5 trunk groups. Each trunk group can support up to 8 member ports. Since the member ports should use same speed/duplex, max groups for 100M ports would be 7, and 3 for gigabit ports.

**Group ID:** Group ID is the ID for the port trunking group. Ports with same group ID are in the same group.

**Type: Static and 802.3ad LACP.** Each Trunk Group can only support Static or 802.3ad LACP. Choose the type you need here.

**Extended setting in CLI: (Added in**

#### Port Trunk - Aggregation Setting

Port	Group ID	Type
1	Trunk 1	Static
2	Trunk 1	Static
3	Trunk 2	802.3ad LACP
4	Trunk 2	802.3ad LACP
5	None	Static
6	None	Static
7	None	Static
8	None	Static
9	None	Static
10	None	Static

Note: The port parameters of the trunk members should be the same.

## firmware V2.4)

**Port Priority:** The command allows you to change the port priority setting of the specific port. LACP port priority is configured on each port using LACP. The port priority can be configured through the CLI. The higher the number, the lower the priority. The default value is 32768.

**LACP Timeout:** The LACPDU is generated and continue transmit within the LACP group. The interval time of the LACPDU Long timeout is 30 sec, this is default setting. The LACPDP Short timeout is 1 sec, the command to change from Long to Short is only applied to the CLI, the web GUI doesn't support this. Once the LACP port doesn't receive the LACPDP 3 times, that means the port may leave the group without earlier inform or does not detect by the switch, then the port will be removed from the group.

This command can be used when connect the switch by 2-port LACP through not-direct connected or shared media, like the Wireless AP or Hub. The end of the switch may not directly detect the failure, the LACP Short Timeout can detect the LACP group failure earlier within 3 seconds.

### Aggregation Status

This page shows the status of port aggregation. Once the aggregation ports are negotiated well, you will see following status.

Group ID	Type	Group Member		
		Aggregated	Individual	Link Down
Trunk 1	LACP		7	5,6
Trunk 2	LACP	8,9,10		
Trunk 3				
Trunk 4				
Trunk 5				

**Group ID:** Display Trunk 1 to Trunk 5 set up in Aggregation Setting.

**Type:** Static or LACP set up in Aggregation Setting.

**Aggregated:** When LACP links well, you can see the member ports in Aggregated column.

**Individual:** When LACP is enabled, member ports of LACP group which are not connected to correct LACP member ports will be displayed in the Individual column.

**Link Down:** When LACP is enabled, member ports of LACP group which are not linked up will be displayed in the Link Down column.

### 4.3.5 Command Lines for Port Configuration

Feature	Command Line
<b>Port Control</b>	
Port Control – State	Switch(config-if)# shutdown -> Disable port state Port1 Link Change to DOWN interface fastethernet1 is shutdown now.

	<p>Switch(config-if)# no shutdown -&gt; Enable port state  Port1 Link Change to DOWN  Port1 Link Change to UP  interface fastethernet1 is up now.  Switch(config-if)# Port1 Link Change to UP</p> <p>Switch(config)# sfp  ddm Digital diagnostic and monitoring  Switch(config)# sfp ddm  Eject Reject DDM SFP  Switch(config)# sfp ddm eject → eject SFP DDM transceiver  all All DDM interface  Example: Switch(config)# sfp ddm eject all  DDM SFP on Port 9 normally ejected.  DDM SFP on Port 9 normally ejected.  All DDM SFP normally ejected.</p> <p>Switch(config)# interface gigabitethernet10 → eject port 10  SFP DDM transceiver.  Switch(config-if)# sfp ddm eject  DDM SFP on Port 10 normally ejected.</p>
Port Control – Auto Negotiation	<p>Switch(config)# interface fa1  Switch(config-if)# auto-negotiation  Auto-negotiation of port 1 is enabled!</p>
Port Control – Force Speed/Duplex	<p>Switch(config-if)# speed 100  Port1 Link Change to DOWN  set the speed mode ok!  Switch(config-if)# Port1 Link Change to UP</p> <p>Switch(config-if)# duplex full  Port1 Link Change to DOWN  set the duplex mode ok!  Switch(config-if)# Port1 Link Change to UP</p>
Port Control – Flow Control	<p>Switch(config-if)# flowcontrol on  Flowcontrol on for port 1 set ok!</p> <p>Switch(config-if)# flowcontrol off  Flowcontrol off for port 1 set ok!</p>
<b>Port Status</b>	
Port Status	<p>Switch# show interface fa1  Interface fastethernet1  Administrative Status : Enable  Operating Status : Connected  Duplex : Full  Speed : 100  Flow Control :off  Default Port VLAN ID: 1  Ingress Filtering : Disabled  Acceptable Frame Type : All  Port Security : Disabled  Auto Negotiation : Disable  Loopback Mode : None  STP Status: forwarding</p>

	<p>Default CoS Value for untagged packets is 0.  Mdix mode is Disable.  Medium mode is Copper.</p> <p>Switch# show sfp ddm →show SFP DDM information  Port 8  Temperature:N/A  Tx power:N/A  Rx power:N/A  Port 9  Temperature:64.00 C &lt;range :0.0-80.00&gt;  Tx power:-6.0 dBm &lt;range : -9.0 - -4.0&gt;  Rx power:-30.0 dBm &lt;range: -30.0 - -4.0&gt;  Port 10  Temperature:67.00 C &lt;range :0.0-80.00&gt;  Tx power:-6.0 dBm &lt;range : -9.0 - -4.0&gt;  Rx power:-2.0 dBm &lt;range: -30.0 - -4.0&gt;</p> <p><i>Note: Administrative Status -&gt; Port state of the port. Operating status -&gt; Current status of the port. Duplex -&gt; Duplex mode of the port. Speed -&gt; Speed mode of the port. Flow control -&gt; Flow Control status of the port.</i></p>
<b>Rate Control</b>	
Rate Control – Ingress or Egress	<p>Switch(config-if)# rate-limit  egress    Outgoing packets  ingress   Incoming packets</p> <p><b>Note: To enable rate control, you should select the Ingress or Egress rule first; then assign the packet type and bandwidth.</b></p>
Rate Control – Filter Packet Type	<p>Switch(config-if)# rate-limit ingress mode  all            Limit all frames  broadcast     Limit Broadcast frames  flooded-unicast Limit Broadcast, Multicast and flooded unicast frames  multicast     Limit Broadcast and Multicast frames</p> <p>Switch(config-if)# rate-limit ingress mode broadcast  Set the ingress limit mode broadcast ok.</p>
Rate Control - Bandwidth	<p>Switch(config-if)# rate-limit ingress bandwidth  &lt;0-100&gt;    Limit in magabits per second (0 is no limit)</p> <p>Switch(config-if)# rate-limit ingress bandwidth 8  Set the ingress rate limit 8Mbps for Port 1.</p>
<b>Port Trunking</b>	
LACP	<p>Switch(config)# lacp group 1 gi8-10  Group 1 based on LACP(802.3ad) is enabled!</p> <p><i>Note: The interface list is fa 1,fa3-5,gi8-10</i>  Note: different speed port can't be aggregated together.</p>
LACP – Port Setting  Long/Short Timeout (New Feature in V2.4)	<p>SWITCH(config-if)# lacp  port-priority LACP priority for physical interfaces  timeout        assigns an administrative LACP timeout</p> <p>SWITCH(config-if)# lacp port-priority  &lt;1-65535&gt;    Valid port priority range 1 - 65535 (default is 32768)</p> <p>SWITCH(config-if)# lacp timeout  long    specifies a long timeout value (default)  short   specifies a short timeout value</p>

	<pre>SWITCH(config-if)# lacp timeout short Set lacp port timeout ok.</pre>
Static Trunk	<pre>Switch(config)# trunk group 2 fa6-7 Trunk group 2 enable ok!  Failure to configure due to the group ID is existed. SWITCH(config)# trunk group 1 fa11-12 Can't set trunk group 1 enable! The group 1 is a lacp enabled group! SWITCH(config)# trunk group 2 fa11-12 Can't set trunk group 2 enable! The group 2 is a static aggregation group.</pre>
Display - LACP	<pre>etNet 5010G# show lacp internal LACP group 1 internal information:       LACP Port  Admin   Oper   Port Port Priority  Key     Key     State -----       8         1       8       8    0x45       9         1       9       9    0x45      10         1      10      10    0x45  LACP group 2 is inactive LACP group 3 is inactive LACP group 4 is inactive</pre>
Display - Trunk	<pre>Switch# show trunk group 1 FLAGS:      I -&gt; Individual          P -&gt; In channel             D -&gt; Port Down  Trunk Group GroupID  Protocol  Ports -----+-----       1      LACP    8(D) 9(D) 10(D) Switch# show trunk group 2 FLAGS:      I -&gt; Individual          P -&gt; In channel             D -&gt; Port Down  Trunk Group GroupID  Protocol  Ports -----+-----       2      Static  6(D) 7(P) Switch#</pre>

## 4.4 Network Redundancy

It is critical for industrial applications that network remains non-stop. Korenix develops multiple kinds of standard (STP, RSTP and MSTP) and Korenix patterned redundancy protocol, Multiple Super Ring to remain the network redundancy can be protected well by Korenix switch.

The Switch supports standard STP/RSTP and Multiple Super Ring (MSR). The MSR includes Rapid Super Ring, Rapid Dual Homing, TrunkRing, MultiRing and backward compatible with Legacy Super Ring Client modes.

Additionally, the Multiple Spanning Tree Protocol (MSTP) start supports from version 2.4 firmware. This protocol is a direct extension of RSTP. It can provide an independent spanning tree for different VLANs. It simplifies network management, provides for even faster convergence than RSTP by limiting the size of each region, and prevents VLAN members from being segmented from the rest of the group (as sometimes occurs with IEEE 802.1D STP).

Multiple Super Ring (MSR) technology is *Korenix's* 3<sup>rd</sup> generation Ring redundancy technology. This is patented and protected by *Korenix* and is used in countries all over the world. MSR ranks the fastest restore and failover time in the world, 0 ms for restore and about 5 milliseconds for failover for copper.

The single Korenix switch can aggregate multiple Rings within one switch. All the ports can be configured as the ring port of a ring, each ring has its own Ring ID and the Ring ID will be added to the watchdog packet to monitor the ring status. This is Korenix Patterned MultiRing Technology.

The Ring ports can be LACP/Port Trunking ports, after aggregated ports to a group, the group of ports can act as the Ring port of the Ring. This is Korenix Patterned TrunkRing Technology.

Advanced Rapid Dual Homing(RDH) technology also facilitates *the Switch* to connect with a core managed switch easily and conveniently. With RDH technology, you can also couple several Rapid Super Rings or RSTP cloud together, which is also known as Auto Ring Coupling. After firmware v2.8, the RDH ID extends to 256.

Following commands are included in this group:

4.4.1 STP Configuration

4.4.2 STP Port Configuration

4.4.3 STP Information

4.4.4 MSTP Configuration

4.4.5 MSTP Port Configuration

4.4.6 MSTP information

4.4.7 Multiple Super Ring

4.4.8 Multiple Super Ring Information

4.4.9 Loop Protection

4.4.10 ERPS

4.4.11 Command Lines for Network Redundancy

The new Network Redundancy Configuration/Information tree of Web UI is applied to the **firmware V2.8**.

The **STP Configuraiton, STP Port Configuration and STP Information** pages are available while select the **STP and RSTP** mode.

The **MSTP Configuraiton, MSTP Port Configuration and MSTP Information** pages are available while select the **MSTP** mode.

The **Multiple Super Ring and Multiple Super Ring Information** are available while select the **MSR** mode.

Since the **firmware version 2.6**, the Switch supports port based **STP Enable/disable** function, and also provides **loop protect** for each port to achieve loop eliminate when applies STP and MSR functions.

#### 4.4.1 STP Configuration

This page allows select the STP mode and configuring the global STP/RSTP Bridge Configuraiton.

The STP mode includes the **STP, RSTP, MSTP** and **Disable**. Please select the STP mode for your system first. The default mode is RSTP enabled.

Afte select the STP or RSTP mode, continue to configure the gloable Bridge parameters for STP and RSTP.

After select the MSTP mode, please go to MSTP Configuration page.

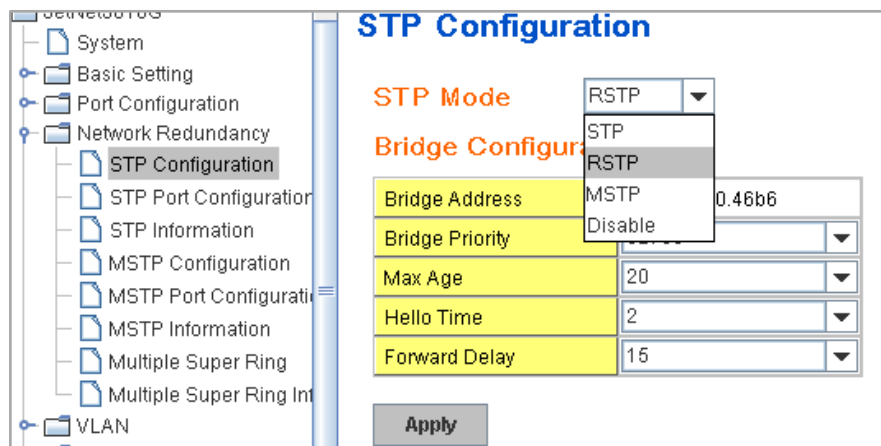

#### RSTP (Refer to the 4.4.1 of previous version manual.)

RSTP is the abbreviation of Rapid Spanning Tree Protocol. If a switch has more than one path to a destination, it will lead to message loops that can generate broadcast storms and quickly bog down a network. The spanning tree was created to combat the negative effects of message loops in switched networks. A spanning tree uses a spanning tree algorithm (STA) to automatically sense whether a switch has more than one way to communicate with a node. It will then select the best path (primary), and block the other path(s). It will also keep track of the blocked path(s) in case the primary path fails. Spanning Tree Protocol (STP) introduced a standard method to accomplish this. It is specified in IEEE 802.1D-1998. Later, Rapid Spanning Tree Protocol (RSTP) was adopted and represents the evolution of STP, providing much faster spanning tree convergence after a topology change. This is specified in IEEE 802.1w. In 2004, 802.1w is included into 802.1D-2004 version. This switch supports both RSTP and STP (all switches that support RSTP are also



backward compatible with switches that support only STP).

### **Bridge Configuration**

**Bridge Address:** This shows the switch's MAC address.

**Priority (0-61440):** RSTP uses bridge ID to determine the root bridge, the bridge with the highest bridge ID becomes the root bridge. The bridge ID is composed of bridge priority and bridge MAC address. So that the bridge with the highest priority becomes the highest bridge ID. If all the bridge ID has the same priority, the bridge with the lowest MAC address will then become the root bridge.

Note: The bridge priority value must be in multiples of 4096. A device with a lower number has a higher bridge priority. Ex: 4096 is higher than 32768.

Note: The Web GUI allows user select the priority number directly. This is the convenient of the GUI design. When you configure the value through the CLI or SNMP, you may need to type the value directly. Please follow the  $n \times 4096$  rule for the Bridge Priority.

**Max Age (6-40):** Enter a value from 6 to 40 seconds here. This value represents the time that a bridge will wait without receiving Spanning Tree Protocol configuration messages before attempting to reconfigure.

If JetNet is not the root bridge, and if it has not received a hello message from the root bridge in an amount of time equal to Max Age, then JetNet will reconfigure itself as a root bridge. Once two or more devices on the network are recognized as a root bridge, the devices will renegotiate to set up a new spanning tree topology.

**Hello Time (1-10):** Enter a value from 1 to 10 seconds here. This is a periodic timer that drives the switch to send out BPDU (Bridge Protocol Data Unit) packet to check current STP status.

The root bridge of the spanning tree topology periodically sends out a "hello" message to other devices on the network to check if the topology is "healthy". The "hello time" is the amount of time the root has waited during sending hello messages.

**Forward Delay Time (4-30):** Enter a value between 4 and 30 seconds. This value is the time that a port waits before changing from Spanning Tree Protocol learning and listening states to forwarding state.

This is the amount of time JetNet will wait before checking to see if it should be changed to a different state.

Once you have completed your configuration, click on **Apply** to apply your settings.

**Note:** You must observe the following rule to configure Hello Time, Forwarding Delay, and Max Age parameters.

**$2 \times (\text{Forward Delay Time} - 1 \text{ sec}) \geq \text{Max Age Time} \geq 2 \times (\text{Hello Time value} + 1 \text{ sec})$**

## 4.4.2 STP Port Configuration

Port	STP State	Path Cost	Priority	Link Type	Edge Port
1	Enable	200000	128	Auto	Enable
2	Enable	200000	128	Auto	Enable
3	Enable	200000	128	Auto	Enable
4	Enable	200000	128	Auto	Enable
5	Enable	200000	128	Auto	Enable
6	Enable	200000	128	Auto	Enable
7	Enable	200000	128	Auto	Enable
8	Enable	20000	128	Auto	Enable
9	Enable	20000	128	Auto	Enable
10	Enable	20000	128	Auto	Enable

Apply

This page allows you to configure the port parameter after enabled STP or RSTP.

### Port Configuration

Select the port you want to configure and you will be able to view current settings and status of the port.

**STP State:** Enable /Disable the STP function by port configure. (Available with firmware v2.6)

**Path Cost:** Enter a number between 1 and 200,000,000. This value represents the “cost” of the path to the other bridge from the transmitting bridge at the specified port.

**Priority:** Enter a value between 0 and 240, using multiples of 16. This is the value that decides which port should be blocked by priority in a LAN.

**Link Type:** There are 3 types for you select. **Auto**, **P2P** and **Share**.

Some of the rapid state transitions that are possible within RSTP depend upon whether the port of concern can only be connected to another bridge (i.e. it is served by a point-to-point LAN segment), or if it can be connected to two or more bridges (i.e. it is served by a shared-medium LAN segment). This function allows link status of the link to be manipulated administratively. “**Auto**” means to auto select P2P or Share mode. “**P2P**” means P2P is enabled, the 2 ends work in Full duplex mode. While “**Share**” is enabled, it means P2P is disabled, the 2 ends may connect through a share media and work in Half duplex mode.

**Edge:** A port directly connected to the end stations cannot create a bridging loop in the network. To configure this port as an edge port, set the port to the **Enable** state. When the non-bridge device connects an admin edge port, this port will be in blocking state and turn to forwarding state in 4 seconds.

Once you finish your configuration, click on **Apply** to save your settings.

### 4.4.3 STP Info

This page allows you to see the information of the root switch and port status.

#### STP Information

##### Root Information

Root Address	0012.77ff.0000
Root Priority	32768
Root Port	N/A
Root Path Cost	0
Max Age	20 second(s)
Hello Time	2 second(s)
Forward Delay	15 second(s)

##### Port Information

Port	Role	Port State	Path Cost	Port Priority	Link Type	Edge Port	Aggregated(ID/Type)
1	--	--	200000	128	P2P	Edge	/
2	--	--	200000	128	P2P	Edge	/
3	Designated	Forwarding	200000	128	P2P	Edge	/
4	--	--	200000	128	P2P	Edge	/
5	--	--	200000	128	P2P	Edge	/
6	--	--	200000	128	P2P	Edge	/
7	--	--	200000	128	P2P	Edge	/
8	--	--	20000	128	P2P	Edge	/
9	--	--	20000	128	P2P	Edge	/
10	--	--	20000	128	P2P	Edge	/

**Root Information:** You can see root Bridge ID, Root Priority, Root Port, Root Path Cost and the Max Age, Hello Time and Forward Delay of BPDU sent from the root switch.

**Port Information:** You can see port Role, Port State, Path Cost, Port Priority, Oper P2P mode, Oper edge port mode and Aggregated (ID/Type).

### 4.4.4 MSTP (Multiple Spanning Tree Protocol) Configuration

MSTP is the abbreviation of Multiple Spanning Tree Protocol. This protocol is a direct extension of RSTP. It can provide an independent spanning tree for different VLANs. It simplifies network management, provides for even faster convergence than RSTP by limiting the size of each region, and prevents VLAN members from being segmented from the rest of the group (as sometimes occurs with IEEE 802.1D STP).

While using MSTP, there are some new concepts of network architecture. A switch may belong to different groups, act as root or designate switch, generate BPDU for the network to maintain the forwarding table of the spanning tree. With MSTP can also provide multiple forwarding paths and enable load balancing. Understand the architecture allows you to maintain the correct spanning tree and operate effectively.

One VLAN can be mapped to a Multiple Spanning Tree Instance (MSTI). The maximum Instance Switch supports is 16, range from 0-15. The MSTP builds a separate Multiple Spanning Tree (MST) for each instance to maintain connectivity among each of the assigned VLAN groups. An Internal Spanning Tree (IST) is used to connect all the MSTP switches within an MST region. An MST Region may contain multiple MSTP Instances.

The figure shows there are 2 VLANs/MSTP Instances and each instance has its Root and forwarding paths.

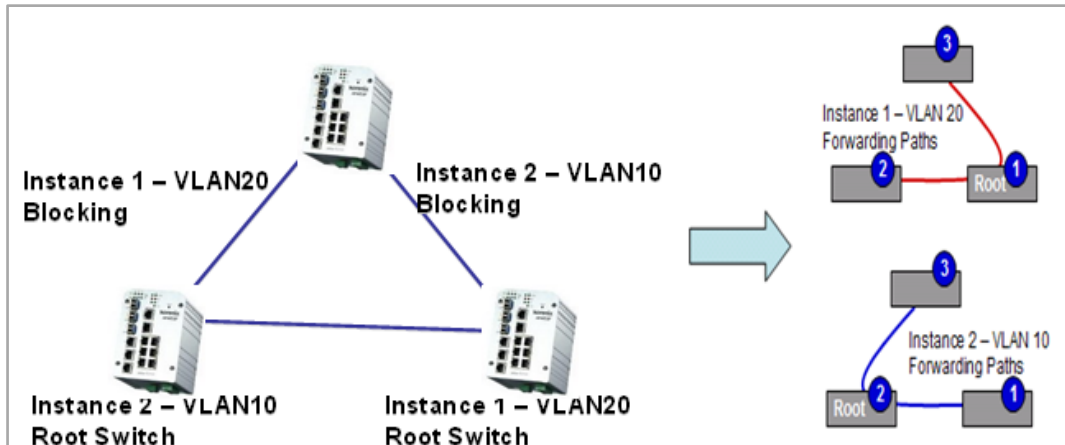

A Common Spanning Tree (CST) interconnects all adjacent MST regions and acts as a virtual bridge node for communications with STP or RSTP nodes in the global network. MSTP connects all bridges and LAN segments with a single Common and Internal Spanning Tree (CIST). The CIST is formed as a result of the running spanning tree algorithm between switches that support the STP, RSTP, MSTP protocols.

The figure shows the CST large network. In this network, a Region may have different instances and its own forwarding path and table, however, it acts as a single Bridge of CST.

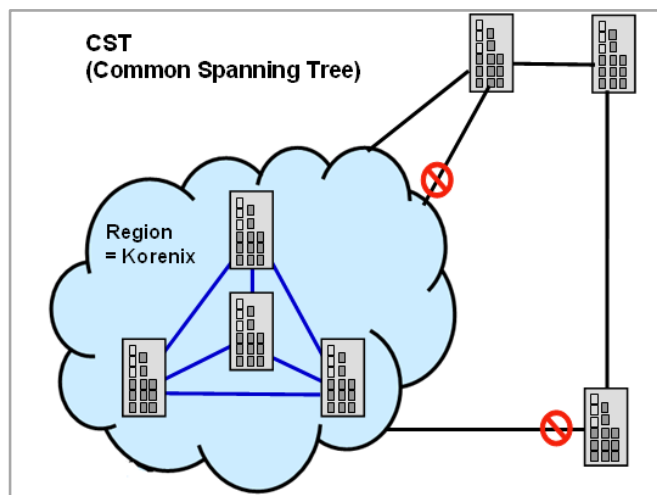

To configure the MSTP setting, the STP Mode of the STP Configuration page should be changed to MSTP mode first.

### STP Configuration

STP Mode

#### Bridge Configuration

Bridge Address	0012.7780.46b6
Bridge Priority	32768
Max Age	20
Hello Time	2
Forward Delay	15

After enabled MSTP mode, then you can go to the MSTP Configuration pages.

### MSTP Region Configuration

This page allows configure the Region Name and its Revision, mapping the VLAN to Instance and check current MST Instance configuration. The network can be divided virtually to different Regions. The switches within the Region should have the same Region and Revision level.

**Region Name:** The name for the Region. Maximum length: 32 characters.

**Revision:** The revision for the Region. Range: 0-65535; Default: 0)

Once you finish your configuration, click on **Apply** to apply your settings.

### New MST Instance

This page allows mapping the VLAN to Instance and assign priority to the instance. Before mapping VLAN to Instance, you should create VLAN and assign the member ports first. Please refer to the VLAN setting page.

**Instance ID:** Select the Instance ID, the available number is 1-15.

**VLAN Group:** Type the VLAN ID you want mapping to the instance.

**Instance Priority:** Assign the priority to the instance.

**After** finish your configuration, click on **Add** to apply your settings.

### MSTP Configuration

#### MST Region Configuration

Region Name	Korenix
Revision	0

#### New MST Instance

Instance ID	1
VLAN Group	
Instance Priority	32768

#### Current MST Instance Configuration

Instance ID	VLAN Group	Instance Priority
1	2	32768
2	3	32768

### Current MST Instance Configuration

This page allows you to see the current MST Instance Configuration you added. Click on “**Apply**” to apply the setting. You can “**Remove**” the instance or “**Reload**” the configuration display in this page.

#### 4.4.5 MSTP Port Configuration

This page allows configure the Port settings. Choose the Instance ID you want to configure. The MSTP enabled and linked up ports within the instance will be listed in this table.

Note that the ports not belonged to the Instance, or the ports not MSTP activated will not display. The meaning of the Path Cost, Priority, Link Type and Edge Port is the same as the definition of RSTP.

Port	Path Cost	Priority	Link Type	Edge Port
1	200000	128	Auto	Enable
2	200000	128	Auto	Enable

**Path Cost:** Enter a number between 1 and 200,000,000. This value represents the “cost” of the path to the other bridge from the transmitting bridge at the specified port.

**Priority:** Enter a value between 0 and 240, using multiples of 16. This is the value that decides which port should be blocked by priority in a LAN.

**Link Type:** There are 3 types for you select. **Auto**, **P2P** and **Share**.

Some of the rapid state transitions that are possible within RSTP depend upon whether the port of concern can only be connected to another bridge (i.e. it is served by a point-to-point LAN segment), or if it can be connected to two or more bridges (i.e. it is served by a shared-medium LAN segment). This function allows link status of the link to be manipulated administratively. “**Auto**” means to auto select P2P or Share mode. “**P2P**” means P2P is enabled, the 2 ends work in Full duplex mode. While “**Share**” is enabled, it means P2P is disabled, the 2 ends may connect through a share media and work in Half duplex mode.

**Edge:** A port directly connected to the end stations cannot create a bridging loop in the network. To configure this port as an edge port, set the port to the **Enable** state. When the non-bridge device connects an admin edge port, this port will be in blocking state and turn to forwarding state in 4 seconds.

Once you finish your configuration, click on **Apply** to save your settings.

#### 4.4.6 MSTP Information

This page allows you to see the current MSTP information.

Choose the **Instance ID** first. If the instance is not added, the information remains blank.

The **Root Information** shows the setting of the Root switch.

The **Port Information** shows the port setting and status of the ports within the instance.

### MSTP Information

Instance ID

#### Root Information

Root Address	0012.7760.ad4b
Root Priority	4096
Root Port	N/A
Root Path Cost	0
Max Age	20 second(s)
Hello Time	2 second(s)
Forward Delay	15 second(s)

#### Port Information

Port	Role	Port State	Path Cost	Port Priority	Link Type	Edge Port
5	Designated	Forwarding	200000	128	P2P Internal(MSTP)	Non-Edge
6	Designated	Forwarding	200000	128	P2P Internal(MSTP)	Non-Edge

Click on "**Reload**" to reload the MSTP information display.

#### 4.4.7 Multiple Super Ring (MSR)

The most common industrial network redundancy is to form a ring or loop. Typically, the managed switches are connected in series and the last switch is connected back to the first one. In such connection, you can implement Korenix Multiple Super Ring technology to get fastest recovery performance. After firmware version 2.8, the Multiple Super Ring (MSR)

**Multiple Super Ring (MSR)** technology is *Korenix's* 3<sup>rd</sup> generation Ring redundancy technology. This is patented and protected by *Korenix* and is used in countries all over the world. MSR ranks the fastest restore and failover time in the world, 0 ms for restore and about milliseconds level for failover for 100Base-TX copper port. The other interface may take longer time due to the IEEE 802.3 standard's specified of media characteristics.

**MultiRing** is an outstanding technology Korenix can support. Multiple rings can be aggregated within one switch by using different Ring ID. The maximum Ring number one switch can support is half of total port volume. The MultiRing offer several of Ring Technologies, like as **Super Ring, Rapid Super Ring, Super Chain** and **Any Ring**.

When implementing MultiRing, remember that the different rings can NOT use the same ring ID. The other settings are the same as above description.

**Rapid Dual Homing (RDH)** technology also facilitates *JetNet Managed Switch* to connect with a core managed switch easily and conveniently. With RDH technology, you can also couple several Rapid Super Rings or RSTP cloud together, which is also known as Auto Ring Coupling.

Since the firmware 2.8, the Rapid Dual Homing ID number supports from 0 to 255. The exact ID is counted by Rapid Dual Homing (0~7) and RDH Ext. ID (0~32), with the formula of mathematics – RDH ID x RDH Ext. ID, the RDH Rings up to 256. The RDH ID can't same as Ring ID. Because, the ring is controlled and negotiated by the ring control packet with specified ID. Therefore, the RDH ID and Super Ring ID can't be same. It is prohibited.

**TrunkRing:** The MultiRing technology is part of the MSR technology which combines the MSR with the port trunking technology. After multiple ports aggregated, this is so-call port trunking (Statically or learnt by LACP protocol), the Trunk ID can be one of the port ID of the MSR technology. Configured the port trunking first then you can add the Trunk group as a Ring Port in managed switch.

**Creat New Ring:** To create a Rapid Super Ring. Just fill in the Ring ID which has range from 0 to 31. If the name field is left blank, the name of this ring will be automatically naming with Ring ID. The available Ring ID range is 0~31.

**New Ring**

Ring ID	Name
1	

#### Ring Configuration

ID	Name	Version	Device Priority	Ring Port1	Path Cost	Ring Port2	Path Cost	Rapid Dual Homing	RDH Ext. ID	Ring Status
1	Ring1	Rapid Super Ring	128	Port 9	128	Port 10	128	Disable	0	Disable
2	Ring2	Rapid Super Ring	128	Port 1	128	Port 2	128	Disable	0	Disable
31	Ring31	Super Chain	128	Port 7	128	Port 8	128	Enable	7	Disable



**ID:** Once a Ring is created, this appears and can not be changed.

**Name:** This field will show the name of the Ring. If it is not filled in when creating, it will be automatically named by the rule "RingID".

**Version:** The version of Ring can be changed here. There are many modes to be chosen: Rapid Super Ring as default; Super ring for compatible with Korenix 1<sup>st</sup> general ring and Any Ring for compatible with other version of rings, and Super Ring supported after firmware v2.8.

**Device Priority:** The switch with highest priority (highest value) will be automatically selected as Ring Master. Then one of the ring ports in this switch will become forwarding port and the other one will become blocking port. If all of the switches have the same priority, the switch with the biggest MAC address will be selected as Ring Master.

**Ring Port1:** In Rapid Super Ring environment, you should have 2 Ring Ports. No matter this switch is Ring Master or not, when configuring RSR, 2 ports should be selected to be Ring Ports. For Ring Master, one of the ring ports will become the forwarding port and the other one will become the blocking port.

**Path Cost:** Change the Path Cost of Ring Port1. If this switch is the Ring Master of a Ring, then it determines the blocking port. The Port with higher Path Cost in the two ring Port will become the blocking port, If the Path Cost is the same, the port with larger port number will become the blocking port.

**Ring Port2:** Assign another port for ring connection

**Path Cost:** Change the Path Cost of Ring Port2

**Rapid Dual Homing:** Enable or Disable

**RDH Ext. ID:** the available RDH Ext. ID range is 0 to 7.

**Ring status:** To enable/disable the Ring. Please remember to enable the ring after you add it.

**Super Chain:** the Super Chain is new ring technology with flexible, scalability, compatibility and easy configurable. It includes 2 types of node Switch – Border Switch and Member Switch.

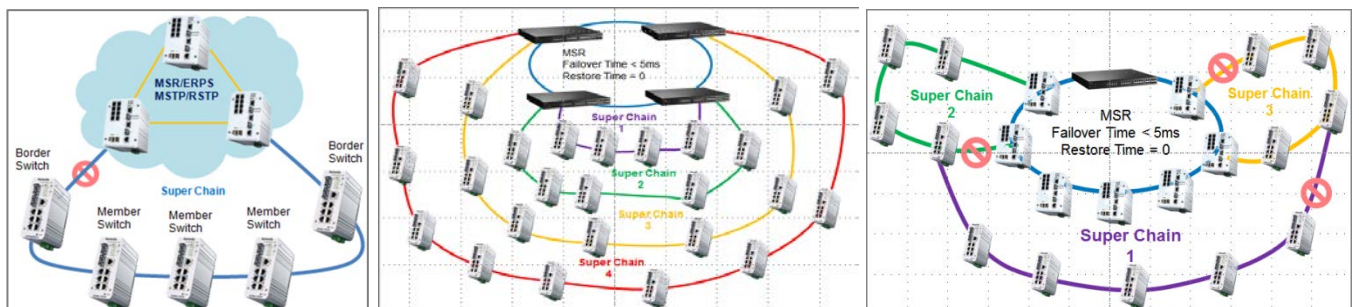

The **Border Switch** connects to foreigner Network, and the port is named edge port. The other switches connected with **Border Switch** are named **Member Switch**, the right figure show the typical Super Chain connective diagram. The port connects to the foreigner Network named Edge port, only present at Border Switch.

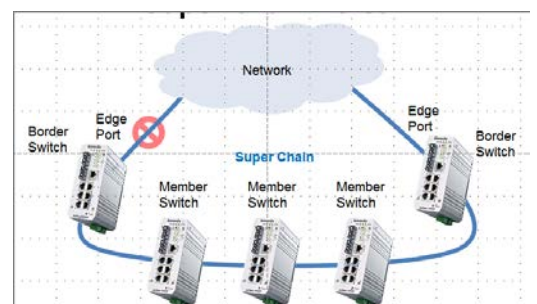

### Super Chain Configuration

**ID:** the ID is created at Ring Configuration Table described as before. The ID should be different with other Ring.

**Role:** Border or Member mode. The Switch connected with foreigner Network should be chosen in Border mode.

**Edge Port:** Select the port that connected with foreigner network.

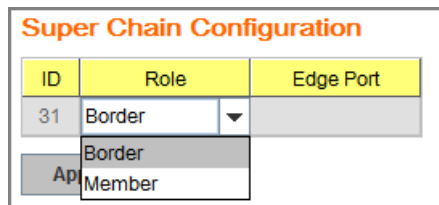

The screenshot shows a table titled "Super Chain Configuration". It has three columns: ID, Role, and Edge Port. The first row has ID "31", Role "Border", and an empty Edge Port field. A dropdown menu is open for the Role field, showing "Border" and "Member" options. Below the table, there is a button labeled "Apply".

ID	Role	Edge Port
31	Border	

Once you finish your configuration, click on **Apply** to save your settings, and you can click on **Reload** to update the configuration, and erase selected ring by click **Remove**.

#### 4.4.8 Multiple Super Ring Info

This page shows the MSR information.

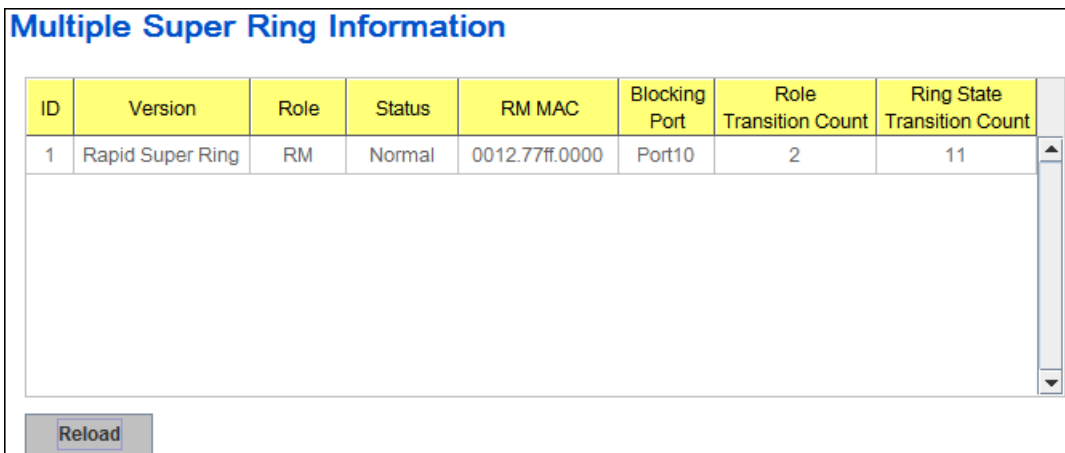

The screenshot shows a table titled "Multiple Super Ring Information". It has eight columns: ID, Version, Role, Status, RM MAC, Blocking Port, Role Transition Count, and Ring State Transition Count. The first row has ID "1", Version "Rapid Super Ring", Role "RM", Status "Normal", RM MAC "0012.77ff.0000", Blocking Port "Port10", Role Transition Count "2", and Ring State Transition Count "11". Below the table, there is a button labeled "Reload".

ID	Version	Role	Status	RM MAC	Blocking Port	Role Transition Count	Ring State Transition Count
1	Rapid Super Ring	RM	Normal	0012.77ff.0000	Port10	2	11

**ID:** Ring ID.

**Version:** which version of this ring, this field could be Rapid Super Ring, Super Ring, or Any Ring

**Role:** This Switch is RM or nonRM

**Status:** If this field is Normal which means the redundancy is approved. If any one of the link in this Ring is broken, then the status will be Abnormal.

**RM MAC:** The MAC address of Ring Master of this Ring. It helps to find the redundant path.

**Blocking Port:** This field shows which is blocked port of RM.

**Role Transition Count:** This means how many times this switch has changed its Role

from nonRM to RM or from RM to nonRM.

**Role state Transition Count:** This number means how many times the Ring status has been transformed between Normal and Abnormal state.

#### 4.4.9 Loop Protection

Since the 2.6 firmware version, The Switch supports loop eliminate function that based on per port or system configure, and prevents any looping caused by RSTP and MSR ring. The following figure shows the Loop Protect configuration.

Port	Loop Protection	Status
1	Enable	--
2	Enable	--
3	Enable	Loop Detected and Disabled
4	Enable	--
5	Enable	--
6	Enable	--
7	Enable	--
8	Enable	--
9	Enable	--
10	Enable	--

**Transmit interval:** setting the detect duration time between detect packet.

**Loop Protection:** Enable/ Disable Loop Protection function by per port.

**Status:** shows the port status. If there is looping occurred, it will show “Loop Detected and Disabled” information and the link indicator will not turn-off, and also the port is disabled by system. **Once the looping is fixed, the blocked port will keep at blocked state, and must be enabled by manual or perform system reset to recovery it.**

**Reload:** refresh and update the port status information.

#### 4.4.10 ERPS Configuration

The ERPS (Ethernet Ring Protection Switching) is a protection switching mechanisms and a protocol for Ethernet layer network (ETH) rings. Ethernet Rings can provide wide-area multipoint connectivity more economically due to their reduced number of links. The mechanisms and protocol defined in this Recommendation achieve highly reliable and stable protection; and never form loops, which would fatally affect network operation and service availability. The ERPS is an effort of ITU-T, under G8032 Recommendation to provide sub-50ms protection and recovery switching for Ethernet traffic in a ring topology and at the same time ensuring that there are no loops formed at the Ethernet layer. The ITU-T G.8032 v1 supported a single ring topology, and ITU-T G.8032 v2 supports multiple rings with ladder topology. In currently, the JetNet Switch only supports ITU-T G.8032 v1 with single ring topology.

Version	v1
Node State	Disabled
Node Role	RPL Owner
Control Channel	1
Ring Port 1	Port 1
Ring Port 2	Port 2
RPL Port	Ring Port 2

**ERPS:** Enable or disable the ITU-T G.8032 ERPS function.

**Version:** currently, the JetNet Switch only support ITU-T G.8032 v1

**Node State:** The current state of the node - Idle or Protection.

**Node Role:** The role of the node - **RPL** (Ring Protection Link) **Owner** or **Ring Node** (also known as Ring Protection Link node). The **RPL owner** is an Ethernet ring node adjacent to the **RPL**. The **Ring Node** is the link partner of **RPL Owner**.

**Control Channel:** Control Channel provide a communication channel for ring automatic protection switching (R-APS) information. The channel ID available range is 1 to 4094. It is similar as the Ring ID setting.

**Ring Port:** A ring link is bounded by two adjacent nodes and a port for a ring link is called a ring port.

**RPL Port:** The ring protection link (RPL) is the ring link which under normal conditions, i.e., without any failure or request, is blocked for traffic channel, to prevent the formation of loops.

Once finish the configuration, click on **Apply** to save your settings, and you can click on **Reload** to update the configuration.

#### 4.4.11 Command Lines:

Feature	Command Line
<b>Global (STP, RSTP, MSTP)</b>	
Enable	Switch(config)# spanning-tree enable
Disable	Switch (config)# spanning-tree disable
Mode (Choose the Spanning Tree mode)	Switch(config)# spanning-tree mode rst the rapid spanning-tree protocol (802.1w) stp the spanning-tree prtocol (802.1d) mst the multiple spanning-tree protocol (802.1s)
Bridge Priority	Switch(config)# spanning-tree priority <0-61440> valid range is 0 to 61440 in multiple of 4096 Switch(config)# spanning-tree priority 4096
Bridge Times	Switch(config)# spanning-tree bridge-times (forward Delay) (max-age) (Hello Time) Switch(config)# spanning-tree bridge-times 15 20 2  This command allows you configure all the timing in one time.
Forward Delay	Switch(config)# spanning-tree forward-time <4-30> Valid range is 4~30 seconds Switch(config)# spanning-tree forward-time 15
Max Age	Switch(config)# spanning-tree max-age <6-40> Valid range is 6~40 seconds Switch(config)# spanning-tree max-age 20
Hello Time	Switch(config)# spanning-tree hello-time <1-10> Valid range is 1~10 seconds Switch(config)# spanning-tree hello-time 2
<b>MSTP</b>	
Enter the MSTP Configuration Tree	Switch(config)# spanning-tree mst MSTMAP the mst instance number or range configuration enter mst configuration mode forward-time the forward dleay time

	<pre> hello-time    the hello time max-age       the message maximum age time max-hops      the maximum hops sync          sync port state of exist vlan entry Switch(config)# spanning-tree mst configuration Switch(config)# spanning-tree mst configuration Switch(config-mst)# abort         exit current mode and discard all changes end           exit current mode, change to enable mode and apply all               changes exit         exit current mode and apply all changes instance     the mst instance list         Print command list name         the name of mst region no           Negate a command or set its defaults quit        exit current mode and apply all changes revision     the revision of mst region show        show mst configuration </pre>
Region Configuration	<pre> Region Name: Switch(config-mst)# name NAME the name string Switch(config-mst)# name korenix Region Revision: Switch(config-mst)# revision &lt;0-65535&gt; the value of revision Switch(config-mst)# revision 65535 </pre>
Mapping Instance to VLAN (Ex: Mapping VLAN 2 to Instance 1)	<pre> Switch(config-mst)# instance &lt;1-15&gt; target instance number Switch(config-mst)# instance 1 vlan VLANMAP target vlan number(ex.10) or range(ex.1-10) Switch(config-mst)# instance 1 vlan 2 </pre>
Display Current MST Configuraion	<pre> Switch(config-mst)# show current Current MST configuration Name      [korenix] Revision  65535 Instance  Vlans Mapped ----- 0         1,4-4094 1         2 2         3 ----- Config HMAC-MD5 Digest: 0xB41829F9030A054FB74EF7A8587FF58D ----- </pre>
Remove Region Name	<pre> Switch(config-mst)# no name name configure revision revision configure instance the mst instance Switch(config-mst)# no name </pre>
Remove Instance example	<pre> Switch(config-mst)# no instance &lt;1-15&gt; target instance number Switch(config-mst)# no instance 2 </pre>
Show Pending MST Configuration	<pre> Switch(config-mst)# show pending Pending MST configuration Name      [] (-&gt;The name is removed by no name) Revision  65535 Instance  Vlans Mapped </pre>

	<pre> ----- 0      1,3-4094 1      2      (-&gt;Instance 2 is removed by no instance 2) ----- Config HMAC-MD5 Digest: 0x3AB68794D602FDF43B21C0B37AC3BCA8 ----- </pre>
Apply the setting and go to the configuration mode	<pre> Switch(config-mst)# quit apply all mst configuration changes Switch(config)# </pre>
Apply the setting and go to the global mode	<pre> Switch(config-mst)# end apply all mst configuration changes Switch# </pre>
<p>Abort the Setting and go to the configuration mode.</p> <p>Show Pending to see the new settings are not applied.</p>	<pre> Switch(config-mst)# abort discard all mst configuration changes Switch(config)# spanning-tree mst configuration Switch(config-mst)# show pending Pending MST configuration Name      [korenix] (-&gt;The nameis not applied after Abort settings.) Revision  65535 Instance  Vlans Mapped ----- 0      1,4-4094 1      2 2      3      (-&gt; The instance is not applied after Abort settings.) ----- Config HMAC-MD5 Digest: 0xB41829F9030A054FB74EF7A8587FF58D ----- </pre>
<b>RSTP</b>	
System RSTP Setting	The mode should be rst, the timings can be configured in global settings listed in above.
<b>Port Configuration Mode</b>	
Port Configuraiton	<pre> Switch(config)# interface fa1 Switch(config-if)# spanning-tree     bpdupfilter      a secure BPDU process on edge-port interfae     bpduguard        a secure response to invalid                     configurations(received BPDU sent by self)     cost              change an interafce's spanning-tree port path cost     edge-port         interface attached to a LAN segment that is at the                     end of a bridged LAN or to an end node     link-type         the link type for the Rapid Spanning Tree     mst               the multiple spanning-tree     port-priority     the spanning tree port priority </pre>
Port Path Cost	<pre> Switch(config-if)# spanning-tree cost &lt;1-200000000&gt; 16-bit based value range from 1-65535, 32-bit based value range from 1-200,000,000 Switch(config-if)# spanning-tree cost 200000 </pre>
Port Priority	<pre> Switch(config-if)# spanning-tree port-priority &lt;0-240&gt; Number from 0 to 240, in multiple of 16 Switch(config-if)# spanning-tree port-priority 128 </pre>
Link Type - Auto	Switch(config-if)# spanning-tree link-type auto
Link Type - P2P	Switch(config-if)# spanning-tree link-type point-to-point
Link Type – Share	Switch(config-if)# spanning-tree link-type shared
Edge Port	<pre> Switch(config-if)# spanning-tree edge-port enable Switch(config-if)# spanning-tree edge-port disable </pre>

<b>MSTP Port Configuration</b>	Switch(config-if)# spanning-tree mst MSTMAP cost <1-200000000> the value of mst instance port cost Switch(config-if)# spanning-tree mst MSTMAP port-priority <0-240> the value of mst instance port priority in multiple of 16																					
<b>Global Information</b>																						
<b>Active Information</b>	Switch# show spanning-tree active Spanning-Tree : Enabled Protocol : MSTP Root Address : 0012.77ee.eeee Priority : 32768 Root Path Cost : 0 Root Port : N/A Root Times : max-age 20, hello-time 2, forward-delay 15 Bridge Address : 0012.77ee.eeee Priority : 32768 Bridge Times : max-age 20, hello-time 2, forward-delay 15 BPDU transmission-limit : 3  <table border="1"> <thead> <tr> <th>Port</th> <th>Role</th> <th>State</th> <th>Cost</th> <th>Prio.Nbr</th> <th>Type</th> <th>Aggregated</th> </tr> </thead> <tbody> <tr> <td>fa1</td> <td>Designated</td> <td>Forwarding</td> <td>200000</td> <td>128.1</td> <td>P2P(RSTP)</td> <td>N/A</td> </tr> <tr> <td>fa2</td> <td>Designated</td> <td>Forwarding</td> <td>200000</td> <td>128.2</td> <td>P2P(RSTP)</td> <td>N/A</td> </tr> </tbody> </table>	Port	Role	State	Cost	Prio.Nbr	Type	Aggregated	fa1	Designated	Forwarding	200000	128.1	P2P(RSTP)	N/A	fa2	Designated	Forwarding	200000	128.2	P2P(RSTP)	N/A
Port	Role	State	Cost	Prio.Nbr	Type	Aggregated																
fa1	Designated	Forwarding	200000	128.1	P2P(RSTP)	N/A																
fa2	Designated	Forwarding	200000	128.2	P2P(RSTP)	N/A																
<b>RSTP Summary</b>	Switch# show spanning-tree summary Switch is in rapid-stp mode. BPDU skewing detection disabled for the bridge. Backbonefast disabled for bridge. Summary of connected spanning tree ports : #Port-State Summary Blocking Listening Learning Forwarding Disabled ----- 0 0 0 2 8 #Port Link-Type Summary AutoDetected PointToPoint SharedLink EdgePort ----- 9 0 1 9																					
<b>Port Info</b>	Switch# show spanning-tree port detail fa7 (Interface_ID) Rapid Spanning-Tree feature Enabled Port 128.6 as Disabled Role is in Disabled State Port Path Cost 200000, Port Identifier 128.6 RSTP Port Admin Link-Type is Auto, Oper Link-Type is Point-to-Point RSTP Port Admin Edge-Port is Enabled, Oper Edge-Port is Edge Designated root has priority 32768, address 0012.7700.0112 Designated bridge has priority 32768, address 0012.7760.1aec Designated Port ID is 128.6, Root Path Cost is 600000 Timers : message-age 0 sec, forward-delay 0 sec  Link Aggregation Group: N/A, Type: N/A, Aggregated with: N/A  BPDU: sent 43759 , received 4854 TCN : sent 0 , received 0 Forwarding-State Transmit count 12 Message-Age Expired count																					
<b>MSTP Information</b>																						
<b>MSTP Configuraiton</b>	Switch# show spanning-tree mst configuration Current MST configuration (MSTP is Running) Name [korenix] Revision 65535 Instance Vlans Mapped ----- 0 1,4-4094 1 2																					



	<pre> 2      3 ----- Config HMAC-MD5 Digest: 0xB41829F9030A054FB74EF7A8587FF58D ----- </pre>
Display all MST Information	<pre> Switch# show spanning-tree mst ##### MST00   vlans mapped: 1,4-4094 Bridge        address 0012.77ee.eeee priority 32768 (sysid 0) Root          this switch for CST and IST Configured    max-age 2, hello-time 15, forward-delay 20, max-hops 20  Port  Role          State      Cost    Prio.Nbr  Type ----- fa1   Designated  Forwarding 200000  128.1    P2P Internal(MSTP) fa2   Designated  Forwarding 200000  128.2    P2P Internal(MSTP)  ##### MST01   vlans mapped: 2 Bridge        address 0012.77ee.eeee priority 32768 (sysid 1) Root          this switch for MST01  Port  Role          State      Cost    Prio.Nbr  Type ----- fa1   Designated  Forwarding 200000  128.1    P2P Internal(MSTP) fa2   Designated  Forwarding 200000  128.2    P2P Internal(MSTP) </pre>
MSTP Root Information	<pre> Switch# show spanning-tree mst root MST   Root      Root   Root   Root   Max   Hello   Fwd Instance  Address    Priority Cost   Port   age    time    dly ----- MST00  0012.77ee.eeee 32768  0     N/A    20    2     15 MST01  0012.77ee.eeee 32768  0     N/A    20    2     15 MST02  0012.77ee.eeee 32768  0     N/A    20    2     15 </pre>
MSTP Instance Information	<pre> Switch# show spanning-tree mst 1 ##### MST01   vlans mapped: 2 Bridge        address 0012.77ee.eeee priority 32768 (sysid 1) Root          this switch for MST01  Port  Role          State      Cost    Prio.Nbr  Type ----- fa1   Designated  Forwarding 200000  128.1    P2P Internal(MSTP) fa2   Designated  Forwarding 200000  128.2    P2P Internal(MSTP) </pre>
MSTP Port Information	<pre> Switch# show spanning-tree mst interface fa1 Interface fastethernet1 of MST00 is Designated Forwarding Edge Port : Edge (Edge)          BPDU Filter : Disabled Link Type : Auto (Point-to-point) BPDU Guard : Disabled Boundary : Internal(MSTP) BPDUs : sent 6352, received 0  Instance  Role          State      Cost    Prio.Nbr  Vlans mapped ----- 0         Designated  Forwarding 200000  128.1    1,4-4094 1         Designated  Forwarding 200000  128.1    2 2         Designated  Forwarding 200000  128.1    3 </pre>
<b>Multiple Super Ring</b>	
Create or configure a Ring	<pre> Switch(config)# multiple-super-ring 1 Ring 1 created Switch(config-multiple-super-ring)# </pre>



	<b>Note: 1 is the target Ring ID which is going to be created or configured.</b>
Super Ring Version	<p>Switch(config-multiple-super-ring)# version  any-ring any ring auto detection  default set default to rapid super ring  rapid-super-ring rapid super ring  super-ring super ring  super-chain super chain</p> <p>Switch(config-multiple-super-ring)# version rapid-super-ring → Set ring type</p>
Super Chain	<p><b>Super-Chain Border Configuration</b>  Switch(config-multiple-super-ring)# super-chain border → sets the Ring 1 perform as Super-Chain , and the Switch acts as a border, otherwise the Switch will be a member.  Switch(config-multiple-super-ring)# super-chain edge-port fa1 → sets the fast Ethernet port-1 as edge-port.</p> <p><b>Super-Chain Member Configuration</b>  Switch(config-multiple-super-ring)#super-chain member  Switch(config-multiple-super-ring)#super-chain disable</p> <p><b>Show Chain Status</b>  Switch# show multiple-super-ring</p>
Priority	<p>Switch(config-multiple-super-ring)# priority  &lt;0-255&gt; valid range is 0 to 255  default set default</p> <p>Switch(config)# super-ring priority 100</p>
Ring Port	<p>Switch(config-multiple-super-ring)# port  IFLIST Interface list, ex: fa1,fa3-5,gi8-10  cost path cost</p> <p>Switch(config-multiple-super-ring)# port fa1,fa2</p>
Ring Port Cost	<p>Switch(config-multiple-super-ring)# port cost  &lt;0-255&gt; valid range is 0 or 255  default set default (128)valid range is 0 or 255</p> <p>Switch(config-multiple-super-ring)# port cost 100  &lt;0-255&gt; valid range is 0 or 255  default set default (128)valid range is 0 or 255</p> <p>Switch(config-super-ring-plus)# port cost 100 200  Set path cost success.</p>
Rapid Dual Homing	<p>Switch(config-multiple-super-ring)# rapid-dual-homing enable</p> <p>Switch(config-multiple-super-ring)# rapid-dual-homing disable</p> <p>Switch(config-multiple-super-ring)# rapid-dual-homing port  IFLIST Interface name, ex: fastethernet1 or gi8  auto-detect up link auto detection  IFNAME Interface name, ex: fastethernet1 or gi8</p> <p>Switch(config-multiple-super-ring)# rapid-dual-homing port fa3,fa5-6  set Rapid Dual Homing port success.</p> <p>Switch(config)# multiple-super-ring 1  Switch(config-multiple-super-ring)# start  Switch(config-multiple-super-ring)# rapid-dual-homing enable  Switch(config-multiple-super-ring)# rapid-dual-homing extension  &lt;0-7&gt; extension ID 0-7 (default is 0)</p>

	Note: auto-detect is recommended for dual Homing.
<b>Ring Info</b>	
Ring Info	<pre>Switch# show multiple-super-ring [Ring ID] [Ring1] Ring1 Current Status : Disabled Role           : Disabled Ring Status    : Abnormal Ring Manager   : 0000.0000.0000 Blocking Port  : N/A Giga Copper    : N/A Configuration : Version        : Rapid Super Ring Priority        : 128 Ring Port      : fa1, fa2 Path Cost      : 100, 200 Dual-Homing II : Disabled Statistics : Watchdog sent   0, received   0, missed   0 Link Up  sent   0, received   0 Link Down sent  0, received   0 Role Transition count 0 Ring State Transition count 1</pre> <p>Ring ID is optional. If the ring ID is typed, this command will only display the information of the target Ring.</p>
<b>Loop Protect</b>	
loop-protect	<pre><b>Ethernet loop protection</b> Switch(config)# loop-protect  shows parameters of loop protect enable           Enable loop protection disable          Disable loop protection transmit-interval Set the transmission frequency of loop                   protection in seconds Switch(config)# loop-protect enable all                   Ethernet loop protection is enabled on all interfaces! Switch(config)# loop-protect transmit-interval                   &lt;1-10&gt; Valid range is 1~10 second(s) Switch(config)# loop-protect transmit-interval 3 →(set interval time –                   3 seconds) Switch(config)# loop-protect enable fa6 → (fa1~7, gi7~gi10)                   Set fa6 Ethernet loop protection enabled! Switch# sh loop-protect →(show current loop-protect detected information) Loop protect information : Loop Protect Interface : fa6,gi10 Transmit Interval(sec) : 3 Loop Detected Interface : N/A</pre>

## 4.5 VLAN

A Virtual LAN (VLAN) is a “logical” grouping of nodes for the purpose of limiting a broadcast domain to specific members of a group without physically grouping the members together. That means, VLAN allows you to isolate network traffic so that only members of VLAN could receive traffic from the same VLAN members. Basically, creating a VLAN from a switch is the logical equivalent of physically reconnecting a group of network devices to another Layer 2 switch, without actually disconnecting these devices from their original switches.

The Industrial Ethernet Switch supports 802.1Q VLAN. 802.1Q VLAN is also known as Tag-Based VLAN. This Tag-Based VLAN allows VLAN to be created across different switches (see Figure 1). IEEE 802.1Q tag-based VLAN makes use of VLAN control information stored in a VLAN header attached to IEEE 802.3 packet frames. This tag contains a VLAN Identifier (VID) that indicates which VLAN a frame belongs to. Since each switch only has to check a frame’s tag, without the need to dissect the contents of the frame, this also saves a lot of computing resources within the switch.

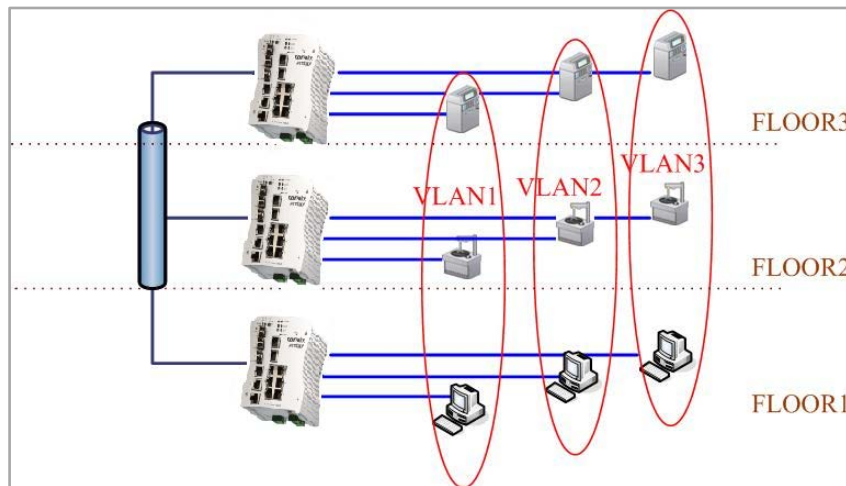
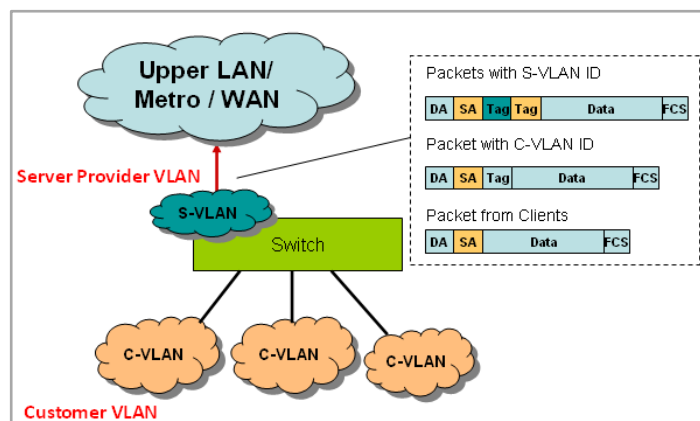

Figure 4.5.1 802.1Q VLAN

### QinQ

In the firmware V2.4, Korenix release extended VLAN feature, QinQ. The QinQ is originally designed to expand the number of VLANs by adding a tag to the 802.1Q packets. The original VLAN is usually identified as Customer VLAN (C-VLAN) and the new added tag - as Service VLAN(S-VLAN). By adding the additional tag, QinQ increases the possible number of VLANs. After QinQ enabled, the Switch can reach up to 256x256



VLANs. With different standard tags, it also improves the network security.

VLAN Configuration group enables you to Add/Remove VLAN, configure QinQ, port

Ingress/Egress parameters and view VLAN table.

Following commands are included in this group:

4.5.1 VLAN Port Configuration

4.5.2 VLAN Configuration

4.5.3 GVRP Configuration

4.5.4 VLAN Table

4.5.5 CLI Commands of the VLAN

#### 4.5.1 VLAN Port Configuration

VLAN Port Configuration allows you to set up VLAN port parameters to specific port. These parameters include PVID, Accept Frame Type and Ingress Filtering.

Figure 4.5.2 Web UI of VLAN Port configuration.

VLAN Port Configuration				
VLAN Port Configuration				
Port	PVID	Tunnel Mode	Accept Frame Type	Ingress Filtering
1	1	None	Admit All	Disable
2	1	None	Admit All	Disable
3	1	802.1Q Tunnel	Admit All	Disable
4	1	802.1Q Tunnel Uplink	Admit All	Disable
5	1	None	Admit All	Disable
6	1	None	Admit All	Disable
7	5	None	Admit All	Disable
8	4	None	Admit All	Disable
9	5	None	Admit All	Disable
10	2	None	Admit All	Disable

Apply

**PVID:** The abbreviation of the **Port VLAN ID**. Enter port VLAN ID here. PVID allows the switches to identify which port belongs to which VLAN. To keep things simple, it is recommended that PVID is equivalent to VLAN IDs.

The values of PVIDs are from 0 to 4095. But, 0 and 4095 are reserved. You can't input these 2 PVIDs. 1 is the default value. 2 to 4094 are valid and available in this column. Type the PVID you'd like to configure here.

**Tunnel Mode:** This is the new command for QinQ. The command includes None, 802.1Q Tunnel and 802.1Q Tunnel Uplink. The figure shows the relationship between 802.1Q Tunnel and 802.1Q Tunnel Uplink.

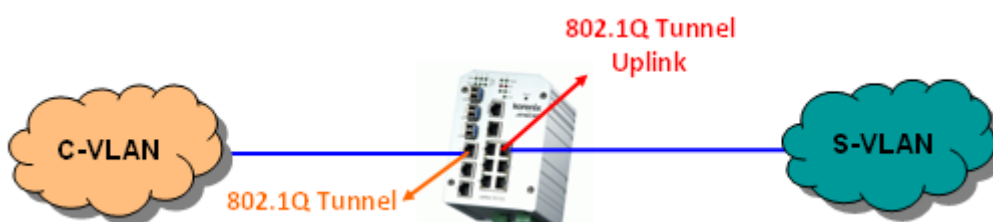

Following is the modes you can select.

**None:** Remain VLAN setting, no QinQ.

**802.1Q Tunnel:** The QinQ command applied to the ports which connect to the C-VLAN. The port receives tagged frame from the C-VLAN. Add a new tag (Port VID) as S-VLAN VID. When the packets are forwarded to C-VLAN, the S-VLAN tag is removed.

After 802.1Q Tunnel mode is assigned to a port, the egress setting of the port should be “**Untag**”, it indicates the egress packet is always untagged. This is configured in Static VLAN Configuration table. Please refer to the VLAN Configuration chapter in below.

**802.1Q Tunnel Uplink:** The QinQ command applied to the ports which connect to the S-VLAN. The port receives tagged frame from the S-VLAN. When the packets are forwarded to S-VLAN, the S-VLAN tag is kept.

After 802.1Q Tunnel Uplink mode is assigned to a port, the egress setting of the port should be “**Tag**”, it indicates the egress packet is always tagged. This is configured in Static VLAN Configuration table. Please refer to the VLAN Configuration chapter in below.

For example, the VID of S-VLAN/Tunnel Uplink is 10, the VID of C-VLAN/Tunnel is 5. The 802.1Q Tunnel port receives tag 5 from C-VLAN, add tag 10 to the packet. When the packets are forwarded to S-VLAN, tag 10 is kept.

**Accept Frame Type:** This column defines the accepted frame type of the port. There are 2 modes you can select, **Admit All** and **Tag Only**. Admit All mode means that the port can accept both tagged and untagged packets. Tag Only mode means that the port can only accept tagged packets.

**Ingress Filtering:** Ingress filtering helps VLAN engine to filter out undesired traffic on a port. When Ingress Filtering is enabled, the port checks whether the incoming frames belong to the VLAN they claimed or not. Then the port determines if the frames can be processed or not. For example, if a tagged frame from Engineer VLAN is received, and Ingress Filtering is enabled, the switch will determine if the port is on the Engineer VLAN's Egress list. If it is, the frame can be processed. If it's not, the frame would be dropped.

After 802.1Q Tunnel or 802.1Q Tunnel Uplink is enabled, the Ingress Filtering can not be configured.

#### 4.5.2 VLAN Configuration

In this page, you can assign Management VLAN, create the static VLAN, and assign the Egress rule for the member ports of the VLAN.

Figure 4.5.2.1 Web UI of the VLAN Configuration.

### VLAN Configuration

**Management VLAN ID**

**Apply**

**Static VLAN**

VLAN ID	Name
<input type="text"/>	<input type="text"/>

**Add**

**Static VLAN Configuration**

VLAN ID	Name	1	2	3	4	5	6	7	8	9	10
1	VLAN1	U	U	U	U	U	U	U	U	U	U

**Apply** **Remove** **Reload**

**Management VLAN ID:** The switch supports management VLAN. The management VLAN ID is the VLAN ID of the CPU interface so that only member ports of the management VLAN can ping and access the switch. The default management VLAN ID is “1”.

**Static VLAN:** You can assign a VLAN ID and VLAN Name for new VLAN here.

**VLAN ID** is used by the switch to identify different VLANs. Valid VLAN ID is between 1 and 4094. 1 is the default VLAN.

**VLAN Name** is a reference for network administrator to identify different VLANs. The available character is 12 for you to input. If you don't input VLAN name, the system will automatically assign VLAN name for the VLAN. The rule is VLAN (VLAN ID).

### Static VLAN

VLAN ID	NAME
<input type="text" value="3"/>	<input type="text" value="test"/>

**Add** **Help**

Figure 4.5.2.2 The steps to create a new VLAN: Type VLAN ID and NAME, and press **Add** to create a new VLAN. Then you can see the new VLAN in the Static VLAN Configuration table. Refer to Figure 4.5.2.3

After created the VLAN, the status of the VLAN will remain in Unused until you add ports to the VLAN.

**Note:** Before you change the management VLAN ID by Web and Telnet, remember that the port attached by the administrator should be the member port of the management VLAN; otherwise the administrator can't access the switch via the network.

**Note:** Currently the Switch only support max 64 group VLAN.

### Static VLAN Configuration

You can see the created VLANs and specify the egress (outgoing) port rule to be

**Untagged or Tagged** here.

Figure 4.5.2.3 Static VLAN Configuration table. You can see that new VLAN 3 is created. VLAN name is test. Egress rules of the ports are not configured now.

### Static VLAN Configuration

VLAN ID	NAME	1	2	3	4	5	6	7	8	9	10
1	VLAN1	U	U	U	U	U	U	U	U	U	U
2	VLAN2	--	--	--	--	--	--	--	--	--	--
3	test	--	--	--	--	--	--	--	--	--	--

Apply Remove Reload

Figure 4.5.2.4 Configure Egress rule of the ports.

### Static VLAN Configuration

VLAN ID	NAME	1	2	3	4	5	6	7	8	9	10
1	VLAN1	U	U	U	U	U	U	U	U	U	U
2	VLAN2	U	U	U	U	--	--	--	--	--	--
3	test	--	--	--	--	U	T	T	T	T	T

Apply Remove Reload

-- : Not available

**U: Untag:** Indicates that egress/outgoing frames are not VLAN tagged.

**T : Tag:** Indicates that egress/outgoing frames are to be VLAN tagged.

Steps to configure Egress rules: Select the VLAN ID. Entry of the selected VLAN turns to light blue. Assign Egress rule of the ports to **U** or **T**. Press **Apply** to apply the setting. If you want to remove one VLAN, select the VLAN entry. Then press **Remove** button.

### 4.5.3 GVRP configuration

GVRP allows users to set-up VLANs automatically rather than manual configuration on every port of every switch in the network.

**GVRP Protocol:** Allow user to enable/disable GVRP globally.

**State:** After enable GVRP globally, here still can enable/disable GVRP by port.

**Join Timer:** Controls the interval of sending the GVRP Join BPDU. An instance of this timer is required on a per-Port, per-GARP Participant basis

**Leave Timer:** Control the time to release the GVRP reservation after received the GVRP Leave BPDU. An instance of the timer is required for each state machine that is in the LV state

**Leave All Timer:** Controls the period to initiate the garbage collection of registered VLAN. The timer is required on a per-Port, per-GARP Participant basis

#### GVRP Configuration

**GVRP Protocol** Enable ▼

Port	State	Join Timer	Leave Timer	Leave All Timer
1	Disable ▼	20	60	1000
2	Disable ▼	20	60	1000
3	Disable ▼	20	60	1000
4	Disable ▼	20	60	1000
5	Disable ▼	20	60	1000
6	Disable ▼	20	60	1000
7	Disable ▼	20	60	1000
8	Disable ▼	20	60	1000
9	Disable ▼	20	60	1000
10	Disable ▼	20	60	1000

Note: Timer unit is centiseconds.

Apply

### 4.5.4 VLAN Table

This table shows you current settings of your VLAN table, including VLAN ID, Name, Status, and Egress rule of the ports.

#### VLAN Table

**VLAN Table**

VLAN ID	Name	Status	1	2	3	4	5	6	7	8	9	10
1	VLAN1	Static	U	U	U	U	U	U	U	U	U	U
2	VLAN2	Unused	--	--	--	--	--	--	--	--	--	--
3	test	Static	--	--	U	U	--	T	T	T	--	--

Reload

**VLAN ID:** ID of the VLAN.

**Name:** Name of the VLAN.

**Status:** **Static** shows this is a manually configured static VLAN. **Unused** means this VLAN is created by UI/CLI and has no member ports. This VLAN is not workable yet. **Dynamic** means this VLAN is learnt by GVRP.



After created the VLAN, the status of this VLAN will remain in Unused status until you add ports to the VLAN.

#### 4.5.5 CLI Commands of the VLAN

Command Lines of the VLAN port configuration, VLAN configuration and VLAN table display

Feature	Command Line
<b>VLAN Port Configuration (Go to the port interface configuration mode first.)</b>	
Port Interface Configuraion	Switch# conf ter Switch(config)# interface fa5 Switch(config-if)#
VLAN Port PVID	Switch(config-if)# switchport trunk native vlan 2 Set port default vlan id to 2 success
<b>QinQ Tunnel Mode</b>  802.1Q Tunnel = access  802.1Q Tunnel Uplink = uplink	Switch(config-if)# switchport dot1q-tunnel mode Set the interface as an IEEE 802.1Q tunnel mode Switch(config-if)# switchport dot1q-tunnel mode access Set the interface as an access port of IEEE 802.1Q tunnel mode uplink Set the interface as an uplink port of IEEE 802.1Q tunnel mode
Port Accept Frame Type	Switch(config-if)# acceptable frame type all any kind of frame type is accepted! Switch(config-if)# acceptable frame type vlantaggedonly only vlan-tag frame is accepted!
Ingress Filtering (for fast Ethernet port 1)	Switch(config-if)# ingress filtering enable ingress filtering enable Switch(config-if)# ingress filtering disable ingress filtering disable
Egress rule – Untagged (for VLAN 2)	Switch(config-if)# switchport access vlan 2 switchport access vlan - success
Egress rule – Tagged (for VLAN 2)	Switch(config-if)# switchport trunk allowed vlan add 2
Display – Port Ingress Rule (PVID, Ingress Filtering, Acceptable Frame Type)	Switch# show interface fa1 Interface fastethernet1 Administrative Status : Enable Operating Status : Not Connected Duplex : Auto Speed : Auto Flow Control :off Default Port VLAN ID: 2 Ingress Filtering : Disabled Acceptable Frame Type : All Port Security : Disabled Auto Negotiation : Enable Loopback Mode : None STP Status: disabled Default CoS Value for untagged packets is 0. Mdix mode is Auto. Medium mode is Copper.

Display – Port Egress Rule (Egress rule, IP address, status)	<pre>Switch# show running-config ..... ! interface fastethernet1   switchport access vlan 1   switchport access vlan 3   switchport trunk native vlan 2 ..... interface vlan1   ip address 192.168.10.8/24   no shutdown</pre>
QinQ Information – 802.1Q Tunnel	<pre>Switch# show dot1q-tunnel dot1q-tunnel mode port 1 : normal port 2 : normal port 3 : normal port 4 : normal port 5 : access port 6 : uplink port 7 : normal port 8 : normal port 9 : normal port 10 : normal</pre>
QinQ Information – Show Running	<pre>Switch# show running-config Building configuration...  Current configuration: hostname Switch vlan learning independent ..... ..... interface fastethernet5   switchport access vlan add 1-2,10   switchport dot1q-tunnel mode access ! interface fastethernet6   switchport access vlan add 1-2   switchport trunk allowed vlan add 10   switchport dot1q-tunnel mode uplink !</pre>
<b>VLAN Configuration</b>	
Create VLAN (2)	<pre>Switch(config)# vlan 2 vlan 2 success  Switch(config)# interface vlan 2 Switch(config-if)#</pre> <p><i>Note: In CLI configuration, you should create a VLAN interface first. Then you can start to add/remove ports. Default status of the created VLAN is unused until you add member ports to it.</i></p>
Remove VLAN	<pre>Switch(config)# no vlan 2 no vlan success</pre> <p><i>Note: You can only remove the VLAN when the VLAN is in unused mode.</i></p>

VLAN Name	<pre>Switch(config)# vlan 2 vlan 2 has exists Switch(config-vlan)# name v2  Switch(config-vlan)# no name  Note: Use no name to change the name to default name, VLAN VID.</pre>
VLAN description	<pre>Switch(config)# interface vlan 2 Switch(config-if)# Switch(config-if)# description this is the VLAN 2  Switch(config-if)# no description -&gt;Delete the description.</pre>
IP address of the VLAN	<pre>Switch(config)# interface vlan 2 Switch(config-if)# Switch(config-if)# ip address 192.168.10.18/24  Switch(config-if)# no ip address 192.168.10.8/24 -&gt;Delete the IP address</pre>
Create multiple VLANs (VLAN 5-10)	<pre>Switch(config)# interface vlan 5-10</pre>
Shut down VLAN	<pre>Switch(config)# interface vlan 2 Switch(config-if)# shutdown  Switch(config-if)# no shutdown -&gt;Turn on the VLAN</pre>
Display – VLAN table	<pre>Switch# sh vlan VLAN Name   Status  Trunk Ports          Access Ports ----  - 1   VLAN1    Static   -                    fa1-7,gi8-10 2   VLAN2    Unused  -                    - 3   test     Static   fa4-7,gi8-10        fa1-3,fa7,gi8-10</pre>
Display – VLAN interface information	<pre>Switch# show interface vlan1 interface vlan1 is up, line protocol detection is disabled index 14 metric 1 mtu 1500 &lt;UP,BROADCAST,RUNNING,MULTICAST&gt; HWaddr: 00:12:77:ff:01:b0 inet 192.168.10.100/24 broadcast 192.168.10.255 input packets 639, bytes 38248, dropped 0, multicast packets 0 input errors 0, length 0, overrun 0, CRC 0, frame 0, fifo 0, missed 0 output packets 959, bytes 829280, dropped 0 output errors 0, aborted 0, carrier 0, fifo 0, heartbeat 0, window 0 collisions 0</pre>
<b>GVRP configuration</b>	
GVRP enable/disable	<pre>Switch(config)# gvrp mode disable  Disable GVRP feature globally on the switch enable   Enable GVRP feature globally on the switch Switch(config)# gvrp mode enable Gvrp is enabled on the switch!</pre>
Configure GVRP timer Join timer /Leave timer/ LeaveAll timer	<pre>Switch(config)# inter fa1 Switch(config-if)# garp timer &lt;10-10000&gt; Switch(config-if)# garp timer 20 60 1000 Note: The unit of these timer is centisecond</pre>
<b>Management VLAN</b>	
Management VLAN	<pre>Switch(config)# int vlan 1 (Go to management VLAN) Switch(config-if)# no shutdown</pre>
Display	<pre>Switch# show running-config .... !</pre>

```
interface vlan1
ip address 192.168.10.17/24
ip igmp
no shutdown
!
....
```

## 4.6 Private VLAN

The private VLAN helps to resolve the primary VLAN ID shortage, client ports' isolation and network security issues. The Private VLAN provides primary and secondary VLAN within a single switch.

**Primary VLAN:** The uplink port is usually the primary VLAN. A primary VLAN contains promiscuous ports that can communicate with lower Secondary VLANs.

**Secondary VLAN:** The client ports are usually defined within secondary VLAN. The secondary VLAN includes Isolated VLAN and Community VLAN. The client ports can be isolated VLANs or can be grouped in the same Community VLAN. The ports within the same community VLAN can communicate with each other. However, the isolated VLAN ports can not.

The figure shows the typical Private VLAN network. The SCADA/Public Server or NMS workstation is usually located in primary VLAN. The clients PCs or Rings are located within Secondary.

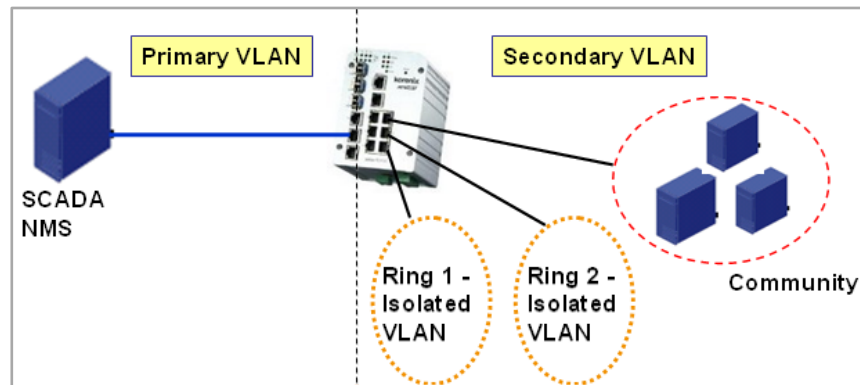

Private VLAN (PVLAN) Configuration group enables you to Configure PVLAN, PVLAN Port and see the PVLAN Information.

Following commands are included in this group:

4.6.1 PVLAN Configuration

4.6.2 PVLAN Port Configuration

4.6.3 CLI Commands of the PVLAN

### 4.6.1 PVLAN Configuration

PVLAN Configuration allows you to assign Private VLAN type. After created VLAN in VLAN Configuration page, the available VLAN ID will display here. Choose the Private VLAN types for each VLAN you want configure.

**None:** The VLAN is Not included in Private VLAN.

**Primary:** The VLAN is the Primary VLAN. The member ports can communicate with secondary ports.

**Isolated:** The VLAN is the Isolated VLAN. The member ports of the VLAN are isolated.

**Community:** The VLAN is the Community VLAN. The member ports of the VLAN can communicate with each other.

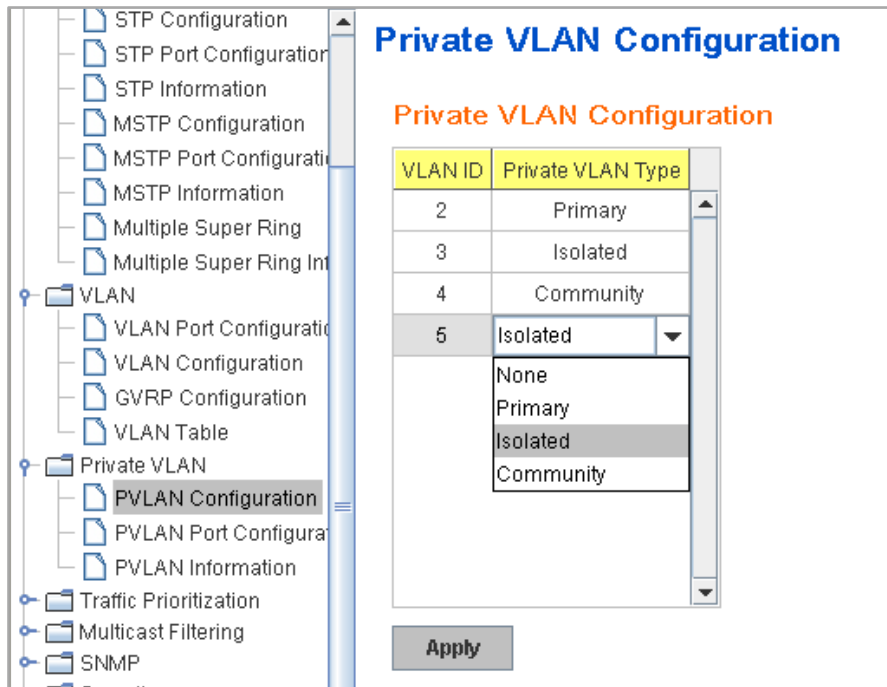

#### 4.6.2 PVLAN Port Configuration

PVLAN Port Configuration page allows configure Port Configuration and Private VLAN Association.

##### Private VLAN Association

**Secondary VLAN:** After the Isolated and Community VLAN Type is assigned in Private VLAN Configuration page, the VLANs are belonged to the Secondary VLAN and displayed here.

**Primary VLAN:** After the Primary VLAN Type is assigned in Private VLAN Configuration page, the secondary VLAN can associate to the Primary VLAN ID. Select the Primary VLAN ID here.

**Note:** Before configuring PVLAN port type, the Private VLAN Association should be done first.

##### Port Configuraion

##### **PVLAN Port Type :**

**Normal:** The Normal port is None PVLAN ports, it remains its original VLAN setting.

**Host:** The Host type ports can be mapped to the Secondary VLAN.

**Promiscuous:** The promiscuous port can be associated to the Primary VLAN.

**VLAN ID:** After assigned the port type, the web UI display the available VLAN ID the port can associate to.

For example:

**1. VLAN Create:** VLAN 2-5 are created in VLAN Configuration page.

**2. Private VLAN Type:** VLAN 2-5 has its Private VLAN Type configured in Private VLAN Configuration page.

VLAN 2 is belonged to Primary VLAN.

VLAN 3-5 are belonged to secondary VLAN (Isolated or Community).

**3. Private VLAN Association:** Associate VLAN 3-5 to VLAN 2 in Private VLAN Association first.

**4. Private VLAN Port Configuraiton**

VLAN 2 – Primary -> The member port of VLAN 2 is promiscuous port.

VLAN 3 – Isolated -> The Host port can be mapped to VLAN 3.

VLAN 4 – Community -> The Host port can be mapped to VLAN 3.

VLAN 5 – Community -> The Host port can be mapped to VLAN 3.

**5. Result:**

VLAN 2 -> VLAN 3, 4, 5; member ports can communicate with ports in secondary VLAN.

VLAN 3 -> VLAN 2, member ports are isolated, but it can communicate with member port of VLAN 2..

VLAN 4 -> VLAN 2, member ports within the community can communicate with each other and communicate with member port of VLAN 2.

VLAN 5 -> VLAN 2, member ports within the community can communicate with each other and communicate with member port of VLAN 2.

**Private VLAN Port Configuration**

**Port Configuration**

Port	PVLAN Port Type	VLAN ID
1	Normal	None
2	Normal	None
3	Normal	None
4	Normal	None
5	Normal	None
6	Normal	None
7	Host	5
8	Host	4
9	Host	3
10	Promiscuous	2

**Private VLAN Association**

Secondary VLAN	Primary VLAN
3	2
4	2
5	2

**4.6.3 Private VLAN Information**

This page allows you to see the Private VLAN information.

**Private VLAN Information**

Primary VLAN	Secondary VLAN	Secondary VLAN Type	Ports
2	3	Isolated	10,9
2	4	Community	10,8
2	5	Community	10,7

#### 4.6.4 CLI Command of the PVLAN

Command Lines of the Private VLAN configuration

Feature	Command Line
<b>Private VLAN Configuration</b>	
Create VLAN	Switch(config)# vlan 2 vlan 2 success Switch(config-vlan)# end        End current mode and change to enable mode exit       Exit current mode and down to previous mode list       Print command list name       Assign a name to vlan no          no private-vlan    Configure a private VLAN
Private VLAN Type	<b>Go to the VLAN you want configure first.</b> Switch(config)# vlan (VID)
Choose the Types	Switch(config-vlan)# private-vlan community    Configure the VLAN as an community private VLAN isolated     Configure the VLAN as an isolated private VLAN primary      Configure the VLAN as a primary private VLAN
Primary Type	Switch(config-vlan)# private-vlan primary <cr>
Isolated Type	Switch(config-vlan)# private-vlan isolated <cr>
Community Type	Switch(config-vlan)# private-vlan community <cr>
<b>Private VLAN Port Configuraiton</b>	
Go to the port configuraiton	Switch(config)# interface (port_number, ex: gi9) Switch(config-if)# switchport private-vlan host-association    Set the private VLAN host association mapping             map primary VLAN to secondary VLAN
Private VLAN Port Type	Switch(config-if)# switchport mode private-vlan    Set private-vlan mode
Promiscuous Port Type	Switch(config-if)# switchport mode private-vlan host            Set the mode to private-vlan host promiscuous    Set the mode to private-vlan promiscuous
Host Port Type	Switch(config-if)# switchport mode private-vlan promiscuous <cr>
Private VLAN Port Configuration	Switch(config-if)# switchport mode private-vlan host
PVLAN Port Type	Switch(config-if)# switchport mode private-vlan host
Host Association	Switch(config-if)# switchport private-vlan host-association



primary to secondary  (The command is only available for host port.)	<2-4094> Primary range VLAN ID of the private VLAN port association Switch(config-if)# switchport private-vlan host-association 2 <2-4094> Secondary range VLAN ID of the private VLAN port association Switch(config-if)# switchport private-vlan host-association 2 3
Mapping primary to secondary VLANs  (This command is only available for promiscuous port)	Switch(config)# interface gi10  Switch(config-if)# switchport mode private-vlan promiscuous  Switch(config-if)# switchport private-vlan mapping 2 add 3 Switch(config-if)# switchport private-vlan mapping 2 add 4 Switch(config-if)# switchport private-vlan mapping 2 add 5
<b>Private VLAN Information</b>	
Private VLAN Information	Switch# show vlan private-vlan FLAGS: I -> Isolated P -> Promiscuous C -> Community Primary Secondary Type Ports ----- 2 3 Isolated gi10(P),gi9(I) 2 4 Community gi10(P),gi8(C) 2 5 Community gi10(P),fa7(C),gi9(I) 10 - - -
PVLAN Type	Switch# show vlan private-vlan type Vlan Type Ports ----- 2 primary gi10 3 isolated gi9 4 community gi8 5 community fa7,gi9 10 primary -
Host List	Switch# show vlan private-vlan port-list Ports Mode Vlan ----- 1 normal - 2 normal - 3 normal - 4 normal - 5 normal - 6 normal - 7 host 5 8 host 4 9 host 3 10 promiscuous 2
Running Config Information	Switch# show run Building configuration...  Current configuration: hostname Switch vlan learning independent ! vlan 1 ! Private VLAN Type vlan 2

<p>Private VLAN Port Information</p>	<pre> private-vlan primary ! vlan 3 private-vlan isolated ! vlan 4 private-vlan community ! vlan 5 private-vlan community ! ..... ..... interface fastethernet7 switchport access vlan add 2,5 switchport trunk native vlan 5 switchport mode private-vlan host switchport private-vlan host-association 2 5 ! interface gigabitethernet8 switchport access vlan add 2,4 switchport trunk native vlan 4 switchport mode private-vlan host switchport private-vlan host-association 2 4 ! interface gigabitethernet9 switchport access vlan add 2,5 switchport trunk native vlan 5 switchport mode private-vlan host switchport private-vlan host-association 2 3 ! interface gigabitethernet10 switchport access vlan add 2,5 switchport trunk native vlan 2 switchport mode private-vlan promiscuous switchport private-vlan mapping 2 add 3-5 ..... ..... </pre>
--------------------------------------	--

## 4.7 Traffic Prioritization

Quality of Service (QoS) provides traffic prioritization mechanism which allows users to deliver better service to certain flows. QoS can also help to alleviate congestion problems and ensure high-priority traffic is delivered first. This section allows you to configure Traffic Prioritization settings for each port with regard to setting priorities.

JetNet QoS supports 4 physical queues, weighted fair queuing (WRR) and Strict Priority scheme, which follows 802.1p COS tag and IPv4 TOS/DiffServ information to prioritize the traffic of your industrial network.

Following commands are included in this group:

4.7.1 QoS Setting

4.7.2 CoS-Queue Mapping

4.7.3 DSCP-Queue Mapping

4.7.4 CLI Commands of the Traffic Prioritization

### 4.7.1 QoS Setting

#### Queue Scheduling

You can select the Queue Scheduling rule as follows:

#### **Use an 8,4,2,1 weighted fair queuing scheme.**

This is also known as **WRR** (Weight Round Robin). JetNet will follow 8:4:2:1 rate to process the packets in a queue from the highest priority to the lowest. For example, the system will process 8 packets with the highest priority in the queue, 4 with middle priority, 2 with low priority, and 1 with the lowest priority at the same time.

**Use a strict priority scheme.** Packets with higher priority in the queue will always be processed first, except that there is no packet with higher priority.

#### Port Setting

**CoS** column is to indicate default port priority value for untagged or priority-tagged frames. When JetNet receives the frames, JetNet will attach the value to the CoS field of the incoming VLAN-tagged packets. You can enable 0,1,2,3,4,5,6 or 7 to the port.

**Trust Mode** is to indicate Queue Mapping types for you to select.

**COS Only:** Port priority will only follow COS-Queue Mapping you have assigned.

**DSCP Only:** Port priority will only follow DSCP-Queue Mapping you have assigned.

**COS first:** Port priority will follow COS-Queue Mapping first, and then DSCP-Queue Mapping rule.

Port	CoS	Trust Mode
1	0	COS Only
2	0	COS Only
3	0	COS Only
4	0	COS Only
5	0	COS Only
6	0	COS Only
7	0	COS Only
8	0	COS Only
9	0	COS Only
10	0	COS Only

**DSCP first:** Port priority will follow DSCP-Queue Mapping first, and then COS-Queue Mapping rule.

Default priority type is **COS Only**. The system will provide default COS-Queue table to which you can refer for the next command.

After configuration, press **Apply** to enable the settings.

#### 4.7.2 CoS-Queue Mapping

This page is to change CoS values to Physical Queue mapping table. Since the switch fabric of JetNet only supports 4 physical queues, Lowest, Low, Middle and High. Users should therefore assign how to map CoS value to the level of the physical queue.

In JetNet, users can freely assign the mapping table or follow the suggestion of the 802.1p standard. Korenix uses 802.1p suggestion as default values. You can find CoS values 1 and 2 are mapped to physical Queue 0, the lowest queue. CoS values 0 and 3 are mapped to physical Queue 1, the low/normal physical queue. CoS values 4 and 5 are mapped to physical Queue 2, the middle physical queue. CoS values 6 and 7 are mapped to physical Queue 3, the high physical queue.

### CoS-Queue Mapping

**CoS-Queue Mapping**

CoS	0	1	2	3	4	5	6	7
Queue	1 ▾	0 ▾	0 ▾	1 ▾	2 ▾	2 ▾	3 ▾	3 ▾

Note: Queue 3 is the highest priority queue.

After configuration, press **Apply** to enable the settings.

#### 4.7.3 DSCP-Queue Mapping

This page is to change DSCP values to Physical Queue mapping table. Since the switch fabric of JetNet only supports 4 physical queues, Lowest, Low, Middle and High. Users should therefore assign how to map DSCP value to the level of the physical queue. In JetNet, users can freely change the mapping table to follow the upper layer 3 switch or routers' DSCP setting.

After configuration, press **Apply** to enable the settings.

### Traffic Prioritization

**DSCP-Queue Mapping**

DSCP	0	1	2	3	4	5	6	7
Queue	1 ▾	1 ▾	1 ▾	1 ▾	1 ▾	1 ▾	1 ▾	1 ▾
DSCP	8	9	10	11	12	13	14	15
Queue	0 ▾	0 ▾	0 ▾	0 ▾	0 ▾	0 ▾	0 ▾	0 ▾
DSCP	16	17	18	19	20	21	22	23
Queue	0 ▾	0 ▾	0 ▾	0 ▾	0 ▾	0 ▾	0 ▾	0 ▾
DSCP	24	25	26	27	28	29	30	31
Queue	1 ▾	1 ▾	1 ▾	1 ▾	1 ▾	1 ▾	1 ▾	1 ▾
DSCP	32	33	34	35	36	37	38	39
Queue	2 ▾	2 ▾	2 ▾	2 ▾	2 ▾	2 ▾	2 ▾	2 ▾
DSCP	40	41	42	43	44	45	46	47
Queue	2 ▾	2 ▾	2 ▾	2 ▾	2 ▾	2 ▾	2 ▾	2 ▾
DSCP	48	49	50	51	52	53	54	55
Queue	3 ▾	3 ▾	3 ▾	3 ▾	3 ▾	3 ▾	3 ▾	3 ▾
DSCP	56	57	58	59	60	61	62	63
Queue	3 ▾	3 ▾	3 ▾	3 ▾	3 ▾	3 ▾	3 ▾	3 ▾

Note: Queue 3 is the highest priority queue.

#### 4.7.4 CLI Commands of the Traffic Prioritization

Command Lines of the Traffic Prioritization configuration

Feature	Command Line
<b>QoS Setting</b>	
Queue Scheduling – Strict Priority	Switch(config)# qos queue-sched sp Strict Priority wrr Weighted Round Robin (Use an 8,4,2,1 weight) Switch(config)# qos queue-sched sp <cr>
Queue Scheduling - WRR	Switch(config)# qos queue-sched wrr
Port Setting – CoS (Default Port Priority)	Switch(config)# interface <b>fa1</b> Switch(config-if)# qos cos DEFAULT-COS Assign an priority (7 highest) Switch(config-if)# qos cos 7 The default port CoS value is set 7 ok.  <b>Note: When change the port setting, you should Select the specific port first. Ex: fa1 means fast Ethernet port 1.</b>
Port Setting – Trust Mode- CoS Only	Switch(config)# interface fa1 Switch(config-if)# qos trust cos The port trust is set CoS only ok.
Port Setting – Trust Mode- CoS First	Switch(config)# interface fa1 Switch(config-if)# qos trust cos-first The port trust is set CoS first ok.
Port Setting – Trust Mode- DSCP Only	Switch(config)# interface fa1 Switch(config-if)# qos trust dscp The port trust is set DSCP only ok.
Port Setting – Trust Mode- DSCP First	Switch(config)# interface fa1 Switch(config-if)# qos trust dscp-first The port trust is set DSCP first ok.
Display – Queue Scheduling	Switch# show qos queue-sched QoS queue scheduling scheme : Weighted Round Robin (Use an 8,4,2,1 weight)
Display – Port Setting - Trust Mode	Switch# show qos trust QoS Port Trust Mode : Port Trust Mode -----+----- 1 DSCP first 2 COS only 3 COS only 4 COS only 5 COS only 6 COS only 7 COS only 8 COS only 9 COS only 10 COS only
Display – Port Setting – CoS (Port Default Priority)	Switch# show qos port-cos Port Default Cos : Port CoS -----+----- 1 7 2 0

	3 0 4 0 5 0 6 0 7 0 8 0 9 0 10 0
<b>CoS-Queue Mapping</b>	
Format	Switch(config)# qos cos-map PRIORITY Assign an priority (7 highest) Switch(config)# qos cos-map 1 QUEUE Assign an queue (0-3)  <b>Note: Format: qos cos-map priority_value queue_value</b>
Map CoS 0 to Queue 1	Switch(config)# qos cos-map 0 1 The CoS to queue mapping is set ok.
Map CoS 1 to Queue 0	Switch(config)# qos cos-map 1 0 The CoS to queue mapping is set ok.
Map CoS 2 to Queue 0	Switch(config)# qos cos-map 2 0 The CoS to queue mapping is set ok.
Map CoS 3 to Queue 1	Switch(config)# qos cos-map 3 1 The CoS to queue mapping is set ok.
Map CoS 4 to Queue 2	Switch(config)# qos cos-map 4 2 The CoS to queue mapping is set ok.
Map CoS 5 to Queue 2	Switch(config)# qos cos-map 5 2 The CoS to queue mapping is set ok.
Map CoS 6 to Queue 3	Switch(config)# qos cos-map 6 3 The CoS to queue mapping is set ok.
Map CoS 7 to Queue 3	Switch(config)# qos cos-map 7 3 The CoS to queue mapping is set ok.
Display – CoS-Queue mapping	Switch# sh qos cos-map CoS to Queue Mapping : CoS Queue ---- + ----- 0 1 1 0 2 0 3 1 4 2 5 2 6 3 7 3
<b>DSCP-Queue Mapping</b>	
Format	Switch(config)# qos dscp-map PRIORITY Assign an priority (63 highest) Switch(config)# qos dscp-map 0 QUEUE Assign an queue (0-3)  <b>Format: qos dscp-map priority_value queue_value</b>
Map DSCP 0 to Queue 1	Switch(config)# qos dscp-map 0 1 The TOS/DSCP to queue mapping is set ok.
Display – DSCO-Queue	Switch# show qos dscp-map DSCP to Queue Mapping : (dscp = d1 d2)

mapping	d2  0 1 2 3 4 5 6 7 8 9
	d1
	-----+
	0  1 1 1 1 1 1 1 1 0 0
	1  0 0 0 0 0 0 0 0 0 0
	2  0 0 0 0 1 1 1 1 1 1
	3  1 1 2 2 2 2 2 2 2 2
	4  2 2 2 2 2 2 2 2 3 3
	5  3 3 3 3 3 3 3 3 3 3
	6  3 3 3 3

## 4.8 Multicast Filtering

For multicast filtering, the Switch uses IGMP Snooping technology. IGMP (Internet Group Management Protocol) is an Internet Protocol that provides a way for internet device to report its multicast group membership to adjacent routers. Multicasting allows one computer on the internet to send data to a multitude of other computers that have identified themselves as being interested in receiving the originating computers data.

Multicasting is useful for such applications as updating the address books of mobile computer users in the field, sending out newsletters to a distribution list, and broadcasting streaming media to an audience that has tuned into the event by setting up multicast group membership.

In effect, IGMP Snooping manages multicast traffic by making use of switches, routers, and hosts that support IGMP. Enabling IGMP Snooping allows the ports to detect IGMP queries, report packets, and manage multicast traffic through the switch. IGMP has three fundamental types of messages, as shown below:

Message	Description
<b>Query</b>	A message sent from the querier (an IGMP router or a switch) which asks for a response from each host that belongs to the multicast group.
<b>Report</b>	A message sent by a host to the querier to indicate that the host wants to be or is a member of a given group indicated in the report message.
<b>Leave Group</b>	A message sent by a host to the querier to indicate that the host has quit as a member of a specific multicast group.

You can enable **IGMP Snooping** and **IGMP Query** functions here. You will see the information of the IGMP Snooping function in this section, including different multicast groups' VID and member ports, and IP multicast addresses that range from 224.0.0.0 to 239.255.255.255.

In this section, Force filtering can be determined whether the switch flooding unknown multicast or not.

Following commands are included in this group:

4.8.1 IGMP Snooping

4.8.2 IGMP Query

4.8.3 Force Filtering

4.8.4 CLI Commands of the Multicast Filtering

### 4.8.1 IGMP Snooping

This page is to enable IGMP Snooping feature, assign IGMP Snooping for specific VLAN, and view IGMP Snooping table from dynamic learnt or static manual key-in. JetNet5010G support IGMP snooping V1/V2/V3 automatically and IGMP query V1/V2.

**IGMP Snooping**, you can select **Enable** or **Disable** here. After enabling IGMP Snooping, you can then enable IGMP Snooping for specific VLAN. You can enable IGMP Snooping for some VLANs so that some of the VLANs will support IGMP Snooping and

	VID	IGMP Snooping
<input checked="" type="checkbox"/>	1	Enabled
<input checked="" type="checkbox"/>	2	Enabled
<input type="checkbox"/>	3	Disabled



others won't.

To assign IGMP Snooping to VLAN, please select the **checkbox** of VLAN ID or select **Select All** checkbox for all VLANs. Then press **Enable**. In the same way, you can also **Disable** IGMP Snooping for certain VLANs.

**IGMP Snooping Table:** In the table, you can see multicast group IP address, VLAN ID it belongs to, and member ports of the multicast group. The Switch supports 256 multicast groups. Click on **Reload** to refresh the table.

IP Address	VID	1	2	3	4	5	6	7	8	9	10
239.255.255.250	1	<input type="checkbox"/>	<input type="checkbox"/>	<input type="checkbox"/>	<input type="checkbox"/>	<input type="checkbox"/>	<input checked="" type="checkbox"/>	<input type="checkbox"/>	<input type="checkbox"/>	<input type="checkbox"/>	<input type="checkbox"/>
239.192.8.0	1	<input type="checkbox"/>	<input type="checkbox"/>	<input type="checkbox"/>	<input type="checkbox"/>	<input type="checkbox"/>	<input checked="" type="checkbox"/>	<input type="checkbox"/>	<input type="checkbox"/>	<input type="checkbox"/>	<input type="checkbox"/>

Reload

#### 4.8.2 IGMP Query

This page allows users to configure **IGMP Query** feature. Since the Switch can only be configured by member ports of the management VLAN, IGMP Query can only be enabled on the management VLAN. If you want to run IGMP Snooping feature in several VLANs, you should notice that whether each VLAN has its own IGMP Querier first.

**IGMP Query**

**IGMP Query on the Management VLAN**

Version	Version 1
Query Interval(s)	125
Query Maximum Response Time(s)	10

Apply

The IGMP querier periodically sends query packets to all end-stations on the LANs or VLANs that are connected to it. For networks with more than one IGMP querier, a switch with the lowest IP address becomes the IGMP querier.

In IGMP Query selection, you can select V1, V2 or Disable. **V1** means IGMP V1 General Query and **V2** means IGMP V2 General Query. The query will be forwarded to all multicast groups in the VLAN. **Disable** allows you to disable IGMP Query.

**Query Interval(s):** The period of query sent by querier.

**Query Maximum Response Time:** The span querier detect to confirm there are no more directly connected group members on a LAN.

Once you finish configuring the settings, click on **Apply** to apply your configuration.

### 4.8.3 Force Filtering



The Force filtering function allows the switch to filter the unknown-multicast data flow. If Force filtering is enabled, all the unknown multicast data will be discarded.

### 4.8.4 CLI Commands of the Multicast Filtering

Command Lines of the multicast filtering configuration

Feature	Command Line
<b>IGMP Snooping</b>	
IGMP Snooping - Global	Switch(config)# ip igmp snooping IGMP snooping is enabled globally. Please specify on which vlans IGMP snooping enables
IGMP Snooping - VLAN	Switch(config)# ip igmp snooping vlan VLANLIST allowed vlan list all all existed vlan Switch(config)# ip igmp snooping vlan 1-2 IGMP snooping is enabled on VLAN 1-2.
Disable IGMP Snooping - Global	Switch(config)# no ip igmp snoopin IGMP snooping is disabled globally ok.
Disable IGMP Snooping - VLAN	Switch(config)# no ip igmp snooping vlan 3 IGMP snooping is disabled on VLAN 3.
Display – IGMP Snooping Setting	Switch# sh ip igmp interface vlan1 enabled: Yes version: IGMPv1 query-interval; 125s query-max-response-time: 10s  Switch# sh ip igmp snooping IGMP snooping is globally enabled Vlan1 is IGMP snooping enabled Vlan2 is IGMP snooping enabled Vlan3 is IGMP snooping disabled
Display – IGMP Table	Switch# sh ip igmp snooping multicast all VLAN IP Address Type Ports ----- 1 239.192.8.0 IGMP fa6, 1 239.255.255.250 IGMP fa6,
<b>IGMP Query</b>	
IGMP Query V1	Switch(config)# int vlan 1 (Go to management VLAN) Switch(config-if)# ip igmp v1
IGMP Query V2	Switch(config)# int vlan 1 (Go to management VLAN) Switch(config-if)# ip igmp
IGMP Query version	Switch(config-if)# ip igmp version 1

	Switch(config-if)# ip igmp version 2
Disable	Switch(config)# int vlan 1 Switch(config-if)# no ip igmp
Display	Switch# sh ip igmp interface vlan1 enabled: Yes version: IGMPv2 query-interval: 125s query-max-response-time: 10s  Switch# show running-config .... ! interface vlan1 ip address 192.168.10.17/24 ip igmp no shutdown ! .....
<b>Force filtering</b>	
Enable Force filtering	Switch(config)# mac-address-table multicast filtering Filtering unknown multicast addresses ok!
Disable Force filtering	Switch(config)# no mac-address-table multicast filtering Flooding unknown multicast addresses ok!

## 4.9 SNMP

Simple Network Management Protocol (SNMP) is a protocol used for exchanging management information between network devices. SNMP is a member of the TCP/IP protocol suite. The Switch series support SNMP v1 and v2c and V3.

An SNMP managed network consists of two main components: agents and a manager. An agent is a management software module that resides in a managed switch. An agent translates the local management information from the managed device into a SNMP compatible format. The manager is the console through the network.

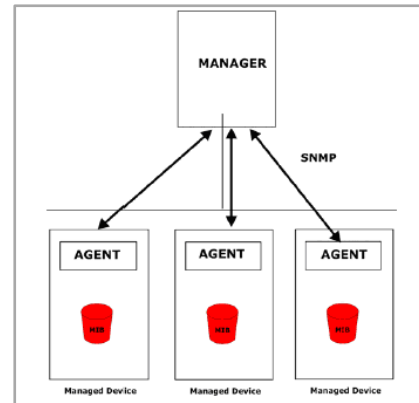

Following commands are included in this group:

### 4.9.1 SNMP Configuration

#### 4.9.2 SNMPv3 Profile

#### 4.9.3 SNMP Traps

#### 4.9.4 SNMP CLI Commands for SNMP

### 4.9.1 SNMP Configuration

This page allows users to configure SNMP V1/V2c Community. The community string can be viewed as the password because SNMP V1/V2c doesn't request you to enter password before you try to access SNMP agent.

The community includes 2 privileges, Read Only and Read and Write.

With **Read Only** privilege, you only have the ability to read the values of MIB tables. Default community string is Public.

With **Read and Write** privilege, you have the ability to read and set the values of MIB tables. Default community string is Private.

It allows users to assign 4 community strings. Type the community string and select the privilege. Then press **Apply**.

**Note:** When you first install the device in your network, we highly recommend you to change the community string. Since most SNMP management application uses Public and Private as their default community name, this might be the leakage of the network security.

**SNMP**

**SNMP V1/V2c Community**

Community String	Privilege
public	Read Only ▼
private	Read and Write ▼
	Read Only ▼
	Read Only ▼

**Apply**

### 4.9.2 SNMP V3 Profile

SNMP v3 can provide more security functions when the user performs remote management through SNMP protocol. It delivers SNMP information to the administrator with user

**SNMP V3 Profile**

**SNMP V3**

User Name	<input type="text"/>
Security Level	Authentication ▼
Authentication Portocol	SHA ▼
Authentication Password	<input type="password"/>
DES Encryption Password	<input type="password"/>

**Add**

authentication; all of data between the *Switch* and the administrator are encrypted to ensure secure communication.

**Security Level:** Here the user can select the following levels of security: None, User Authentication, and Authentication with privacy.

**Authentication Protocol:** Here the user can select either MD5 (Message-Digest algorithm 5) or SHA (Secure Hash Algorithm). MD5 is a widely used cryptographic hash function with a 128-bit hash value. SHA (Secure Hash Algorithm) hash functions refer to five Federal Information Processing Standard-approved algorithms for computing a condensed digital representation. The Switch provides 2 user authentication protocols in MD5 and SHA. You will need to configure SNMP v3 parameters for your SNMP tool with the same authentication method.

**Authentication Password:** Here the user enters the SNMP v3 user authentication password.

**DES Encryption Password:** Here the user enters the password for SNMP v3 user DES Encryption.

#### 4.9.3 SNMP Traps

SNMP Trap is the notification feature defined by SNMP protocol. All the SNMP management applications can understand such trap information. So you don't need to install new application to read the notification information.

This page allows users to **Enable SNMP Trap**, configure the **SNMP Trap server IP**, **Community** name, and trap **Version V1 or V2**. After configuration, you can see the change of the SNMP pre-defined standard traps and Korenix pre-defined traps. The pre-defined traps can be found in Korenix private MIB.

#### 4.9.4 CLI Commands of the SNMP

Command Lines of the SNMP configuration

Feature	Command Line
<b>SNMP Community</b>	
Read Only Community	Switch(config)# snmp-server community public ro community string add ok
Read Write Community	Switch(config)# snmp-server community private rw community string add ok

SNMP Trap	
Enable Trap	Switch(config)# snmp-server enable trap Set SNMP trap enable ok.
SNMP Trap Server IP without specific community name	Switch(config)# snmp-server host 192.168.10.33 SNMP trap host add OK.
SNMP Trap Server IP with version 1 and community	Switch(config)# snmp-server host 192.168.10.33 version 1 private SNMP trap host add OK. <b>Note: private is the community name, version 1 is the SNMP version</b>
SNMP Trap Server IP with version 2 and community	Switch(config)# snmp-server host 192.168.10.33 version 2 private SNMP trap host add OK.
Disable SNMP Trap	Switch(config)# no snmp-server enable trap Set SNMP trap disable ok.
Display	Switch# sh snmp-server trap SNMP trap: Enabled SNMP trap community: public  Switch# show running-config ..... snmp-server community public ro snmp-server community private rw snmp-server enable trap snmp-server host 192.168.10.33 version 2 admin snmp-server host 192.168.10.33 version 1 admin .....

## 4.10 Security

The Switch provides several security features for you to secure your connection. The features include Port Security and IP Security.

Following commands are included in this group:

4.10.1 Port Security

4.10.2 IP Security

4.10.3 IEEE 802.1x

4.10.4 CLI Commands of the Security

### 4.10.1 Port Security

Port Security feature allows you to stop the MAC address learning for specific port. After stopping MAC learning, only the MAC address listed in Port Security List can access the switch and transmit/receive traffic. This is a simple way to secure your network environment and not to be accessed by hackers.

This page allows you to enable Port Security and configure Port Security entry.

**Port Security State:** Change Port Security State of the port to Enable first.

**Add Port Security Entry:** Select the port, and type VID and MAC address. Format of the MAC address is xxxx.xxxx.xxxx. Ex: 0012.7701.0101. Max volume of one port is 10. So the system can accept 100 Port Security MAC addresses in total.

**Port Security List:** This table shows you those enabled port security entries. You can click on **Remove** to delete the entry.

Once you finish configuring the settings, click on **Apply / Add** to apply your configuration.

**Port Security**

**Port Security State**

Port	State
1	Disable
2	Disable
3	Disable
4	Disable
5	Disable
6	Disable
7	Disable
8	Disable
9	Disable
10	Disable

**Add Port Security Entry**

Port	VID	MAC Address
Port 7	1	0012.7710.0102

**Port Security List**

Port	VID	MAC Address
7	1	0012.7710.0101
7	1	0012.7710.0102

### 4.10.2 IP Security

In IP Security section, you can set up specific IP addresses to grant authorization for management access to this JetNet via a web browser or Telnet.

**IP Security:** Select Enable and **Apply** to enable IP security function.

**Add Security IP:** You can assign specific IP addresses, and then press **Add**. Only these IP addresses can access and manage JetNet via a web browser or Telnet. Max security IP is 10.

**Security IP List:** This table shows you added security IP addresses. You can press **Remove** to delete,

**IP Security**

**IP Security** Enable

**Add Security IP**

Security IP
192.168.10.33

**Security IP List**

Index	Security IP
1	192.168.10.33

**Reload** to reload the table.

Once you finish configuring the settings, click on **Apply** to apply your configuration.

### 4.10.3 IEEE 802.1x

#### 4.10.3.1 802.1X configuration

IEEE 802.1X is the protocol that performing authentication to obtain access to IEEE 802 LANs. It is port-base network access control. With the function, the Switch could control which connection is available or not.

**802.1x Port-Based Network Access Control Configuration**

**System Auth Control** Disable ▼

**Authentication Method** Radius ▼

Apply

**Radius Server**

RADIUS Server IP	192.168.10.100
Shared Key	radius-key
Server Port	1812
Accounting Port	1813

**Local Radius User**

Username	Password	VID

Add

**Secondary Radius Server**

RADIUS Server IP	
Shared Key	
Server Port	
Accounting Port	

Apply

**Local Radius User List**

Username	Password	VID
----------	----------	-----

Remove

**System AuthControl:** To enable or disable the 802.1x authentication.

**Authentication Method:** Radius is a authentication server that provide key for authentication, with this method, user must connect switch to server. If user select Local for the authentication method, switch use the local user data base which can be create in this page for authentication.

**Radius Server IP:** The IP address of Radius server

**Shared Key:** The password for communicate between switch and Radius Server.

**Server Port:** UDP port of Radius server.

**Accounting Port:** Port for packets that contain the information of account login or logout.

**Secondary Radius Server IP:** Secondary Radius Server could be set in case of the primary radius server down.

**802.1X Local User:** Here User can add Account/Password for local authentication.

**802.1X Local user List:** This is a list shows the account information, User also can remove selected account Here.



#### 4.10.3.2 802.1x Port Configuration

After the configuration of Radius Server or Local user list, user also need configure the authentication mode, authentication behavior, applied VLAN for each port and permitted communication. The following information will explain the port configuration.

#### 802.1x Port-Based Network Access Control Port Configuration

802.1x Port Configuration

Port	Port Control	Reauthentication	Max Request	Guest VLAN	Host Mode	Admin Control Direction
1	Force Authorized	Disable	2	0	Single	Both
2	Force Authorized	Disable	2	0	Single	Both
3	Force Authorized	Disable	2	0	Single	Both
4	Force Authorized	Disable	2	0	Single	Both
5	Force Authorized	Disable	2	0	Single	Both
6	Force Authorized	Disable	2	0	Single	Both

802.1x Timeout Configuration

Port	Re-Auth Period(s)	Quiet Period(s)	Tx Period(s)	Supplicant Timeout(s)	Server Timeout(s)
1	3600	60	30	30	30
2	3600	60	30	30	30
3	3600	60	30	30	30
4	3600	60	30	30	30
5	3600	60	30	30	30
6	3600	60	30	30	30

**Port control:** Force Authorized means this port is authorized; the data is free to in/out. Force unauthorized just opposite, the port is blocked. If users want to control this port with Radius Server, please select Auto for port control.

**Reauthentication:** If enable this field, switch will ask client to re-authenticate. The default time interval is 3600 seconds.

**Max Request:** the maximum times that the switch allow client request.

**Guest VLAN:** 0 to 4094 is available for this field. If this field is set to 0, that means the port is blocked after authentication fail. Otherwise, the port will be set to Guest VLAN.

**Host Mode:** if there are more than one device connected to this port, set the Host Mode to single means only the first PC authenticate success can access this port. If this port is set to multi, all the device can access this port once any one of them pass the authentication.

**Control Direction:** determined devices can end data out only or both send and receive.

**Re-Auth Period:** control the Re-authentication time interval, 1~65535 is available.

**Quiet Period:** When authentication failed, Switch will wait for a period and try to communicate with radius server again.

**Tx period:** the time interval of authentication request.

**Supplicant Timeout:** the timeout for the client authenticating

**Sever Timeout:** The timeout for server response for authenticating.

Once you finish configuring the settings, click on **Apply** to apply your configuration.

Click **Initialize Selected** to set the authorize state of selected port to initialize status.

Click **Reauthenticate Selected** to send EAP Request to supplicant to request reauthentication.

Click **Default Selected** to reset the configurable 802.1x parameters of selected port to the default values.

#### 4.10.3.3 802.1X Port Status

Here user can observe the port status for Port control status, Authorize Status, Authorized Supplicant and Oper Control Direction each port.

Port	Port Control	Authorize Status	Authorized Supplicant	Oper Control Direction
1	Force Authorized	AUTHORIZED	NONE	Both
2	Force Authorized	AUTHORIZED	NONE	Both
3	Force Authorized	AUTHORIZED	NONE	Both
4	Force Authorized	AUTHORIZED	NONE	Both
5	Force Authorized	AUTHORIZED	NONE	Both
6	Force Authorized	AUTHORIZED	NONE	Both
7	Force Authorized	AUTHORIZED	NONE	Both

Reload

#### 4.10.4 CLI Commands of the Security

Command Lines of the Security configuration

Feature	Command Line
<b>Http / Telnet Security (only available for command line interface)</b>	
Telnet service security	Switch# show service ; show current service status System service Telnet : Enabled Http : Enabled Switch(config)# service telnet ; it is recommended operating via local console interface only. disable Disable telnet service ; stop service request from TCP port #23. enable Enable telnet service; enable service request from TCP #23 Switch(config)# service telnet enable Switch(config)# service telnet disable
Http service security	Switch(config)# service http; available operating via telnet or local console interface. Switch(config)# service http disable ; disable TCP port #80 service. Switch(config)# service http enable; enable TCP port #80 service.

Port Security	
Add MAC	Switch(config)# mac-address-table static 0012.7701.0101 vlan 1 interface fa1 mac-address-table unicast static set ok!
Port Security	Switch(config)# interface fa1 Switch(config-if)# switchport port-security Disables new MAC addresses learning and aging activities!  <b>Note: Rule: Add the static MAC, VLAN and Port binding first, then enable the port security to stop new MAC learning.</b>
Disable Port Security	Switch(config-if)# no switchport port-security Enable new MAC addresses learning and aging activities!
Display	Switch# show mac-address-table static Destination Address    Address Type        Vlan Destination Port ----- 0012.7701.0101        Static                1        fa1
IP Security	
IP Security	Switch(config)# ip security Set ip security enable ok. Switch(config)# ip security host 192.168.10.33 Add ip security host 192.168.10.33 ok.
Display	Switch# show ip security ip security is enabled ip security host: 192.168.10.33
802.1x	
enable	Switch(config)# dot1x system-auth-control
disable	Switch(config)# Switch(config)# no dot1x system-auth-control Switch(config)#
authentic-method	Switch(config)# dot1x authentic-method local    Use the local username database for authentication radius    Use the Remote Authentication Dial-In User Service (RADIUS) servers for authentication Switch(config)# dot1x authentic-method radius Switch(config)#
radius server-ip	Switch(config)# dot1x radius Switch(config)# dot1x radius server-ip 192.168.10.120 key 1234  RADIUS Server Port number NOT given. (default=1812) RADIUS Accounting Port number NOT given. (default=1813) RADIUS Server IP    : 192.168.10.120 RADIUS Server Key    : 1234 RADIUS Server Port   : 1812 RADIUS Accounting Port : 1813 Switch(config)#
radius server-ip	Switch(config)# dot1x radius Switch(config)# dot1x radius server-ip 192.168.10.120 key 1234  RADIUS Server Port number NOT given. (default=1812) RADIUS Accounting Port number NOT given. (default=1813) RADIUS Server IP    : 192.168.10.120

	RADIUS Server Key : 1234 RADIUS Server Port : 1812 RADIUS Accounting Port : 1813 Switch(config)#
radius secondary-server-ip	Switch(config)# dot1x radius secondary-server-ip 192.168.10.250 key 5678  Port number NOT given. (default=1812) RADIUS Accounting Port number NOT given. (default=1813) Secondary RADIUS Server IP : 192.168.10.250 Secondary RADIUS Server Key : 5678 Secondary RADIUS Server Port : 1812 Secondary RADIUS Accounting Port : 1813
User name/password for authentication	Switch(config)# dot1x username korenix passwd korenix vlan 1

## 4.11 Warning

The Switch provides several types of Warning features for you to remote monitor the status of end devices or the change of your network. The features include Fault Relay, System Log and SMTP E-mail Alert.

Following commands are included in this group:

- 4.11.1 Fault Relay
- 4.11.2 Event Selection
- 4.11.3 Syslog Configuration
- 4.11.4 SMTP Configuration
- 4.11.5 CLI Commands

### 4.11.1 Fault Relay

The Switch provides 2 digital outputs, also known as Relay Output or Fault Relay. The relay contacts are energized (open) for normal operation and will close when fault event occurred. The fault event types includes Power, Port Link down, Ring failure, DI event, specified IP address ping failure, DI State change or perform a period of on/off.

Each Fault Relay could be trigger by several of events, not only one. The function is available from firmware version 2.8.

Fault Relay	
<b>Relay 1</b>	Status is Off
<input type="checkbox"/> Power	Power ID <input type="text" value="Power DC1"/> ▼
<input type="checkbox"/> Port Link	Port <input type="checkbox"/> 1 <input type="checkbox"/> 2 <input type="checkbox"/> 3 <input type="checkbox"/> 4 <input type="checkbox"/> 5 <input type="checkbox"/> 6 <input type="checkbox"/> 7 <input type="checkbox"/> 8 <input type="checkbox"/> 9 <input type="checkbox"/> 10
<input type="checkbox"/> Ring	Ring Failure
<input type="checkbox"/> Ping	IP Address <input type="text"/>
<input type="checkbox"/> Ping Reset	IP Address <input type="text"/> Reset Time(Sec) <input type="text"/> Hold Time(Sec) <input type="text"/>
<input type="checkbox"/> Dry Output	On Period(Sec) <input type="text"/> Off Period(Sec) <input type="text"/>
<input type="checkbox"/> DI	DI Number <input type="text" value="DI 1"/> ▼ DI State <input type="text" value="High"/> ▼
<b>Relay 2</b>	Status is Off
<input type="checkbox"/> Power	Power ID <input type="text" value="Power DC1"/> ▼
<input type="checkbox"/> Port Link	Port <input type="checkbox"/> 1 <input type="checkbox"/> 2 <input type="checkbox"/> 3 <input type="checkbox"/> 4 <input type="checkbox"/> 5 <input type="checkbox"/> 6 <input type="checkbox"/> 7 <input type="checkbox"/> 8 <input type="checkbox"/> 9 <input type="checkbox"/> 10
<input type="checkbox"/> Ring	Ring Failure
<input type="checkbox"/> Ping	IP Address <input type="text"/>
<input type="checkbox"/> Ping Reset	IP Address <input type="text"/> Reset Time(Sec) <input type="text"/> Hold Time(Sec) <input type="text"/>
<input type="checkbox"/> Dry Output	On Period(Sec) <input type="text"/> Off Period(Sec) <input type="text"/>
<input type="checkbox"/> DI	DI Number <input type="text" value="DI 1"/> ▼ DI State <input type="text" value="High"/> ▼

#### DI:

DI Number: Select DI 1 or DI 2. Select which DI you want to monitor.

DI State: High or Low. Select the power voltage you want to monitor.

How to configure: Select the DI Number you want to monitor and DI State, High or Low. For example: When DI 1 and High are selected, it means when DI 1 is pulled high, the system will short Relay Output and light DO LED.

**Dry Output:**

On Period (Sec): Type the period time to turn on Relay Output. Available range of a period is 0-4294967295 seconds.

Off Period (Sec): Type the period time to turn off Relay Output. Available range of a period is 0-4294967295 seconds.

**Ping Failure:**

**IP Address:** IP address of the target device you want to ping.

**Reset Time (Sec):** Waiting time to short the relay output.

**Hold Time (Sec):** Waiting time to ping the target device for the duration of remote device boot

How to configure: After selecting Ping Failure event type, the system will turn Relay Output to short state and continuously ping the target device. When the ping failure occurred, the switch will turn the Relay Output to open state for a period of Reset Time.

After the Reset Time timeout, the system will turn the Relay Output to close state. After the Hold Time timer is timeout, the switch system will start ping the target device.

Ex: Reset Time is 5 sec, Hold Time is 50 sec.

If the ping failure occurred, the switch system will turn Relay output to open state to emulate power switch off for 5 sec periods. After Reset Time timeout, the Switch system will start ping target device after 50 sec periods. The period time is for target device system booting. During the period, the switch system will not ping target device until Hold Time is timeout.

**Ring:**

Select Super Ring Failure. When the Rapid Super Ring topology is changed, the system will short Relay Out and lengthen DO LED.

Once you finish configuring the settings, click on **Apply** to apply your configuration.

**4.11.2 Event Selection**

Event Types can be divided into two basic groups: System Events and Port Events. System Events are related to the overall function of the switch, whereas Port Events related to the activity of specific ports

System Event	Warning Event is sent when.....
Device Cold Start	Power is cut off and then reconnected.
Device Warm Start	Reboot the device by CLI or Web UI.
Power 1 Failure	Power 1 is failure.
Power 2 Failure	Power 2 is failure.
Authentication failure	An incorrect password, SNMP Community String is entered.
Time Synchronize Failure	Accessing to NTP Server is failure.
Fault Relay	The DO/Fault Relay is on.

Ring Event	Master of Super Ring has changed or backup path is activated.
DI1 Change	The Digital Input#1 status is changed.
DI2 Change	The Digital Input#2 status is changed.
SFP DDM Failure	The readed information of DDM SFP transceiver is over temperature or out the range of TX/RX power.
Loop Protection	Port Looping is detected.
<b>Port Event</b>	<b>Warning Event is sent when.....</b>
Link-Up	The port is connected to another device
Link-Down	The port is disconnected (e.g. the cable is pulled out, or the opposing devices turns down)
Both	The link status changed.

### Warning - Event Selection

**System Event Selection**

Device Cold Start       Device Warm Start  
 Power1 Failure       Power2 Failure  
 Authentication Failure       Time Synchronize Failure  
 Fault Relay       Ring Event  
 SFP Failure       DI1 Change       DI2 Change  
 Loop Protection

**Port Event Selection**

Port	Link State
1	Disable ▼
2	Disable ▼
3	Disable ▼
4	Disable ▼
5	Disable ▼
6	Disable ▼
7	Disable ▼
8	Disable ▼
9	Disable ▼
10	Disable ▼

Once you finish configuring the settings, click on **Apply** to apply your configuration.

#### 4.11.3 SysLog Configuration

System Log is useful to provide system administrator locally or remotely monitor switch events history. There are 2 System Log modes provided by the system, local mode and remote mode.

**Local Mode:** In this mode, the Switch will print the occurred events selected in the Event Selection page to System Log table of the Switch. You can monitor the system logs in [Monitor and Diag] / [Event Log] page.

**Remote Mode:** The remote mode is also known as Server mode. In this mode, you should assign the IP address of the System Log server. The Switch will send the occurred events selected in Event Selection page to System Log server you assigned.

**Both:** Above 2 modes can be enabled at the same time.

**Warning - SysLog Configuration**

Syslog Mode: Both

Remote IP Address: Local

Note: When enabled Local or Remote modes, you can monitor the system logs in the [Monitor and Diag] / [Event Log] page.

Apply

Once you finish configuring the settings, click on **Apply** to apply your configuration.

**Note:** When enabling Local or Both modes, you can monitor the system logs in [Monitor and Diag] / [Event Log] page.

#### 4.11.4 SMTP Configuration

The Switch supports E-mail Warning feature. The switch will send the occurred events to remote E-mail server. The receiver can then receive notification by E-mail. The E-mail warning is conformed to SMTP standard.

This page allows you to enable E-mail Alert, assign the SMTP Server IP, Sender E-mail, and Receiver E-mail. If SMTP server requests you to authorize first, you can also set up the username and password in this page.

**Warning - SMTP Configuration**

E-mail Alert: Enable

**SMTP Configuration**

SMTP Server IP: 192.168.10.1

Mail Account: admin@korenix.com

Authentication

User Name: [ ]

Password: [ ]

Confirm Password: [ ]

Rcpt E-mail Address 1: korecare@korenix.com

Rcpt E-mail Address 2: [ ]

Rcpt E-mail Address 3: [ ]

Rcpt E-mail Address 4: [ ]

Apply

Field	Description
SMTP Server IP Address	Enter the IP address of the email Server
Authentication	Click on check box to enable password
User Name	Enter email Account name (Max.40 characters)
Password	Enter the password of the email account
Confirm Password	Re-type the password of the email account
You can set up to 4 email addresses to receive email alarm from JetNet	



Rcpt E-mail Address 1	The first email address to receive email alert from JetNet (Max. 40 characters)
Rcpt E-mail Address 2	The second email address to receive email alert from JetNet (Max. 40 characters)
Rcpt E-mail Address 3	The third email address to receive email alert from JetNet (Max. 40 characters)
Rcpt E-mail Address 4	The fourth email address to receive email alert from JetNet (Max. 40 characters)

Once you finish configuring the settings, click on **Apply** to apply your configuration.

#### 4.11.5 CLI Commands

Command Lines of the Warning configuration

Feature	Command Line
<b>Relay Output</b>	
Relay Output	Switch(config)# relay 1 di DI state dry dry output ping ping failure port port link failure power power failure ring super ring failure  <b>Note: Select Relay 1 or 2 first, then select the event types.</b>
DI State	Switch(config)# relay 1 di <1-2> DI number Switch(config)# relay 1 di 1 high high is abnormal low low is abnormal Switch(config)# relay 1 di 1 high
Dry Output	Switch(config)# relay 1 dry <0-4294967295> turn on period in second Switch(config)# relay 1 dry 5 <0-4294967295> turn off period in second Switch(config)# relay 1 dry 5 5
Ping Failure	Switch(config)# relay 1 ping 192.168.10.33 <cr> reset reset a device Switch(config)# relay 1 ping 192.168.10.33 reset <1-65535> reset time Switch(config)# relay 1 ping 192.168.10.33 reset 60 <0-65535> hold time to retry Switch(config)# relay 1 ping 192.168.10.33 reset 60 60
Port Link Failure	Switch(config)# relay 1 port PORTLIST port list

	Switch(config)# relay 1 port fa1-5
Power Failure	Switch(config)# relay 1 power <1-2> power id Switch(config)# relay 1 power 1 Switch(config)# relay 1 power 2
Super Ring Failure	Switch(config)# relay 1 ring
Disable Relay	Switch(config)# no relay <1-2> relay id Switch(config)# no relay 1 (Relay_ID: 1 or 2) <cr>
Display	Switch# show relay 1 Relay Output Type : Port Link Port : 1, 2, 3, 4, Switch# show relay 2 Relay Output Type : Super Ring
<b>Event Selection</b>	
Event Selection	Switch(config)# warning-event coldstart Switch cold start event warmstart Switch warm start event linkdown Switch link down event linkup Switch link up event authentication Authentication failure event di Switch di event fault-relay Switch fault relay event loop-protect Switch loop protection event power Switch power failure event ring Switch ring event sfp Switch SFP event time-sync Switch time synchronize event
Ex: Cold Start event	Switch(config)# warning-event coldstart Set cold start event enable ok.
Ex: Link Up event	Switch(config)# warning-event linkup [IFNAME] Interface name, ex: fastethernet1 or gi8 Switch(config)# warning-event linkup fa5 Set fa5 link up event enable ok.
Display	Switch# show warning-event Cold Start: Disabled Warm Start: Disabled Authentication Failure: Disabled Link Down: Link Up: Power Failure: Disabled Ring: Disabled Fault Relay: Disabled Time Synchronize Failure: Disabled SFP: Disabled DI: Disabled Loop Protection: Enabled
<b>Syslog Configuration</b>	
Local Mode	Switch(config)# log syslog local
Server Mode	Switch(config)# log syslog remote 192.168.10.33
Both	Switch(config)# log syslog local Switch(config)# log syslog remote 192.168.10.33
Disable	Switch(config)# no log syslog local

SMTP Configuration	
SMTP Enable	Switch(config)# smtp-server enable email-alert SMTP Email Alert set enable ok.
Sender mail	Switch(config)# smtp-server server 192.168.10.100 ACCOUNT SMTP server mail account, ex: admin@korenix.com Switch(config)# smtp-server server 192.168.10.100 admin@korenix.com SMTP Email Alert set Server: 192.168.10.100, Account: admin@korenix.com ok.
Receiver mail	Switch(config)# smtp-server receipt 1 korecare@korenix.com SMTP Email Alert set receipt 1: korecare@korenix.com ok.
Authentication with username and password	Switch(config)# smtp-server authentication username admin password admin SMTP Email Alert set authentication Username: admin, Password: admin  <b>Note: You can assign string to username and password.</b>
Disable SMTP	Switch(config)# no smtp-server enable email-alert SMTP Email Alert set disable ok.
Disable Authentication	Switch(config)# no smtp-server authentication SMTP Email Alert set Authentication disable ok.
Display	Switch# sh smtp-server SMTP Email Alert is Enabled Server: 192.168.10.100, Account: admin@korenix.com Authentication: Enabled Username: admin, Password: admin SMTP Email Alert Receipt: Receipt 1: korecare@korenix.com Receipt 2: Receipt 3: Receipt 4:

## 4.12 Monitor and Diag

The Switch provides several types of features for you to monitor the status of the switch or diagnostic for you to check the problem when encountering problems related to the switch. The features include MAC Address Table, Port Statistics, Port Mirror, Event Log and Ping.

Following commands are included in this group:

4.12.1 MAC Address Table

4.12.2 Port Statistics

4.12.3 Port Mirror

4.12.4 Event Log

4.12.5 Topology Discovery

4.12.5 Ping

4.12.6 CLI Commands of the Monitor and Diag

### 4.12.1 MAC Address Table

The Switch provides 8K entries in MAC Address Table. In this page, users can change the Aging time, add Static Unicast MAC Address, monitor the MAC address or sort them by different packet types and ports. Click on **Apply** to change the value.

#### Aging Time (Sec)

Each switch fabric has limit size to write the learnt MAC address. To save more entries for new MAC address, the switch fabric will age out non-used MAC address entry per Aging Time timeout. The default Aging Time is 300 seconds. The Aging Time can be modified in this page.

#### Static Unicast MAC Address

In some applications, users may need to type in the static Unicast MAC address to its MAC address table. In this page, you can type MAC Address (format: xxxx.xxxx.xxxx), select its VID and Port ID, and then click on **Add** to add it to MAC Address table.

#### MAC Address Table

In this MAC Address Table, you can see all the MAC Addresses learnt by the switch fabric. The packet types include Management Unicast, Static Unicast, Dynamic Unicast, Static Multicast and Dynamic Multicast. The table allows users to sort the address by the packet types and port.

**Packet Types:** **Management Unicast** means MAC address of the switch. It belongs to CPU port only. **Static Unicast** MAC address can be added and deleted. **Dynamic Unicast** MAC is MAC address learnt by the switch Fabric. **Static Multicast** can be added by CLI and can be deleted by Web and CLI. **Dynamic Multicast** will appear after you enabled IGMP and the switch learnt IGMP report.

Click on **Remove** to remove the static Unicast/Multicast MAC address. Click on **Reload** to refresh the table. New learnt Unicast/Multicast MAC address will be updated to MAC address table.

### MAC Address Table

**Aging Time (Sec)**

**Apply**

**Static Unicast MAC Address**

MAC Address	VID	Port
<input type="text"/>	<input type="text"/>	Port 1

**Add**

**MAC Address Table**

MAC Address	Address Type	VID	1	2	3	4	5	6	7	8	9	10
000f.b079.ca3b	Dynamic Unicast	1	<input type="checkbox"/>	<input type="checkbox"/>	<input type="checkbox"/>	<input checked="" type="checkbox"/>	<input type="checkbox"/>	<input type="checkbox"/>	<input type="checkbox"/>	<input type="checkbox"/>	<input type="checkbox"/>	<input type="checkbox"/>
0012.7701.0386	Dynamic Unicast	1	<input type="checkbox"/>	<input type="checkbox"/>	<input type="checkbox"/>	<input type="checkbox"/>	<input type="checkbox"/>	<input type="checkbox"/>	<input checked="" type="checkbox"/>	<input type="checkbox"/>	<input type="checkbox"/>	<input type="checkbox"/>
0012.7710.0101	Static Unicast	1	<input type="checkbox"/>	<input type="checkbox"/>	<input type="checkbox"/>	<input type="checkbox"/>	<input type="checkbox"/>	<input type="checkbox"/>	<input checked="" type="checkbox"/>	<input type="checkbox"/>	<input type="checkbox"/>	<input type="checkbox"/>
0012.7710.0102	Static Unicast	1	<input type="checkbox"/>	<input type="checkbox"/>	<input type="checkbox"/>	<input type="checkbox"/>	<input type="checkbox"/>	<input type="checkbox"/>	<input checked="" type="checkbox"/>	<input type="checkbox"/>	<input type="checkbox"/>	<input type="checkbox"/>
0012.77ff.0100	Management Unicast	1	<input type="checkbox"/>	<input type="checkbox"/>	<input type="checkbox"/>	<input type="checkbox"/>	<input type="checkbox"/>	<input type="checkbox"/>	<input type="checkbox"/>	<input type="checkbox"/>	<input type="checkbox"/>	<input type="checkbox"/>
0100.5e40.0800	fa6 Multicast	1	<input type="checkbox"/>	<input type="checkbox"/>	<input type="checkbox"/>	<input type="checkbox"/>	<input type="checkbox"/>	<input type="checkbox"/>	<input type="checkbox"/>	<input type="checkbox"/>	<input type="checkbox"/>	<input type="checkbox"/>
0100.5e7f.ffa	fa4,fa6 Multicast	1	<input type="checkbox"/>	<input type="checkbox"/>	<input type="checkbox"/>	<input type="checkbox"/>	<input type="checkbox"/>	<input type="checkbox"/>	<input type="checkbox"/>	<input type="checkbox"/>	<input type="checkbox"/>	<input type="checkbox"/>

**Remove** **Reload**

#### 4.12.2 Port Statistics

In this page, you can view operation statistics for each port. The statistics that can be viewed include Link Type, Link State, Rx Good, Rx Bad, Rx Abort, Tx Good, Tx Bad and Collision. Rx means the received packet while Tx means the transmitted packets.

*Note: If you see many Bad, Abort or Collision counts increased, that may mean your network cable is not connected well, the network performance of the port is poor...etc. Please check your network cable, Network Interface Card of the connected device, the network application, or reallocate the network traffic...etc.*

Click on **Clear Selected** to reinitialize the counts of the selected ports, and **Clear All** to reinitialize the counts of all ports. Click on **Reload** to refresh the counts.

### Port Statistics

Port	Type	Link	State	Rx Good	Rx Bad	Rx Abort	Tx Good	Tx Bad	Collision
1	100TX	Down	Enable	0	0	0	0	0	0
2	100TX	Down	Enable	10	0	0	11	0	0
3	100TX	Down	Enable	0	0	0	0	0	0
4	100TX	Up	Enable	2131	0	0	2452	0	0
5	100TX	Down	Enable	0	0	0	0	0	0
6	100TX	Down	Enable	4884	1	2	5919	0	0
7	100TX	Up	Enable	54	0	0	2742	0	0
8	1000TX	Down	Enable	0	0	0	0	0	0
9	1000TX	Down	Enable	0	0	0	0	0	0
10	1000TX	Down	Enable	0	0	0	0	0	0

**Clear Selected** **Clear All** **Reload**

### 4.12.3 Port Mirroring

Port mirroring (also called port spanning) is a tool that allows you to mirror the traffic from one or more ports onto another port, without disrupting the flow of traffic on the original port. Any traffic that goes into or out of the Source Port(s) will be duplicated at the Destination Port. This traffic can then be analyzed at the Destination port using a monitoring device or application. A network administrator will typically utilize this tool for diagnostics, debugging, or fending off attacks.

**Port Mirror Mode:** Select Enable/Disable to enable/disable Port Mirror.

**Source Port:** This is also known as Monitor Port. These are the ports you want to monitor. The traffic of all source/monitor ports will be copied to destination/analysis ports. You can choose a single port, or any combination of ports, but you can only monitor them in Rx or TX only. Click on checkbox of the Port ID, RX, Tx or Both to select the source ports.

**Destination Port:** This is also known as Analysis Port. You can analyze the traffic of all the monitored ports at this port without affecting the flow of traffic on the port(s) being monitored. Only one RX/TX of the destination port can be selected. A network administrator would typically connect a LAN analyzer or Netxray device to this port.

Once you finish configuring the settings, click on **Apply** to apply the settings.

**Port Mirroring**

**Port Mirror Mode**

**Port Selection**

Port	Source Port		Destination Port	
	Rx	Tx	Rx	Tx
1	<input checked="" type="checkbox"/>	<input checked="" type="checkbox"/>	<input type="radio"/>	<input type="radio"/>
2	<input checked="" type="checkbox"/>	<input checked="" type="checkbox"/>	<input type="radio"/>	<input type="radio"/>
3	<input type="checkbox"/>	<input type="checkbox"/>	<input checked="" type="radio"/>	<input type="radio"/>
4	<input type="checkbox"/>	<input type="checkbox"/>	<input type="radio"/>	<input checked="" type="radio"/>
5	<input type="checkbox"/>	<input type="checkbox"/>	<input type="radio"/>	<input type="radio"/>
6	<input type="checkbox"/>	<input type="checkbox"/>	<input type="radio"/>	<input type="radio"/>
7	<input type="checkbox"/>	<input type="checkbox"/>	<input type="radio"/>	<input type="radio"/>
8	<input type="checkbox"/>	<input type="checkbox"/>	<input type="radio"/>	<input type="radio"/>
9	<input type="checkbox"/>	<input type="checkbox"/>	<input type="radio"/>	<input type="radio"/>
10	<input type="checkbox"/>	<input type="checkbox"/>	<input type="radio"/>	<input type="radio"/>

### 4.12.4 Event Log

In the 4.10.3, we have introduced System Log feature. When System Log Local mode is selected, the Switch will record occurred events in local log table. This page shows this log table. The entry includes the index, occurred data and time and content of the events.

Click on **Clear** to clear the entries. Click on **Reload** to refresh the table.

**System Event Logs**

Index	Date	Time	Event Log
1	Jan 1	02:50:53	Event: Link 4 Up.
2	Jan 1	02:50:51	Event: Link 5 Down.
3	Jan 1	02:50:50	Event: Link 5 Up.
4	Jan 1	02:50:47	Event: Link 4 Down.

### 4.12.5 Topology Discovery

JetNet 4510 supports topology discovery or LLDP (IEEE 802.1AB Link Layer Discovery Protocol) function that can help user to discovery multi-vendor's network devicec on same segment by NMS system which supports LLDP function; With LLDP function, NMS can

easier maintain the topology map, display port ID, port description, system description, VLAN ID... Once the link failure, the topology change events can be updated to the NMS as well. The LLDP Port State can display the neighbor ID and IP learnt from the connected devices.

**LLDP:** Select Enable/Disable to enable/disable LLDP function.

**LLDP Configuration:** To configure the related timer of LLDP.

**LLDP Timer:** the interval time of each LLDP and counts in second; the valid number is from 5 to 254, default is 30 seconds.

**LLDP Hold time:** The TTL (Time To Live) timer. The LLDP state will be expired once the LLDP is not received by the hold time. The default is 120 seconds.

**Local port:** the current port number that linked with neighbor network device.

**Neighbor ID:** the MAC address of neighbor device on the same network segment.

**Neighbor IP:** the IP address of neighbor device on the same network segment.

**Neighbor VID:** the VLAN ID of neighbor device on the same network segment.

#### 4.12.6 Ping Utility

This page provides **Ping Utility** for users to ping remote device and check whether the device is alive or not. Type **Target IP** address of the target device and click on **Start** to start the ping. After few seconds, you can see the result in the **Result** field.

### Ping Utility

**Ping**

Target IP

**Result**

```
PING 192.168.10.33 (192.168.10.33): 56 data bytes
64 bytes from 192.168.10.33: icmp_seq=0 ttl=128 time=0.0 ms
64 bytes from 192.168.10.33: icmp_seq=1 ttl=128 time=0.0 ms
64 bytes from 192.168.10.33: icmp_seq=2 ttl=128 time=0.0 ms
64 bytes from 192.168.10.33: icmp_seq=3 ttl=128 time=0.0 ms
64 bytes from 192.168.10.33: icmp_seq=4 ttl=128 time=0.0 ms

--- 192.168.10.33 ping statistics ---
5 packets transmitted, 5 packets received, 0% packet loss
round-trip min/avg/max = 0.0/0.0/0.0 ms
```

#### 4.12.7 CLI Commands of the Monitor and Diag

Command Lines of the Monitor and Diag configuration

Feature	Command Line
---------	--------------

MAC Address Table	
Ageing Time	Switch(config)# mac-address-table aging-time 350 mac-address-table aging-time set ok!  <i>Note: 350 is the new ageing timeout value.</i>
Add Static Unicast MAC address	Switch(config)# mac-address-table static 0012.7701.0101 vlan 1 interface fastethernet7 mac-address-table ucast static set ok!  <b>Note: rule: mac-address-table static MAC_address VLAN VID interface interface_name</b>
Add Multicast MAC address	Switch(config)# mac-address-table multicast 0100.5e01.0101 vlan 1 interface fa6-7 Adds an entry in the multicast table ok!  <b>Note: rule: mac-address-table multicast MAC_address VLAN VID interface_list interface_name/range</b>
Show MAC Address Table – All types	Switch# show mac-address-table  **** UNICAST MAC ADDRESS **** Destination Address    Address Type    Vlan    Destination Port ----- 000f.b079.ca3b        Dynamic        1        fa4 0012.7701.0386        Dynamic        1        fa7 0012.7710.0101        Static        1        fa7 0012.7710.0102        Static        1        fa7 0012.77ff.0100        Management    1  **** MULTICAST MAC ADDRESS **** Vlan    Mac Address        COS    Status    Ports ---- 1    0100.5e40.0800    0    fa6 1    0100.5e7f.ffa    0    fa4,fa6
Show MAC Address Table – Dynamic Learnt MAC addresses	Switch# show mac-address-table dynamic Destination Address    Address Type    Vlan    Destination Port ----- 000f.b079.ca3b        Dynamic        1        fa4 0012.7701.0386        Dynamic        1        fa7
Show MAC Address Table – Multicast MAC addresses	Switch# show mac-address-table multicast Vlan    Mac Address        COS    Status    Ports ---- 1    0100.5e40.0800    0    fa6-7 1    0100.5e7f.ffa    0    fa4,fa6-7
Show MAC Address Table – Static MAC addresses	Switch# show mac-address-table static Destination Address    Address Type    Vlan    Destination Port ----- 0012.7710.0101        Static        1        fa7 0012.7710.0102        Static        1        fa7
Show Aging timeout time	Switch# show mac-address-table aging-time the mac-address-table aging-time is 300 sec.
Port Statistics	
Port Statistics	Switch# show rmon statistics fa4 (select interface) Interface fastethernet4 is enable connected, which has Inbound: Good Octets: 178792, Bad Octets: 0 Unicast: 598, Broadcast: 1764, Multicast: 160 Pause: 0, Undersize: 0, Fragments: 0



	<p>Oversize: 0, Jabbers: 0, Discards: 0  Filtered: 0, RxError: 0, FCSError: 0  Outbound:  Good Octets: 330500  Unicast: 602, Broadcast: 1, Multicast: 2261  Pause: 0, Deferred: 0, Collisions: 0  SingleCollision: 0, MultipleCollision: 0  ExcessiveCollision: 0, LateCollision: 0  Filtered: 0, FCSError: 0  Number of frames received and transmitted with a length of:  64: 2388, 65to127: 142, 128to255: 11  256to511: 64, 512to1023: 10, 1024toMaxSize: 42</p>
<b>Port Mirroring</b>	
Enable Port Mirror	Switch(config)# mirror en Mirror set enable ok.
Disable Port Mirror	Switch(config)# mirror disable Mirror set disable ok.
Select Source Port	Switch(config)# mirror source fa1-2 both Received and transmitted traffic rx Received traffic tx Transmitted traffic Switch(config)# mirror source fa1-2 both Mirror source fa1-2 both set ok.  <b>Note: Select source port list and TX/RX/Both mode.</b>
Select Destination Port	Switch(config)# mirror destination fa6 both Mirror destination fa6 both set ok
Display	Switch# show mirror Mirror Status : Enabled Ingress Monitor Destination Port : fa6 Egress Monitor Destination Port : fa6 Ingress Source Ports :fa1,fa2, Egress Source Ports :fa1,fa2,
<b>Event Log</b>	
Display	Switch# show event-log <1>Jan 1 02:50:47 snmpd[101]: Event: Link 4 Down. <2>Jan 1 02:50:50 snmpd[101]: Event: Link 5 Up. <3>Jan 1 02:50:51 snmpd[101]: Event: Link 5 Down. <4>Jan 1 02:50:53 snmpd[101]: Event: Link 4 Up.
<b>Ping</b>	
Ping IP	Switch# ping 192.168.10.33 PING 192.168.10.33 (192.168.10.33): 56 data bytes 64 bytes from 192.168.10.33: icmp_seq=0 ttl=128 time=0.0 ms 64 bytes from 192.168.10.33: icmp_seq=1 ttl=128 time=0.0 ms 64 bytes from 192.168.10.33: icmp_seq=2 ttl=128 time=0.0 ms 64 bytes from 192.168.10.33: icmp_seq=3 ttl=128 time=0.0 ms 64 bytes from 192.168.10.33: icmp_seq=4 ttl=128 time=0.0 ms  --- 192.168.10.33 ping statistics --- 5 packets transmitted, 5 packets received, 0% packet loss round-trip min/avg/max = 0.0/0.0/0.0 ms

## 4.12 Device Front Panel

Device Front Panel command allows you to see LED status of the switch. You can see LED and link status of the Power, DO, DI, R.M. and Ports.

Feature	On / Link UP	Off / Link Down	Other
Power	Green	Black	
Digital Output	Green	Black	
Digital Input	Green	Black	
R.M.(Ring Master)	Green	Black	
Fast Ethernet	Green	Black	
Gigabit Ethernet	Green	Black	
SFP	Green	Black	Gray: Plugged but not link up yet.

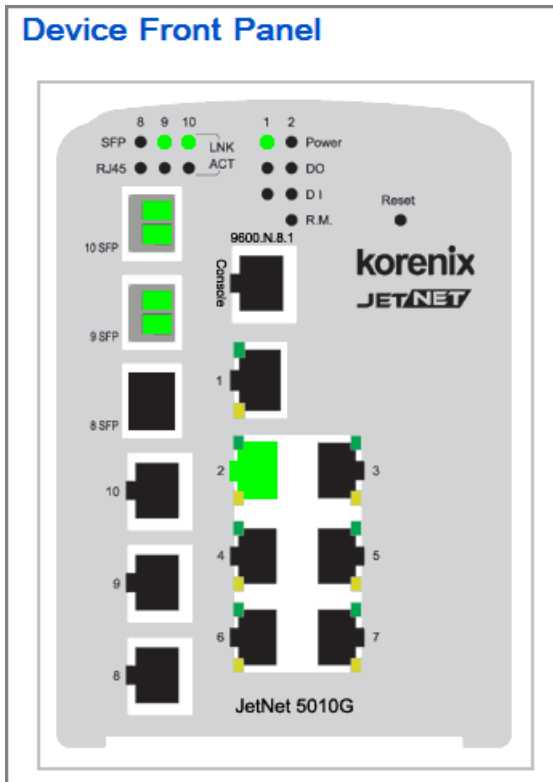

**Note: No CLI command for this feature.**

## 4.13 Save to Flash

**Save Configuration** allows you to save any configuration you just made to the Flash. Powering off the switch without clicking on **Save Configuration** will cause loss of new settings. After selecting **Save Configuration**, click on **Save to Flash** to save your new configuration.

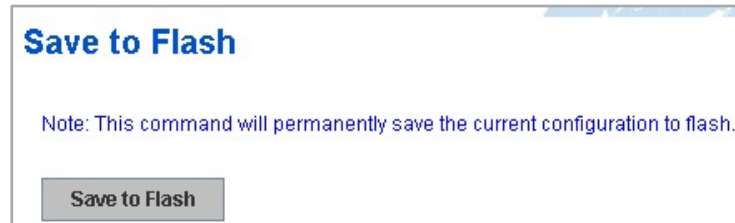

### Command Lines:

Feature	Command Line
Save	SWITCH# write Building Configuration... [OK]  Switch# copy running-config startup-config Building Configuration... [OK]

## 4.14 Logout

The switch provides 2 logout methods. The web connection will be logged out if you don't input any command after 30 seconds. The Logout command allows you to manually logout the web connection. Click on **Yes** to logout, **No** to go back the configuration page.

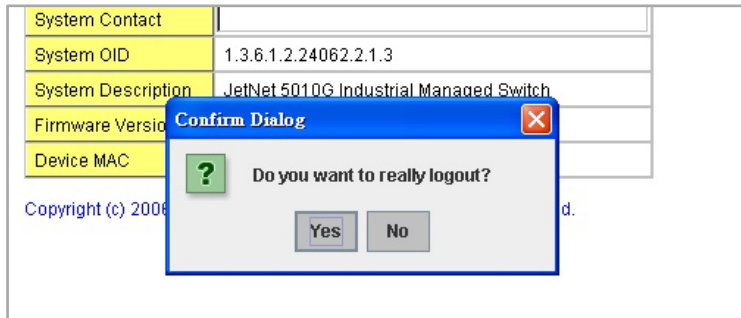

### Command Lines:

Feature	Command Line
Logout	SWITCH> exit SWITCH# exit

# 5. Appendix

## 5.1 Pin Assignment of the RS-232 Console Cable

The total cable length is 150cm, excluding RJ-45 and DB-9!

DB-9 is 'Female.'

RJ-45 Pin	DB-9 Pin	Description
1	8	N/A
2	9	N/A
3	2	<b>TxD</b>
4	1	N/A
5	5	<b>GND</b>
6	3	<b>RxD</b>
7	4	N/A
8	7	N/A

**DB-9 Female Connector**

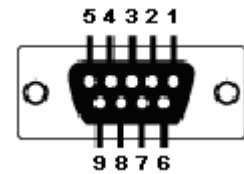

## 5.2 Korenix SFP family

Korenix certificated many types of SFP transceiver. These certificated SFP transceivers can be identified by Switch and displayed in the UI. The SFP transceivers we certificated can meet up the industrial critical environment needs. We recommend you to use Korenix certificated SFP transceivers when you constructing your network.

Korenix will keep on certificating and updating the certificated SFP transceivers in Korenix web site and purchase list. You can refer to the web site to get the latest information about SFP transceivers.

*Note: Poor SFP transceivers may result in poor network performance or can't meet up claimed distance or temperature.*

Model Name	Gigabit SFP Transceiver
<b>SFPGSX</b>	1000Base-SX multi-mode SFP transceiver,550m, -10~70°C
<b>SFPGSX-w</b>	1000Base-SX multi-mode SFP transceiver,550m, wide operating temperature, -40~85°C
<b>SFPGSX2</b>	1000Base-SX plus multi-mode SFP transceiver,2Km, -10~70°C
<b>SFPGSX2-w</b>	1000Base-SX plus multi-mode SFP transceiver, 2Km,wide operating temperature, -10~70°C
<b>SFPGSX10</b>	1000Base-LX single-mode SFP transceiver 10Km, -10~70°C
<b>SFPGSX10-w</b>	1000Base-LX single-mode SFP transceiver, 10Km, wide operating temperature, -40~85°C
<b>SFPGSX30</b>	1000Base-LX single-mode SFP transceiver,30Km, -10~70°C
<b>SFPGSX30-w</b>	1000Base-LX single-mode SFP transceiver, 30Km, wide operating temperature, -40~85°C
<b>SFPGXD50</b>	1000Base-XD single-mode SFP transceiver, 50Km, -10~70°C
<b>SFPGXD50-w</b>	1000Base-XD single-mode SFP transceiver, 50Km, wide operating temperature, -40~85°C
<b>SFPGZX70</b>	1000Base-ZX single-mode SFP transceiver, 70Km, -10~70°C
<b>SFPGZX70-w</b>	1000Base-ZX single-mode SFP transceiver, 70Km, -40°C - 85°C

Model Name	Gigabit BIDI/WDM SFP Transceiver
<b>SFPGX10B13</b>	1000Base-LX, single-mode, TX 1310nm/ RX 1550nm,10Km, -10~70°C
<b>SFPGX10B13-w</b>	1000Base-LX single-mode, TX 1310nm/ RX 1550nm,10Km, -40°C - 85°C
<b>SFPGX10B15</b>	1000Base-LX, single-mode, TX 1550nm/ RX 1310nm,10Km, -10~70°C
<b>SFPGX10B15-w</b>	1000Base-LX single-mode, TX 1550nm/ RX 1310nm,10Km, -40°C - 85°C
<b>SFPGX20B13</b>	1000Base-LX, single-mode, TX 1310nm/ RX 1550nm,10Km, -10~70°C
<b>SFPGX20B13-w</b>	1000Base-LX single-mode, TX 1310nm/ RX 1550nm, 10Km, -40°C - 85°C
<b>SFPGX20B15</b>	1000Base-LX, single-mode, TX 1550nm/ RX 1310nm, 20Km, -10~70°C
<b>SFPGX20B15-w</b>	1000Base-LX single-mode, TX 1550nm/ RX 1310nm, 20Km, -40°C - 85°C
<b>SFPGX40B13</b>	1000Base-LX, single-mode, TX 1310nm/ RX 1550nm,40Km, -10~70°C
<b>SFPGX40B13-w</b>	1000Base-LX single-mode, TX 1310nm/ RX 1550nm, 40Km, -40°C - 85°C

<b>SFPGLX40B15</b>	1000Base-LX, single-mode, TX 1550nm/ RX 1310nm, 40Km, -10~70°C
<b>SFPGLX40B15-w</b>	1000Base-LX single-mode, TX 1550nm/ RX 1310nm, 40Km, -40°C - 85°C
<b>SFPGLX60B13</b>	1000Base-LX, single-mode, TX 1310nm/ RX 1550nm,60Km, -10~70°C
<b>SFPGLX60B15</b>	1000Base-LX, single-mode, TX 1550nm/ RX 1310nm, 60Km, -10~70°C

<b>Model Name</b>	<b>100Mbps SFP Transceiver</b>
<b>SFP100MM</b>	Multi-mode 100Mbps 2KM Fiber Transceiver, -10~70°C.
<b>SFP100MM-w</b>	Multi-mode 100Mbps 2KM Fiber Transceiver, wide operating temperature -40~85°C.
<b>SFP100SM30</b>	Single mode 100Mbps 30KM Fiber Transceiver -10~70°C.
<b>SFP100SM30-w</b>	Single mode 100Mbps 30Km Fiber Transceiver, wide operating temperature. -40~85°C
<b>SFP100SM60</b>	Single mode 100Mbps 60KM Fiber Transceiver -10~70°C.
<b>SFP100SM60-w</b>	Single mode 100Mbps 60Km Fiber Transceiver, wide operating temperature. -40~85°C
<b>SFP100SM80</b>	Single mode 100Mbps 80KM Fiber Transceiver -10~70°C.
<b>SFP100SM80-w</b>	Single mode 100Mbps 80Km Fiber Transceiver, wide operating temperature. -40~85°C
<b>SFP100SM100</b>	Single mode 100Mbps 100KM Fiber Transceiver -10~70°C.
<b>SFP100SM100-w</b>	Single mode 100Mbps 100Km Fiber Transceiver, wide operating temperature. -40~85°C
<b>SFP100SM120</b>	Single mode 100Mbps 120KM Fiber Transceiver -10~70°C.
<b>SFP100SM120-w</b>	Single mode 100Mbps 120Km Fiber Transceiver, wide operating temperature. -40~85°C

<b>Model Name</b>	<b>100Mbps BIDI/WDM SFP Transceiver</b>
<b>SFP100SM20B13</b>	Single mode 100Mbps, TX 1310nm/RX 1550nm, 20Km Fiber Transceiver, -10~70 °C
<b>SFP100SM20B13-w</b>	Single mode 100Mbps, TX 1310nm/RX 1550nm, 20Km Fiber Transceiver, -40~85 °C
<b>SFP100SM20B15</b>	Single mode 100Mbps, TX 1550nm/RX 1310nm, 20Km Fiber Transceiver, -10~70 °C
<b>SFP100SM20B15-w</b>	Single mode 100Mbps, TX 1550nm/RX 1310nm, 20Km Fiber Transceiver, -40~85 °C
<b>SFP100SM40B13</b>	Single mode 100Mbps, TX 1310nm/RX 1550nm, 40Km Fiber Transceiver, -10~70 °C
<b>SFP100SM40B13-w</b>	Single mode 100Mbps, TX 1310nm/RX 1550nm, 40Km Fiber Transceiver, -40~85 °C
<b>SFP100SM40B15</b>	Single mode 100Mbps, TX 1550nm/RX 1310nm, 40Km Fiber Transceiver, -10~70°C
<b>SFP100SM40B15-w</b>	Single mode 100Mbps, TX 1550nm/RX 1310nm, 40Km Fiber Transceiver, -40~85 °C
<b>SFP100SM60B13</b>	Single mode 100Mbps, TX 1310nm/RX 1550nm, 60Km Fiber Transceiver, -10~70 °C
<b>SFP100SM60B13-w</b>	Single mode 100Mbps, TX 1310nm/RX 1550nm, 60Km Fiber Transceiver,

	-40~85 °C
<b>SFP100SM60B15</b>	Single mode 100Mbps, TX 1550nm/RX 1310nm, 60Km Fiber Transceiver, -10~70 °C
<b>SFP100SM60B15-w</b>	Single mode 100Mbps, TX 1550nm/RX 1310nm, 60Km Fiber Transceiver, -40~85 °C





## 5.4 ModBus TCP /IP

The Modbus TCP/IP is very similar to Modbus RTU, but transmits data within TCP/IP Data packets. It was developed in 1979 for industrial automatic communication system and has become a standard protocol for industrial communication for the transfer of discrete analog I/O devices or PLC systems. It defines a simple protocol data unit independent of the underlying data link layer. The Modbus TCP packet includes 3 parts - MBAP header, function code and data payload, the MBAP header is used on TCP/IP header to identify the Modbus application Data Unit and provides some differences compared to the MODBUS RTU application data unit used on a serial line. The MBAP header also includes unit identifier to recognize and communicate between multiple independent Modbus end units.

The Modbus devices communicate using a master (client) /slave (server) architecture, only one device can initiate a transaction and the others respond to the master/client. The other devices (slave/server) respond by supplying the requested data to the master/client, or by taking the action requested in the query. The slave/server can be any peripheral device (DSC unit, PLC unit, Volt/Current Transducer, network communication switch) which processes information and sends the output data to the master using the Modbus TCP protocol. A Korenix JetNet Switch operating as a slave/server device, while a typical master/client device is a host computer running appropriate application software, like a SCADA / HMI system. The transaction architecture is like the drawing following.

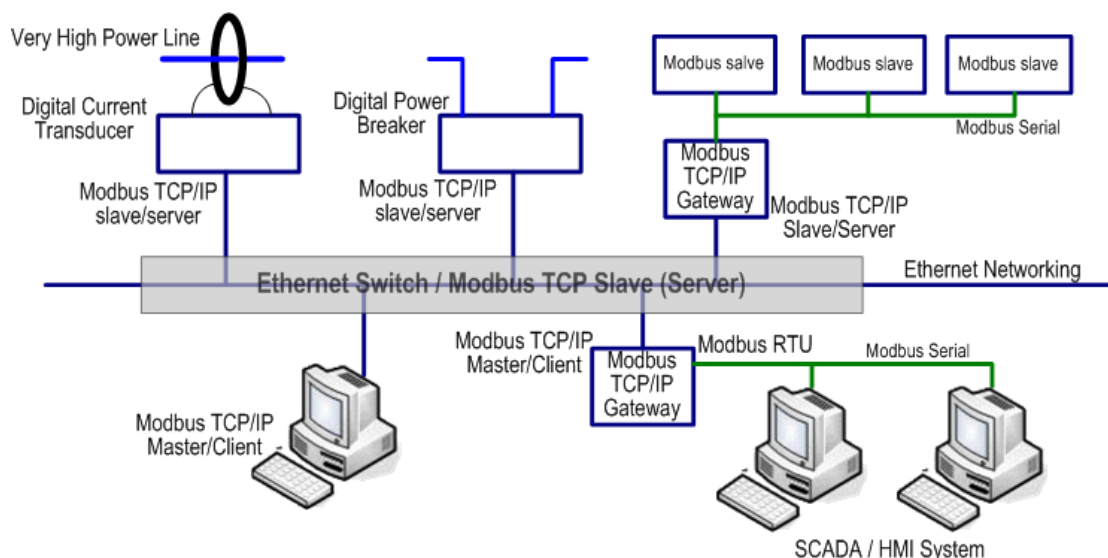

There are three most common Modbus versions, Modbus ASCII, Modbus RTU and Modbus TCP. Ethernet based device, Industrial Ethernet Switch for example, supports Modbus TCP that it can be polled through Ethernet. Thus the Modbus TCP master can read or write the Modbus registers provided by the Industrial Ethernet Switch.

The JetNet Managed DIN-Rail Ethernet Switch has implemented Modbus/TCP register in the firmware. Those register mapping to some of Ethernet Switches' operating information, includes description, IP address, power status, interface status, interface information and inbound/outbound packet statistics. With the register supports, user can read the information through their own Modbus TCP based progress/ display/ monitor applications and monitor the status of the switch easily.

The configuration of Modbus/TCP only present in CLI management mode and there is no extra user interface for Web configuration.

#### 5.4.1 Modbus Function Code

The Modbus TCP device uses a subset of the standard Modbus TCP function code to access device-dependent information. Modbus TCP function code is defined as below.

FC	Name	Usage
01	Read Coils	Read the state of a digital output
02	Read Input Status	Read the state of a digital input
03	Read Holding Register	Read holding register in 16-bits register format
04	Read Input Registers	Read data in 16-bits register format
05	Write Coil	Write data to force a digital output ON/OFF
06	Write Single Register	Write data in 16-bits register format
15	Force Multiple Coils	Write data to force multiple consecutive coils

The JetNet device supports the function code 04, which name is Read Input Registers. With this support, the SCADA or other Modbus TCP application can poll the information of the device and monitor the major status of the switch.

#### 5.4.2 Error Checking

The utilization of the error checking will help eliminate errors caused by noise in the communication link. In Modbus TCP mode, messages include an error-checking field that is based on a Cyclical Redundancy Check (CRC) method. The CRC field checks the contents of the entire message. It applied regardless of any parity check method used for the individual BYTE octets of the message. The CRC value is calculated by the transmitting device, which appends the CRC to the message. The receiving device recalculates a CRC during receipt of the message, and compares the calculated value to the actual value it received in the CRC field.

#### 5.4.3 Exception Response

If an error occurs, the slave sends an exception response message to master consisting of the slave address, function code, exception response code and error check field. In an exception response, the slave sets the high-order bit (MSB) of the response function code to one. The exception response codes are listed below.

Code	Name	Descriptions
01	Illegal Function	The message function received is not allowable action.
02	Illegal Data Address	The address referenced in the data field is not valid.
03	Illegal Data Value	The value referenced at the addressed device location is no within range.
04	Slave Device Failure	An unrecoverable error occurred while the slave was attempting to perform the requested action.
05	Acknowledge	The slave has accepted the request and processing it, but a long duration of time will be required to do so.
06	Slave Device Busy	The slave is engaged in processing a long-duration program command.
07	Negative Acknowledge	The slave cannot perform the program function received in the query.
08	Memory Parity Error	The slave attempted to read extended memory, but detected a parity error in the memory.

#### 5.4.4 Modbus TCP register table

Since from firmware version 2.5, the **7+3G** Switch and **7+3 100** Switch start support Modbus TCP/IP client service for the Factory automation applications.

The command of modbus only supports in the command line interface- console and telnet mode that allows user to modify some parameters like as idle time, number of modbus master and modbus service port.

Word Address	Data Type	Description
<b>System Information</b>		
0x0000	16 words	Vender Name = "Korenix" Word 0 Hi byte = 'K' Word 0 Lo byte = 'o' Word 1 Hi byte = 'r' Word 1 Lo byte = 'e' Word 2 Hi byte = 'n' Word 2 Lo byte = 'l' Word 2 Hi byte = 'x' Word 2 Lo byte = '0' (other words = 0)
0x0010	16 words	Product Name = "JetNet5828G" Word 0 Hi byte = 'J' Word 0 Lo byte = 'e' Word 1 Hi byte = 'T' Word 1 Lo byte = 'N'

		Word 2 Hi byte = 'e' Word 2 Lo byte = 't' Word 3 Hi byte = '5' Word 3 Lo byte = '8' Word 4 Lo byte = '2' Word 4 Hi byte = '8' Word 5 Lo byte = 'G' Word 5 Hi byte = '0' (other words = 0)
0x0020	128 words	SNMP system name (string)
0x00A0	128 words	SNMP system location (string)
0x0120	128 words	SNMP system contact (string)
0x01A0	32 words	SNMP system OID (string)
0x01C0	2 words	System uptime (unsigned long)
0x01C2 to 0x01FF	60 words	Reserved address space
0x0200	2 words	hardware version
0x0202	2 words	S/N information
0x0204	2 words	CPLD version
0x0206	2 words	Boot loader version
0x0208	2 words	Firmware Version Word 0 Hi byte = first number of version Word 0 Lo byte = second number of version Word 1 Hi byte = third number of version Word 1 Lo byte = extended character of version Ex: Version = v1.2a Word 0 Hi byte = 0x1 Word 0 Lo byte = 0x2 Word 1 Hi byte = 0x0 Word 1 Lo byte = 'a' Version = v1.2.3a Word 0 Hi byte = 0x1 Word 0 Lo byte = 0x2 Word 1 Hi byte = 0x3 Word 1 Lo byte = 'a' Version = v1.2.3.4 Word 0 Hi byte = 0x1 Word 0 Lo byte = 0x2 Word 1 Hi byte = 0x3 Word 1 Lo byte = 0x0
0x020A	2 words	Firmware Release Date Firmware was released on 2010-08-11 at 09 o'clock Word 0 = 0x0B09 Word 1 = 0x0A08
0x020C	3 words	Ethernet MAC Address Ex: MAC = 01-02-03-04-05-06 Word 0 Hi byte = 0x01 Word 0 Lo byte = 0x02 Word 1 Hi byte = 0x03 Word 1 Lo byte = 0x04 Word 2 Hi byte = 0x05 Word 2 Lo byte = 0x06
0x020F to 0x2FF	241 words	Reserved address space
0x0300	2 words	IP address Ex: IP = 192.168.10.1 Word 0 Hi byte = 0xC0 Word 0 Lo byte = 0xA8

		Word 1 Hi byte = 0x0A Word 1 Lo byte = 0x01
0x0302	2 words	Subnet Mask
0x0304	2 words	Default Gateway
0x0306	2 words	DNS Server
0x0308 to 0x3FF	248 words	Reserved address space (IPv6 or others)
0x0400	1 word	AC1 0x0000:Off 0x0001:On 0xFFFF: unavailable
0x0401	1 word	AC2 0x0000:Off 0x0001:On 0xFFFF: unavailable
0x0402	1 word	DC1 0x0000:Off 0x0001:On 0xFFFF: unavailable
0x0403	1 word	DC2 0x0000:Off 0x0001:On 0xFFFF: unavailable
0x0404 to 0x040F	12 words	Reserved address space
0x0410	1 word	DI1 0x0000:Off 0x0001:On 0xFFFF: unavailable
0x0411	1 word	DI2 0x0000:Off 0x0001:On 0xFFFF: unavailable
0x0412	1 word	DO1 0x0000:Off 0x0001:On 0xFFFF: unavailable
0x0413	1 word	DO2 0x0000:Off 0x0001:On 0xFFFF: unavailable
0x0414 to 0x041F	12 words	Reserved address space
0x0420	1 word	RDY 0x0000:Off 0x0001:On
0x0421	1 word	RM / RS (Green light) 0x0000:Off 0x0001:On
0x0422	1 word	RF / RS – (Yellow light) 0x0000:Off 0x0001:On
0x0423 to 0x0BFF	2103 words	Reserved address space
0x0C00	1 words	Clear all rmon information Write 0x0001 to clear Read to return 0x0000
0x0C01	1 words	Clear rmon by bitmap of port 1 to 16 Write to clear Read to return 0x0000

		To clear port 1 Word = 0x0001 To clear port 1 and 2 Word = 0x0003
0x0C02	1 words	Clear rmon by bitmap of port 17 to 32 Write to clear Read to return 0x0000 To clear port 17 Word = 0x0001 To clear port 17 and 18 Word = 0x0003
0x0C03 to 0x0FFF	1021 words	Reserved address space
<b>Port Information (32 Ports)</b>		
0x1000 to 0x11FF	16 words	Port Name
0x1200 to 0x121F	1 word	Administrative Status 0x0000: disable 0x0001: enable
0x1220 to 0x123F	1 word	Operating Status 0x0000: disable 0x0001: enable 0xFFFF: unavailable
0x1240 to 0x125F	1 word	Duplex 0x0000: half 0x0001: full 0x0003: auto (half) 0x0004: auto (full) 0x0005: auto 0xFFFF: unavailable
0x1260 to 0x127F	1 word	Speed 0x0001: 10 0x0002: 100 0x0003: 1000 0x0004: 2500 0x0005: 10000 0x0101: auto 10 0x0102: auto 100 0x0103: auto 1000 0x0104: auto 2500 0x0105: auto 10000 0x0100: auto 0xFFFF: unavailable
0x1280 to 0x129F	1 word	Flow Control 0x0000: off 0x0001: on 0xFFFF: unavailable
0x12A0 to 0x12BF	1 word	Default Port VLAN ID 0x0001-0xFFFF
0x12C0 to 0x12DF	1 word	Ingress Filtering 0x0000: disable 0x0001: enable
0x12E0 to 0x12FF	1 word	Acceptable Frame Type 0x0000: all 0x0001: tagged frame only
0x1300 to 0x131F	1 word	Port Security 0x0000: disable 0x0001: enable

0x1320 to 0x133F	1 word	Auto Negotiation 0x0000: disable 0x0001: enable 0xFFFF: unavailable
0x1340 to 0x135F	1 word	Loopback Mode 0x0000: none 0x0001: MAC 0x0002: PHY 0xFFFF: unavailable
0x1360 to 0x137F	1 word	STP Status 0x0000: disabled 0x0001: blocking 0x0002: listening 0x0003: learning 0x0004: forwarding
0x1380 to 0x139F	1 word	Default CoS Value for untagged packets
0x13A0 to 0x13BF	1 word	MDIX 0x0000: disable 0x0001: enable 0x0002: auto 0xFFFF: unavailable
0x13C0 to 0x13DF	1 word	Medium mode 0x0000: copper 0x0001: fiber 0x0002: none 0xFFFF: unavailable
0x13E0 to 0x13FF	1 word	Medium type 0x0000: none 0x0001: 100baseTX 0x0002: 1000baseT 0x0003: 100BaseFX 0x0004: 1000BaseSX 0x0005: 1000BaseLX 0x0006: other fiber transceiver 0x0007: fiber transceiver is not present 0xFFFF: unavailable
0x1400 to 0x14FF	288 words	Reserved address space
<b>SFP Information (32 Ports)</b>		
0x1500 to 0x151F	1 word	SFP Type
0x1520 to 0x153F	1 words	Wave length
0x1540 to 0x157F	2 words	Distance
0x1580 to 0x167F	8 words	Vender
0x1680 to 0x17FF	384 words	Reserved address space
<b>SFP DDM Information (32 Ports)</b>		
0x1800 to 0x181F	1 words	Temperature Raw data
0x1820 to 0x185F	2 words	Alarm Temperature Word 0 : Raw data of High Alarm Word 1 : Raw data of Low Alarm
0x1860 to 0x187F	1 words	Tx power Raw data
0x1880 to 0x18BF	2 words	Warning Tx power Word 0 : Raw data of High Alarm Word 1 : Raw data of Low Alarm



0x18C0 to 0x18DF	1 words	Rx power Raw data
0x18E0 to 0x191F	2 words	Warning Rx power Word 0 : Raw data of High Alarm Word 1 : Raw data of Low Alarm
0x1920 to 0x1FFF	1760 words	Reserved address space
<b>Inbound packet information</b>		
0x2000 to 0x203F	2 words	Good Octets
0x2040 to 0x207F	2 words	Bad Octets
0x2080 to 0x20BF	2 words	Unicast
0x20C0 to 0x20FF	2 words	Broadcast
0x2100 to 0x213F	2 words	Multicast
0x2140 to 0x217F	2 words	Pause
0x2180 to 0x21BF	2 words	Undersize
0x21C0 to 0x21FF	2 words	Fragments
0x2200 to 0x223F	2 words	Oversize
0x2240 to 0x227F	2 words	Jabbers
0x2280 to 0x22BF	2 words	Disacrd
0x22C0 to 0x22FF	2 words	Filtered frames
0x2300 to 0x233F	2 words	RxError
0x2340 to 0x237F	2 words	FCSError
0x2380 to 0x23BF	2 words	Collisions
0x23C0 to 0x23FF	2 words	Dropped Frames
0x2400 to 0x243F	2 words	Last Activated SysUpTime
0x2440 to 0x24FF	192 words	Reserved address space
<b>Outbound packet information</b>		
0x2500 to 0x253F	2 words	Good Octets
0x2540 to 0x257F	2 words	Unicast
0x2580 to 0x25BF	2 words	Broadcast
0x25C0 to 0x25FF	2 words	Multicast
0x2600 to 0x263F	2 words	Pause
0x2640 to 0x267F	2 words	Deferred
0x2680 to 0x26BF	2 words	Collisions
0x26C0 to	2 words	SingleCollision

0x26FF		
0x2700 to 0x273F	2 words	MultipleCollision
0x2740 to 0x277F	2 words	ExcessiveCollision
0x2780 to 0x27BF	2 words	LateCollision
0x27C0 to 0x27FF	2 words	Filtered
0x2800 to 0x283F	2 words	FCSError
0x2840 to 0x29FF	448 words	Reserved address space
<b>Number of frames received and transmitted with a length(in octets)</b>		
0x2A00 to 0x2A3F	2 words	64
0x2A40 to 0x2A7F	2 words	65 to 127
0x2A80 to 0x2ABF	2 words	128 to 255
0x2AC0 to 0x2AFF	2 words	256 to 511
0x2B00 to 0x2B3F	2 words	512 to 1023
0x2B40 to 0x2B7F	2 words	1024 to maximum size
0x2B80 to 0x2FFF	1152 words	Reserved address space
<b>Network Redundancy Information</b>		
0x3000	10 words	Ring 0's Name Ring Name = "Ring0" Word 0 Hi byte = 'R' Word 0 Lo byte = 'i' Word 1 Hi byte = 'n' Word 1 Lo byte = 'g' Word 2 Hi byte = '0' Word 2 Lo byte = '0' (other words = 0)
0x300A	1 word	Ring 0's Status 0x0000: none 0x0001: disable 0x0002: normal 0x0003: abnormal
0x300B	1 word	Ring 0's Version 0x0000: none 0x0001: Super Ring 0x0002: Rapid Super Ring 0x0003: Any Ring 0x0004: not support 0xFFFF: unavailable
0x300C	1 word	Ring 0's Device Role 0x0000: none 0x0001: disable 0x0002: RM (Ring Master) 0x0003: non-RM 0xFFFF: unavailable
0x300D	2 word	Ring 0's Port List of 1st Ring Port Word 0 = port 1-16

		Word 1 = port 17-32 Ex: 0x0001: Ethernet port 1 0x0002: Ethernet port 2 0x0003: Ethernet port 1 and 2
0x300F	2 word	Ring 0's Port List of 2nd Ring Port Word 0 = port 1-16 Word 1 = port 17-32 Ex: 0x0001: Ethernet port 1 0x0002: Ethernet port 2 0x0003: Ethernet port 1 and 2
0x3011	3 words	Ring 0's Master MAC address Ex: MAC = 01-02-03-04-05-06 Word 0 Hi byte = 0x01 Word 0 Lo byte = 0x02 Word 1 Hi byte = 0x03 Word 1 Lo byte = 0x04 Word 2 Hi byte = 0x05 Word 2 Lo byte = 0x06
0x3014	2 word	Ring 0's Blocked Port List Word 0 = port 1-16 Word 1 = port 17-32 Ex: 0x0001: Ethernet port 1 0x0002: Ethernet port 2 0x0003: Ethernet port 1 and 2
0x3016	1 word	Ring 0's Rapid Dual Homing Status 0x0000: none 0x0001: disable 0x0002: enable 0xFFFF: unavailable
0x3017 to 0x301F	9 words	Reserved address space
0x3020 to 0x303F		Ring 1's Information
0x3040 to 0x305F		Ring 2's Information
0x3060 to 0x307F		Ring 3's Information
0x3080 to 0x309F		Ring 4's Information
0x30A0 to 0x30BF		Ring 5's Information
0x30C0 to 0x30DF		Ring 6's Information
0x30E0 to 0x30FF		Ring 7's Information
0x3100 to 0x311F		Ring 8's Information
0x3120 to 0x313F		Ring 9's Information
0x3140 to 0x315F		Ring 10's Information
0x3160 to 0x317F		Ring 11's Information
0x3180 to		Ring 12's Information

0x319F		
0x31A0 to 0x31BF		Ring 13's Information
0x31C0 to 0x31DF		Ring 14's Information
0x31E0 to 0x31FF		Ring 15's Information
0x3200 to 0x321F		Ring 16's Information
0x3220 to 0x323F		Ring 17's Information
0x3240 to 0x325F		Ring 18's Information
0x3260 to 0x327F		Ring 19's Information
0x3280 to 0x329F		Ring 20's Information
0x32A0 to 0x32BF		Ring 21's Information
0x32C0 to 0x32DF		Ring 22's Information
0x32E0 to 0x32FF		Ring 23's Information
0x3300 to 0x331F		Ring 24's Information
0x3320 to 0x333F		Ring 25's Information
0x3340 to 0x335F		Ring 26's Information
0x3360 to 0x337F		Ring 27's Information
0x3380 to 0x339F		Ring 28's Information
0x33A0 to 0x33BF		Ring 29's Information
0x33C0 to 0x33DF		Ring 30's Information
0x33E0 to 0x33FF		Ring 31's Information

**Note: the modbus TCP client will return 0xFFFF to modbus master when pulling reserved address.**

#### 5.4.5 CLI commands for Modbus TCP

The CLI commands of Modbus TCP are listed as following table.

Feature	Command & example
Enable Modbus TCP	Switch(config)# modbus enable
Disable Modbus TCP	Switch(config)# modbus disable
Set Modbus interval time between request	Switch(config)# modbus idle-timeout <200-10000> Timeout vlaue: 200-10000ms Switch(config)# modbus idle-timeout 200 → set interval

	request time out duration to 200ms.
Set modbus TCP master communicate session.	Switch(config)# modbus master <1-20> Max Modbus TCP Master Switch(config)# modbus master 2 → set maximum modbus master up to 2; maximum support up to 20 modbus communicate sessions.
Set modbus TCP listening port	Switch(config)# modbus port port Listening Port Switch(config)# modbus port 502 ; default modbus TCP service port is 502.

## 5.5 Revision History

Edition	Date	Modifications
V2.13	Nov,2014	<ul style="list-style-type: none"> <li>■ Add CLI command: Super Chain RDH Ext. ID</li> </ul>
V2.12	OCT-2014	<ul style="list-style-type: none"> <li>■ Firmware v2.8a new features: ITU-T G.8032 ERPS /Web UI change Super Chain/Web UI change Extend RDH ID: 256 RDH Rings /Web UI change Multiple Realy Alarm /WebUI change Ethernet /IP /CLI Command change Rate Control counting with Inter Frame gap, w/o interface change</li> </ul>
V2.11	20-Apr-2013	<ul style="list-style-type: none"> <li>■ Firmware version v2.6a, v2.7 with following new features.  <b>V2.6a:</b>  Add new features to Modbus TCP protocol  <b>V2.7:</b>  IPv6 features  Port-Based DHCP Server with fixed IP addressfeatures  SSH, SSL certification key allows user change.  Support local console, SSH and SSL with Radius authentication.  Telnet, HTTP service enable/ disable function  Restrict maximum 20 command entry records to be storage in system.  Integrated JetNet 5010G and JetNet 4510 in one user manual.</li> </ul>
V2.10	18-Jun, 2012	<ul style="list-style-type: none"> <li>● Add New Features – Port Based Loop Protect function in network redundancy and waning selection. ( firmware V2.6)</li> <li>● Add new hardware version -2.3: power input range 10.5~60V dc, typical input DC24V.</li> </ul>

		<ul style="list-style-type: none"> <li>● Change dimension drawing for V2.3 hardware.</li> <li>● Change operating temperature for v2.3 wide temperature model - -40~75°C.</li> </ul>
V2.9a	29-Nov,2011	Update Modbus TCP/IP chapter with more information.
V2.9	11-OCT,2011	<p>The following change and new features applied to version 2.5 firmwre</p> <ul style="list-style-type: none"> <li>● Add new feature: Modbus TCP/IP, new daylight saving mode and CLI commands</li> <li>● Change drawing for Warning event selection</li> <li>● Add SFP transceiver Eject function with drawing update.</li> <li>● Add Modbus TCP/Ip register table in chapter 5.4</li> </ul>
V2.8	Jun-2011	<ul style="list-style-type: none"> <li>● Correct Index.</li> <li>● Add UL information for installation and SFP Fiber transceiver.</li> </ul>
V2.7	11-Nov. 2010	<ul style="list-style-type: none"> <li>● Apply to the New Firmware V2.4</li> <li>● Update major feature description</li> <li>● Remove product specification from the manual; please check the most up to date datasheet from Korenix Web.</li> <li>● Add <b>802.1s Multiple Spanning Tree Protocol</b> description and configuration pages in Network Redundancy chapter.</li> <li>● Modify Multiple Super Ring description in Network Redundancy chapter.</li> <li>● Add <b>Private VLAN</b> description and configuration pages, new chapter in this version.</li> <li>● Add <b>QinQ</b> description and configuration pages in VLAN chapter.</li> <li>● Add extended LACP Long/Short Timeout description and configuration CLI in Port Turnking chapter.</li> </ul>
V2.6	5-Feb,2010	Add DHCP relay agent function
V2.5	25-Jun,2009	Support SFP DDM function in port status and warning selection.
V2.4	1-Aug,2008	Add SFP order information
V2.3	18,July,2008	Change housing & add more information for UL 60950-1
V2.2	20 Jun,2008	Modify the Pin Failure description of warning.
V2.1	May 15, 2008	<p>Modify Multiple Super Ring function  Modify Rapid Dual Homing  Modify IGMP function  Add Time Synchronize Failure warning event  Modify Private MIB ID</p>
V2.0	Oct. 23, 2007	<p>Modify System Time function  Add GVRP function  Add IGMP snooping V3 description  Modify Rapid Super Ring function  Add Force filtering function  Add IEEE 802.1x function</p>
V1.1	Jul. 23, 2007	<p>Add DHCP server setting  Add IGMP Query setting  Add SNMP v3 setting</p>

		Correct the incorrect wording and update the latest Web UI figures
V1.0	Mar. 1, 2007	Add Auto Ring Coupling figure and description. Modify VLAN description.

## 5.6 About Korenix

### **Less Time At Work! Fewer Budget on applications!**

The Korenix business idea is to let you spend less time at work and fewer budget on your applications. Do you really want to go through all the troubles but still end up with low quality products and lousy services? Definitely not! This is why you need Korenix. Korenix offers complete product selection that fulfills all your needs for applications. We provide easier, faster, tailor-made services, and more reliable solutions. In Korenix, there is no need to compromise. Korenix takes care of everything for you!

### **Fusion of Outstandings**

**You can end** your searching here. Korenix Technology is your one-stop supply center for industrial communications and networking products. Korenix Technology is established by a group of professionals with more than 10 year experience in the arenas of industrial control, data communications and industrial networking applications. Korenix Technology is well-positioned to fulfill your needs and demands by providing a great variety of tailor-made products and services. Korenix's industrial-grade products also come with quality services. No more searching, and no more worries. Korenix Technology stands by you all the way through.

### **Core Strength---Competitive Price and Quality**

With our work experience and in-depth know-how of industrial communications and networking, Korenix Technology is able to combine Asia's research / development ability with competitive production cost and with quality service and support.

### **Global Sales Strategy**

Korenix's global sales strategy focuses on establishing and developing trustworthy relationships with value added distributors and channel partners, and assisting OEM distributors to promote their own brands. Korenix supplies products to match local market requirements of design, quality, sales, marketing and customer services, allowing Korenix and distributors to create and enjoy profits together.

### **Quality Services**

**KoreCARE---** KoreCARE is Korenix Technology's global service center, where our professional staffs are ready to solve your problems at any time and in real-time. All of Korenix's products have passed ISO-9000/EMI/CE/FCC/UL certifications, fully satisfying your demands for product quality under critical industrial environments. Korenix global service center's e-mail is [koreCARE@korenix.com](mailto:koreCARE@korenix.com)

### **5 Years Warranty**

Each of Korenix's product line is designed, produced, and tested with high industrial standard. Korenix warrants that the Product(s) shall be free from defects in materials and workmanship for a period of five (5) years from the date of delivery provided that the Product was properly installed and used. This warranty is voided if defects, malfunctions or failures of the warranted Product are caused by damage resulting from force measure (such as floods, fire, etc.), environmental and atmospheric disturbances, other external forces such as power line disturbances, host computer malfunction, plugging the board in under power, or incorrect cabling; or the warranted Product is misused, abused, or operated, altered and repaired in an unauthorized or improper way

**Business service :** [sales@korenix.com](mailto:sales@korenix.com)

**Customer service:** [koreCARE@korenix.com](mailto:koreCARE@korenix.com)