

I-8014W User Manual

**250 KS/s, 16-bit, 8-channel differential/16-channel
single-ended analog input module**

Version 1.0.1/ September 2011

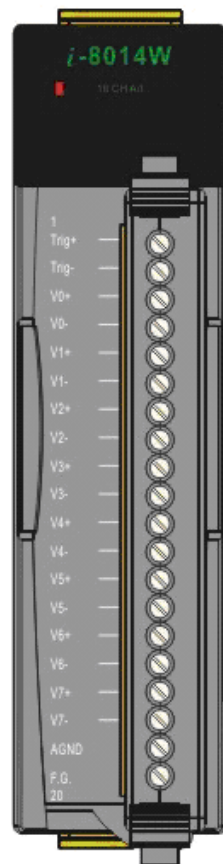

Warranty

All products manufactured by ICP DAS are under warranty regarding defective materials for a period of one year, beginning from the date of delivery to the original purchaser.

Warning

ICP DAS assumes no liability for any damage resulting from the use of this product. ICP DAS reserves the right to change this manual at any time without notice. The information furnished by ICP DAS is believed to be accurate and reliable. However, no responsibility is assumed by ICP DAS for its use, not for any infringements of patents or other rights of third parties resulting from its use.

Copyright

Copyright © 2011 by ICP DAS Co., Ltd. All rights are reserved.

Trademark

The names used for identification only may be registered trademarks of their respective companies.

Contact US

If you have any problem, please feel free to contact us.

You can count on us for quick response.

Email: service@icpdas.com

Table of Contents

Table of Contents	3
Preface.....	5
Hardware	6
Specifications	6
Pin Assignments	7
Jumper setting	8
Wire Connection	10
Block Diagram	11
Demo Programs Location	12
Quick Start	14
On MiniOS7 platform controller	14
Getting Started Guide	14
Calibration	17
On Windows platform controller	26
Getting Started Guide	26
Calibration	28
Magic Scan.....	35
Magic Scan Mode.....	36
Standard mode	37
Virtual Sample and hold mode	38
Trigger method.....	39
Software trigger method	39
Internal hardware trigger method	40
External hardware trigger method	41
FIFO.....	42
Magic Scan Procedure	43
Magic Scan Example	44

Magic.exe	44
Mag_ISR.exe	50
Case Example	51
API.....	53
Function list	54
Error code list	55
i8014W_Init	56
i8014W_GetFirmwareVer_L1	58
i8014W_GetFirmwareVer_L2	59
i8014W_GetLibVersion	60
i8014W_GetLibDate	61
i8014W_GetSingleEndJumper	62
i8014W_ReadGainOffset	64
i8014W_ReadAI	66
i8014W_ReadAIHex	68
i8014W_ConfigMagicScan	70
i8014W_StartMagicScan	73
i8014W_StopMagicScan	74
i8014W_ReadFIFO	75
i8014W_CalibrateData	77
i8014W_CalibrateDataHex	79
i8014W_UnLockFIFO	81
i8014W_ClearFIFO	82
i8014W_InstallMagicScanISR	83
i8014W_UnInstallMagicScanISR	86
i8014W_ClearInt	87
Troubleshooting	88
How to verify the AI function on WinCE or WES unit?	88
Service-request requirement	92
Why does the data read from I-8014W seem unstable?	92
How to solve FIFO LATCHED error (-6)?	93

Preface

The I-8014W is a 16-bit resolution, high speed isolated analog input module providing 16 single-ended or 8 differential analog input channels. Besides basic usage knowledge and SDK interface, this manual intends to introduce the Magic Scan function of I-8014W for scanning multi-channel system.

This manual contains

- [Chapter 1, “Hardware”](#) – Provides hardware information such as specifications, jumper setting note and wiring.
- [Chapter 2, “Quick Start”](#) – Provides how to start an overview demo programs location, Getting Started Guide, and calibration process.
- [Chapter 3, “Magic Scan”](#) – Introduces the parameters in Magic Scan function, programming procedure, and demo programs.
- [Chapter 4, “API”](#) – Describes the diversity of naming rule for MiniOS7 and Windows platforms and functions provided in I-8014W library.
- [Chapter 5, “Troubleshooting”](#) – Provides some techniques for troubleshooting the problems faced.

Hardware

Specifications

Input Range	+/- 10 V, +/- 5 V, +/- 2.5 V, +/- 1.25 V -20 mA ~ +20 mA (Requires Optional External 125 Ohm Resistor)
Resolution	16 bits
Sampling Rate	Single Channel, Polling Mode :250K S/s
FIFO	4k sample (8 k bytes)
Accuracy	0.05 % of FSR +/- 1 LSB
Input Mode	Polling, Pacer (Magic Scan)
Magic Scan Mode	Mode1: standard mode Mode2: virtual sample and hold
Overvoltage Protection	+60 V ~ -45 V
Input Impedance	20 k, 200 k, 20 M (Jumper Select)
Intra-module Isolation, Field to Logic	2500 Vrms
LED Power Indicator	Yes
Power Consumption	2.5 W Max
Operating Temperature	-25 ~ +75 °C
Storage Temperature	-30 ~ +85 °C
Humidity	5 to 95 % RH, Non-condensing
Dimensions (W x L x H)	30 mm x 102 mm x 115 mm

Pin Assignments

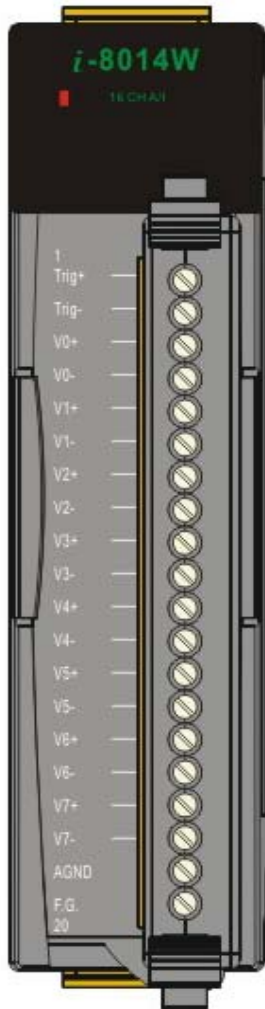

Terminal No.	Pin Assignment	
	Differential	Single-ended
01	Trig+	Trig
02	Trig-	AGND
03	V0+	V0
04	V0-	V8
05	V1+	V1
06	V1-	V9
07	V2+	V2
08	V2-	V10
09	V3+	V3
10	V3-	V11
11	V4+	V4
12	V4-	V12
13	V5+	V5
14	V5-	V13
15	V6+	V6
16	V6-	V14
17	V7+	V7
18	V7-	V15
19	AGND	AGND
20	F.G.	AGND

Jumper setting

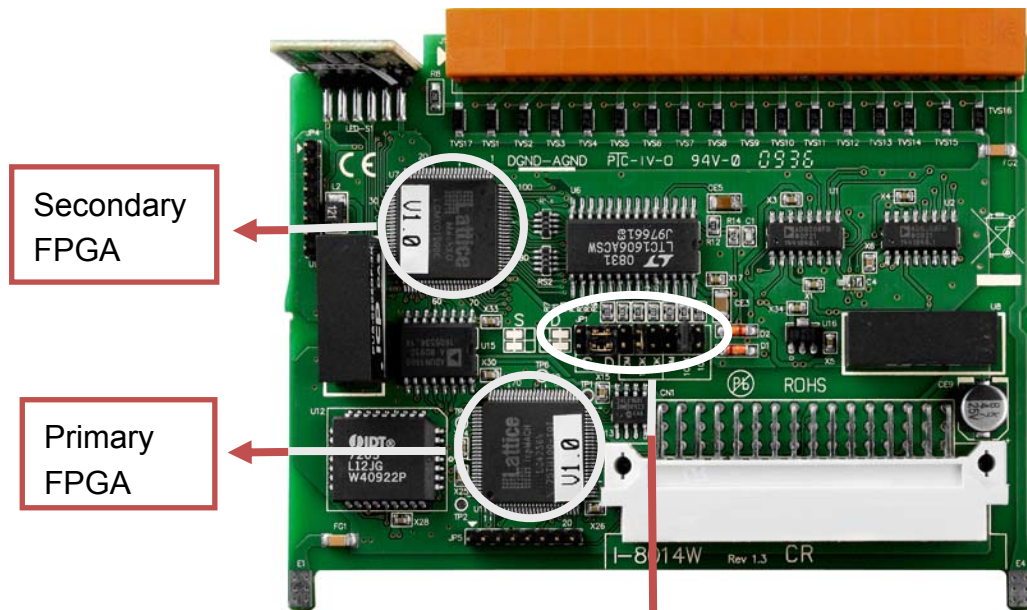

Differential / Single Ended select jumper

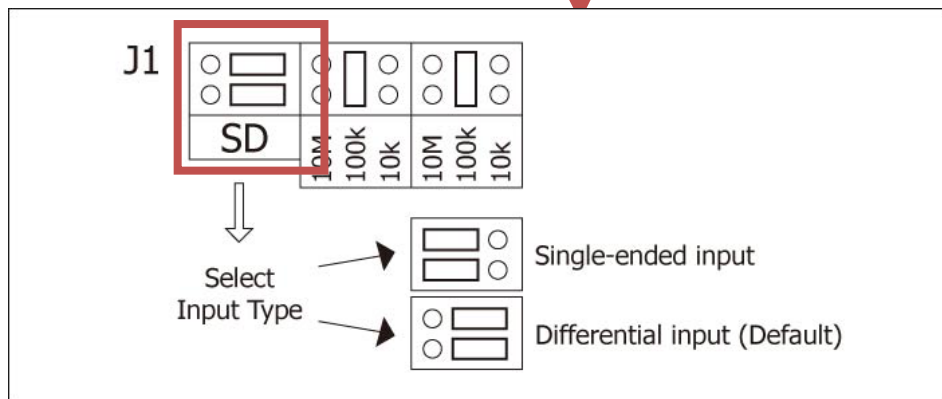

Input impedance select jumper

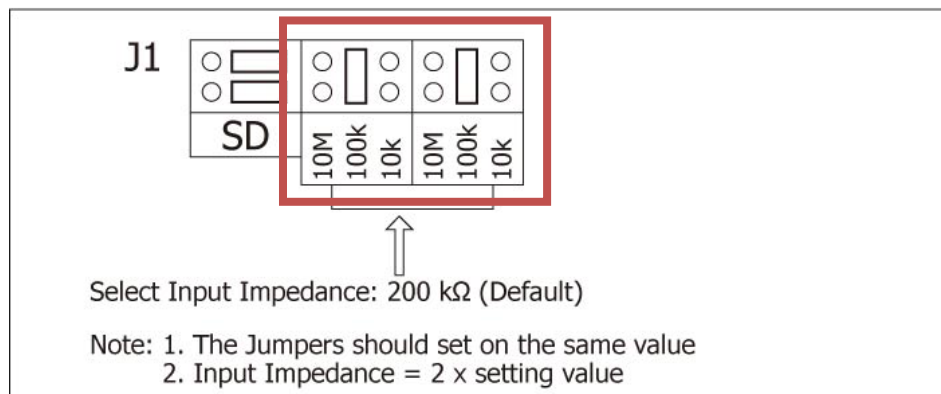

Input impedance adjustment

The I-8014W provides three input impedances such as 20k, **200k (default setting)** and 20M Ohm to meet system requirement. For most of cases, 200k is good enough.

Every time when the input impedance is changed on a calibrated module, it is necessary to calibrate the module again, refer to [Calibration, page17](#), if you are using I-8000 or iPAC-8000 (MiniOS7 platform controller); if you use WinCE or WES platform unit, refer to [page 28](#) for the calibration process.

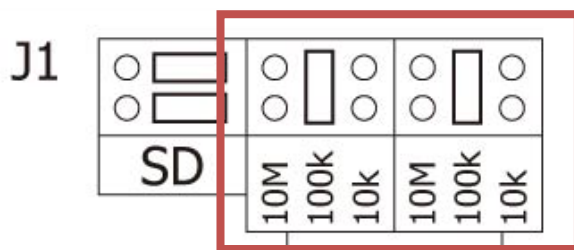

Select Input Impedance: 200 k Ω (Default)

- Note: 1. The Jumpers should set on the same value
2. Input Impedance = 2 x setting value

Wire Connection

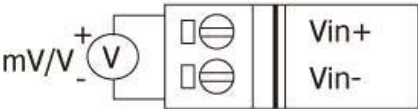
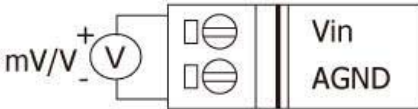
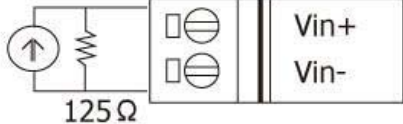
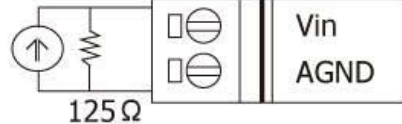
Input Type	Differential	Single-ended
Voltage Input Wiring		
Current Input Wiring		
<p>Note: When connecting to a current source, an optional external 125 Ω resistor is required.</p>		

Tips & Warnings



It is recommended to connect the V - to AGND (system ground) when measuring differential voltage inputs as the figure shows below:

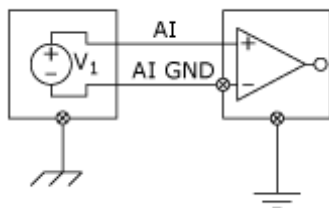

While measuring current input, it is no use to enhance to accuracy.

Block Diagram

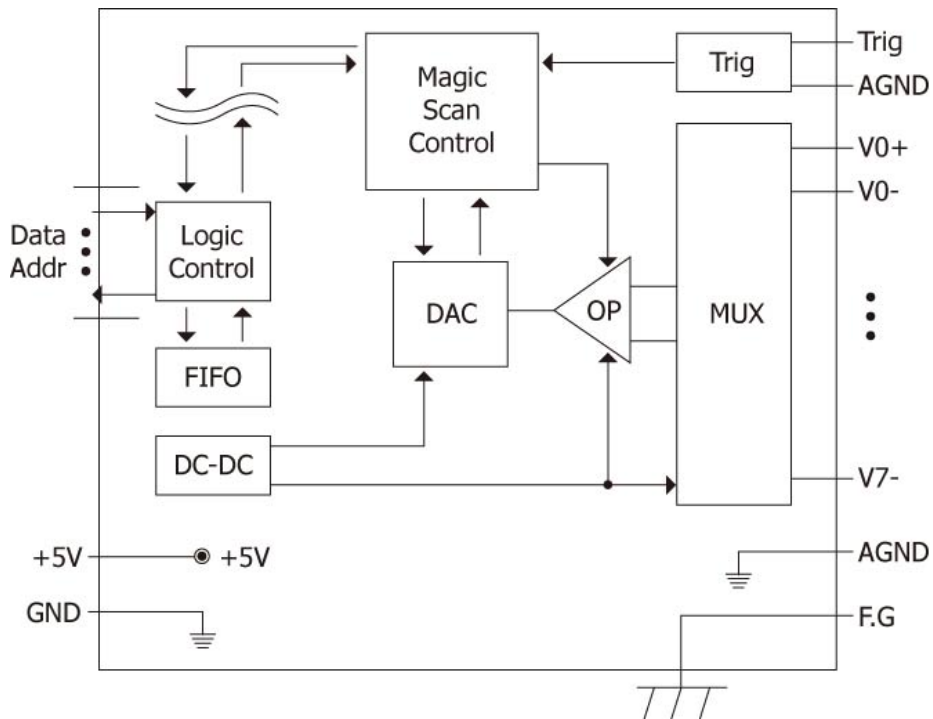

Demo Programs Location

The following table lists the location of I-8014W demo programs for different platform for verifying the functions of the I-8014W and reusing the source code if needed.

Platform	Location
For I-8000 on Web	
Library	ftp://ftp.icpdas.com/pub/cd/8000cd/napdos/8000/841x881x/demo/lib/
Demo	ftp://ftp.icpdas.com/pub/cd/8000cd/napdos/8000/841x881x/demo/io_in_slot/
For I-8000 on CD	
Library	CD:\Napdos\8000\841x881x\demo\Lib
Demo	CD:\Napdos\8000\841x881x\demo\IO_in_Slot
For iPAC-8000 on Web	
Library	ftp://ftp.icpdas.com/pub/cd/8000cd/napdos/ipac8000/demo/basic/ip-84x1_ip-88x1/lib/
Demo	ftp://ftp.icpdas.com/pub/cd/8000cd/napdos/ipac8000/demo/basic/ip-84x1_ip-88x1/io_in_slot/
For iPAC-8000 on CD	
Library	CD:\Napdos\iPAC8000\Demo\Basic\iP-84x1_iP-88x1\Lib
Demo	CD:\Napdos\iPAC8000\Demo\Basic\iP-84x1_iP-88x1\IO_in_Slot
For Windows CE5 on Web	
Library	ftp://ftp.icpdas.com/pub/cd/winpac/napdos/wp-8x4x_ce50/sdk/io_modules/
Demo	ftp://ftp.icpdas.com/pub/cd/winpac/napdos/wp-8x4x_ce50/demo/winpac/evc/pac_io/local/ (eVC demo) ftp://ftp.icpdas.com/pub/cd/winpac/napdos/wp-8x4x_ce50/demo/winpac/dotnet/c%23.net/pac_io/local/ (C# demo)

Platform	Location
For Windows CE5 on CD	
Library	CD:\napdos\wp-8x4x_ce50\sdk\IO_Modules
Demo (eVC & C#)	CD:\napdos\wp-8x4x_ce50\Demo\WinPAC\eVC\PAC_IO\Local CD:\napdos\wp-8x4x_ce50\Demo\WinPAC\DOTNET\C#.NET\PAC_IO\Local
For Windows CE6 on Web	
XP-8000 -CE6	ftp://ftp.icpdas.com/pub/cd/xp-8000-ce6/sdk/special_io/ ftp://ftp.icpdas.com/pub/cd/xp-8000-ce6/demo/xpac/vc2008/io/local/ ftp://ftp.icpdas.com/pub/cd/xp-8000-ce6/demo/xpac/c%23/io/local/
XP-8000 -Atom-CE6	ftp://ftp.icpdas.com/pub/cd/xpac-atom-ce6/sdk/special_io/ ftp://ftp.icpdas.com/pub/cd/xpac-atom-ce6/demo/xpac/vc2008/io/local/ ftp://ftp.icpdas.com/pub/cd/xpac-atom-ce6/demo/xpac/c%23/io/local/
For Windows CE6 on CD	
XP-8000 -CE6	CD:\SDK\Special_IO CD:\Demo\XPAC\VC2008\IO\Local CD:\Demo\XPAC\C#\IO\Local
XP-8000 -Atom-CE6	CD:\SDK\Special_IO CD:\Demo\XPAC\VC2008\IO\Local CD:\Demo\XPAC\C#\IO\Local
For Windows Embedded Standard on Web	
XP-8000	ftp://ftp.icpdas.com/pub/cd/xp-8000/sdk/io/ ftp://ftp.icpdas.com/pub/cd/xp-8000/demo/specialized_io/
XP-8000 -Atom	ftp://ftp.icpdas.com/pub/cd/xpac-atom/sdk/io/ ftp://ftp.icpdas.com/pub/cd/xpac-atom/demo/specialized_io/
For Windows Embedded Standard on CD	
XP-8000	CD:\SDK\IO CD:\Demo\Specialized_IO
XP-8000 -Atom	CD:\SDK\IO CD:\Demo\Specialized_IO

Quick Start

This section gives the getting started guide and calibration process for using I-8014W on MiniOS7 and Windows platforms individually.

This section contains getting started guide and calibration process for using I-8014W:

- [On MiniOS7 platform controller, page 14](#) (i-8000 and iPAC-8000 unit)
- [On Windows platform controller, page 26](#) (WinCE and WES unit)

On MiniOS7 platform controller

This section contains

- [Getting Started Guide, page 14](#)
- [Calibration, page 17](#)

Getting Started Guide

The executable file AI_INFO.EXE in basic_info folder of I-8014W demo could be used to get the basic information of the I-8014W and verify the AI read function. The basic information includes:

- Version number and published date of library.
- FPGA version
- The Single-ended/ differential jumper setting position
- The gain and offset values for every input range
- The data read on each channel

(See [Demo Programs Location, page 12](#) , to get AI_INFO.EXE in I-8014W demo program)

Step 1. Refer to [Jumper setting, page 8](#), make sure the Differential / Single Ended select jumper is in differential position.

Step 2. Connect your stable signal source (ex. a battery output) to I-8014W by differential wiring as below.

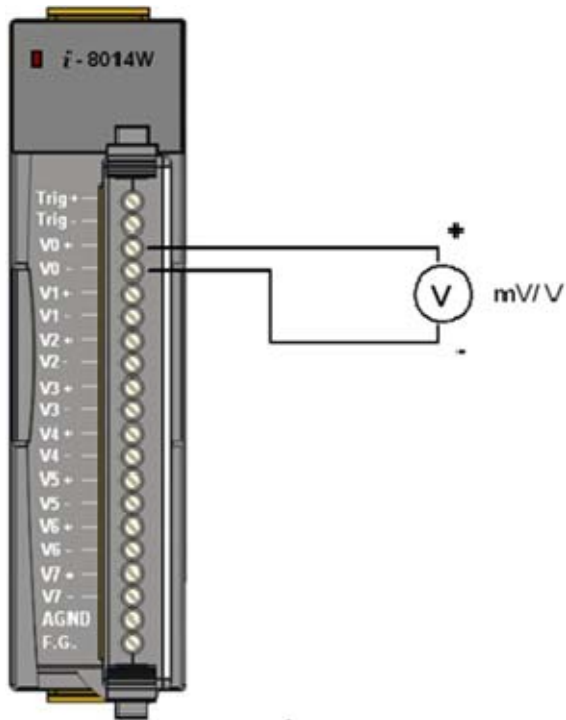

Step 3. Connect the power supply to the unit, and connect the control unit and PC by RS232 cable.

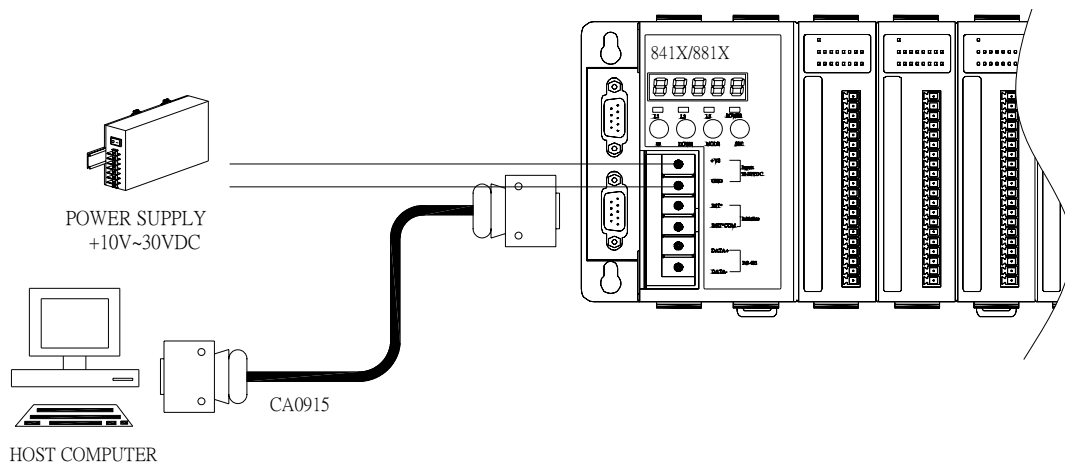

Step 4. Launch AI_INFO.EXE on PC, verify the basic information and AI read from each channel as follows:

Tips & Warnings



Unused channel should be connected to GND to avoid floating.

```
This demo show how to use i8014W_ReadAI to read hex and float format analog input data.
There is an i8014 at slot 0
*****
Primary FPGA Version =: 0001
Secondary FPGA Version =: 0002
Library Version =: 1005
Build Date =: Jul 20 2010
*****
i8014W Input Mode=Differential

Select 0 : +/-10V
Select 1 : +/-5V
Select 2 : +/-2.5V
Select 3 : +/-1.25V
Select 4 : +/-20mA
Select Gain <0~4>:0
Select Gain[0]=+/-10V ,the Calibrated Gain= 32833, Calibrated Offset= -39

[00]=[2.6645 ]
[01]=[2.6642 ]
[02]=[2.6639 ]
[03]=[2.6639 ]
[04]=[2.6642 ]
[05]=[2.6639 ]
[06]=[2.6642 ]
[07]=[2.6642 ]
```

Library and FPGA version information
Single-ended/ differential jumper position

Gain value is around 33000, when it is far from 33000 means that the value is incorrect.

Verify the AI data from each channel.

Calibration

Every one of I-8014W is factory calibrated and well verified. Usually, it is unnecessary to calibrate the module, unless the input impedance is changed on a calibrated module, or the accuracy is lost.

To calibrate the I-8014W, in addition to plugging the I-8014W in the slot of controller, the following items are needed:

- One stable calibration source such as 3 1/2 digit power supplier (or better) or a battery output.
- One 4 1/2 digit voltage meter (15-bit resolution or better)
- Calibration Program: see [page 12](#) to get the demo program located in I-8014W demo program.

Tips & Warnings



1. An unstable calibration source will cause the calibration fault and affect the data acquisition accuracy.
 2. If you would like to calibrate ± 20 mA, select ± 2.5 V instead, the two types use the same gain and offset values.
 3. The calibration program use channel 0 to accept calibration source only.
-

This section contains:

- [To calibrate the I-8014W on i-8000 and iPAC-8000 unit, page 18](#)
- [To verify the calibration, page 24](#)
- [To recover default calibration settings, page25](#)

To calibrate the I-8014W on i-8000 and iPAC-8000 unit

Step 1. Repeat from step1 to step3 in [Quick Start](#) (See [page 14](#))

- a. Wire the power to control unit and control unit to PC.
- b. Set the Differential / Single Ended jumper in differential position and wire the calibration source to **channel 0** by differential wiring.
- c. Connect the meter as the following figure shows.
- d. Turn on the control unit.

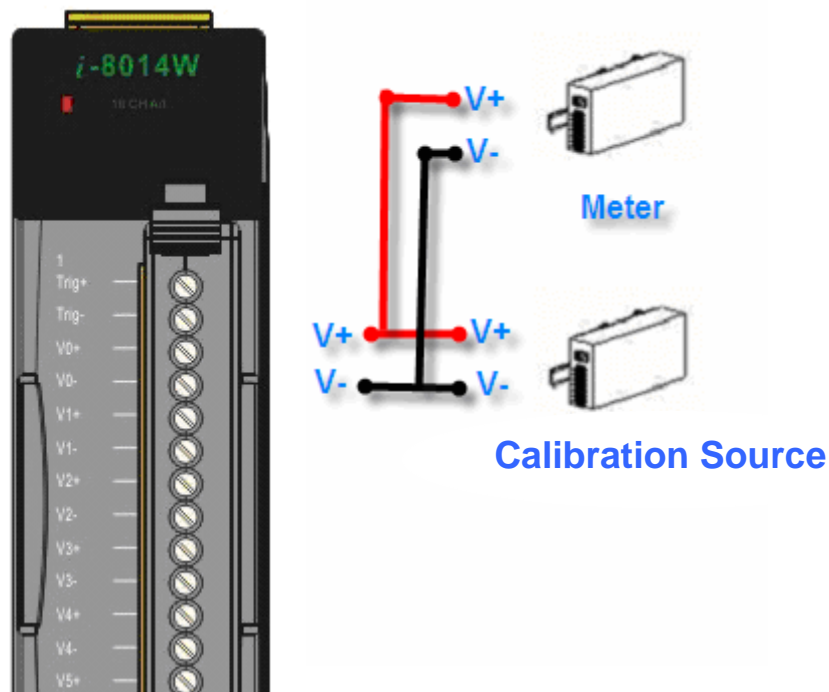

Step 2. Launch MiniOS7 Utility on PC, download the calibration program to the control unit and run it.

The MiniOS7 Utility could be downloaded from the following web site. Select the proper calibration program for your controller.

- MiniOS7 Utility: <http://www.icpdas.com/download/minios7.htm>
- 8014cal.exe: the calibration program for I-8000 unit, located at the same folder as I-8014W demo programs. (See [Demo Programs Location](#), page 12)
- iP_8014cal.exe: the calibration program for iP-8000 unit, located at the same folder as I-8014W demo programs. (See [Demo Programs Location](#), page 12)

a. Launch MiniOS7 Utility on PC, choose connection → New connection.

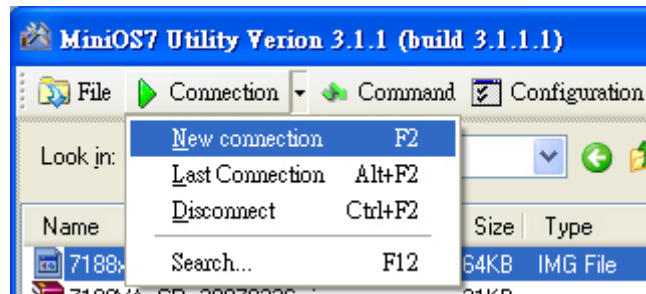

b. Select the COM port on PC connected to the control unit from the drop-down list, configure the communication parameters as follows, and click **OK**.

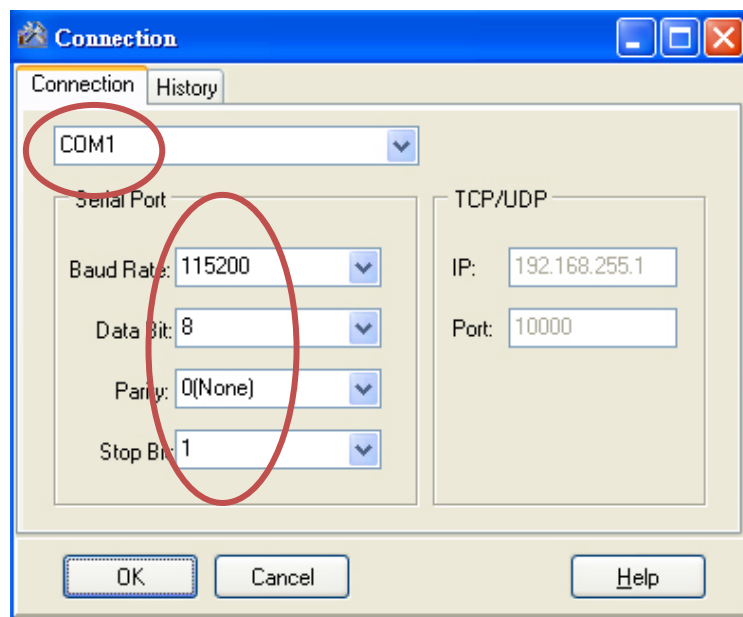

c. Highlight the calibration program and click **Upload**.

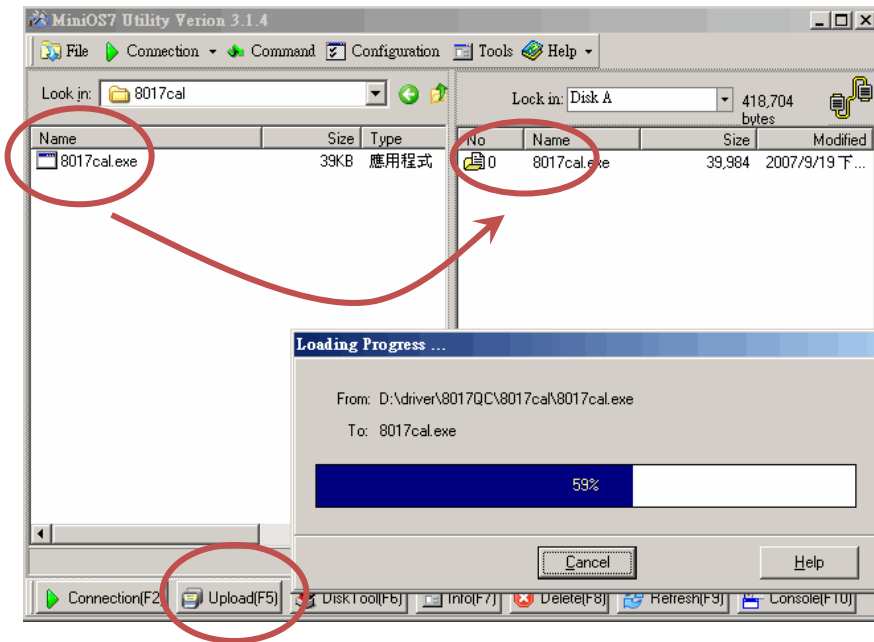

d. Right-click the updated calibration file and choose Run

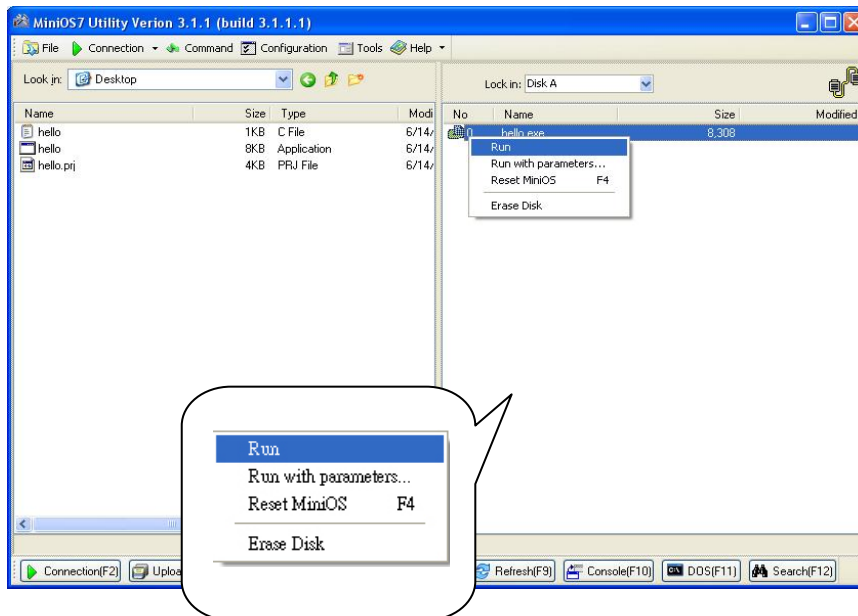

The calibration program in control unit runs and on PC the 7188xw.exe runs to provide a command line interface.

```
7188XW 1.31 [COM1:115200,N,8,1],FC=0,CTS=1, DIR=D:\temp
now baudrate = 115200!
i8K_UDP>run #1
8017 Found in slot2
*****
* Calibration program for 8017H/8017HS *
* *
* Lattice Firmware Version = 4 *
* Please connect a voltage signal *
* to ch0 of the 8017H/8017HS first. *
* ver 1.0.1 _ Oct 08 2007 by Martin *
*****
* <0>Calibrate Gain_0 -10.00U to +10.00U *
* <1>Calibrate Gain_1 - 5.00U to + 5.00U *
* <2>Calibrate Gain_2 - 2.50U to + 2.50U *
* <3>Calibrate Gain_3 - 1.25U to + 1.25U *
* <r>Recover default calibration settings *
* <t>Read calibrated AI value of Ch0 *
* <s>Show calibrated Gain/Offset parameters *
* <q>quit *
*****
Please choose (<0~3,r,t,s,q>):
```

Step 3. Calibrate the I-8014W.

- a. Select an input type from 0 ~ 3.

```
7188XW 1.31 [COM1:115200,N,8,1],FC=0,CTS=1, DIR=D:\temp
* <0>Calibrate Gain_0 -10.00U to +10.00U *
* <1>Calibrate Gain_1 - 5.00U to + 5.00U *
* <2>Calibrate Gain_2 - 2.50U to + 2.50U *
* <3>Calibrate Gain_3 - 1.25U to + 1.25U *
* <r>Recover default calibration settings *
* <t>Read calibrated AI value of Ch0 *
* <s>Show calibrated Gain/Offset parameters *
* <q>quit *
*****
Please choose (<0~3,r,t,s,q>):0
Original Gain_0=34074 Offset_0=-74
Please input 1st voltage (<0.0~+10.0>):8.003
Point 1=(0517 Hex)
Please input 2nd voltage (<0.0~-10.0>):-8.003
Point 2=(FB0D Hex)
New Gain= 36110 ,Offset=-366 ,Save to EEPROM ? <y/n>:y
Gain0 is calibrated.
```

- b. Determine two values (points) in the range of the selected input type for calibration process.

For example, after selecting 0 (-10V ~ +10V), we would like to use +8V and -8V as the two calibration points.

- c. Make calibration source output one of the two points (ex. 8V)



- d. Enter the value read by meter at the input 1st voltage prompt in the console and press Enter.



```

7188XW 1.31 [COM1:115200,1],FC=0,CTS=1, DIR=D:\temp
* <0>Calibrate Gain_0 -10.000 to +10.000 *
* <1>Calibrate Gain_1 - 5.000 to + 5.000 *
* <2>Calibrate Gain_2 - 2.500 to + 2.500 *
* <3>Calibrate Gain_3 - 1.250 to + 1.250 *
* <r>Recover default calibration settings *
* <t>Read calibrated AI value of Ch0 *
* <s>Show calibrated Gain/Offset parameters *
* <q>quit *
*****
Please choose <0~3,r,t,s,q>:0

Original Gain_0=34074 Offset_0=-74
Please input 1st voltage <0.0~+10.0>:8.003
Point 1=<0517 Hex>
Please input 2nd voltage <0.0~-10.0>:-8.003
Point 2=<FB00 Hex>
New Gain= 36110 ,Offset=-366 ,Save to EEPROM ? <y/n>:y
Gain0 is calibrated.
  
```

e. Make the calibration source output the other point - 8V.

f. Enter the value read by meter at the input 2nd voltage prompt and press **Enter**

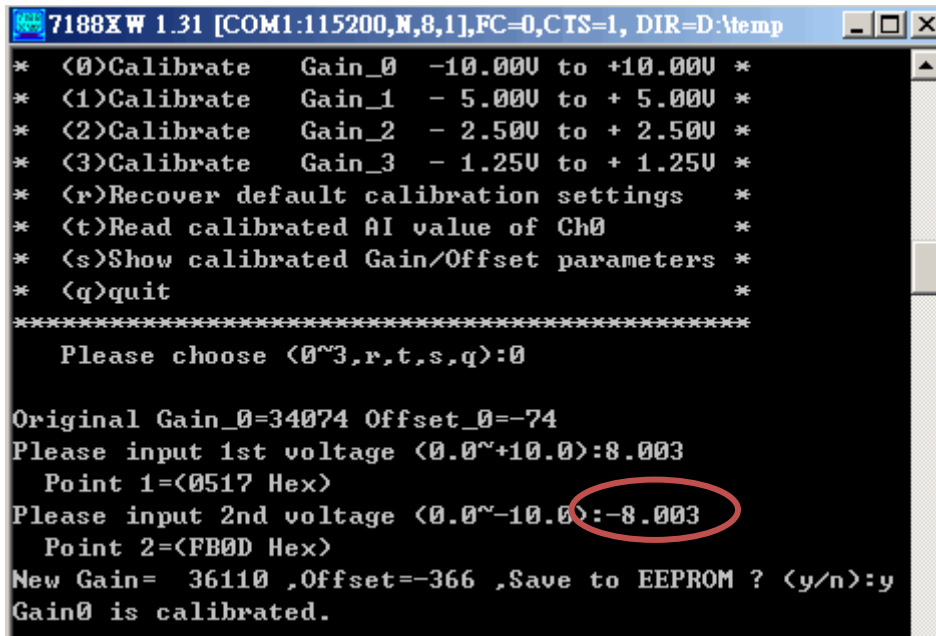

```
7188XW 1.31 [COM1:115200,N,8,1],FC=0,CTS=1, DIR=D:\temp
* <0>Calibrate Gain_0 -10.000 to +10.000 *
* <1>Calibrate Gain_1 - 5.000 to + 5.000 *
* <2>Calibrate Gain_2 - 2.500 to + 2.500 *
* <3>Calibrate Gain_3 - 1.250 to + 1.250 *
* <r>Recover default calibration settings *
* <t>Read calibrated AI value of Ch0 *
* <s>Show calibrated Gain/Offset parameters *
* <q>quit *
*****
Please choose <0~3,r,t,s,q>:0

Original Gain_0=34074 Offset_0=-74
Please input 1st voltage <0.0~+10.0>:8.003
Point 1=(0517 Hex)
Please input 2nd voltage <0.0~-10.0>:-8.003
Point 2=(FB0D Hex)
New Gain= 36110 ,Offset=-366 ,Save to EEPROM ? (y/n):y
Gain0 is calibrated.
```

The console displays new gain and offset values for this calibration as:

New Gain= 3xxxx, Offset= nnn, Save to EEPROM? (y/n):

g. Enter **y** and press **Enter** to accept the values and save to EEPROM

The calibration for -10V ~ +10V is complete.

To verify the calibration

Step1. Make the calibration source output a voltage to channel 0 of I-8014W.

For example, -2V,

Step2. In the same console of calibration program, enter **t** (Read calibrated AI value of Ch0) and select the input type which is just calibrated (ex. 0, -10 V ~10V).

Step3. Confirm the data read from channel 0.

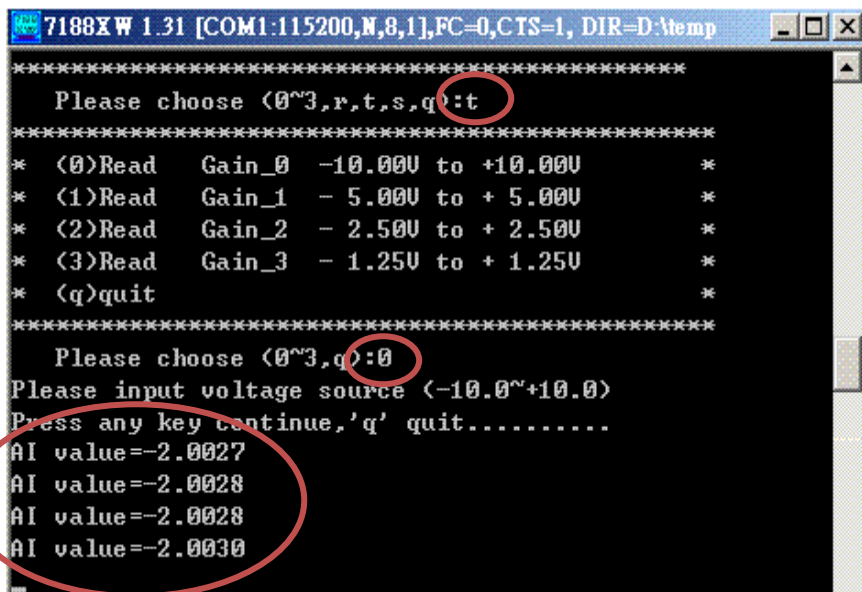

```
7188X W 1.31 [COM1:115200,N,8,1],FC=0,CTS=1, DIR=D:\temp
*****
Please choose (0^3,r,t,s,q):t
*****
* (0)Read   Gain_0  -10.00V to +10.00V   *
* (1)Read   Gain_1   - 5.00V to + 5.00V   *
* (2)Read   Gain_2   - 2.50V to + 2.50V   *
* (3)Read   Gain_3   - 1.25V to + 1.25V   *
* (q)quit                                     *
*****
Please choose (0^3,q):0
Please input voltage source (-10.0~+10.0)
Press any key continue, 'q' quit.....
AI value=-2.0027
AI value=-2.0028
AI value=-2.0028
AI value=-2.0030
```

To recover default calibration settings

For 200k Ohm (default setting) input impedance, the calibration program provides **(r)** **Recover default calibration settings** function to recover the gain and offset values to factory default.

```
7188XW 1.31 [COM1:115200,N,8,1],FC=0,CTS=1, DIR=C:\Program...
+/- 10U      Gain =34074 Offset =-74
+/- 5U       Gain =34072 Offset =-76
+/- 2.5U     Gain =34069 Offset =-84
+/- 1.25U    Gain =34054 Offset =-79
+/- 20mA     Gain =34069 Offset =-84

Gain/Offset parameters which in using
+/- 10U      Gain =31383 Offset =-64
+/- 5U       Gain =31359 Offset =-68
+/- 2.5U     Gain =34069 Offset =-84
+/- 1.25U    Gain =34054 Offset =-79
+/- 20mA     Gain =34069 Offset =-84

*****
* (0)Calibrate Gain_0 -10.00U to +10.00U *
* (1)Calibrate Gain_1 - 5.00U to + 5.00U *
* (2)Calibrate Gain_2 - 2.50U to + 2.50U *
* (3)Calibrate Gain_3 - 1.25U to + 1.25U *
* (r)Recover default calibration settings *
* (t)Read calibrated AI value of Ch0 *
* (s)Show calibrated Gain/Offset parameters *
* (q)quit *
*****
Please choose (0~3,r,t,s,q):r

Backup default Gain/Offset parameters settings for 100K
+/- 10U      Gain =34074 Offset =-74
+/- 5U       Gain =34072 Offset =-76
+/- 2.5U     Gain =34069 Offset =-84
+/- 1.25U    Gain =34054 Offset =-79
+/- 20mA     Gain =34069 Offset =-84

Gain/Offset parameters which in using
+/- 10U      Gain =34074 Offset =-74
+/- 5U       Gain =34072 Offset =-76
+/- 2.5U     Gain =34069 Offset =-84
+/- 1.25U    Gain =34054 Offset =-79
```

On Windows platform controller

This section contains:

- [Getting Started Guide, page 26](#)
- [Calibration, page 28](#)

Getting Started Guide

The executable file **pac_i8014W_BasicInfo.exe** in BasicInfo folder of I-8014W demo could be used to get the basic information of the I-8014W and verify the AI read function. The basic information includes:

- Version number and published date of library.
- FPGA version
- The Single-ended/ differential jumper setting position
- The gain and offset values for every input range
- The data read on each channel

(See [Demo Programs Location, page 12](#), to get pac_i8014W_BasicInfo.exe in I-8014W demo program)

Step1. Refer to [Jumper setting, page 8](#), make sure the Differential / Single Ended select jumper is in differential position.

Step2. Connect your stable signal source (ex. a battery output) to I-8014W by differential wiring.

Step3. Plug the I-8014W into the slot of

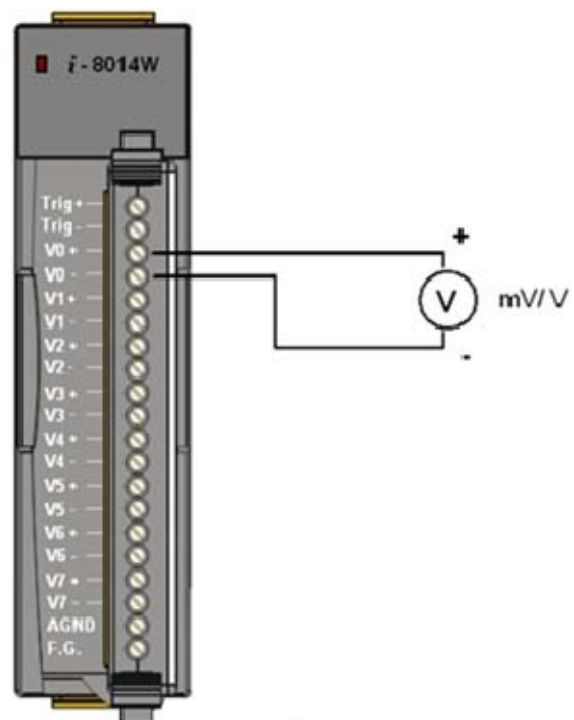

control unit and turn on the controller.

Step4. Launch **pac_i8014W_BasicInfo.exe** on controller, and verify the basic information and AI read from each channel as follows:

Tips & Warnings



Unused channel should be connected to GND to avoid floating.

Library and FPGA version information
Single-ended/ differential jumper position

Gain value is around 33000, when it is far from 33000 means that the value is incorrect.

Verify the AI data from each channel.

Calibration

Every one of I-8014W is factory calibrated and well verified. Usually, it is unnecessary to calibrate the module, unless the input impedance is changed on a calibrated module, or the accuracy is lost.

To calibrate the I-8014W, in addition to plugging the I-8014W in the slot of controller, the following items are needed:

- One stable calibration source such as 3 1/2 digit power supplier (or better) or a battery output.
- One 4 1/2 digit voltage meter (15-bit resolution or better)
- Calibration Program: see [page 12](#) to get the demo program located in I-8014W demo program.

Tips & Warnings



- 1: An unstable calibration source will cause the calibration fault and affect the data acquisition accuracy.
 - 2: If you would like to calibrate ± 20 mA , select ± 2.5 V instead, the two types use the same gain and offset values..
 - 3: The calibration program use channel 0 to accept calibration source only.
-

This section contains:

- [To calibrate the I-8014W on WinCE and WES unit, page 29](#)
- [To verify the calibration, page 33](#)
- [To recover default calibration settings, page 34](#)

To calibrate the I-8014W on WinCE and WES unit

Step1. Refer to [Jumper setting, page 8](#), make sure the Differential / Single Ended select jumper is in differential position.

Step2. Connect your calibration source to channel 0 of I-8014W by differential wiring.

Step3. Plug the I-8014W into the slot of controller and turn on the controller.

Step4. Launch `pac_i8014W_Calibration.exe` on controller.

(In the `c#` demos for I-8014W, see [Demo Programs Location, page 12 and 13](#))

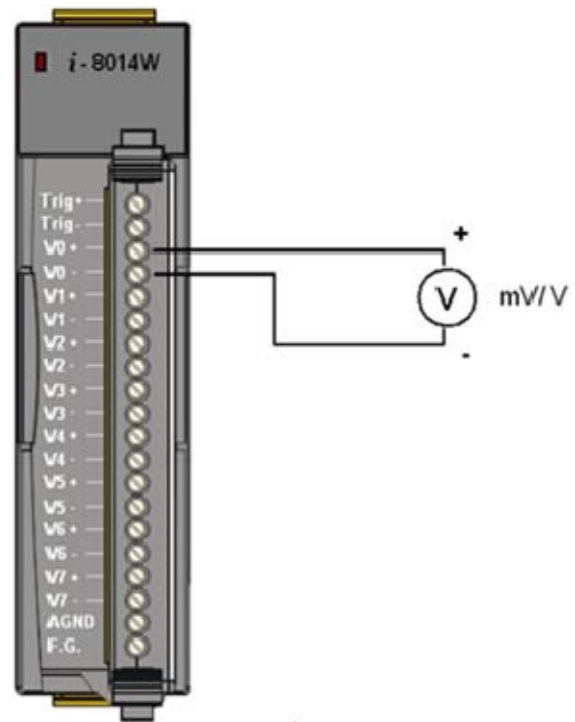

Tips & Warnings



Only channel 0 is valid to perform calibration

Step5. Select the I-8014W slot number and input range from the drop-down list located in the upper part of the window.

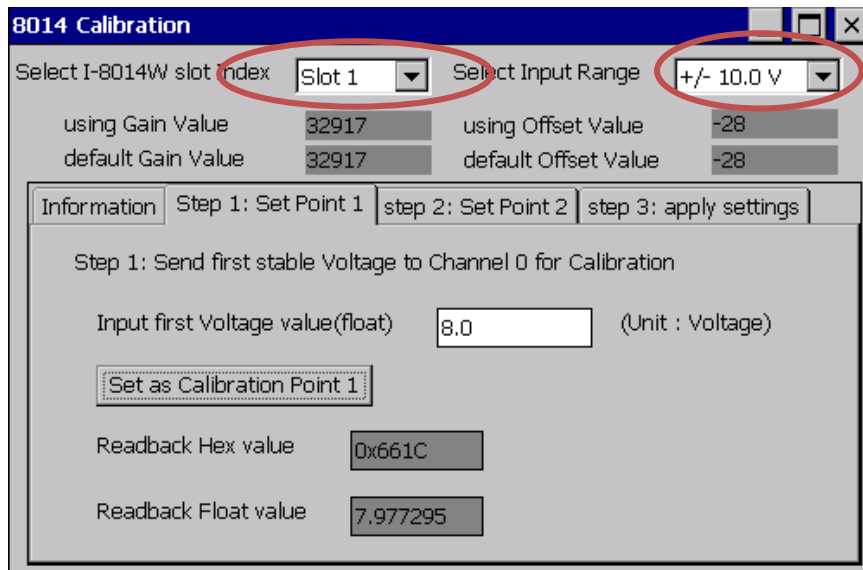

Step6. Determine two values (points) in the range of the selected input type for calibration process.

For example, after selecting 0 (-10V ~ +10V), we would like to use +8V and -8V as the two calibration points:

Step7. Make calibration source output one of the two points (ex. 8V)



Step8. Click the **Step1. Set point 1** tab, enter the value read by meter (ex. 8.0), and click **Set as Calibration Point 1**.

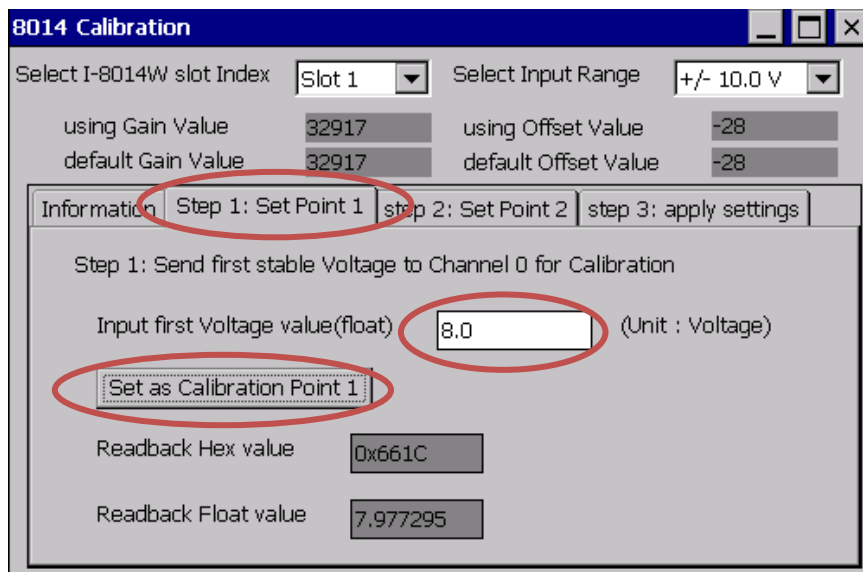

Step9. Make calibration source output the other value (ex. - 8V)

Step10. Click the **Step2. Set point 2** tab, enter the value read by meter (ex. - 8.0), and click **Set as Calibration Point 2**.

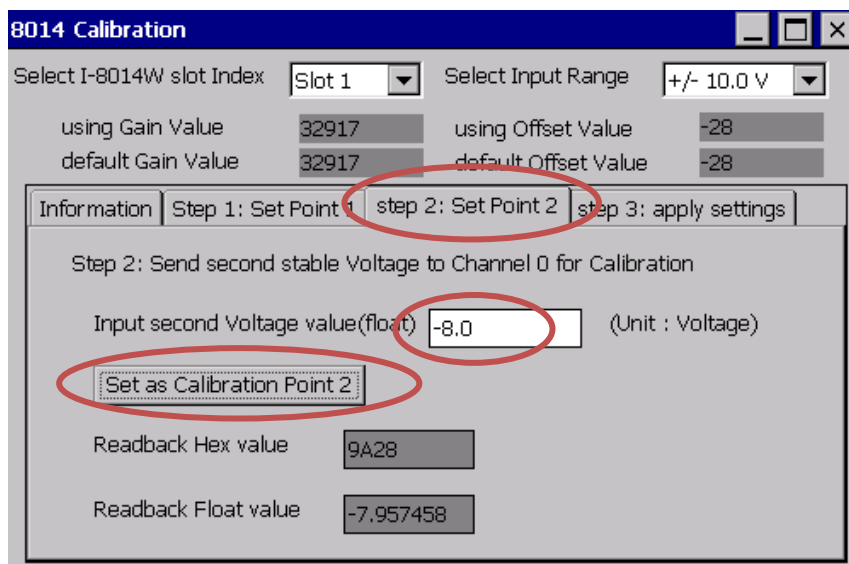

Step11. Click the **Step3. apply settings** tab, click **Save new calibration settings**.

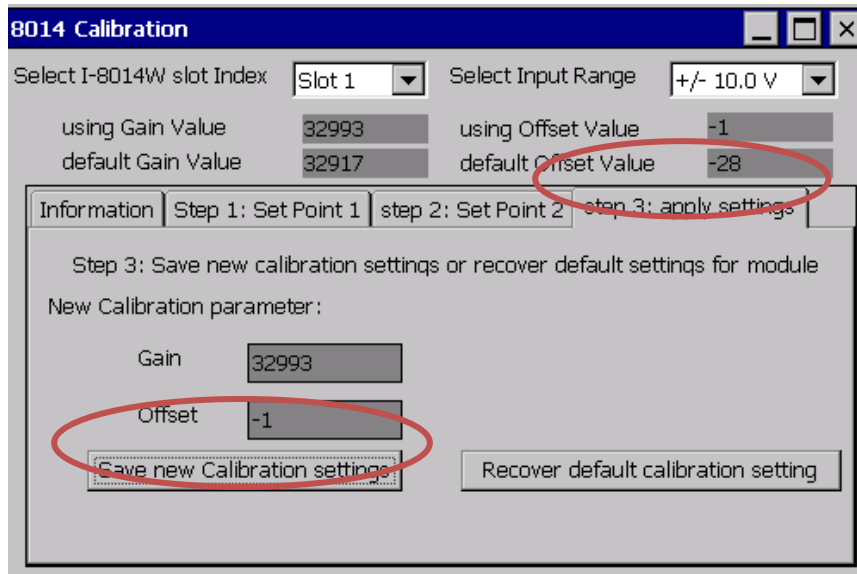

The calibration for -10V ~ +10V is complete.

To verify the calibration

Step1. Make the calibration source output a voltage to channel 0 of I-8014W.

For example, -2V,

Step2. Click the **Step1. Set point 1** tab, confirm the AI read back as following:

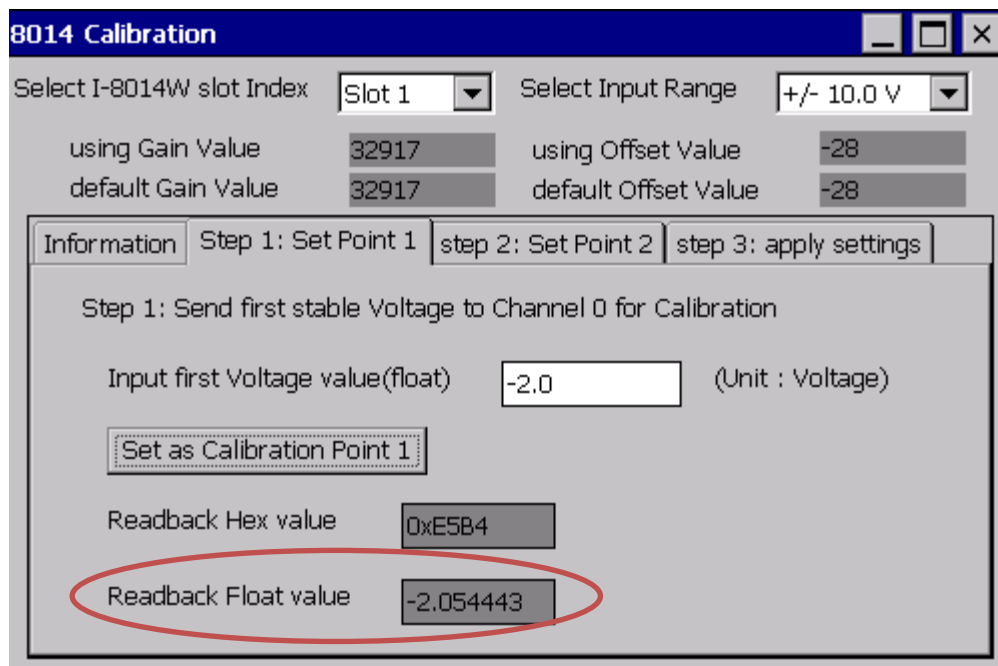

The screenshot shows the '8014 Calibration' software window. At the top, there are two dropdown menus: 'Select I-8014W slot Index' set to 'Slot 1' and 'Select Input Range' set to '+/- 10.0 V'. Below these are four text input fields: 'using Gain Value' (32917), 'using Offset Value' (-28), 'default Gain Value' (32917), and 'default Offset Value' (-28). A tabbed interface is visible with four tabs: 'Information', 'Step 1: Set Point 1', 'step 2: Set Point 2', and 'step 3: apply settings'. The 'Step 1: Set Point 1' tab is active, displaying the instruction 'Step 1: Send first stable Voltage to Channel 0 for Calibration'. Below this, there is a text input field for 'Input first Voltage value(float)' containing '-2.0' and '(Unit : Voltage)'. A button labeled 'Set as Calibration Point 1' is positioned below the input field. Further down, there are two more text input fields: 'Readback Hex value' containing '0xE5B4' and 'Readback Float value' containing '-2.054443'. The 'Readback Float value' field is circled in red.

To recover default calibration settings

For 200k Ohm (default setting) input impedance, the calibration program provides **Recover default calibration settings** function to recover the gain and offset values to factory default:

Click the **Step3. apply settings** tab , and click the **Recover default calibration setting** button.

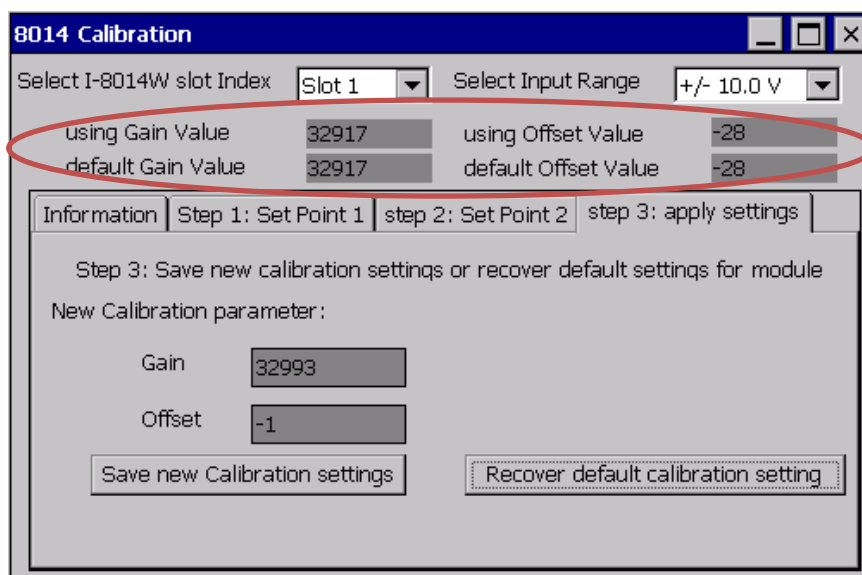
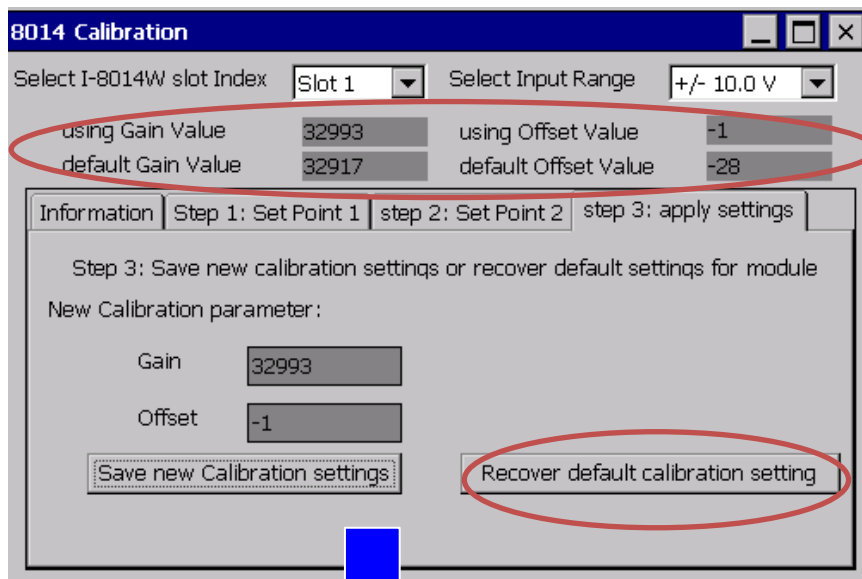

Magic Scan

This chapter provides the detail of Magic Scan, the key function designed on the I-8014W for multi-channel high sampling rate analog data acquisition.

At the last part of this chapter, it introduces two demo programs for implementing Magic Scan. Both the Magic Scan mode and trigger method could be selected in the two programs, the only difference is that one transfers data by polling and the other transfers data by interrupt.

This chapter contains:

- [Magic Scan modes, page 36](#)
- [Trigger methods for the Magic Scan, page 39](#)
- [Magic Scan Example, page 44](#), -- introduces the two data transfer modes for the Magic Scan

Magic Scan Mode

For multi-channel high speed data acquisition system, the I-8014W provides up to 250 kHz sampling rate and 4k sample FIFO to reduce the loading of CPU and advance the performance of your system.

The following table describes the specification of Magic Scan:

Max. channel	Sampling rate	FIFO	Sampling mode	Trigger method	Transfer data mode
16	2Hz ~ 250 kHz	4k sample	- standard - virtual sample and hold	-software -internal hardware -external hardware	- polling - interrupt

This section describes the two Magic Scan modes in which the I-8014W might use:

- [Standard mode, page 37](#)
- [Virtual sample and hold mode, page 38](#)

Standard mode

It converts one data from one channel at every sampling occasion.

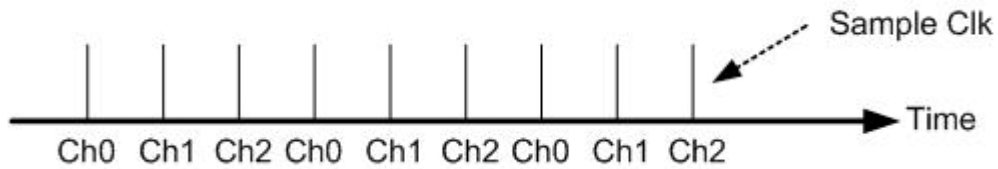

For example, if the Ch0, Ch1 and Ch2 are configured into the scan function, and sampling rate is set as 1 kHz, the time period between every sampling operation is 1 ms, and scan one cycle (from Ch0 to Ch1 to Ch2) needs 3ms as below:

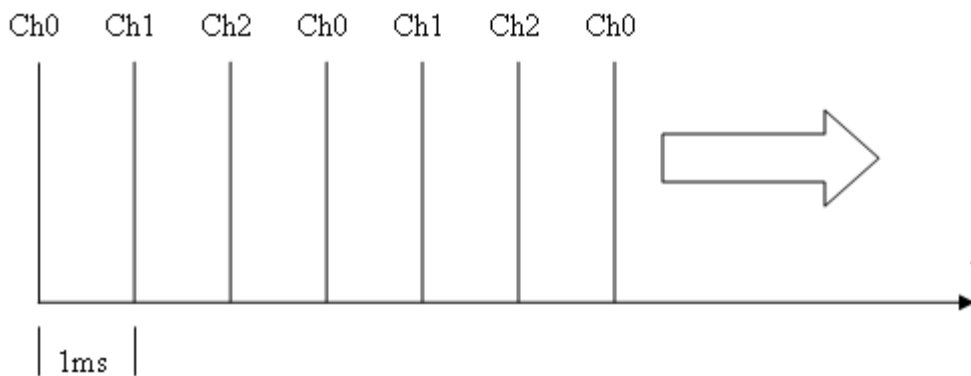

Virtual sample and hold mode

Virtual sample and hold works like that the several channels set into the scan function are sampled at the same time; actually, the sampling rate is 250 kHz , and the scan cycle time is the period for the sampling rate you set into the Magic Scan.

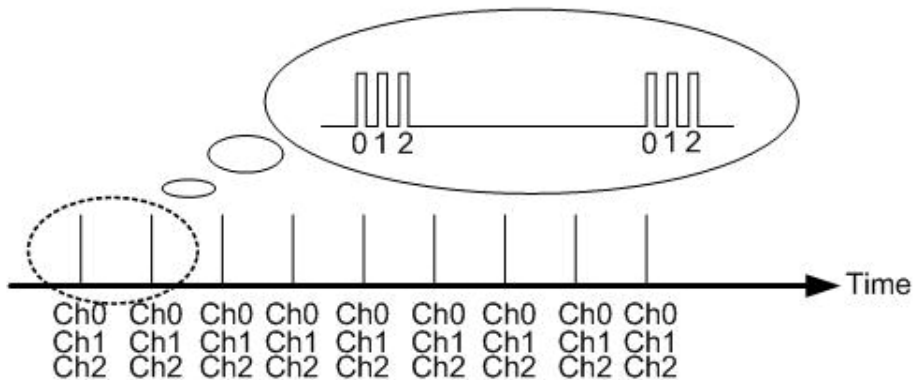

For example, if you set the sampling rate as 1 kHz and configure Ch0, Ch1, and Ch2 into the scan function, the sampling rate for scanning Ch0 to Ch2 is 250 kHz, and the frequency of scan cycle is 1 kHz, therefore, the time used between one scan cycle to the next is 1 ms.

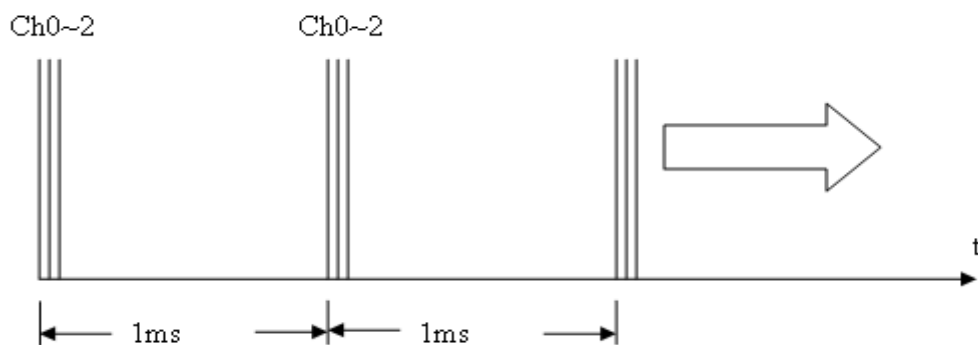

Trigger method

This section contains:

- [Software trigger method, page 39](#)
- [Internal hardware trigger method, page 40](#)
- [External hardware trigger method, page 41](#)

Software trigger method

The API provides a trigger instruction to start Magic Scan. If you have two or more modules, you need to configure the Magic Scan parameters to each module and execute the Magic Scan instruction to the modules **one by one**.

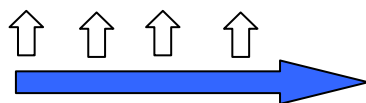

Start Magic Scan from one module to next by software instruction.

Internal hardware trigger method

If you would like to synchronously start the Magic Scan function on two or more modules, you can set the trigger source as the internal hardware signal in program, and the internal trigger signal will trigger the Magic Scan operation almost at the same time for the several modules.



Trigger the Magic Scan for each module by internal hardware signal.

External hardware trigger method

The Magic Scan also accepts external trigger source from the first two terminals, and with this trigger method, you can set it as rising edge triggered or falling edge triggered. After setting the external trigger source, triggering condition and starting the Magic Scan in program, the I-8014W will wait unless it receive the external form Trig+ and Trig- terminals and then start the Magic Scan.

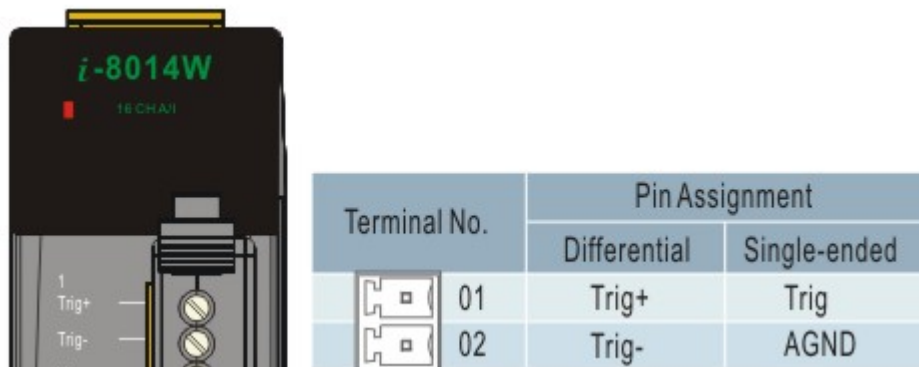

FIFO

The I-8014W is equipped with a 4 k sample of FIFO which may store 4096 samples of data from Magic Scan to guarantee no data loss. The acquisition data is saved into the FIFO one by one in the scan process. We have to read back data from the FIFO in time to avoid FIFO filled; if the FIFO is filled, the data can not be saved again until a FIFO clear command is executed. On the other hand, if we read data from FIFO too frequently, it will waste CPU time and reduce the performance. To get the best balance, we provide two modes to transfer data from FIFO, one is by polling and the other is by interrupt.

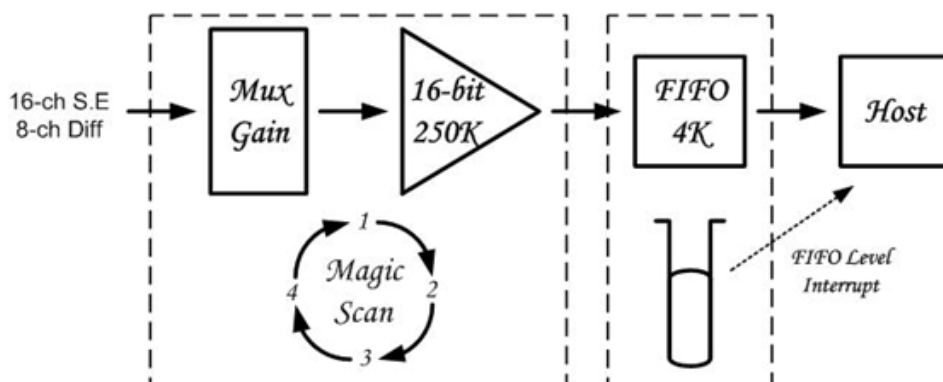

Magic Scan Procedure

The program procedure is illustrated as below:

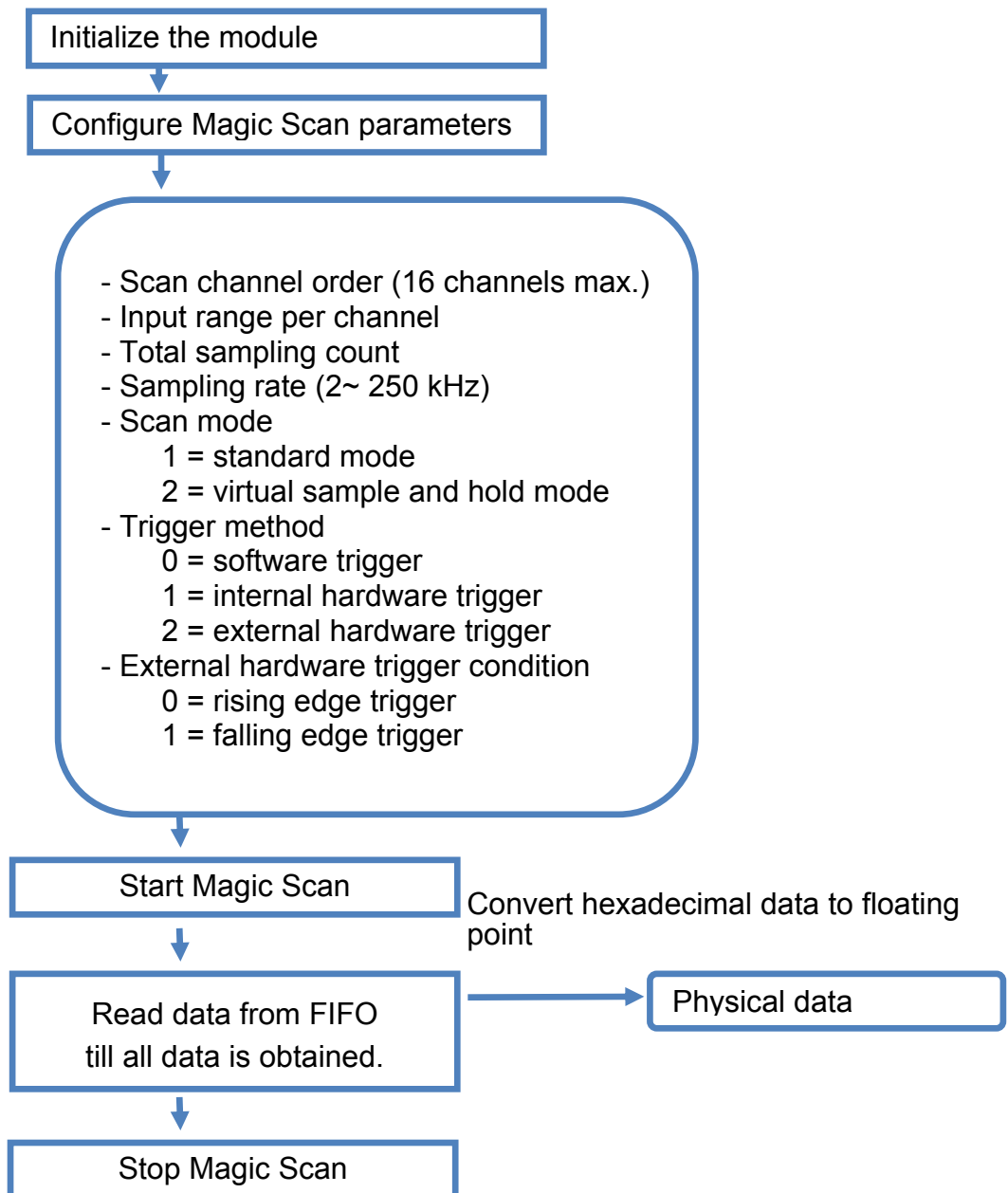

Magic Scan Example

This section describes two Magic Scan demo programs that use different data transfer modes. (See [Demo Programs Location, page 12](#), to get the demo program for your controller)

- [Magic.exe, page 44](#) – transfer data by polling
- [Mag_ISR.exe, page 50](#) – transfer data by interrupt

Magic.exe

This section describes the parameters that should be set in Magic.exe, and separates the description for MiniOS7 and Windows platforms.

This section contains:

- [The demo program on MiniOS7 , page 45](#)
- [The demo program on Windows platform, page 47](#)

The demo program on MiniOS7

The following figure shows the interface and parameters that should be set in Magic.exe on MiniOS7.

```

This Demo will show how to use magic scan function to read analog input
Search I-8014W ....
  There is an i8014 at slot 0
  i8014W Input Mode=Differential and can have maximum 8 analog input

Input all i8014W_ConfigMagicScan parameters :
Step 1: Define scanned channel counts for magic scan:
Input scanned channel counts (1~16) :4
Now we have scanned channel counts = 4

Step 2: Define 4 elements for channel and gain array
The Gain definition of I-8014W
  Select 0 : +/-10U
  Select 1 : +/-5U
  Select 2 : +/-2.5U
  Select 3 : +/-1.25U
  Select 4 : +/-20mA

Differential Mode range : channel 0 ~ 7
Select which Channel of Arr[0] (0~7) :0
Select which Gain of Arr[0] (0~4):0
Select which Channel of Arr[1] (0~7) :1
Select which Gain of Arr[1] (0~4):0
Select which Channel of Arr[2] (0~7) :2
Select which Gain of Arr[2] (0~4):0
Select which Channel of Arr[3] (0~7) :3
Select which Gain of Arr[3] (0~4):0

Step 3: Define Sample Rate of I-8014W
Input Sample rate of 8014W (1~2500000) :200
Note: the real sample rate may not the same as user input
the function i8014W_ConfigMagicScan return code is the
real sample rate accepted by I-8014W

Step 4: Select Scan Mode of I-8014W:
  Scan Mode 1= M1 Standart Mode
  Scan Mode 2= M2 Sample and Hold Mode
Input Scan Mode of 8014W (1 or 2) :1

Step 5: Select Trigger Source of I-8014W.
I-8014W can have 3 types of trigger source
  trigger source 0= Software Command
  trigger source 1= Internal Interrupt Signal
  trigger source 2= External Tigger Signal
Input trigger source of 8014W (0~2) :0

Step 6: Select Trigger State of I-8014W if select external
  Not external trigger source, trigger state is 0

The Magic Scan Configurations of I-8014W are:
  Scan channel count = 4
  CH[0]= 0      Gain[0]= 0 ( +/-10U )
  CH[1]= 1      Gain[1]= 0 ( +/-10U )
  CH[2]= 2      Gain[2]= 0 ( +/-10U )
  CH[3]= 3      Gain[3]= 0 ( +/-10U )
  Scan Mode = 1 ( Standard Mode )
  Trigger Source = 0 ( Software Command )
  Trigger State = 0 ( No need for External Trigger )
  Set Sample Rate = 200.000 Real Sample Rate = 200.000
Press any Key to Start magic scan
  
```

Step 1. Input total scan channel count.
(Form 1 to 16)

Step 2. Set channel number and input range for the channel.
The order of channel number inputted determines the scan order.

Step 3. Input sampling rate.

Step 4. Input the scan mode.

Step 5. Select the trigger method.

Step 6. Set the trigger condition if external trigger is selected in step 5.

The used parameters list

If scan mode is set as standard mode, the total spend time equals [1000] multiplied by [sampling period]. (1000 is the total sample count defined in demo program)

```
Press any Key to Start magic scan
Wait for Magic Scan .....

Stop magic scan and FIFO data amount = 1000
Magic scan total spend time = 4999 ms

Press 's' or 'S' to Show AI, others to next step
Start to Print all data:
Arr[0]=F[2.6645]      Arr[1]=F[2.6642]      Arr[2]=F[2.6645]      Arr[3]=F[2.6645]
Arr[0]=F[2.6642]      Arr[1]=F[2.6645]      Arr[2]=F[2.6645]      Arr[3]=F[2.6642]
Arr[0]=F[2.6642]      Arr[1]=F[2.6645]      Arr[2]=F[2.6642]      Arr[3]=F[2.6642]
Arr[0]=F[2.6642]      Arr[1]=F[2.6639]      Arr[2]=F[2.6645]      Arr[3]=F[2.6642]
Arr[0]=F[2.6639]      Arr[1]=F[2.6645]      Arr[2]=F[2.6645]      Arr[3]=F[2.6642]
Arr[0]=F[2.6645]      Arr[1]=F[2.6645]      Arr[2]=F[2.6642]      Arr[3]=F[2.6645]
Arr[0]=F[2.6642]      Arr[1]=F[2.6642]      Arr[2]=F[2.6642]      Arr[3]=F[2.6642]
Arr[0]=F[2.6642]      Arr[1]=F[2.6642]      Arr[2]=F[2.6642]      Arr[3]=F[2.6645]
```

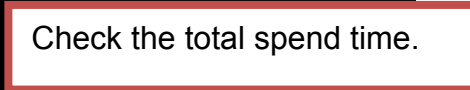

The demo program on Windows platform

The following figure shows the interface and parameters need be set in Magic.exe on Windows platform.

Step1. Select slot and input scan channel count. (From 1 to 16)

Step2. Select trigger source and input sampling rate.
If external trigger source is selected, select trigger state.

Step3. Select scan mode.

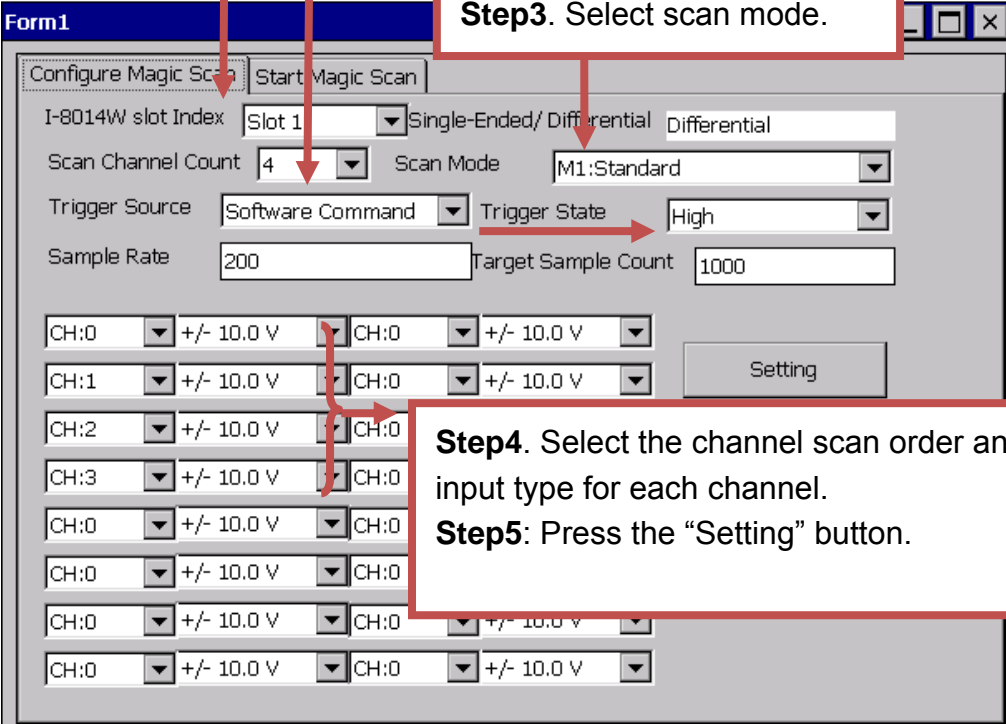

The screenshot shows the 'Form1' window for 'Configure Magic Scan'. It includes a 'Start Magic Scan' button and various configuration fields: 'I-8014W slot Index' (Slot 1), 'Single-Ended/ Differential' (Differential), 'Scan Channel Count' (4), 'Scan Mode' (M1:Standard), 'Trigger Source' (Software Command), 'Trigger State' (High), 'Sample Rate' (200), and 'Target Sample Count' (1000). Below these are eight channel settings, each with a channel ID dropdown and a voltage range dropdown (+/- 10.0 V). A 'Setting' button is located to the right of the channel settings.

Step4. Select the channel scan order and input type for each channel.

Step5: Press the "Setting" button.

Result of standard scan mode

Click the **Start Magic Scan** tag, when the sampling rate is set as 200 Hz, the sampling period is $1/200 * 1000 = 5$ ms. And spend time equals [total sample count] multiplied by [sampling period].

In this demo, the spend time 5004 ms equals to about 1000 (total sample count defined in code) times 5 (sampling period).

The screenshot shows a software window titled 'Form1' with two tabs: 'Configure Magic Scan' and 'Start Magic Scan'. The 'Start Magic Scan' tab is active. It contains several controls: a 'Start Magic Scan' button, a 'Total Scanned' field with the value '1000' and the unit 'Samples', a 'Spend Time' field with the value '5004' and the unit 'ms', and an 'Exit' button. Below these controls is a text area displaying the following information:

```
Selected Magic Scan Channel Gain Array[0] C = 0 G = 0 CH[0]= 2.600098
Selected Magic Scan Channel Gain Array[1] C = 1 G = 0 CH[1]= 2.599487
Selected Magic Scan Channel Gain Array[2] C = 2 G = 0 CH[2]= -2.600708
Selected Magic Scan Channel Gain Array[3] C = 3 G = 0 CH[3]= 2.599792
The Magic Scan Configurations of I-8014W are:
Scan channel count = 4, Total sample count =1000
CH[0]= 0 Gain[0]= 0 (+/-10V ) CH[0]= 2.599792
CH[1]= 1 Gain[1]= 0 (+/-10V ) CH[1]= 2.598877
CH[2]= 2 Gain[2]= 0 (+/-10V ) CH[2]= -2.601013
CH[3]= 3 Gain[3]= 0 (+/-10V ) CH[3]= 2.599792
Scan Mode = 1 ( M1:Standard ) CH[0]= 2.599487
Trigger Source = 0 ( Software Command ) CH[1]= 2.599487
Trigger State = 0 ( No need for External Trigger Signal ) CH[2]= -2.601013
Set Sample Rate = 200 Real Sample Rate = 200 CH[3]= 2.599792
CH[0]= 2.598877
CH[1]= 2.599487
CH[2]= -2.601318
CH[3]= 2.599182
CH[0]= 2.600098
CH[1]= 2.599792
CH[2]= -2.601013
```

Result of virtual sample and hold mode

Click the **Start Magic Scan** tag. When the sampling rate is set as 200 Hz, the period for one scan cycle is $1/200 * 1000 = 5$ ms.

The number of scan cycle = [Total sample count] / [Total scan channel count].

In this demo, the spend time 1254 ms = $(1000 / 4) * 5$

(Spend time = [scan cycle number] * [scan cycle period])

The spend time can be used to verify the sampling rate on I-8014W.

The screenshot shows a software window titled "Form1" with two tabs: "Configure Magic Scan" and "Start Magic Scan". The "Start Magic Scan" tab is active. It contains a "Start Magic Scan" button, a "Save Data to file" button, and an "Exit" button. Two input fields are present: "Total Scanned" with the value "1000" and "Samples", and "Spend Time" with the value "1254" and "ms". Below these fields is a text area displaying the following information:

```
Selected Magic Scan Channel Gain Array[0] C = 0 G = (
Selected Magic Scan Channel Gain Array[1] C = 1 G = (
Selected Magic Scan Channel Gain Array[2] C = 2 G = (
Selected Magic Scan Channel Gain Array[3] C = 3 G = (
The Magic Scan Configurations of I-8014W are:
Scan channel count = 4, Total sample count =1000
CH[0]= 0 Gain[0]= 0 ( +/-10V )
CH[1]= 1 Gain[1]= 0 ( +/-10V )
CH[2]= 2 Gain[2]= 0 ( +/-10V )
CH[3]= 3 Gain[3]= 0 ( +/-10V )
Scan Mode = 2 ( M2:Sample and Hold )
Trigger Source = 0 ( Software Command )
Trigger State = 0 ( No need for External Trigger Signal )
Set Sample Rate = 200 Real Sample Rate = 200
```

On the right side of the text area, there is a list of numerical values for each channel, such as CH[0]= 2.599792, CH[1]= 2.600403, CH[2]= -2.601624, CH[3]= 2.598267, etc.

Mag_ISR.exe

Mag_ISR.exe demonstrates how to transferring data by interrupt. By this way, the Magic scan parameters settings are identical to those in Magic.exe; (see [Magic Scan Procedure, page 43](#) and [Magic.exe, page 44](#)) the only difference is that we have to install interrupt service routine (ISR) before starting Magic Scan as:

```
i8014W_InstallMagicScanISR(slotIndex,Slot_ISR,triggerLevel);  
i8014W_StartMagicScan(slotIndex);
```

The ISR installed will handle the task when interrupt signal is arisen from FIFO, and parameter triggerLevel is for setting the interrupt condition as the follows:

triggerLevel	Data count
0	8
1	16
2	32
3	64
4	128
5	256
6	512
7	2048

If the data count in FIFO meets the condition that triggerLevel set, the interrupt signal will be arisen, and the code in ISR installed will process. Please note that you need to call clear interrupt function in ISR, otherwise the next interrupt signal will not be serviced again.

Using interrupt to transfer data could save the CPU time used to polling and waiting data from FIFO.

Case Example

The case requires:

1. Measuring 4 differential signals ranged from -10 V to 10V.
2. The sampling rate per channel is 200 Hz, and sampling time interval from one channel to the next channel is less than 10 μ s.
3. When 2000 samples of data collected every time, transfer the data through Ethernet to data center or a remote data storage disk.

To meet the requirements:

Step1. Set the jumper on I-8014W as differential input mode.

Step2. Set input channel as ch0 ~ ch3, and input range of each channel as -10 ~ 10 V.
(Gain = 0)

Step3. Set sampling rate as 200, and scan mode as mode2: virtual sample and hold mode. (With virtual sample and hold mode, and sampling time interval between one channel to another channel is 4 μ s.)

Step4. Collecting 2000 samples means collecting 500 samples per channel. (2000 divided by four channels) It needs $500 * (1/ 200 \text{ Hz}) = 2500 \text{ ms}$.

Step5. If the system uses MiniOS7 platform, both converting data from hexadecimal to floating and transferring data through Ethernet add CPU load. It is recommended to transfer the hexadecimal data to PC client and then convert them to floating data on PC.

If the system uses Windows platform, converting hexadecimal data to floating point data would not affect the CPU load. You can convert data local and then transfer the floating data through Ethernet.

Tips & Warnings



It is recommended to create several buffers to deal with the data obtained from FIFO and reuse them in process as the figure below. This allows the system has time to convert data, save and transfer them.

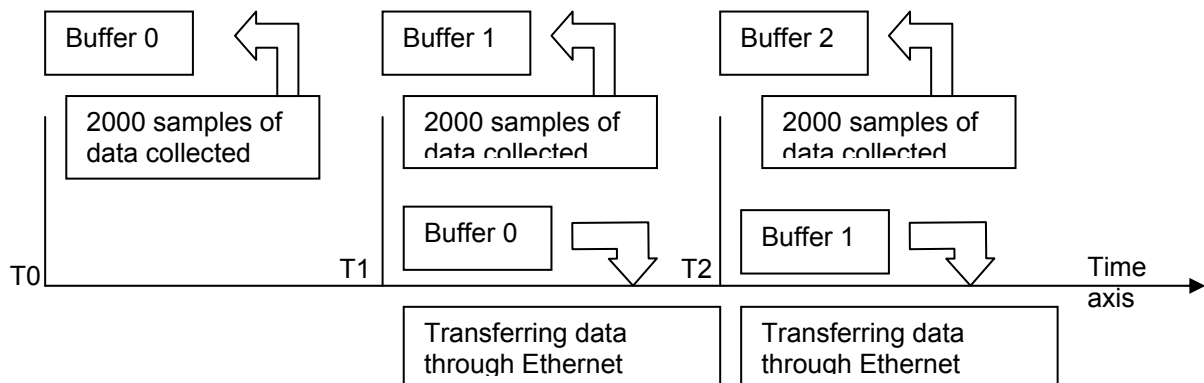

API

ICP DAS provides APIs, library and demo programs including source code for easy integration I-8014W into the following platforms. The APIs and programming procedure are similar on MiniOS7 and Windows platform, the only difference is the **prefix characters** added to the name for the functions in library (APIs). “i8014W_” is prefixed to the function name applied on MiniOS7 and Linux platform, and “pac_i8014W_” is prefixed to the functions for Windows platform.

In this manual, we use the function name on MiniOS7 platform as example and the title of the section for each function.

The following table describes the platforms and in which the product series included and the different part of function name.

Platform	Product included	API prefix characters
Windows CE5 Windows CE6	WP-8000 series WP-2000 series XP-8000-CE6 series	“pac_i8014W_”+ function name
Windows Embedded Standard (WES)	XP-8000 series	“pac_i8014W_”+ function name
MiniOS7	I-8000 series iPAC-8000 series VP-2000 series	“i8014W_” + function name
Linux	LinPAC-8000 series	“i8014W_” + function name

Function list

The following table lists the functions provided in 8014W.lib for MiniOS7 platform.

Function	Description
i8014W_Init	Initializes the driver and confirms hardware ID.
i8014W_GetFirmwareVer_L1	Gets the version number of the primary FPGA firmware for troubleshooting.
i8014W_GetFirmwareVer_L2	Gets the version number of the secondary FPGA firmware for troubleshooting.
i8014W_GetLibVersion	Gets the version number of 8014W.lib.
i8014W_GetLibDate	Gets the release date of 8014W.lib.
i8014W_GetSingleEndJumper	Gets the single-ended / differential jumper position set on the I-8014W.
i8014W_ReadGainOffset	Obtains the gain and offset values for each input type.
i8014W_ReadAI	Reads a floating point input from one specified channel.
i8014W_ReadAIHex	Reads a hexadecimal input from one specified channel.
i8014W_ConfigMagicScan	Configures all the parameters needed in Magic Scan.
i8014W_StartMagicScan	Starts Magic Scan, the data acquired will be saved into FIFO If the external trigger source is selected, the Magic Scan will wait after the function is called until the trigger signal is arrived.
i8014W_StopMagicScan	Stops Magic Scan, it also stops save data into FIFO.
i8014W_ReadFIFO	Reads a specified number of data from FIFO.
i8014W_CalibrateData	Calibrates the raw data read by Magic Scan and converts to floating point value.

Function	Description
i8014W_CalibrateDataHex	Calibrates the raw data read by Magic Scan.
i8014W_UnLockFIFO	Unlocks FIFO when it is locked because the data fills the FIFO. If the FIFO is locked, UnlockFIFO and ClearFIFO commands need be executed for the next scan.
i8014W_ClearFIFO	Clears FIFO after the UnlockFIFO function executed.
i8014W_InstallMagicScanISR	Installs ISR for interrupt events form FIFO.
i8014W_UnInstallMagicScanISR	Uninstalls Magic Scan ISR.
i8014W_ClearInt	Clears interrupt status for waiting the next interrupt event.

Error code list

Error code	Definition	Description
0	NoError	No error.
-1	ID_ERROR	Check module's ID
-2	SLOT_ERROR	Slot index (0 ~ 7)
-3	CHANNEL_ERROR	Channel index (0 ~ 15)
-4	GAIN_ERROR	Gain (0 ~ 4)
-5	FIFO_EMPTY	No data in FIFO.
-6	FIFO_LATCHED	FIFO is full and be latched
-7	FIFO_OVERFLOW	FIFO is full
-8	TX_NOTREADY	Error between primary FPGA and secondary FPGA

i8014W_Init

This function initializes the driver and confirms the hardware ID.

Prototype

For MiniOS7

```
short i8014W_Init ( int slot );
```

For Windows (CE and WES)

```
short pac_i8014W_Init( int slot );
```

Parameter

slot: 0 ~ 7

Return

0 = the module plugged in the slot is I-8014W.

-1 = there is no I-8014W module in this slot.

For other returned value, see [Error code list, page 55](#).

Note

Before you start to run any function for I-8014W, the initial function need be executed once for one I-8014W. If you have two or more I-8014W, you need call the initial function for each I-8014W individual by passing the slot number that the I-8014W plugged in.

Example

[C/C++]

```
int slotIndex,err;
err=i8014W_Init(slotIndex);
if(err==0)
{
    Print("There is an I-8014W at slot %d\n",slotIndex);
}
else
{
    Print("There is no I-8014W at slot %d\n",slotIndex);
}
```

i8014W_GetFirmwareVer_L1

This function gets the version number of the primary FPGA firmware. It is for troubleshooting or recording only.

Prototype

For MiniOS7

```
short i8014W_GetFirmwareVer_L1(int slot);
```

For Windows (CE and WES)

```
short pac_i8014W_GetFirmwareVer_L1(int slot);
```

Parameter

slot: 0 ~ 7

Return

The i8014W version number of the primary FPGA firmware

Example

[C++]

```
short ver_L1=0, slot=0;  
  
ver_L1= i8014W_GetFirmwareVer_L1 (slot);  
  
Print( "\nPrimary FPGA Version =:  
%04X",i8014W_GetFirmwareVer_L1(slot) );
```

i8014W_GetFirmwareVer_L2

This function gets the version number of the secondary FPGA firmware. It is for troubleshooting or recording only.

Prototype

For MiniOS7

```
short i8014W_GetFirmwareVer_L2(int slot);
```

For Windows (CE and WES)

```
short pac_i8014W_GetFirmwareVer_L2(int slot);
```

Parameter

slot: 0 ~ 7

Return

The I-8014W version number of the secondary FPGA firmware

Example

[C++]

```
short ver_L2=0, slot=0;

ver_L2= i8014W_GetFirmwareVer_L2 (slot);

Print( "\nSecondary FPGA Version =:
%04X",i8014W_GetFirmwareVer_L2(slot) );
```

i8014W_GetLibVersion

This function gets the version number of 8014W.lib. It is for troubleshooting or recording only.

Prototype

For MiniOS7

```
short i8014W_GetLibVersion(void);
```

For Windows (CE and WES)

```
short pac_i8014W_GetLibVersion(void);
```

Parameter

None

Return

The version number of 8014W.lib

Example

[C++]

```
short version;  
version = i8014W_GetLibVersion();  
Print("\nLibrary Version =: %04X",i8014W_GetLibVersion());
```

i8014W_GetLibDate

This function is used to get the release date of 8014W.lib.

Prototype

For MiniOS7

```
void i8014W_GetLibDate(char *LibDate);
```

For Windows (CE and WES)

```
void pac_i8014W_GetLibDate(char libDate[]);
```

Parameter

*LibDate: **[Output]** the release date of 8014W.lib

Return

None

Example

[C++]

```
char libDate [32];  
  
i8014W_GetLibDate(libDate);  
Print("\nBuild Date =: %s",libDate);
```

i8014W_GetSingleEndJumper

This function is used to get the single-ended / differential jumper position setting on the I-8014W. If you want to use 8-channel differential input, the jumper needs to be put in differential position; similarly, the jumper needs be put in single-ended position, then the 16-channel single-ended input works correctly.

Prototype

For MiniOS7

```
short i8014W_GetSingleEndJumper(int slot);
```

For Windows (CE and WES)

```
short pac_i8014W_GetSingleEndJumper(int slot);
```

Parameter

slot: 0 ~ 7

Return

- 0: The jumper is in differential position
- 1: The jumper is in single-ended position

Example

[C++]

```
short jumper=0, maxCh=0;

jumper = i8014W_GetSingleEndJumper(slot);
if(jumper)
{
    maxCh=16;
    Print("i8014W Input Mode=Single-End\n\r");
}
else
{
    maxCh=8;
    Print("i8014W Input Mode=Differential\n\r");
}
```

i8014W_ReadGainOffset

This function is used to obtain the gain and offset values for each input type.

The input types are numbered as:

0: +/-10 V, **1:** +/-5 V, **2:** +/-2.5 V, **3:** +/-1.25 V, **4:** +/-20 mA

Prototype

For MiniOS7

```
void i8014W_ReadGainOffset
(
    int slot, int gain, unsigned short* gainValue, short* offsetValue
);
```

For Windows (CE and WES)

```
void pac_i8014W_ReadGainOffset
(
    int slot, short gain, unsigned short* gainValue, short* offsetValue
);
```

Parameter

Slot: 0 ~ 7

Gain: specifies the input type (0 ~ 4).

0: +/-10 V, **1:** +/-5 V, **2:** +/-2.5 V, **3:** +/-1.25 V, **4:** +/-20 mA

*gainValue: **[Output]** gain value for the input range

*offsetValue: **[Output]** offset value for the input range

Return

None

Example

[C++]

```
unsigned short gVal=0;
short oVal=0;
i8014W_ReadGainOffset(slot,gain,&gVal,&oVal);
Print("\nThe Gain and Offset for Calibration is
Gain=%u; Offset=%d",gVal,oVal);
```

i8014W_ReadAI

This function is used to read a floating point input (calibrated) from one specified channel.

Prototype

For MiniOS7

```
short i8014W_ReadAI( int slot, int ch, int gain, float* fVal );
```

For Windows (CE and WES)

```
short pac_i8014W_ReadAI( int slot, short ch, short gain, float* fVal );
```

Parameter

slot: 0 ~ 7

ch: 0 ~ 7 for differential input, or 0 ~ 15 for single-ended input

gain: 0 ~ 4, sets the input range:

0: +/-10 V, **1:** +/-5 V, **2:** +/-2.5 V, **3:** +/-1.25 V, **4:** +/-20 mA

*fVal: [Output] the floating-point data

Return

0 = No Error

For other returned value, see [Error code list, page 55](#).

Example

[C++]

```
int slot,ch,gain;
float fVal=0.0;

slot = 0;
gain = 0; // "+/-10V"
for(ch=0;ch<8;ch++)
{
    i8014W_ReadAI( slot, ch, gain, & fVal);
    Print("\n[%02d]= [ %05.4f ]",ch,,fVal);
}
```

i8014W_ReadAIHex

This function is used to read a hexadecimal input (calibrated) from one specified channel.

Prototype

For MiniOS7

```
short i8014W_ReadAIHex(int slot, int ch, int gain, short* hVal);
```

For Windows (CE and WES)

```
short pac_i8014W_ReadAIHex(int slot, short ch, short gain, short* hVal);
```

Parameter

slot: 0 ~ 7

ch: 0 ~ 7 for differential input, or 0 ~ 15 for single-ended input

gain: 0 ~ 4, sets the input type:

0: +/-10 V, **1:** +/-5 V, **2:** +/-2.5 V, **3:** +/-1.25 V, **4:** +/-20 mA

*hVal: [Output] the hexadecimal data

Return

0 = No Error

For other returned value, see [Error code list, page 55](#).

Example

[C++]

```
int slot,ch,gain;
short hVal=0.0;

slot = 0;
gain = 0; // "+/-10V"
for(ch=0;ch<8;ch++)
{
    i8014W_ReadAIHex( slot, ch, gain, & hVal);
    Print("\n[%02d]= [ %04X ] ",ch,,hVal);
}
```

i8014W_ConfigMagicScan

This function is used to configure all the parameters needed in Magic Scan. It should be called before the start Magic Scan instruction.

Prototype

For MiniOS7

```
void i8014W_ConfigMagicScan  
(  
    int slot, int chArr[], int gainArr[], int scanChCount,  
    float sampleRate, int scanMode, int triggerSource,  
    int triggerState , float* realSampleRate  
);
```

For Windows (CE and WES)

```
void pac_i8014W_ConfigMagicScan  
(  
    int slot, short chArr[], short gainArr[], short scanChCount,  
    float sampleRate, short scanMode, short triggerSource,  
    short triggerState, float* realSampleRate  
);
```

Parameter

slot: 0 ~ 7

chArr[]: an array for setting the channel to scan. The channel indices define the scan order; the maximum channel number is 16.

gainArr[]: an array for setting the input type for the corresponding channel with the same index in chArr[].

0: +/-10 V, **1:** +/-5 V, **2:** +/-2.5 V, **3:** +/-1.25 V, **4:** +/-20 mA

scanChCount: the count of channels which are added in chArr[]

sampleRate: total sampling rate , 2 ~ 250 kHz

scanMode:

1: standard mode

2: virtual sample and hold mode

triggerSource:

0: software trigger

1: internal hardware trigger

2: external hardware trigger

triggerState:

0: rising edge trigger, it is valid only for external hardware trigger.

1: falling edge trigger, it is valid only for external hardware trigger.

*realSampleRate: **[Output]** the real sampling rate that the I-8014W used

Return

None

Example

[C++]

```
int slot, chArr[16], gainArr[16], scanChCount;
float sampleRate, realsampleRate;
int scanMode, triggerSource, triggerState;
slot = 0;
chArr[0]=0; // element 0 assigned channel 0
chArr[1]=1;
...
chArr[15]=15; // element 15 assigned channel 15
gainArr[0]=0; // element 0 assigned Input range 0
gainArr[1]=1; // element 1 assigned Input range 1
...
gainArr[15]=4; // element 15 assigned Input range 4
scanChCount=1; //only sample chArr[0] (channel 0 )
sampleRate=25000.0; //set Sample rate 25 KHz
scanMode=1; // use M1 standard mode
triggerSource=1; // use internal interrupt signal Mode
triggerState=0;

realsampleRate=i8014W_ConfigMagicScan(slotIndex,chArr,gainArr,scanCh
Count, sampleRate, scanMode,triggerSource,triggerState);
Print ("Set Sample Rate = %6.3f   Real Sample Rate = %6.3f
\n",sampleRate, realsampleRate);

i8014W_StartMagicScan(slot);
...
i8014W_ReadFIFO();
// Detail reviews i8014W_ReadFIFO section
```

i8014W_StartMagicScan

This function is used to start Magic Scan. While Magic scan starts, the data converted is saved into FIFO immediately. When external hardware trigger is selected, the I-8014W will wait after this function executed till it receives the trigger signal.

If you would like to start Magic Scan on more than one I-8014W simultaneously by internal hardware trigger source, configure each module and execute StartMagicScan function once, the argument slot could be any one slot number of those modules plugged in.

Prototype

For MiniOS7

```
short i804W_StartMagicScan (int slot);
```

For Windows (CE and WES)

```
short pac_i8014W_StartMagicScan(int slot);;
```

Parameter

slot: 0 ~ 7

Return

0 = No Error

For other returned value, see [Error code list, page 55](#).

Example

[C++]

```
int slot;  
slot=0;  
i804W_StartMagicScan(slot);
```

i8014W_StopMagicScan

This function is used to stop Magic Scan; the operation of saving data into FIFO is also stopped because no data is converted again.

Prototype

For MiniOS7

```
short i804W_StopMagicScan (int slot);
```

For Windows (CE and WES)

```
short pac_i8014W_StopMagicScan(int slot);
```

Parameter

slot: 0 ~ 7

Return

0 = No Error

For other returned value, see [Error code list, page 55](#).

Example

[C++]

```
int slot;  
slot = 0;  
i804W_StopMagicScan (slot);  
//Detail reviews i804W_ReadFifo section
```

i8014W_ReadFIFO

This function is used to read data from FIFO after Magic Scan triggered. If the data in FIFO is less than argument readCount, the function will read back all the data and return immediately, you need to call this function again and reset argument hexData [] and readCount, till all the data required is obtained and then stop the Magic Scan.

Prototype

For MiniOS7

```
short i804W_ReadFIFO  
(  
    int slot, short hexData[], short readCount,  
    short* dataCountFromFIFO  
);
```

For Windows (CE and WES)

```
short pac_i8014W_ReadFIFO  
(  
    int slot, short hexData[], short readCount,  
    short* dataCountFromFIFO  
);
```

Parameter

Slot: 0 ~ 7

hexData []: the start address of data array to store data read back with hexadecimal format

readCount: the count of data required

* dataCountFromFIFO: **[Output]** the count of data read back in this process.

Return

0 = No Error

For other returned value, see [Error code list, page 55](#).

Example

[C++]

```
int slot;
short hexData[8192];
long readCnt=0;
short totalScaned=0;
short TargetCnt=1000;
slot = 0;
i8014W_ReadFIFO(slot,hexData+totalScaned,
TargetCnt-totalScaned,&readCnt);
if(readCnt>0)
totalScaned+=readCnt;
if(readCnt==MAX_FIFO || totalScaned>=TargetCnt)
{
i8014W_StopMagicScan(slot);
i8014W_UnLockFIFO(slot);
i8014W_ClearFIFO(slot);
}
```

i8014W_CalibrateData

This function is used to calibrate the raw data read in Magic Scan process and convert to floating point value.

Prototype

For MiniOS7

```
void i8014W_CalibrateData  
(  
    int slot, short iGain, short dataFromFIFO, float* calibratedAI  
);
```

For Windows (CE and WES)

```
void pac_i8014W_CalibrateData  
(  
    int slot, short iGain, short dataFromFIFO, float* calibratedAI  
);
```

Parameter

Slot: 0 ~ 7

iGain: 0 ~ 4, sets the input type:

0: +/-10 V, **1:** +/-5 V, **2:** +/-2.5 V, **3:** +/-1.25 V, **4:** +/-20 mA

dataFromFIFO: the raw data read from FIFO

* calibratedAI : **[Output]** the floating point value.

Return

None

Example

[C++]

```
int slot;
int i;
float calibratedAI=0;
printf("Start to Print all data:\n\n\r");
for(i=0;i<totalScaned;i++);
{
    slot = 0;
    i8014W_CalibrateData (slotIndex,
    gainArr[i %scanChCount],hexData[i], & calibratedAI);
    printf("Arr[%d]=[%5.4f]\t",i%scanChCount,calibratedAI);
}
```

i8014W_CalibrateDataHex

This function is used to calibrate the raw data read in Magic Scan process.

Prototype

For MiniOS7

```
void i8014W_CalibrateDataHex  
(  
    int slot, short iGain, short dataFromFIFO, short* calibratedAI  
);
```

For Windows (CE and WES)

```
void pac_i8014W_CalibrateDataHex  
(  
    int slot, short iGain, short dataFromFIFO, short* calibratedAI  
);
```

Parameter

Slot: 0 ~ 7

iGain: 0 ~ 4, sets the input type:

0: +/-10 V, **1:** +/-5 V, **2:** +/-2.5 V, **3:** +/-1.25 V, **4:** +/-20 mA

dataFromFIFO: the raw data read from FIFO

* calibratedAI : **[Output]** the calibrated hexadecimal value.

Return

None

Example

[C++]

```
int slot;
int i;
float calibratedAI=0;
printf("Start to Print all data:\n\n\r");
for(i=0;i<totalScaned;i++);
{
    slot = 0;
    i8014W_CalibrateDataHex (slotIndex,
    gainArr[i %scanChCount],hexData[i], & calibratedAI);
    printf("Arr[%d]=[%#x]\t",i%scanChCount,calibratedAI);
}
```

i8014W_UnLockFIFO

This function is used to unlock FIFO when the FIFO locked because of filled. Keep the FIFO unlocked and cleared before the next Magic Scan starting.

Prototype

For MiniOS7

```
void i804W_UnLockFIFO (int slot);
```

For Windows (CE and WES)

```
void pac_i8014W_UnLockFIFO(int slot);;
```

Parameter

slot: 0 ~ 7

Return

None

Example

[C++]

```
int slot;  
slot = 0;  
i804W_UnLockFIFO (slot);  
//Detail reviews i804W\_ReadFIFO section
```

i8014W_ClearFIFO

This function is used to clear FIFO after the UnlockFIFO function executed. Keep the FIFO unlocked and cleared before the next Magic Scan starting.

Prototype

For MiniOS7

```
void i804W_ClearFIFO (int slot);
```

For Windows (CE and WES)

```
void pac_i8014W_ClearFIFO(int slot);;
```

Parameter

slot: 0 ~ 7

Return

None

Example

[C++]

```
int slot;  
slot = 0;  
i804W_ClearFIFO (slot);  
//Detail reviews i804W\_ReadFIFO section
```

i8014W_InstallMagicScanISR

This function is used to Install ISR for interrupt events form FIFO. Since the count of data in FIFO is more than the definition of argument triggerLevel set (as table below), the interrupt event occurs and the ISR executes to serve the event. In ISR, use **ReadFIFO** to transfer data from FIFO and **ClearInt** to clear the interrupt status.

Prototype

For MiniOS7

```
short i804W_InstallMagicScanISR  
(  
    int slot, void (*isr)(int slot), int triggerLevel  
);
```

For Windows (CE and WES)

```
short pac_i8014W_InstallMagicScanISR  
(  
    int slot, void(*isr)(int slot), short triggerLevel  
);
```

Parameter

slot: 0 ~ 7

*isr (int slot): the function pointer passed for ISR

triggerLevel: 0 ~ 7, it is used to set the interrupt trigger condition based on the count of data in FIFO. If the argument is set more than 7, it will be coerced to 7.

If the number of data in FIFO is more than the condition that triggerLevel set, the interrupt will be triggered and the ISR executes to handle the interrupt.

The following table lists the definition of triggerLevel:

triggerLevel	Data count
0	8
1	16
2	32
3	64
4	128
5	256
6	512
7	2048

Return

0 = No Error

For other returned value, see [Error code list, page 55](#).

Example

[C++]

```
void main()
{
    int slot,TrgLevel;
    slot = 0;
    TrgLevel=100;
    i8014W_Install_MagicScanISR(slot,ISRFUN, TrgLevel);
    i8014W_ConfigMagicScan(...);
    // Detail reviews i8014W_ConfigMagicScan section
    i8014W_StartMagicScan(slot);
    ...
    while(1)
    {
        if(IntCnt>1)
        {
            i8014W_UnInstall_MagicScanISR(slot);
            break;
        }
    }
    ...
}
void ISRFUN(int slot);
{
    Int IntCnt=0;
    IntCnt++;
    ret=i8014W_ReadFIFO(slot, hexData+totalScaned,
    TargetCnt-totalScaned,&readCnt);
    if(readCnt >0)
    {
        totalScaned+=readCnt;
        printCom1("TotalScaned= %d\n\r",totalScaned);
        totalRead+=readCnt;
    }
    i8014W_ClearInt(slot);
}
```

i8014W_UnInstallMagicScanISR

This function is used to uninstall the Magic Scan ISR.

Prototype

For MiniOS7

```
short i804W_UnInstallMagicScanISR(int slot);
```

For Windows (CE and WES)

```
short pac_i8014W_UnInstallMagicScanISR(int slot);
```

Parameter

slot: 0 ~ 7

Return

0 = No Error

For other returned value, see [Error code list, page 55](#).

Example

[C++]

```
int slot;  
slot = 0;  
i804W_UnInstallMagicScanISR (slot);  
// Detail reviews i8014W_Install_MagicScanISR section
```

i8014W_ClearInt

This function is used to clear the Magic Scan interrupt. In ISR, it should be called to clear the triggered status for dealing with the next interrupt event.

Prototype

For MiniOS7

```
void i804W_ClearInt (int slot);
```

For Windows (CE and WES)

```
void pac_i8014W_ClearInt(int slot);
```

Parameter

slot: 0 ~ 7

Return

None

Example

[C++]

```
int slot;  
slot = 0;i804W_StopMagicScan (slot);  
// Detail reviews i8014W_Install_MagicScanISR section
```

Troubleshooting

This chapter discusses how to solve the problem you may meet.

This chapter contains:

- How to verify the AI function on WinCE or WES unit? (See [page 88](#))
- Service-request requirement (See [page 92](#))
- Why does the data read from I-8014W seem unstable? (See [page 92](#))
- How to solve FIFO LATCHED error (-6)? (See [page 933](#))

How to verify the AI function on WinCE or WES unit?

If the data read from the I-8014W is inconsistent with the input signal, and you would like to confirm the input function, `pac_i8014W_Utility.exe` may help you. The utility is for using I-8014W on **WinCE and WES controller only** and is located in the I-8014W C # demo program for the controller. (See [Demo Programs Location, page 12](#))

Step1. Wire a stable signal to I-8014W.

- a. Wire your input signal according to the Differential or single-ended Jumper setting. (See [Jumper setting, page 8](#))
- b. The input range could be from +10V to -10V.
- c. Plug the I-8014W on the slot of your controller and turn on the Windows platform controller.

Tips & Warnings



1. A battery output could provide a stable enough signal.
2. A 125 Ohm resistance is required when measuring current input.
3. In voltage measurement with differential input type, if the result is not stable as the input signal, it is recommended to wire Vn- and AGND (analog ground pin) additional to enhance the accuracy. When measuring current input, it is no use to enhance to accuracy.

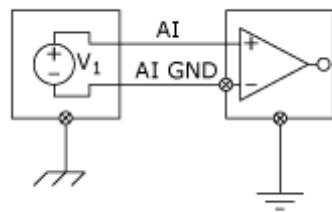

Step2. Launch pac_i8014W_Utility.exe

Step3: Read the information in I-8014W.

- a. Form the I-8014W slot index drop-down list, select the slot in which the I-8014W is plugged.
- b. Click the **Basic Information** tag.

The Basic Information page includes:

- the version of 8014W.lib, primary FPGA firmware (Firmware 1), secondary FPGA firmware (Firmware 2)
- the position of single-ended/ differential jumper set
- the gain and offset values for each input type

Click **Save** to save all the information to Slot1_8014W_Info.txt file. It is useful for troubleshooting when a service is requested.

Single-Ended/ Differential	Gain	Offset
+/- 10V	32833	-39
+/- 5V	32831	-43
+/- 2.5V	32826	-52
+/- 1.25V	32665	-51
+/- 20mA	32826	-52

Verifying the gain and offset value

The gain value is around 33000, if it is far from 33000 meaning that the value is incorrect. To correct the situation, try:

- a. Press **Refresh** to get the gain values again and confirm they are correct or not.
- b. Change the I-8014W to another slot, repeat from step2 to step3 to confirm the gain values are correct or not.

Step4. Test the input function.

- a. Click **AI test** tag, and select the input range from the gain drop-down list.
- b. Input the total count of samples and choose the data format from the format drop-down list.
- c. Press **Start**.

	First Data	Min Data	Max Data	Delta		First Data	Min Data	Max Data	Delta
C0	02.6645	02.6636	02.6651	00.0015	C8				
C1	02.6642	02.6636	02.6651	00.0015	C9				
C2	02.6642	02.6639	02.6648	00.0009	C10				
C3	02.6642	02.6639	02.6651	00.0012	C11				
C4	02.6642	02.6636	02.6651	00.0015	C12				
C5	02.6642	02.6639	02.6648	00.0009	C13				
C6	02.6642	02.6636	02.6651	00.0015	C14				
C7	02.6642	02.6639	02.6651	00.0012	C15				

After the sampling process completed, the data is displayed in the columns following each channels.

- d. If necessary, press **Save** to save the data and sampling time into SampleData_Hex_mm_dd_hh_mim_sec.csv file.

Service-request requirement

When using a stable signal source such as a battery to output signal to the I-8014W and getting an incorrect or unstable data, prepare the following three items and e-mail to service@icpdas.com .

- The picture of physical wiring
- The file saved from the Basic Information tag (See [page 89, step 3](#))
- The file saved from the AI Test tag (See [page 91, step 4](#))

Why does the data read from I-8014W seem unstable?

If the battery testing could measure voltage correctly, but not the real signal source, it maybe caused by the following factors:

- a noise-corrupted signal source
- the instability of a signal source
- the floating signal source which does not reference to a system ground (earth or building ground)

Because the high speed data acquisition function of the I-8014W, it captures all the noise coupled on signal or any change of voltage on an unstable source. In this case, signal filtering or isolation should be considered to enhance the signal quality.

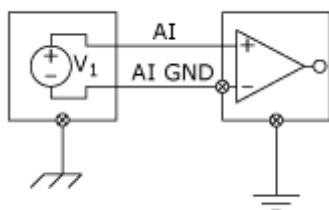

It is recommended to connect the V- to AGND (system ground) when measuring differential signals as the figure shows as below:

How to solve FIFO LATCHED error (-6)?

After Start Magic Scan instruction runs, it will go on scanning channel and converting data unless the stop command is executed, the data converted is saved into FIFO continuously. If we do not stop the Magic Scan after obtained data or we do not read data from FIFO in time, the FIFO will be filled and then locked. When the FIFO is locked, we will get FIFO LATCHED error (-6) and the new data cannot be saved into the FIFO.

To solve the error, we need execute the following instructions:

1. Stop the Magic Scan.
2. Read the rest of the data in FIFO or clear FIFO.
3. Unlock FIFO.
4. Start Magic Scan again.