

---

# CANopen Slave Device

## CAN-2054C

### Application User's Manual

#### **Warranty**

Without contrived damage, all products manufactured by ICP DAS are warranted in one year from the date of delivery to customers.

#### **Warning**

ICP DAS revises the manual at any time without notice. However, no responsibility is taken by ICP DAS unless infringement act imperils to patents of the third parties.

#### **Copyright**

Copyright © 2009 is reserved by ICP DAS.

#### **Trademark**

The brand name ICP DAS as a trademark is registered, and can be used by other authorized companies.

---

## Contents

<b>1</b>	<b>Introduction.....</b>	<b>3</b>
1.1	<b>Overview.....</b>	<b>3</b>
1.2	<b>Hardware Specifications .....</b>	<b>4</b>
1.3	<b>Features.....</b>	<b>5</b>
1.4	<b>Application .....</b>	<b>5</b>
<b>2</b>	<b>Hardware .....</b>	<b>6</b>
2.1	<b>Structure.....</b>	<b>6</b>
2.2	<b>Node ID &amp; Baud Rate Rotary Switch .....</b>	<b>7</b>
2.3	<b>I/O Pair-connection Mode.....</b>	<b>8</b>
2.4	<b>LED Description.....</b>	<b>10</b>
2.5	<b>PIN Assignment .....</b>	<b>12</b>
2.6	<b>Wire Connection .....</b>	<b>13</b>
<b>3</b>	<b>Object Dictionary .....</b>	<b>14</b>
3.1	<b>Object List.....</b>	<b>14</b>
3.2	<b>Store and Restore Object.....</b>	<b>17</b>
3.3	<b>Application Object.....</b>	<b>18</b>
3.4	<b>Default PDO Mapping .....</b>	<b>22</b>

---

# 1 Introduction

## 1.1 Overview

CANopen is one kind of the network protocols based on the CAN bus and mainly used for embedded network of machine control, such as industrial machine control , aircraft engines monitoring, factory automation, medical equipments control, remote data acquisition, environmental monitoring, and packaging machines control, etc.

CAN-2054C module follows the CiA DS-301 version 4.02 and DSP-401 version 2.1. It is easy to access the digital I/O status and set the configuration by using standard CANopen protocol. CAN-2054C has passed the validation of the CiA CANopen Conformance Test tool. Therefore, the provided EDS file is standard for any other standard CANopen masters. CAN-2054C has 8-channel isolated sink/source input and 8-channel isolated sink output and it can be used to various applications, such as PNP, NPN, TTL, relay contact and so forth. By owing to the CANopen masters of ICP DAS, you can quickly build a CANopen network to approach your requirements.



Figure 1-1

---

## 1.2 Hardware Specifications

### Digital Output:

- Output Channels: 8 (Sink)
- DO Load Voltage: +5 ~ +30 VDC
- Output Max Load Current: 700 mA per channel.
- Output Type: Open-Collector.
- Intra-module Isolation: 3750 Vrms
- Reaction Time:
  - DO Message to rising edge: 55 us.
  - DO Message to falling edge: 170 us.
- ESD Protection: 4 kV Contact for each channel

### Digital Input:

- Input Channels: 8 (Sink/Source).
- DI On Level: +3.5 ~ +30 VDC.
- DI Off Level: +1VDC Max.
- Input Impedance: 3 k $\Omega$ , 0.3 W.
- Intra-module Isolation: 3750 Vrms
- Response Time:
  - Rising edge to DI response: 75 us
  - Falling edge to DI response: 180 us
- ESD Protection: 4 kV Contact for each channel

### Others:

- CANopen Status: 3 LEDs for PWR / RUN / ERR.
- Terminal Resistor: 1 LED as terminator resistor indicators
- DI LED: 8 LEDs as digital input indicators.
- DO LED: 8 LEDs as digital output indicators.
- Power Supply: Unregulated +10 ~ +30 VDC.
- Power Consumption: 1.5 W.
- Operating Temperature: -25 ~ 75 °C.
- Storage Temperature: -35 ~ 80 °C.
- Humidity: 10 to 90% RH, Non-condensing.
- Dimensions: 32.5 mm x 110 mm x 102 mm (W x L x H) Detail.

---

## 1.3 Features

- Standard CANopen general I/O slave devices.
- CANopen Version: DS-301, v4.02.
- Device Profile: DSP-401, v2.1
- Support I/O pair-connection mechanism.
- Provide normal/polarity 8 DI channels and 8 DO channels
- CANopen transfer rate: 10 kbps, 20 kbps, 50 kbps, 125 kbps, 250 kbps, 500 kbps, 800 kbps, 1000 kbps.
- Support maximum CANopen slave devices Node-ID up to 99.
- Set Node-ID 0 for firmware update (after version 1.50-20111227).
  - Firmware updates tools: I-7530 series, I-7540D series, I-7565 series, PISO-CM100 series, and PISO-CAN series.
- Support NMT, PDO, SDO, EMCY, SYNC, Guarding, and Heartbeat protocol.
- Pass the validation of CANopen conformance test
- Provide EDS file for CANopen master interface

## 1.4 Application

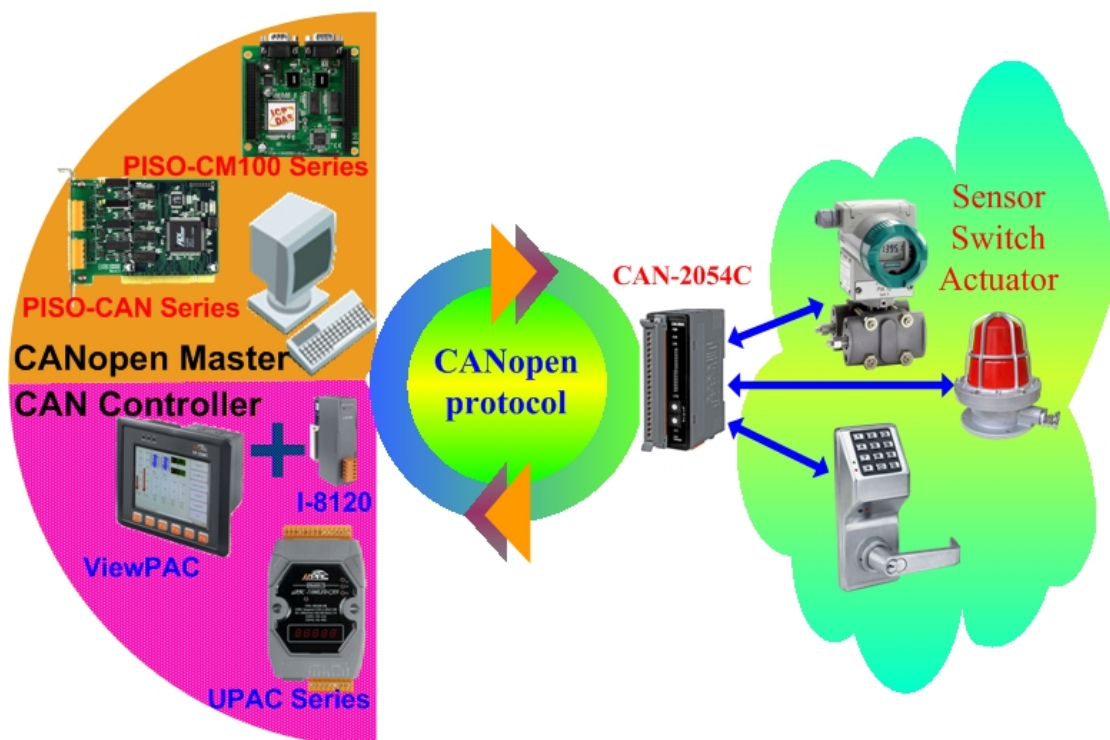

Figure 1-2 Application Structure

---

## 2 Hardware

### 2.1 Structure

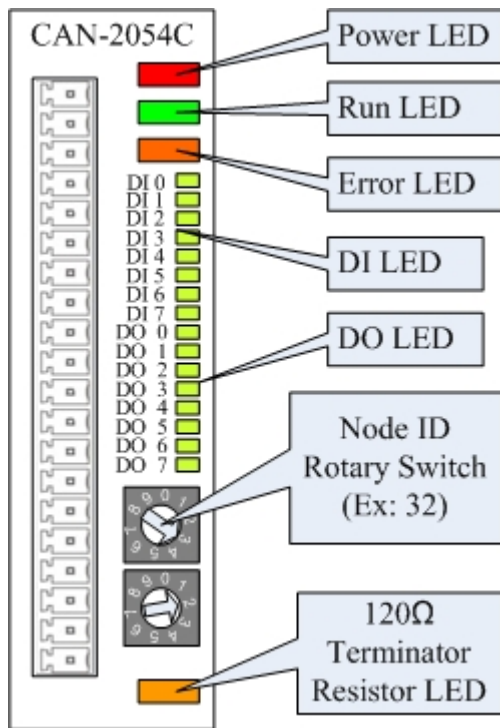

Figure 2-1 (Top View)

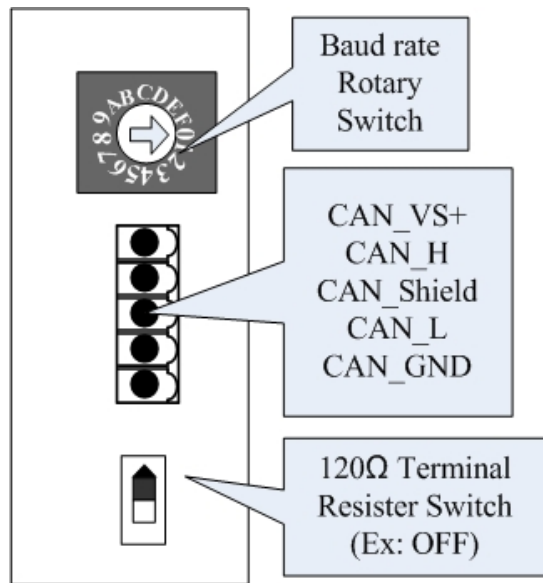
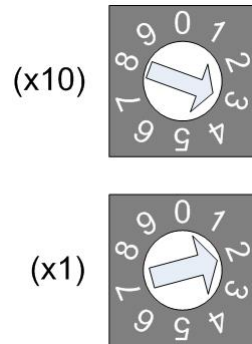

Figure 2-2 (Bottom View)

## 2.2 Node ID & Baud Rate Rotary Switch

The rotary switches of node ID configure the node ID of CAN-2054C module. These two switches are for the tens digit and the units digit of the node ID. The node ID value of this demo picture is 32.



**Figure 2-3 Node ID rotary switch**

The rotary switch of baud rate handles the CAN baud rate of CAN-2054C module. The value of baud rate switch from 0 ~ 7 are normal CANopen mode, and 8 ~ F are I/O pair-connection mode. About the I/O pair-connection mode please refer to section 2.3. The relationship between the rotary switch value and the practical baud rate is presented in the following table.



**Figure 2-4 Baud rate rotary switch**

Rotary Switch Value	Rotary Switch Value of I/O Pair-connection	Baud Rate (k bps)
0	8	10
1	9	20
2	A	50
3	B	125
4	C	250
5	D	500
6	E	800
7	F	1000

**Table 2-1**

---

## 2.3 I/O Pair-connection Mode

The CAN-2054C module provides the I/O pair-connection function. Before using this function, you need to prepare one CAN-2054C module and a 8-bit DO and 8-bit DI CAN-2000 series module (such as CAN-2054C). When applying this function, the DI channels of one CAN-2054C and the DO channels of another CAN-2054C are mapping with each other. That is to say that when the DI channels of one CAN-2054C get the ON signal, the corresponding DO channels of another CAN-2054C will be turned on.

When you completed the connection of these two CAN-2054Cs by CAN bus, you need to set the baud rate rotary switch of these two modules to 0x8 ~ 0xF, and configure the node ID of them by the special rule. Set the node ID to be odd for one module, and set the node ID of another module to be the value which is equal to the node ID increased one of the former. Therefore, they are the couple as the following figure.

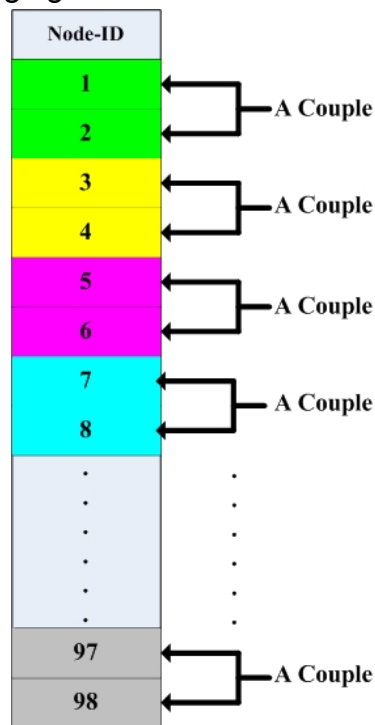
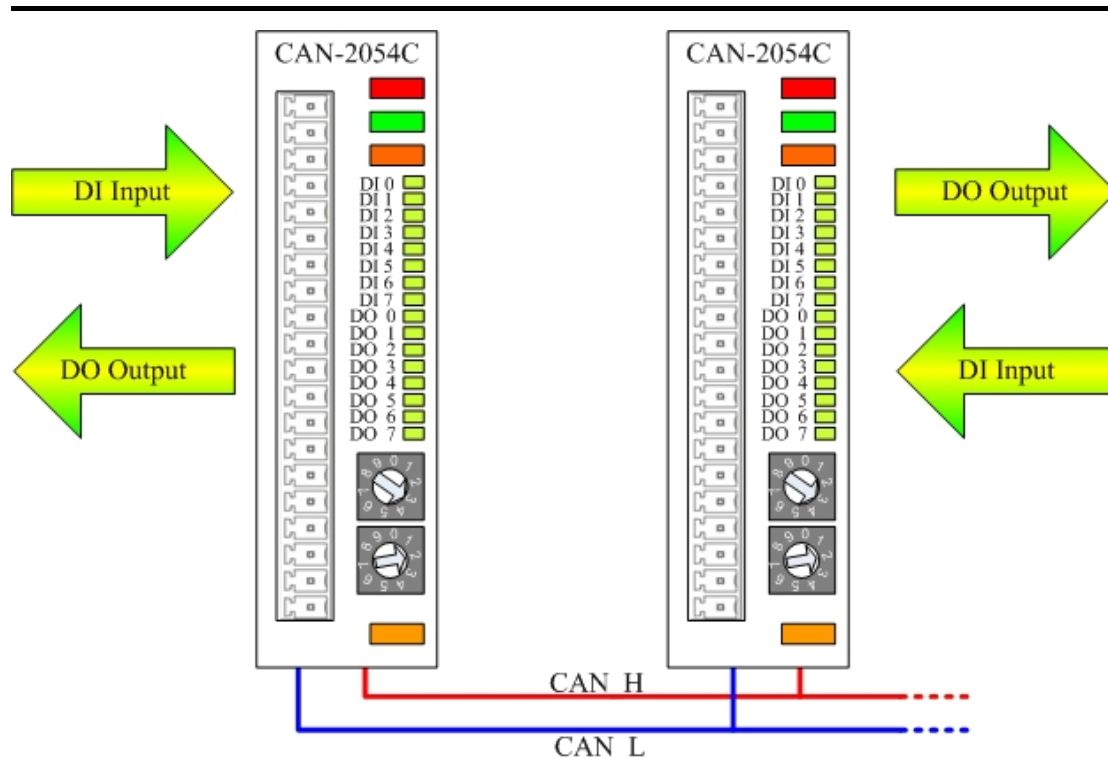

Figure 2-5

For example, user uses two CAN-2054Cs to do I/O pair-connection. The connection structure is as follows.





**Figure 2-6**

The node IDs of these two CAN-2054Cs are 1 and 2 respectively. Both of these two module's baud rate switch are selected to "D", 500 kbps CANopen baud rate with I/O pair-connection mode, and these two modules will into Operational state automatically. When the DI channel of one CAN-2054C receives a DI ON-signal, another CAN-2054C will output the ON-signal at the corresponding DO channel.

---

## 2.4 LED Description

### Power LED

CAN-2054C allows 10 VDC ~ 30 VDC for working voltage. The power consumption is 1.5 W. Under the connection of a proper power connection, as the unit is turned on, the LED will light up in red.

### Run LED

The Run LED indicates the CANopen operation state. The description of LED state is shown below. About the detail, please refer to the section 2.3.1 of the CAN-2000C user manual.

LED Signal	State	Description
No Light	Non-operation	Power Supply is not ready
Single Flash	Stopped	The device is in Stopped state
Blinking	Pre-operational	Device is in Pre-operational state
Continuing Light	Operational	Device is in Operational state

**Table 2-2**

### Error LED

The Error LED indicates the CANopen error state. The description of LED state is shown below. About the detail please refer to the section 2.3.2 of the CAN-2000C user manual.

LED Signal	State	Description
No Light	No error	Device is working well.
Single Flash	Error Warning	At least one CANopen error happened.
Double Flash	Guarding Fail	Guarding fail event happened.
Continuing Light	Bus Off	The bus off state happened.

**Table 2-3**

### Terminal Resistor LED

When enable the 120Ω terminator resistor, the LED will turn on.

### DO LED

If the DO LED turns on, it means that the corresponding DO channel is active no matter what the DO channel polarity is. (User can configure the 0x6202 object to change the polarity of the DO channel. Please refer to section 3.3 for detail.)

### DI LED

---

If the DI LED turns on, it means that the corresponding DI channel receives an ON voltage-level digital signal no matter what the DI channel polarity is. (User can configure the 0x6002 object to change the polarity of the DO channel. Please refer to section 3.3 for detail.)

---

## 2.5 PIN Assignment





















Terminal No.	Pin Assignment
 01	DI.COM
 02	DI0
 03	DI1
 04	DI2
 05	DI3
 06	DI4
 07	DI5
 08	DI6
 09	DI7
 10	DO0
 11	DO1
 12	DO2
 13	DO3
 14	DO4
 15	DO5
 16	DO6
 17	DO7
 18	DO.GND
 19	DO.GND
 20	DO.PWR

Figure 2-7

## 2.6 Wire Connection

Input Type	ON State LED ON Readback as 0	OFF State LED OFF Readback as 1
Relay Contact	Relay On	Relay Off
TTL/CMOS Logic	Voltage > 3.5 V	Voltage < 1 V
NPN Output	Open Collector On	Open Collector Off
PNP Output	Open Collector On	Open Collector Off
Output Type	ON State LED ON Readback as 1	OFF State LED OFF Readback as 0
Drive Relay	Relay On	Relay Off
Resistance Load		

Figure 2-8

## 3 Object Dictionary

### 3.1 Object List

#### General Communication Entries

Idx	Sidx	Description	Type	Attr	Default
1000h	0h	device type	UNSIGNED 32	RO	00300191h
1001h	0h	error register	UNSIGNED 8	RO	0h
1003h	0h	largest sub-index supported for “predefine error field”	UNSIGNED 8	RO	0h
	1h	actual error (the newest one)	UNSIGNED 32	RO	---
	...	...	...	...	---
	5h	actual error (the oldest one)	UNSIGNED 32	RO	---
1005h	0h	COB-ID of Sync message	UNSIGNED 32	RW	80h
1008h	0h	manufacturer device name	VISIBLE_STRING	RO	CAN-2054C
1009h	0h	manufacturer hardware version	VISIBLE_STRING	RO	1.2
100Ah	0h	manufacturer software version	VISIBLE_STRING	RO	1.50-20111227
100Ch	0h	guard time	UNSIGNED 16	RW	0h
100Dh	0h	life time factor	UNSIGNED 8	RW	0h
1010h	0h	largest sub-index supported for “store parameters”	UNSIGNED 8	RO	1h
1010h	1h	save all hardware parameter	UNSIGNED 32	RW	---
1011h	0h	largest sub-index supported for “restore default parameters”	UNSIGNED 8	RO	1h
1011h	1h	restore all default parameters	UNSIGNED 32	RW	---
1014h	0h	COB-ID of EMCY	UNSIGNED 32	RW	80h+x
1017h	0h	producer heartbeat time	UNSIGNED 16	RW	0
1018h	0h	largest sub-index supported for “identity object”	UNSIGNED 8	RO	4
	1h	vender ID	UNSIGNED 32	RO	---
	2h	product code	UNSIGNED 32	RO	---
	3h	revision number	UNSIGNED 32	RO	---
	4h	serial number	UNSIGNED 32	RO	---

**Table 3-1**

**Note: x is Node-ID of the module**

---

### **SDO Communication Entries**

Idx	Sidx	Description	Type	Attr	Default
1200h	0h	largest sub-index supported for “server SDO parameter”	UNSIGNED 8	RO	2
	1h	COB-ID form client to server (RxSDO)	UNSIGNED 32	RO	600h+x
	2h	COB-ID form server to client (TxSDO)	UNSIGNED 32	RO	580h+x

**Table 3-2**

**Note: x is Node-ID of the module**

### **RxPDO Communication Entry**

Idx	Sidx	Description	Type	Attr	Default
1400h	0h	Number of entries	UNSIGNED 8	RO	2
	1h	COB-ID used by RxPDO	UNSIGNED 32	RW	200h+x
	2h	Transmission type	UNSIGNED 8	RW	FFh

**Table 3-3**

**Note: x is Node-ID of the module**

### **RxPDO Mapping Communication Entry**

Idx	Sidx	Description	Type	Attr	Default
1600h	0h	Number of entries	UNSIGNED 8	RW	8
	1h	Write Output channel 0	UNSIGNED 32	RW	6200 0108h

**Table 3-4**

### **TxPDO Communication Entry**

Idx	Sidx	Description	Type	Attr	Default
1800h	0h	Number of entries	UNSIGNED 8	RO	5
	1h	COB-ID used by TxPDO	UNSIGNED 32	RW	180h+x
	2h	Transmission type	UNSIGNED 8	RW	FFh
	3h	Inhibit time	UNSIGNED 16		0
	4h	reversed	---	---	---
	5h	Event timer	UNSIGNED 16		0

**Table 3-5**

**Note: x is Node-ID of the module**

### TxPDO Mapping Communication Entry

Idx	Sidx	Description	Type	Attr	Default
1A00h	0h	Number of entries	UNSIGNED 8	RO	1
	1h	DI channel 0 ~ 7	UNSIGNED 32	RW	6000 0108h

**Table 3-6**

### Digital Input Function

Idx	Sidx	Description	Type	Attr	Default
6000h	0h	Number of Input 8-Bit	UNSIGNED 8	RO	1
	1h	DI value of ch0 ~ ch7	UNSIGNED 8	RO	0
6002h	0h	Number of Input 8-Bit	UNSIGNED 8	RO	1
	1h	Change polarity DI ch0 ~ ch7	UNSIGNED 8	RW	0
2030h	0h	Number of entries	UNSIGNED 8	RO	1
	1h	DI Scan Filter times	UNSIGNED 8	RW	2

**Table 3-7**

**Note: Object 0x2030h is used for DI noise. If there is any DI noise in your application, you can set the value larger to avoid the unexpected noise.**

### Digital Output Function

Idx	Sidx	Description	Type	Attr	Default
6200h	0h	Number of Output 8-Bit	UNSIGNED 8	RO	1
	1h	DO value of ch0 ~ ch7	UNSIGNED 8	RW	0
6202h	0h	Number of Output 8-Bit	UNSIGNED 8	RO	1
	1h	Change polarity DO ch0 ~ ch7	UNSIGNED 8	RW	0
6206h	0h	Number of Output 8-Bit	UNSIGNED 8	RO	2
	1h	Error mode DO ch0 ~ ch7	UNSIGNED 8	RW	0xFF
6207h	0h	Number of Output 8-Bit	UNSIGNED 8	RO	2
	1h	Error value DO ch0 ~ ch7	UNSIGNED 8	RW	0

**Table 3-8**

### Power On Value Function

Idx	Sidx	Description	Type	Attr	Default
2010h	0h	Number of Output 8-Bit	UNSIGNED 8	RO	1
	1h	Set DO power on value of ch0 ~ ch7	UNSIGNED 8	RW	0

**Table 3-9**



---

## 3.2 Store and Restore Object

User can write the value 0x65766173 to the object index 0x1010 to save configuration setting, or write the value 0x64616F6C to object index 0x1011 to load the factory default. The following table lists the relative objects which will be stored or restored after writing these two objects. The factory default for these objects is also shown.

### Store and Restore functions:

Index	Subindex	Function
1010 h	1	Store application and communication setting.
1010 h	2	Store communication setting only.
1010 h	3	Store application setting only.
1011 h	1	Restore application and communication setting.
1011 h	2	Restore communication setting only.
1011 h	3	Restore application setting only.

**Table 3-10**

### Communication Setting:

Please refer to above table 3-3, 3-4, 3-5, and 3-6.

### Application Setting:

Index	Sub Index	Description	Factory Default
2010 h	1	Set digital output power on value for channel 8 ~ 15	0x00
6002 h	1	Change polarity digital input for channel 0 ~ 7	0x00
6202 h	1	Change polarity digital output for channel 0 ~ 7	0x00
6206 h	1	Error mode digital output for channel 0 ~ 7	0xFF
6207 h	1	Error value digital output for channel 0 ~ 7	0x00

**Table 3-11**

### 3.3 Application Object

#### Digital Input module (0x6000)

User can use the object index 0x6000 with subindex 1 to read a group of 8-bit information.

For example, if the node id of CAN-2054C is 1, the commands are as below:

11-bit COB-ID (bit)											RTR	Data Length	8-byte Data (byte)							
Func Code				Node ID									0	1	2	3	4	5	6	7
10	9	8	7	6	5	4	3	2	1	0										
1	1	0	0	0	0	0	0	0	0	1	0	8	40	00	60	01	00	00	00	

**SDO client**



**SDO server  
(CAN-2054C)**

11-bit COB-ID (bit)											RTR	Data Length	8-byte Data (byte)							
Func Code				Node ID									0	1	2	3	4	5	6	7
10	9	8	7	6	5	4	3	2	1	0										
1	0	1	1	0	0	0	0	0	0	1	0	4	4F	00	60	01	0F	--	--	--

**SDO client**



**SDO server  
(CAN-2054C)**

Read the object index 0x6000 with subindex 1, and the digital value 0x0F will be responded by CAN-2054C module. The DI channels of DI3, DI2, DI1 and DI0 are turn on and others are turn off.

#### Change Input Polarity (0x6002)

User can configure the object index 0x6002 with subindex 1 to set the polarity of DI channels.

This object 0x6002 with subindex 1 defines the polarity of a group of 8 input lines. Input polarity can be inverted individually.

1 = input inverted.

0 = input not inverted.

For example, if the node id of CAN-2054C is 1, the commands are as below:

11-bit COB-ID (bit)											RTR	Data Length	8-byte Data (byte)							
Func Code				Node ID									0	1	2	3	4	5	6	7
10	9	8	7	6	5	4	3	2	1	0										
1	1	0	0	0	0	0	0	0	0	1	0	8	2F	02	60	01	F0	00	00	00

**SDO client**



**SDO server  
(CAN-2054C)**

11-bit COB-ID (bit)											RTR	Data Length	8-byte Data (byte)							
Func Code				Node ID									0	1	2	3	4	5	6	7
10	9	8	7	6	5	4	3	2	1	0										
1	0	1	1	0	0	0	0	0	0	1	0	4	60	02	60	01	--	--	--	--

**SDO client**



**SDO server  
(CAN-2054C)**

Write object index 0x6002 with subindex 1 to 0xF0 means that set the Ch0 ~ Ch3 of DI channels to normal, and set the Ch4 ~ Ch7 to be inverted.

### Digital Output module (0x6200)

User can set a group of 8 output lines as a byte of information and sent it into the object index 0x6200 with subindex 1 of CAN-2054C. For example, if the node id of CAN-2054C is 1, the commands are as below:

11-bit COB-ID (bit)											RTR	Data Length	8-byte Data (byte)							
Func Code				Node ID									0	1	2	3	4	5	6	7
10	9	8	7	6	5	4	3	2	1	0										
1	1	0	0	0	0	0	0	0	0	1	0	8	2F	00	62	01	0F	00	00	00

**SDO client**



**SDO server  
(CAN-2054C)**

11-bit COB-ID (bit)											RTR	Data Length	8-byte Data (byte)							
Func Code				Node ID									0	1	2	3	4	5	6	7
10	9	8	7	6	5	4	3	2	1	0										
1	0	1	1	0	0	0	0	0	0	1	0	4	60	00	62	01	--	--	--	--

**SDO client**



**SDO server  
(CAN-2054C)**

Write the 0x0F of digital output value into the object index 0x6200 with subindex 1, and its response success by CAN-2054C.

### Change Output Polarity (0x6202)

This object 0x6202 with subindex 1 defines the polarity of a group of 8 output lines. Output polarity can be inverted individually.

1 = output inverted.

0 = output not inverted.

For example, if the node id of CAN-2054C is 1, the commands are as below:

11-bit COB-ID (bit)											RTR	Data Length	8-byte Data (byte)							
Func Code				Node ID																
10	9	8	7	6	5	4	3	2	1	0			0	1	2	3	4	5	6	7
1	1	0	0	0	0	0	0	0	0	1	0	8	2F	02	62	01	F0	00	00	00

**SDO client**



**SDO server  
(CAN-2054C)**

11-bit COB-ID (bit)											RTR	Data Length	8-byte Data (byte)							
Func Code				Node ID																
10	9	8	7	6	5	4	3	2	1	0			0	1	2	3	4	5	6	7
1	0	1	1	0	0	0	0	0	0	1	0	4	60	02	62	01	--	--	--	--

**SDO client**



**SDO server  
(CAN-2054C)**

Write object index 0x6202 with subindex 1 to 0xF0 means that set the Ch0 ~ Ch3 of DO channels to normal, and set the Ch4 ~ Ch7 to be inverted.

### **Error Mode and Error Value (0x6206, 0x6207)**

The object 0x6206 and 0x6207 are used to control the safe value when error happens. When some error event of this module happens such as node guarding failure, the module will check the value of the object 0x6206. If some bits of this value are set to 1, the corresponding DO channels will be into the error mode output. The error mode output values are concerned to the object 0x6207. For example, if the subindex 01 in the object with 0x6206 and 0x6207 are 0x31 and 0xF8 respectively, when some error event occurs, only the DO5, DO4, DO0 will be changed to error mode output because the bit 5, bit 4, and bit 0 of the value 0x31 is 1. The others channels keeps the status as the error event is not happened. The bit 5, bit 4, and bit 0 of the value 0xF8 are 1, 1 and 0, therefore the error mode output value of DO5, DO4 and DO0 are active, active, and inactive respectively.

11-bit COB-ID (bit)											RTR	Data Length	8-byte Data (byte)							
Func Code				Node ID																
10	9	8	7	6	5	4	3	2	1	0			0	1	2	3	4	5	6	7
1	1	0	0	0	0	0	0	0	0	1	0	8	2F	06	62	01	31	00	00	00

**SDO client**



**SDO server  
(CAN-2054C)**

11-bit COB-ID (bit)											RTR	Data Length	8-byte Data (byte)							
Func Code				Node ID									0	1	2	3	4	5	6	7
10	9	8	7	6	5	4	3	2	1	0										
1	0	1	1	0	0	0	0	0	0	1	0	8	60	06	62	01	--	--	--	--

**SDO client**



**SDO server  
(CAN-2054C)**

Write object index 0x6206 and subindex 1 to 0x31 means set the error mode to 0x31 for enabling the error mode output of DO 0, DO 4 and DO5.

11-bit COB-ID (bit)											RTR	Data Length	8-byte Data (byte)							
Func Code				Node ID									0	1	2	3	4	5	6	7
10	9	8	7	6	5	4	3	2	1	0										
1	1	0	0	0	0	0	0	0	0	1	0	8	2F	07	62	01	F8	00	00	00

**SDO client**



**SDO server  
(CAN-2054C)**

11-bit COB-ID (bit)											RTR	Data Length	8-byte Data (byte)							
Func Code				Node ID									0	1	2	3	4	5	6	7
10	9	8	7	6	5	4	3	2	1	0										
1	0	1	1	0	0	0	0	0	0	1	0	8	60	07	62	01	--	--	--	--

**SDO client**



**SDO server  
(CAN-2054C)**

Write object index 0x6207 and subindex 1 to 0xF8 means set the error value to 0xF8 for activating the error mode output value of DO 3 ~ DO 7. If the error event in this module, the module will output the safe value 0x30 (0x31 & 0xF8 = 0x30) corresponding the object 0x6206 and 0x6207.

### **Set Power On Value (0x2010)**

This object 0x2010 with subindex 1 defines the power on value of a group of 8 output lines. Power on value can be set individually.

For example, if the node id of CAN-2054C is 1, the commands are as below:

11-bit COB-ID (bit)											RTR	Data Length	8-byte Data (byte)							
Func Code				Node ID									0	1	2	3	4	5	6	7
10	9	8	7	6	5	4	3	2	1	0										
1	1	0	0	0	0	0	0	0	0	1	0	8	2F	10	20	01	F0	00	00	

**SDO client**  **SDO server (CAN-2054C)**

11-bit COB-ID (bit)											RTR	Data Length	8-byte Data (byte)							
Func Code				Node ID									0	1	2	3	4	5	6	7
10	9	8	7	6	5	4	3	2	1	0										
1	0	1	1	0	0	0	0	0	0	1	0	4	60	10	20	01	--	--	--	

**SDO client**  **SDO server (CAN-2054C)**

Write object index 0x2010 with subindex 1 to 0xF0 means that set the Ch0 ~ Ch3 of DO channels to 0, and set the Ch4 ~ Ch7 to 1 when the CAN-2054C power on.

### 3.4 Default PDO Mapping

RxPDO mapping list:

ID	Len	D 0
200h + x	1	DO 0 ~ DO 7

**Table 3-12 Default RxPDO list**

**Note: x is Node-ID of the module**

TxPDO mapping list:

ID	Len	D 0
180h + x	1	DI 0 ~ DI 7

**Table 3-13 Default TxPDO list**

**Note: x is Node-ID of the module**