



JetNet 4508 V2 /4508f V2 Series JetNet 4508i/JetNet 4508if Series

Industrial 8-port Managed Fast Ethernet Switch

User's Manual

Version 1.14

Firmware V1.2



www.korenix.com



JetNet 4508 V2 / 4508f V2 Series
JetNet 4508i/ JetNet 4508if Series
Industrial 8-port Managed Fast Ethernet Switch
User's Manual

Copyright Notice

Copyright © 2011 Korenix Technology Co., Ltd.

All rights reserved.

Reproduction in any form or by any means without permission is prohibited.



Declaration of CE

This product has passed the CE certification for environmental specifications. Test conditions for passing included the equipment being operated within an industrial enclosure. In order to protect the product from being damaged by ESD (Electrostatic Discharge) and EMI leakage, we strongly recommend the use of CE-compliant industrial enclosure products.

Federal Communications Commission (FCC) Statement

This equipment has been tested and found to comply with the limits for a Class A digital device, pursuant to Part 15 of the FCC Rules. These limits are designed to provide reasonable protection against harmful interference when the equipment is operated in a commercial environment. This equipment generates, uses, and can radiate radio frequency energy and, if not installed and used in accordance with the instruction manual, may cause harmful interference to radio communications. Operation of this equipment in a residential area is likely to cause harmful interference in which case the user will be required to correct the interference at his expense.

The user is cautioned that changes and modifications made to the equipment without approval of the manufacturer could void the user's authority to operate this equipment.



Interocean Technology Corp. Filing No.: 11A063002E-C

Verification of Conformity

Applicant : **Korenix Technology Co., Ltd.**
FI 2, No.188, Bao-ciao Rd., Shing Tien City, Taipei 23145, Taiwan

Product : **Switching Hub**
Model No. : JetNet 4508 V2; JetNet 4508f V2

On the basis of the tests undertaken, the sample(s) of the above product have been found to comply with the essential requirements of the referenced specifications at the time the tests were carried out.

Relevant Standard(s) / Specification(s)

EN 50121-1: 2006
EN 50121-4: 2006

Issued By:

Date: Jul. 13, 2011

JT Chen / General Manager





Interocean Technology Corp. Filing No.: 13A120302E-C17

Verification of Conformity

Applicant : **Korenix Technology Co., Ltd.**
2F., No.188, Baociao Rd., Sindian Dist., New Taipei City 23145,
Taiwan (R.O.C.)

Product : **Switching Hub**

Model No. : JetNet 4508i; JetNet 4508i-w; JetNet 4508if-m;
JetNet 4508if-s; JetNet 4508if-mw; JetNet 4508if-sw

**On the basis of the tests undertaken, the sample(s) of the above product
have been found to comply with the essential requirements of the
referenced specifications at the time the tests were carried out.**

Relevant Standard(s) / Specification(s)

IEC 61850-3: 2002 for EMC, climatic and mechanical conditions Test
IEC/TS 61000-6-5: 2001 for EMC immunity in substation environments

Issued By:



Mike Huang / President

Date: Jan. 15, 2014



**IEEE 1613 verification of conformity for JetNet 4508i /
JetNet 4508if series**



Interocean Technology Corp. Filing No.: 13A120302E-C27

Verification of Conformity

Applicant : Korenix Technology Co., Ltd.
2F., No.188, Baociao Rd., Sindian Dist., New Taipei City 23145,
Taiwan (R.O.C.)

Product : Switching Hub

**Model No. : JetNet 4508i; JetNet 4508i-w; JetNet 4508if-m;
JetNet 4508if-s; JetNet 4508if-mw; JetNet 4508if-sw**

**On the basis of the tests undertaken, the sample(s) of the above product
have been found to comply with the essential requirements of the
referenced specifications at the time the tests were carried out.**

Relevant Standard(s) / Specification(s)

IEEE 1613: 2009 (Control Power Inputs, Insulation & EMC Test)

Issued By:



Mike Huang / President

Date: Jan. 15, 2014



Index

1	Introduction	2
1.1	Overview	2
1.2	Major Features	3
1.3	Package List.....	4
2	Hardware Installation	5
2.1	Hardware Introduction	6
2.2	Wiring the Power Inputs	11
2.3	Wiring Digital Input	13
2.4	Wiring Relay Output	13
2.5	Wiring Earth Ground.....	14
2.6	Wiring Fast Ethernet RJ-45 Ports.....	15
2.7	Wiring Fast Ethernet Fiber port (JetNet 4508f V2)	16
2.8	Wiring RS-232 Console Cable.....	16
2.9	DIN-Rail Mounting Installation	17
3	Preparation for Management.....	18
3.1	Preparation for Serial Console	19
3.2	Preparation for Web Interface	20
3.3	Preparation for Telnet Console	23
4	Feature Configuration	26
4.1	Command Line Interface Introduction.....	27
4.2	Basic Setting	32
4.3	Port Configuration	53
4.4	Network Redundancy	63
4.5	VLAN.....	83
4.6	Private VLAN.....	91
4.7	Traffic Prioritization.....	98
4.8	Multicast Filtering	103
4.9	SNMP	108
4.10	Security	112
4.11	Warning	119
4.12	Monitor and Diag.....	128
4.13	Device Front Panel.....	137
4.14	Save to Flash	138
4.15	Logout	139
5	Appendix.....	140
5.1	Product Specifications – JetNet 4508 /JetNet 4508f	140



5.2	Product Specifications – JetNet 4508i /JetNet 4508if	145
5.3	Korenix Private MIB.....	150
5.4	Modbus TCP protocol.....	151
5.5	Revision History	163
5.6	About Korenix.....	164

1 Introduction

Welcome to Industrial 8-port Managed Fast Ethernet Switch User Manual. Following topics are covered in this chapter:

1.1 Overview

1.2 Major Features

1.3 Package Checklist

1.1 Overview

The JetNet 4508 V2/ 4508f V2 /JetNet 4508i/JetNet 4508if series are 8-port industrial managed Fast Ethernet Switch designed with advanced Layer 2 management features and high system reliability, including MSR and MSTP network redundancy technologies, for ensuring real-time and high quality connectivity in various networking applications. The Ethernet switches includes 6 10/100Mbps plus 2 100Mbps Fast Ethernet ports in RJ-45 connectors (JetNet 4508 V2, JetNet 4508i) or 6 10/100Mbps Fast Ethernet ports plus 2 100Mbps Fast Ethernet Fiber ports (JetNet 4508f v2, JetNet 4508if); Both of switches adopted 32Gbps switch fabric to provide real time non-blocking transmission performance for satisfying the needs of high bandwidth data transmission requiring applications while ensuring traffic switching without data loss. Besides, the new system design includes a hardware based watchdog timer for keeping the operating system live. It also provides power redundancy with wide range DC10V~60V inputs for ensuring the power continuity in the system. Combining the outstanding L2 management features along with the LLDP and the JetView Pro Intelligent NMS into the ruggedized design with IP31 enclosure and -25~70°C (regular version) and -40~75°C (-w version) wide operating temperature, JetNet 4508 and 4508i series provide highly reliable and secure data transmission under severe industrial environments.

The JetNet 4508i series are similar as JetNet 4508v2 series, but with different excellent electrical power system design and EMC protection. Except the Electrical Power System, the reset of Ethernet Switch function is same as JetNet 4508 series.

To make easy understand, this manual will use common product name except some of different functions will be descript separated

JetNet 4508: JetNet 4508v2 or JetNet 4508i

JetNet 4508f: JetNet 4508f v2 or JetNet 4508if

1.2 Major Features

The JetNet Managed Switch has the following features for both of JetNet 4508/4508f series (Heavy Ind./ Track Side model) and JetNet 4508i /if series (Substation model)

- 6 10/100TX ports with Auto MDI/MDI-X
- 2 100Base-TX (JetNet 4508), 2 100Base-FX (JetNet 4508f)
- 32Gbps Non-Blocking, 8K MAC address table
- Multiple Super Ring (recovery time <5ms), Rapid Dual Homing, Multiple Ring, and MSTP / RSTP
- IEEE 1588 Precision Time Protocol for precise time synchronization
- VLAN, Private VLAN, QinQ, GVRP, QoS, IGMP Snooping V1/V2/V3, Rate Control, Port Trunking, LACP, Online Multi-Port Mirroring
- IEEE 802.1AB LLDP and JetView Pro i²NMS for auto-topology and group management
- Supports SNMP, Multiple Language Web UI, Telnet In-Band, Serial Out-Band Management
- Supports ModBus TCP/Client function for HMI system.
- Embedded Hardware Watchdog for System Auto Rescue
- Dual DC10~60V Power Inputs with Redundancy
- Software configurable Alarm Output
- IP31 rugged aluminum case
- Operating temperature:
 - 25~70°C (JetNet 4508), -10~70°C (JetNet 4508f) and -40~75°C (JetNet 4508-w/ JetNet 4508f-w)

* If there is any specification change, please refer to the Web site or contact your sales window.

The detail spec is listed in Appendix

Note-1: those certifications are pending for special project request, please contact your sales window.

1.3 Package List

Korenix JetNet 4508 Series products are shipped with following items:

- JetNet Switch x1
- One DIN-Rail clip (attached to the switch)
- One RS-232 DB-9 to RJ-45 console cable
- CD User manual x 1
- Quick Installation Guide (QIG)



JetNet 4508 / JetNet 4508f



DB-9 to RJ-45
Cable



CD User
Manual



QIG

If any of the above items is missing or damaged, please contact your local sales representative.

2 Hardware Installation

This chapter includes hardware introduction, installation and configuration information. Following topics are covered in this chapter:

2.1 Hardware Introduction

- Dimension

- Panel Layout

- Bottom View

2.2 Wiring Power Inputs

2.3 Wiring Digital Input

2.4 Wiring Relay Output

2.5 Wiring Ethernet Ports

2.6 Wiring RS-232 console cable

2.7 DIN-Rail Mounting Installation

2.1 Hardware Introduction

Dimension of JetNet 4508 series

8-port managed Fast Ethernet Switch dimension is:

55 (W) x 149 (H) x 131.2 (D) / with DIN Rail Clip

55 (W) x 149 (H) x 120.6 (D) / without DIN Rail Clip

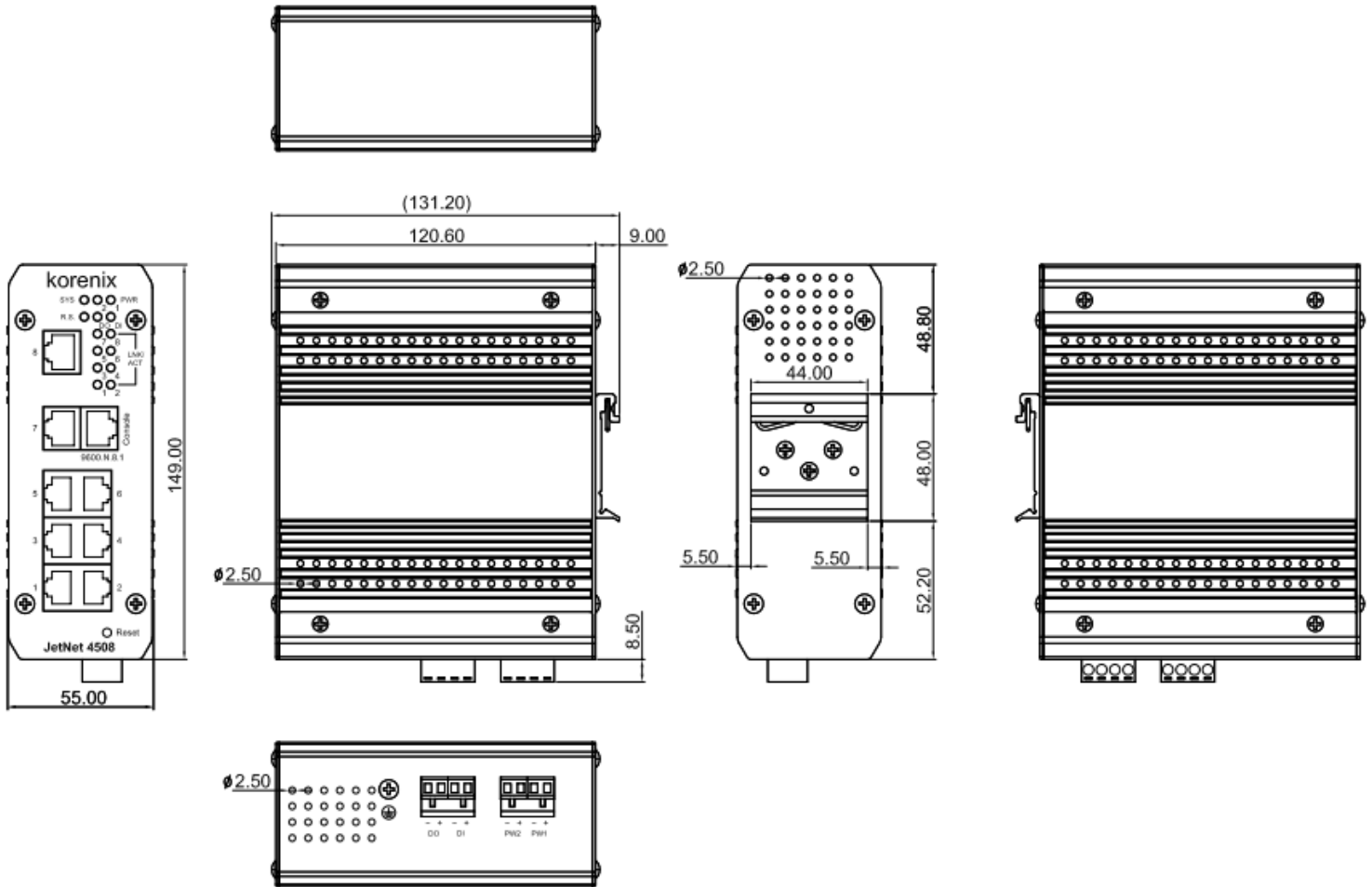

Dimension of JetNet 4508f series

Industrial 6-port plus 2 100Mbps Fiber managed Fast Ethernet Switch

dimension is:

55 (W) x 149 (H) x 131.2 (D) / with DIN Rail Clip

55 (W) x 149 (H) x 120.6 (D) / without DIN Rail Clip

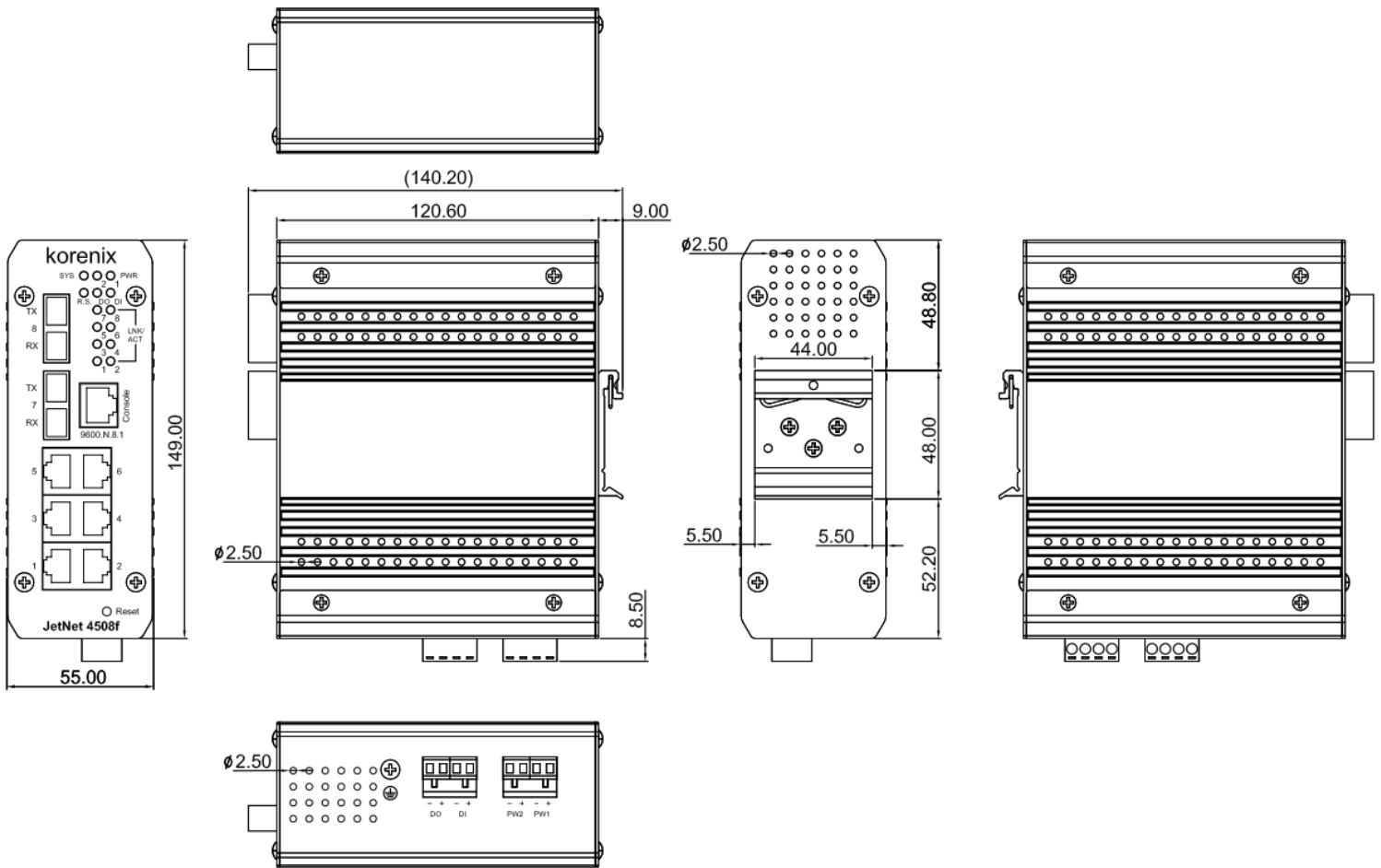

Front Panel Layout- JetNet 4508 series

The front panel of JetNet 4508 includes 8 10/100Mbps Fast Ethernet RJ-45 ports, one RS-232 serial console in RJ-45 type connector, one reset button and several of LED indicators for the system and port diagnostic. The JetNet 4508 front panel shows as following diagram.

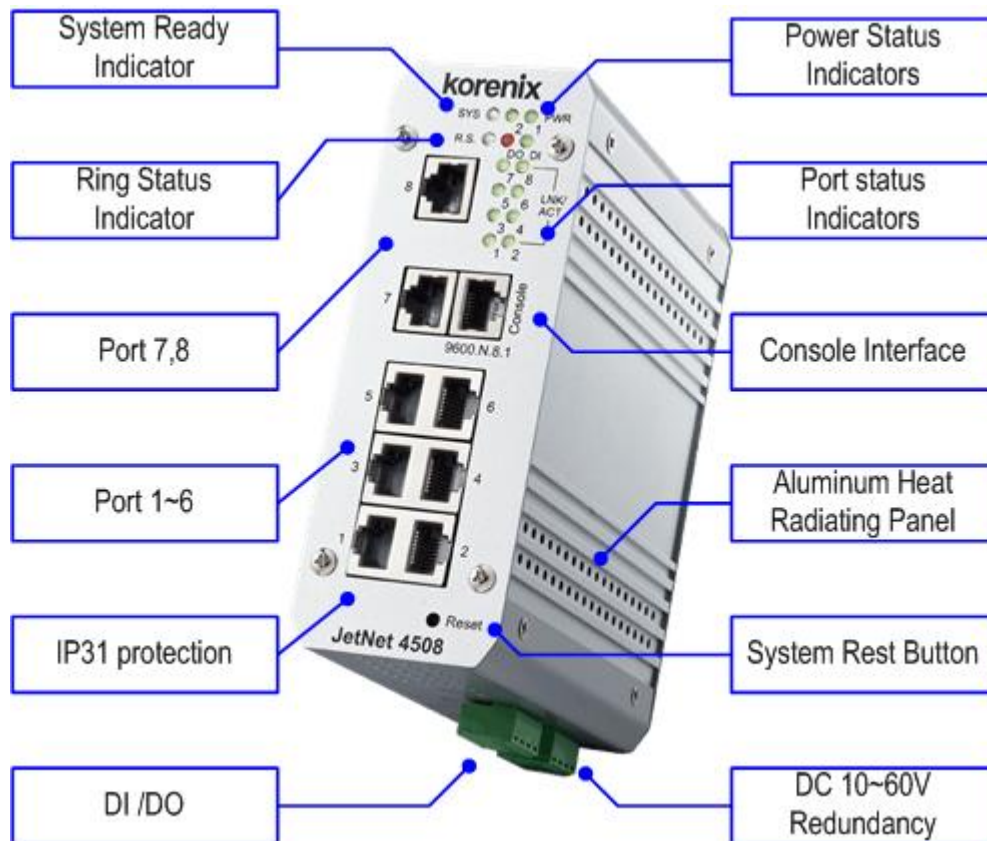

Front Panel Layout- JetNet 4508f series

The front panel of JetNet 4508f includes 6 10/100Mbps Fast Ethernet RJ-45 ports (port 1~6), 2 Fast Ethernet fiber ports (port 7, 8), one RS-232 serial console in RJ-45 type connector, one reset button and several of LED indicators for the system and port diagnostic. The JetNet 4508f V2 front panel shows as following diagram.

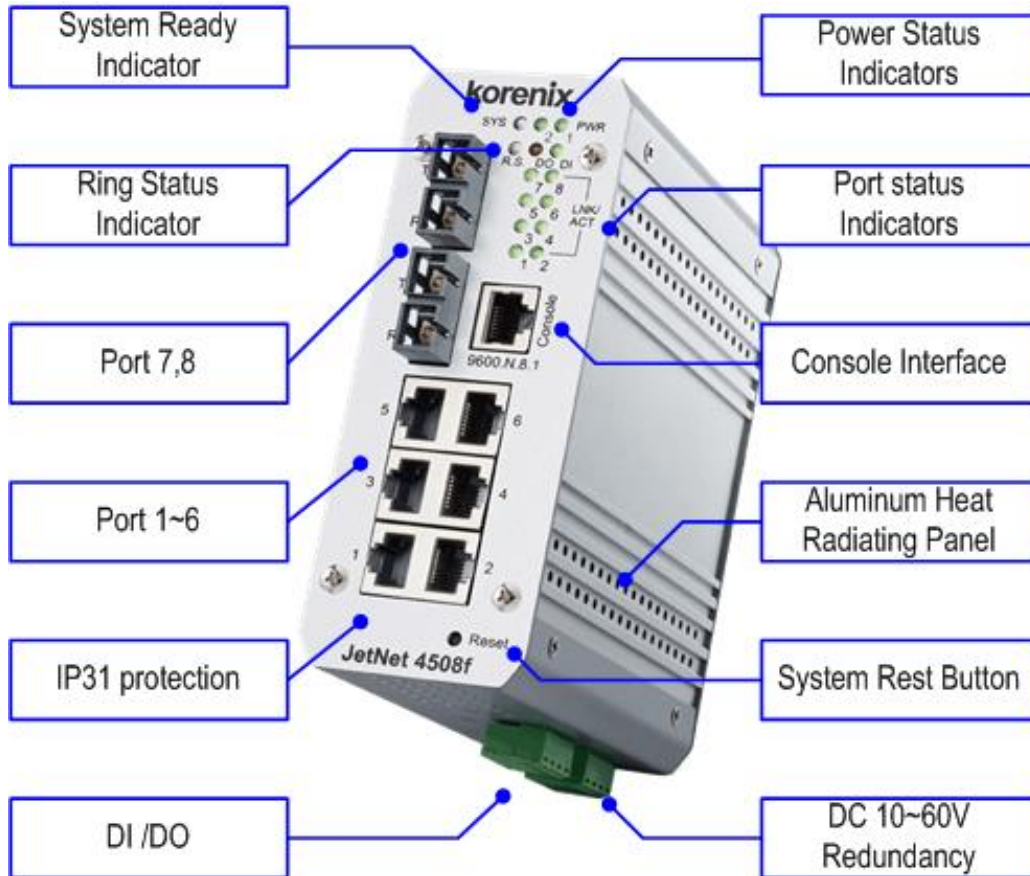

The LED function is described as following table:

LED	Function	Behaviors
Power 1,2	Indicates the power input status	On: the input connector is on applying power.
SYS	Indicates the system operating status	On: System is ready to operating
DI	Indicates the digital input status	On: High level signal is applied
DO	Indicates the digital output (Relay output) status	Red On: the output is formed close circuit
R.S.	Indicates the ring operating status.	Normal (Green on), Abnormal (Yellow on), wrong ring port is connected (Green blinking), one of device's ring path is broken (Yellow blinking)
Link/active	Indicated the traffic status and link	On: port is linked with partner.

	status	Blinking: the port is on transmitting or receiving data.
--	--------	--

Bottom View

The bottom view of the JetNet 4508 V2 / JetNet 4508f V2 consists of two terminal block connectors with two DC power inputs, one Digital Input (DI), one Relay Output (DO) and one Chassis Grounding screw.

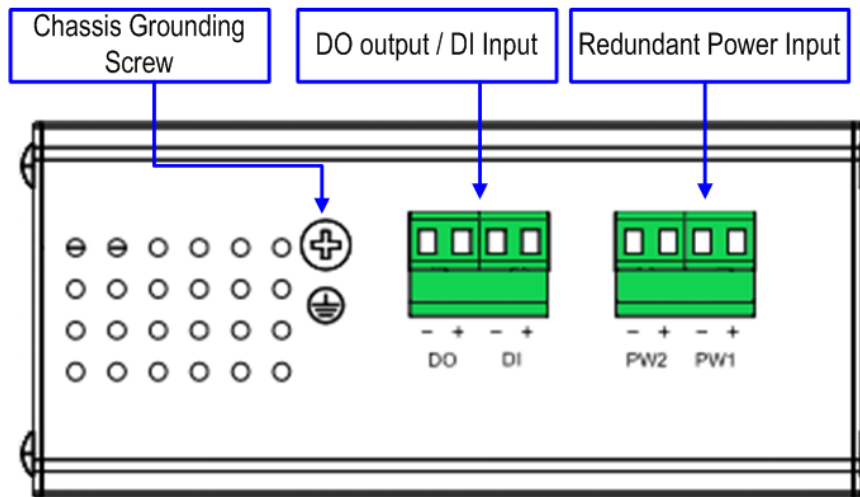

2.2 Wiring the Power Inputs

Follow below steps to wire JetNet 4508V2 /4508f V2 redundant DC power inputs.

1. Insert positive and negative wires into V+ and V- contacts respectively of the terminal block connector
2. Tighten the wire-clamp screws to prevent DC wires from being loosened.
3. Power 1 and Power 2 support power redundancy and polarity reverse protect function. That means with wrong polarity, the system won't work.
4. Positive and negative power system inputs are both accepted, but Power 1 and Power 2 must apply with same mode as following figures.

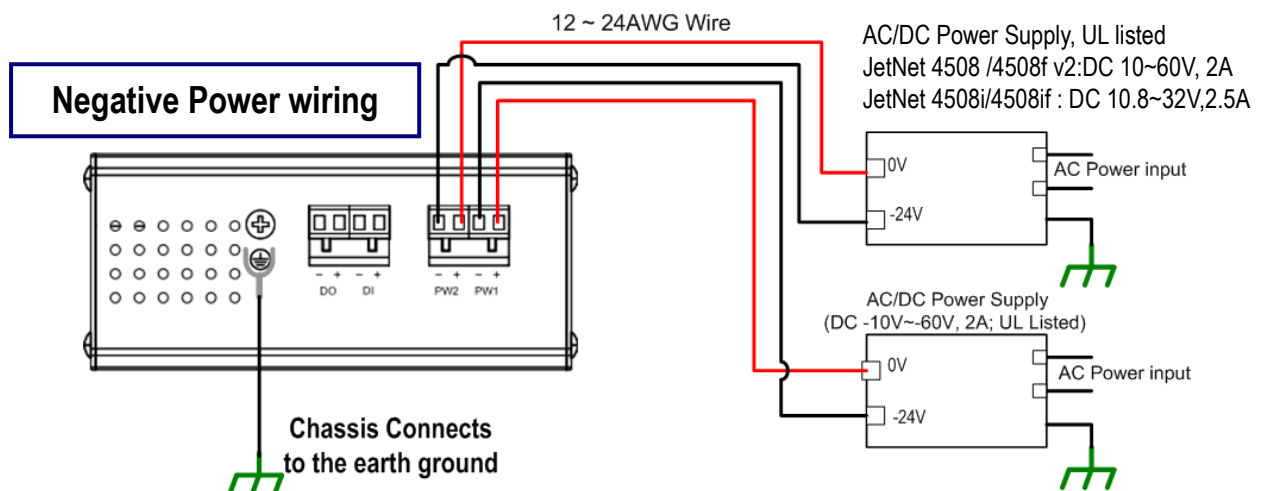
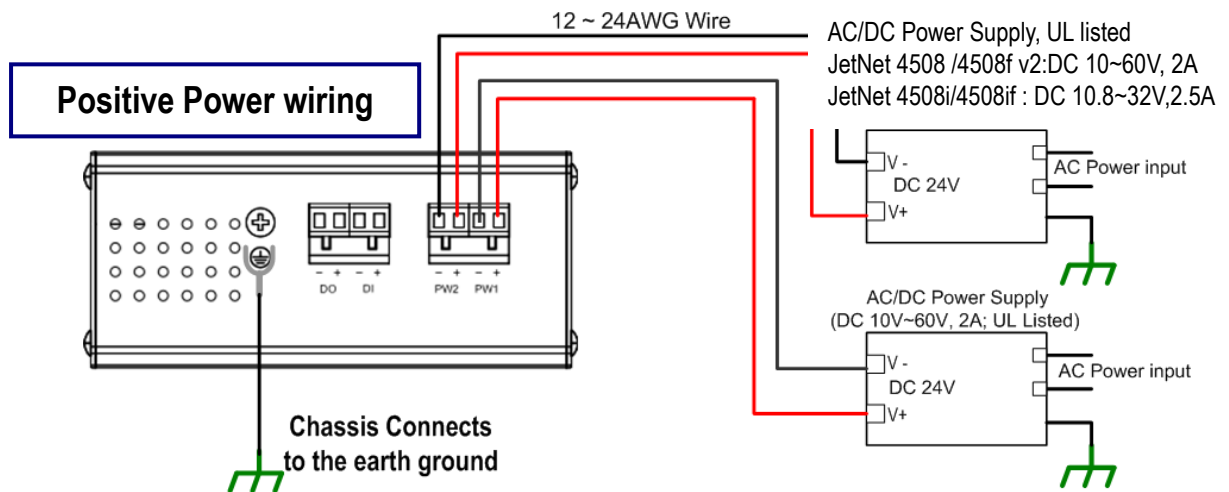

Note 1: It is a good practice to turn off input and load power, and to unplug power terminal block before making wire connections. Otherwise, your screwdriver blade can inadvertently short your terminal connections to the grounded enclosure.

Note 2: The range of the suitable electric wire is from 12 to 24 AWG.

Note 3: If the 2 power inputs are connected, JetNet Switch will be powered from the highest connected voltage. The unit will alarm for loss of power, either PWR1 or PWR2 and auto backup with each other.

Note 4: JetNet 4508 v2/ JetNet 4508f v2 series, uses the UL Listed Power supply with output Rating 10-60 Vdc, minimum 2 A. Here, we recommended use DC 24V as the operating voltage.

JetNet 4508i/ JetNet 4508if series, uses the UL Listed Power supply with output Rating 10.8-32 Vdc, minimum 2.5 A. Here, we recommended use DC 24V as the operating voltage.

Note 5: Once the system powering on, the system diagnostic LEDs will activate as the sequence shown in the following table:

Indicators	Stage 1	Stage 2	Stage 3	Stage 4	Stage 5	Stage 6
Power LED	On	On	On	On	On	On
DI	Off	On	Off	Off	Off	Off
DO	Off	Off	On	Off	Off	Off
R.S.	Off	Off	Off	On	Off	Off
SYS	Off	Off	Off	Off	Off	On
Description	Power on	Ex. Booter	Ld. firmware	Ex. firmware	System booting	System Ready

By those LED indicators, we can know the exactly stage is performed during the system power on.

2.3 Wiring Digital Input

JetNet 4508/JetNet 4508f series provide one digital input. It allows users to connect the termination units' digital output and manage/monitor the status of the connected unit. The Digital Input pin can be pulled high or low; thus the connected equipments can actively drive these pins high or low. The embedded software UI allows you to read and set the value to the connected device.

The power input voltage of logic low is DC 0~10V. Logic high is DC 11~30V.

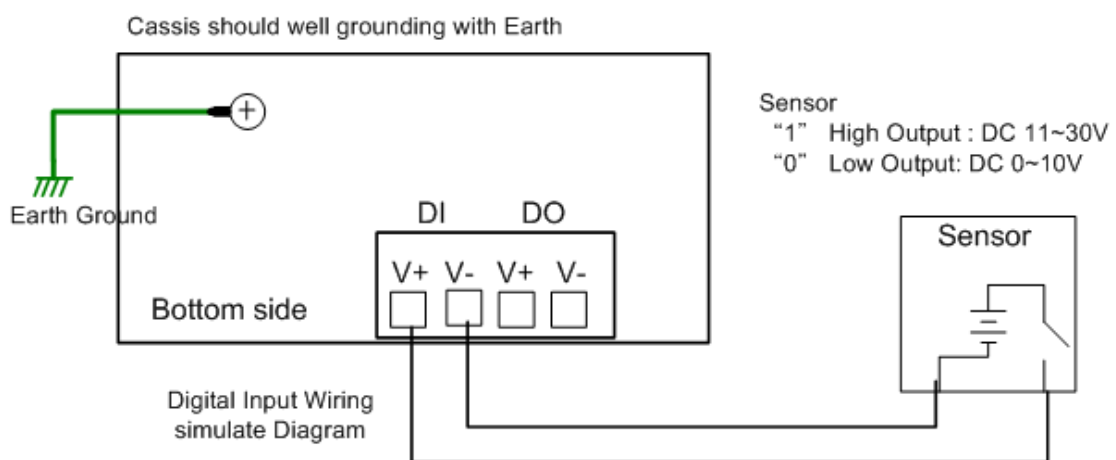

2.4 Wiring Relay Output

JetNet 4508/4508f series provide one Digital output, also known as Dry Relay Output. The relay contacts are energized (open) for normal operation and will close for fault conditions. The fault conditions include power failure, Ethernet port link break or other pre-defined events which can be configured in JetNet 4508 Web user interface.

Chassis should well grounding with Earth

DO (Relay) carry current: 1A/DC 24V

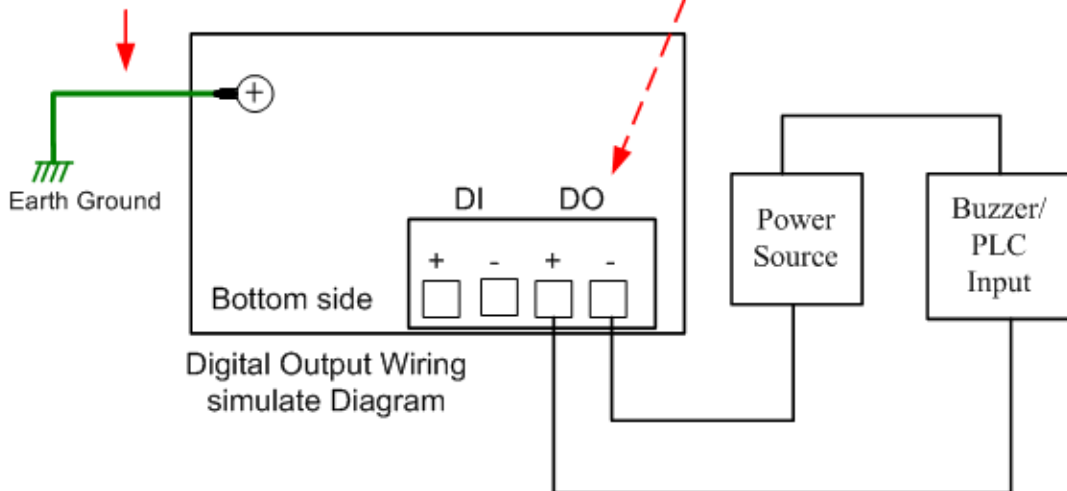

2.5 Wiring Earth Ground

To ensure the system will not be damaged by noise or any electrical shock, we suggest you to make exact connection with JetNet 4508 / 4508f series with Earth Grounding.

On the bottom side of JetNet 4508/ 4508f series, there is one earth ground screw. Loosen the earth ground screw by screw driver; then tighten the screw after earth ground wire is well connected.

Without the exact system chassis grounding, the communication may be interfered by the external noise, such as lightning, fast electrical field transient or electrostatic discharge.

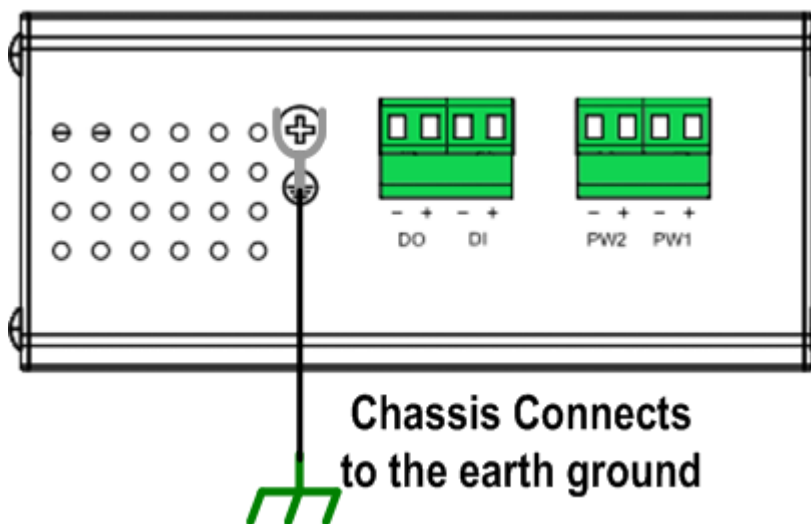

2.6 Wiring Fast Ethernet RJ-45 Ports

The JetNet 4508 / 4508f series adopts several of RJ-45 connectors which support 10/100Base-TX with link speed auto negotiation and auto MDI/MDI-X functions.

All the RJ-45 ports will auto-detect the signal from connected devices to negotiate the link speed and duplex mode. Auto MDI/MDIX allows users to connect another switch, hub or workstation without changing straight through or crossover cable.

Note: that crossover cables simply cross-connect the transmit lines at each end to the received lines at the opposite end.

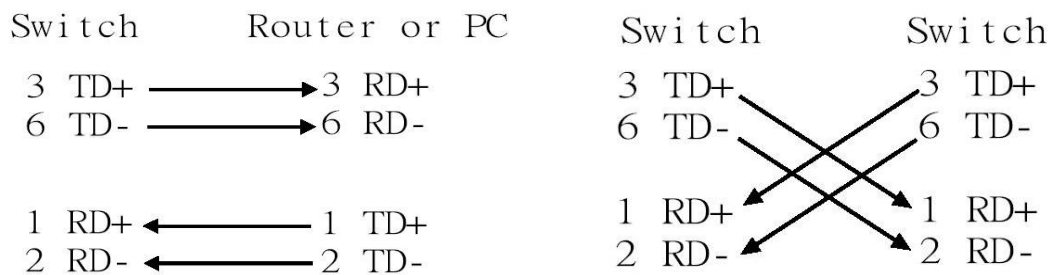

Pin MDI-X	Signals	MDI Signals
1	RD+	TD+
2	RD-	TD-
3	TD+	RD+
6	TD-	RD-

Connect one side of an Ethernet cable into any switch port and connect the other side to your attached device. The LNK LED will light up when the cable is correctly connected. Refer to the LED Indicators section for descriptions of each LED indicator. Always make sure that the cables between the switches and attached devices (e.g. switch, hub, or workstation) are less than 100 meters (328 feet).

The supported cable types listed as below:

100Base-TX: 4-pair UTP/STP Cat. 5 Cable, EIA/TIA-568B 100-ohm (100 meters)

10Base-T: 4-pair UTP/STP Cat.3, 4 cable, EIA/TIA-568B 100-ohm (100meters)

2.7 Wiring Fast Ethernet Fiber port (JetNet 4508f V2)

JetNet 4508f V2 equipped 2 ports fiber which compliance with IEEE 802.3 100Base-FX standard and supports multi-mode or single mode fiber cable. The fiber connector supports SC type connector and for the other type connector, please contacts your Korenix distributor for more information. To ensure the quality of connection, the specifications of cable and fiber port must matched; with wrong fiber cable may caused the communication does not work well. The following information is the specification includes suitable cable and the characteristics of fiber port.

Model	TX power	RX sensitivity	Wavelength	Fiber Cable
JetNet 4508f-s V2, 30KM	-8~-15 dBm	-31~-14dBm	1310nm	8~10/125 um Single mode
JetNet 4508f-m V2 2KM	-14~-31 dBm	-14~-31 dBm	1310nm	50~62.5/125um Multi-mode

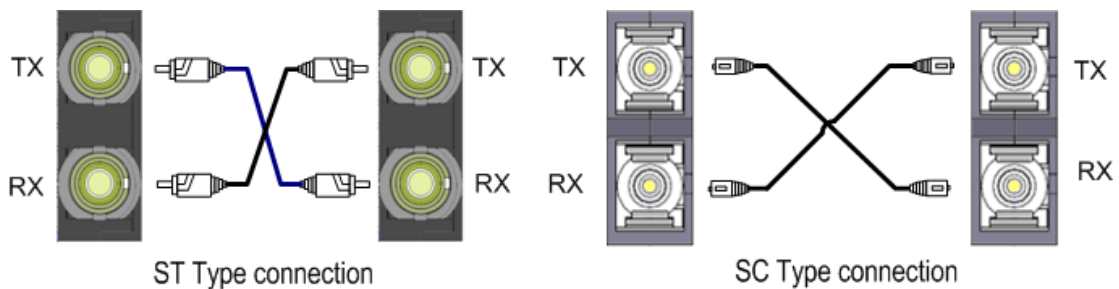

2.8 Wiring RS-232 Console Cable

There is one RS-232 DB-9 to RJ-45 cable shipped with the box. Connects the DB-9 connector to the COM port of your PC, open Terminal tool and configure the serial communication parameter to 9600, N, 8, 1. (Baud Rate: 9600bps / Parity: None / Data length: 8bits / Stop Bit: 1) Then you can access CLI interface by console able.

Note: If you lost the cable, please contact with your sales or follow the pin assignment to buy a new one. The Pin assignment spec is listed following.

RJ-45 Pin	DB-9 Pin	Description
1	8	N/A
2	9	N/A
3	2	TxD
4	1	N/A
5	5	GND
6	3	RxD
7	4	N/A
8	7	N/A

DB-9 Female Connector

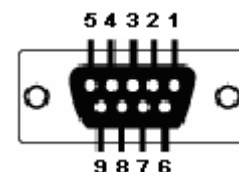

2.9 DIN-Rail Mounting Installation

The DIN-Rail clip is already screwed tight on the rear side of JetNet JetNet 4508V2/ JetNet 4508f V2 when shipping. If the DIN-Rail clip is not screwed on the JetNet 4508 V2/ JetNet 4508f V2, please contact your distributor to get the DIN rail clip set. The DIN rail clip supports EN50022 standard. In the diagram following includes the dimension of EN50022 DIN rail for your refer.

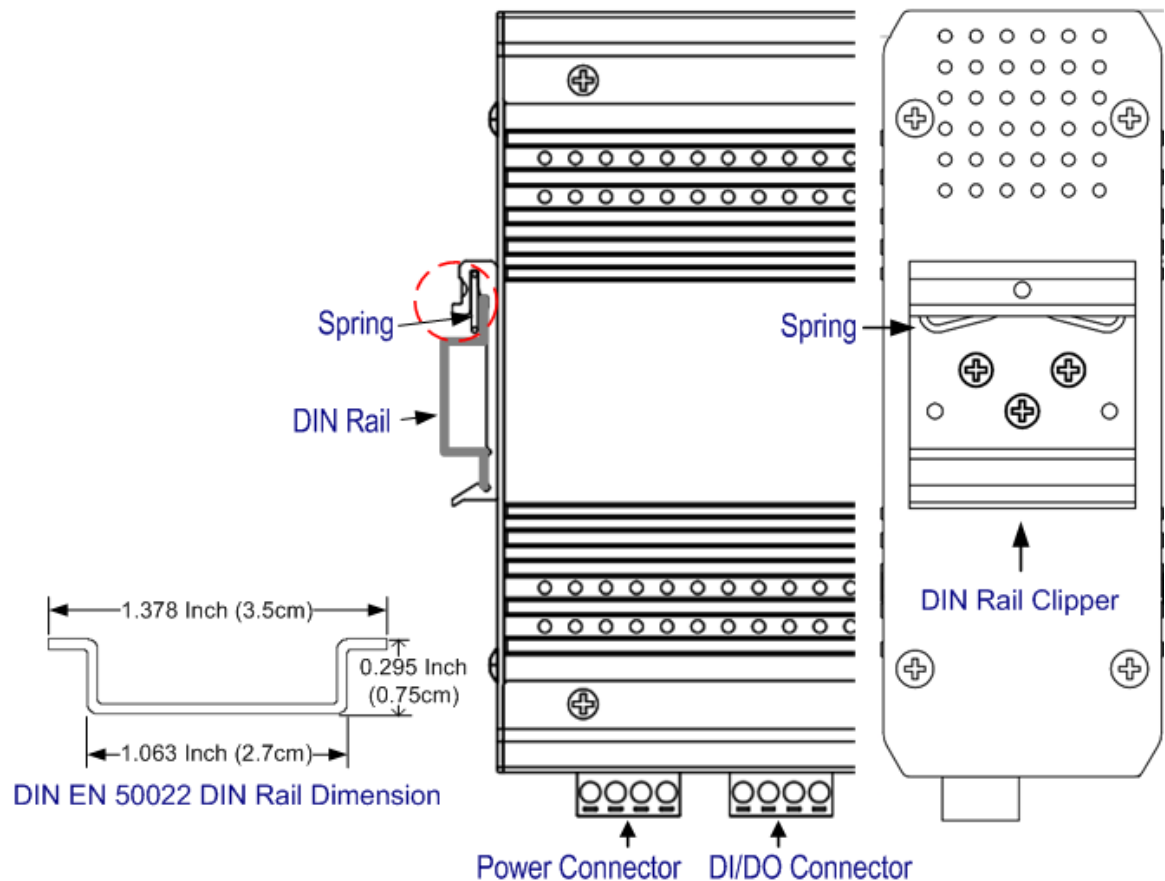

Follow the steps below to mount JetNet Managed Switch to the DIN-Rail track:

1. First, insert the DIN-Rail track upper side into the upper end of DIN-Rail clip.
2. Lightly push the bottom of DIN-Rail clip into the track.
3. Check if DIN-Rail clip is tightly attached on the track.
4. To remove JetNet 4508V2/ JetNet 4508f V2 from the track, reverse the steps above.

Notes: The DIN Rail should compliance with DIN EN50022 standard. Using wrong DIN rail may cause system install unsafe.

3 Preparation for Management

JetNet 4508/4508f series Industrial Managed Fast Ethernet Switch provides both in-band and out-band configuration methods. You can configure the switch via RS232 console port via serial cable attached in the package if you don't attach your admin PC to your network, or if you lose network connection to the target JetNet Switch. This is so-called out-band management. It wouldn't be affected by network performance.

The in-band management means you can remotely manage the switch via the Ethernet network. You can choose Telnet or Web-based management. You just need to know the device's IP address and you can remotely connect to its embedded HTTP web pages or Telnet console.

Following topics are covered in this chapter:

3.1 Preparation for Serial Console

3.2 Preparation for Web Interface

3.3 Preparation for Telnet console

3.1 Preparation for Serial Console

In package, Korenix attached one RS-232 DB-9 to RJ-45 console cable. Please attach RS-232 DB-9 connector to your PC COM port, connect RJ-45 to the Console port of the JetNet Switch. If you lose the cable, please follow the console cable PIN assignment to find one. (Refer to session 2.8).

1. Go to Start -> Program -> Accessories -> Communication -> Hyper Terminal
2. Give a name to the new console connection.
3. Choose the COM name
4. Select correct serial settings. The serial settings of JetNet switch are as below:
Baud Rate: 9600 / Parity: None / Data Bit: 8 / Stop Bit: 1
5. After connected, you can see Switch login request.
6. Login the switch. The default username is "admin", and password is "admin".

```
Boot Loader Rev 1.0.0.4 for JetNet4508fV2 (Sep  2 2010 - 17:48:54)
```

```
Loading firmware ...
```

```
Excuting firmware ...
```

```
Booting .....
```

```
....
```

```
Validate hardware : Success
```

```
System start type : Watchdog reset
```

```
Switch MAC address : 00:12:77:FF:00:00
```

```
Port6 Link Change to UP
```

```
Port5 Link Change to UP
```

```
Loading system : Success
```

```
Port5 Link Change to DOWN
```

```
RF's TestinPort5 Link Change to UP
```

```
g login:
```

3.2 Preparation for Web Interface

JetNet 4508 / 4508f provides HTTP Web Interface and Secured HTTPS Web Interface for web management. The Web user interface supports 2 languages – English and simplified Chinese, you can select language type while performs login process.

3.2.1 Web Interface

Korenix web management page is developed by JAVA. It allows you to use a standard web-browser such as Microsoft Internet Explorer, or Mozilla, to configure and interrogate the switch from anywhere on the network.

Before you attempt to use the embedded web interface to manage switch operation, verify that your JetNet 4508 V2/ 4508f V2 is properly installed on your network and that every PC on this network can access the switch via the web browser.

1. Verify that your network interface card (NIC) is operational, and that your operating system supports TCP/IP protocol.
2. Wire DC power to the switch and connect your switch to your computer.
3. Make sure that the switch default IP address is 192.168.10.1.
4. Change your computer IP address to 192.168.10.2 or other IP address which is located in the 192.168.10.x (Network Mask: 255.255.255.0) subnet.
5. Switch to DOS command mode and ping 192.168.10.1 to verify a normal response time.

Launch the web browser and Login.

6. Launch the web browser (Internet Explorer or Mozilla Firefox) on the PC.
7. Type **http://192.168.10.1** (or the IP address of the switch). And then press **Enter**.
8. The login screen will appear next.
9. Key in user name and the password. Default user name and password are both **admin**.
10. Select language type, the default is English. This feature is available from firmware v1.1.



Click on **Enter** or **OK**. Welcome page of the web-based management interface will then appear.

Once you enter the web-based management interface, you can freely change the JetNet's IP address to fit your network environment.

Note 1: IE 5.0 or later versions do not allow Java applets to open sockets by default. Users have to directly modify the browser settings to selectively enable Java applets to use network ports.

Note 2: The Web UI connection session of JetNet Switch will be logged out automatically if you don't give any input after 30 seconds. After logged out, you should re-login and key in correct user name and password again.

3.2.2 Secured Web Interface

Korenix web management page also provides secured management HTTPS login. All the configuration commands will be secured and will be hard for the hackers to sniff the login password and configuration commands.

Launch the web browser and Login.

1. Launch the web browser (Internet Explorer or Mozilla Firefox) on the PC.
2. Type **https://192.168.10.1** (or the IP address of the switch). And then press **Enter**.
3. The popup screen will appear and request you to trust the secured HTTPS connection distributed by JetNet 4508 V2/JetNet 4508f V2 first. Press **Yes** to trust it. (Uses JeNet 5010G sample)



4. The login screen will appear next.

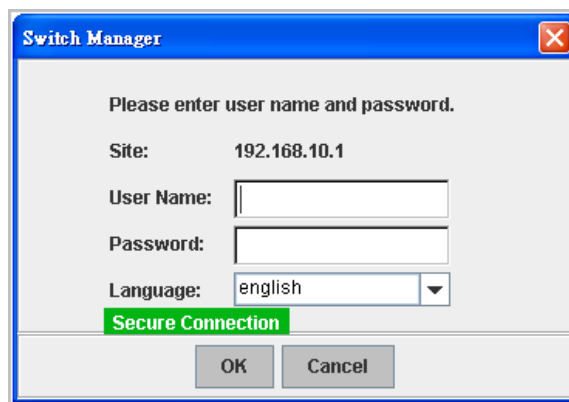

5. Key in the user name and the password. The default user name and password is **admin**.
6. Click on **Enter** or **OK**. Welcome page of the web-based management interface will then appear.
7. Once you enter the web-based management interface, all the commands you see are the same as what you see by HTTP login.

3.3 Preparation for Telnet Console

3.3.1 Telnet

Korenix Managed Switch supports Telnet console. You can connect to the switch by Telnet and the command lines are the same as what you see by RS-232 console port. Below are the steps to open Telnet connection to the switch.

1. Go to Start -> Run -> cmd. And then press **Enter**
2. Type the **Telnet 192.168.10.1** (or the IP address of the switch). And then press **Enter**

3.3.2 SSH (Secure Shell)

Korenix Managed Switch also support SSH console. You can remotely connect to the switch by command line interface. The SSH connection can secure all the configuration commands you sent to the switch.

SSH is a client/server architecture while the Switch is the SSH server. When you want to make SSH connection with the switch, you should download the SSH client tool first.

SSH Client

There are many free, sharewares, trials or charged SSH clients you can find on the internet. For example, PuTTY is a free and popular Telnet/SSH client. We'll use this tool to demonstrate how to login JetNet by SSH. Note: *PuTTY is copyright 1997-2006 Simon Tatham.*

Download PuTTY:

<http://www.chiark.greenend.org.uk/~sgtatham/putty/download.html>

The copyright of **PuTTY**

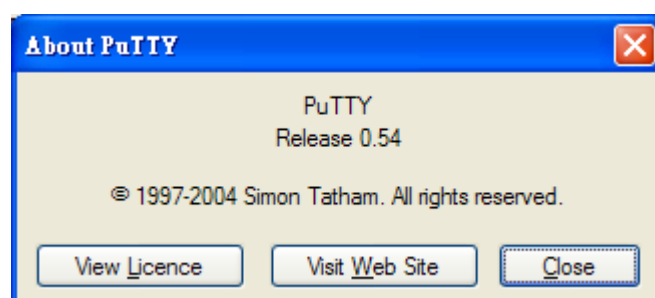

1. Open SSH Client/PuTTY

In the **Session** configuration, enter the **Host Name** (IP Address of your JetNet Switch) and **Port number** (default = 22). Choose the “**SSH**” protocol. Then click on “**Open**” to start the SSH session console.

(The sample’s IP address is 192.168.10.13)

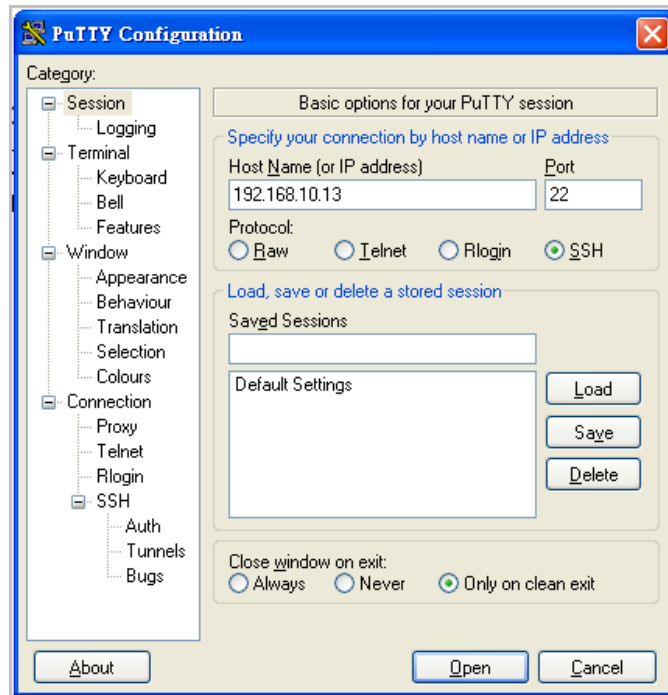

2. After click on **Open**, then you can see the cipher information in the popup screen. Press **Yes** to accept the Security Alert.

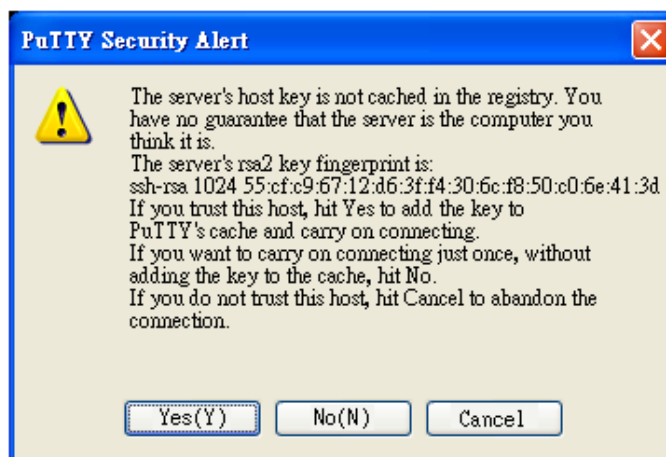

3. After few seconds, the SSH connection to Switch is opened. You can see the login screen as the below figure.

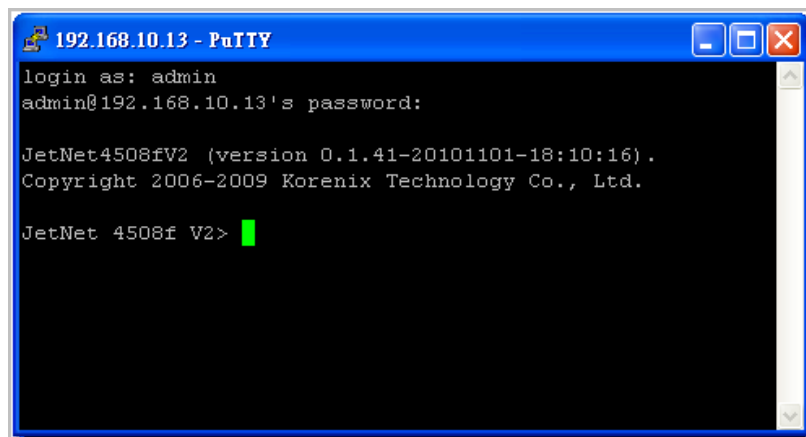

```
192.168.10.13 - PuTTY
login as: admin
admin@192.168.10.13's password:

JetNet4508fV2 (version 0.1.41-20101101-18:10:16).
Copyright 2006-2009 Korenix Technology Co., Ltd.

JetNet 4508f V2>
```

4. Type the Login Name and its Password. The default Login Name and Password are **admin / admin**.
5. All the commands you see in SSH are the same as the CLI commands you see via RS232 console. The next chapter will introduce in detail how to use command line to configure the switch.

4 Feature Configuration

This chapter explains how to configure the software features. There are four ways to access the switch: Serial console, Telnet, Web browser and SNMP.

The Industrial Managed Switch provides both in-band and out-band configuration methods. You can configure the switch via RS-232 console cable if you don't attach your admin PC to your network, or if you lose the network connection to your JetNet JetNet 4508 V2/JetNet 4508f V2. This is so-called out-band management. It wouldn't be affected by the network performance.

The in-band management means you can remotely manage the switch via the network. You can choose Telnet or Web-based management. You just need to know the device's IP address. Then you can remotely connect to its embedded HTML web pages or Telnet console.

Korenix web management page is developed by JAVA. It allows you to use a standard web-browser such as Microsoft Internet Explorer, or Mozilla, to configure and interrogate the switch from anywhere on the network.

Note: IE 5.0 or later versions do not allow Java applets to open sockets by default. Users have to directly modify the browser settings to selectively enable Java applets to use network ports.

Following topics are covered in this chapter:

- 4.1 Command Line Interface (CLI) Introduction
- 4.2 Basic Setting
- 4.3 Port Configuration
- 4.4 Network Redundancy
- 4.5 VLAN
- 4.6 Traffic Prioritization
- 4.7 Multicast Filtering
- 4.8 SNMP
- 4.9 Security
- 4.10 Warning
- 4.11 Monitor and Diag
- 4.12 Device Front Panel
- 4.13 Save
- 4.14 Logout

4.1 Command Line Interface Introduction

The Command Line Interface (CLI) is the user interface to the switch's embedded software system. You can view the system information, show the status, configure the switch and receive a response back from the system by keying in a command.

There are some different command modes. Each command mode has its own access ability, available command lines and uses different command lines to enter and exit. These modes are User EXEC, Privileged EXEC, Global Configuration, (Port/VLAN) Interface Configuration modes.

User EXEC mode: As long as you login the switch by CLI. You are in the User EXEC mode. You can ping, telnet remote device, and show some basic information.

Type **enable** to enter next mode, **exit** to logout. **?** to see the command list

Switch>	
enable	Turn on privileged mode command
exit	Exit current mode and down to previous mode
list	Print command list
ping	Send echo messages
quit	Exit current mode and down to previous mode
show	Show running system information
telnet	Open a telnet connection
traceroute	Trace route to destination

Privileged EXEC mode: Press enable in the User EXEC mode, then you can enter the Privileged EXEC mode. In this mode, the system allows you to view current configuration, reset default, reload switch, show system information, save configuration...and enter the global configuration mode.

Type **configure terminal** to enter next mode, **exit** to leave. **?** to see the command list

Switch#	
archive	manage archive files
clear	Reset functions
clock	Configure time-of-day clock
configure	Configuration from vty interface
copy	Copy from one file to another
debug	Debugging functions (see also 'undebug')
disable	Turn off privileged mode command
end	End current mode and change to enable mode
exit	Exit current mode and down to previous mode
list	Print command list
more	Display the contents of a file
no	Negate a command or set its defaults
ping	Send echo messages
quit	Exit current mode and down to previous mode
reboot	Reboot system
reload	copy a default-config file to replace the current one
show	Show running system information
telnet	Open a telnet connection
terminal	Set terminal line parameters
traceroute	Trace route to destination
write	Write running configuration to memory, network, or terminal

Global Configuration Mode: Press **configure terminal** in privileged EXEC mode. You can then enter global configuration mode. In global configuration mode, you can configure all the features that the system provides you.

Type **interface IFNAME/VLAN** to enter interface configuration mode, **exit** to leave this configuration level and **?** to list all of commands.

Available command lists of global configuration mode.

Switch# configure terminal	
Switch(config)#	
access-list	Add an access list entry
administrator	Administrator account setting
arp	Set a static ARP entry
clock	Configure time-of-day clock
default	Set a command to its defaults
end	End current mode and change to enable mode
exit	Exit current mode and down to previous mode
gvrp	GARP VLAN Registration Protocol
hostname	Set system's network name
interface	Select an interface to configure
ip	IP information
lacp	Link Aggregation Control Protocol
list	Print command list
log	Logging control
mac	Global MAC configuration subcommands
mac-address-table	mac address table
mirror	Port mirroring
no	Negate a command or set its defaults
ntp	Configure NTP
password	Assign the terminal connection password
qos	Quality of Service (QoS)
relay	relay output type information
smtp-server	SMTP server configuration
snmp-server	SNMP server
spanning-tree	spanning tree algorithm
super-ring	super-ring protocol
trunk	Trunk group configuration
vlan	Virtual LAN
warning-event	Warning event selection
write-config	Specify config files to write to

(Port) Interface Configuration: Press **interface IFNAME** in global configuration mode. You can then enter interface configuration mode. In this mode, you can configure port settings.

The port interface name for Fast Ethernet port 1~8 are fa1~fa8. Typing in the interface name accordingly when you want to enter certain interface configuration mode.

Type **exit** to leave this current level.

Type **?** to show the command list

Available command lists of the global configuration mode.

Switch(config)# interface fa1	
Switch(config-if)#	
acceptable	Configure 802.1Q acceptable frame types of a port.
auto-negotiation	Enable auto-negotiation state of a given port
description	Interface specific description
duplex	Specify duplex mode of operation for a port
end	End current mode and change to enable mode
exit	Exit current mode and down to previous mode
flowcontrol	Set flow-control value for an interface
garp	General Attribute Registration Protocol
ingress	802.1Q ingress filtering features
lacp	Link Aggregation Control Protocol
list	Print command list
loopback	Specify loopback mode of operation for a port
mac	MAC interface commands
mdix	Enable mdix state of a given port
no	Negate a command or set its defaults
qos	Quality of Service (QoS)
quit	Exit current mode and down to previous mode
rate-limit	Rate limit configuration
shutdown	Shutdown the selected interface
spanning-tree	spanning-tree protocol
speed	Specify the speed of a Fast Ethernet port or a Gigabit
Ethernet port.	
switchport	Set switching mode characteristics

(VLAN) Interface Configuration: Press **interface VLAN VLAN-ID** in global configuration mode. You can then enter VLAN interface configuration mode. In this mode, you can configure the settings for the specific VLAN.

The VLAN interface name of VLAN 1 is VLAN 1, VLAN 2 is VLAN 2...

Type **exit** to leave the mode. Type **?** to see the available command list.

The command lists of the VLAN interface configuration mode.

Switch(config)# interface vlan 1	
Switch(config-if)#	
description	Interface specific description
end	End current mode and change to enable mode
exit	Exit current mode and down to previous mode
ip	Interface Internet Protocol config commands
list	Print command list
no	Negate a command or set its defaults
quit	Exit current mode and down to previous mode
shutdown	Shutdown the selected interface

Summary of the 5 command modes.

Command Mode	Main Function	Enter and Exit Method	Prompt
User EXEC	This is the first level of access. User can ping, telnet remote device, and show some basic information	Enter: Login successfully Exit: exit to logout. Next mode: Type enable to enter privileged EXEC mode.	Switch>
Privileged EXEC	In this mode, the system allows you to view current configuration, reset default, reload switch, show system information, save configuration...and enter global configuration mode.	Enter: Type enable in User EXEC mode. Exec: Type disable to exit to user EXEC mode. Type exit to logout Next Mode: Type configure terminal to enter global configuration command.	Switch#
Global configuration	In global configuration mode, you can configure all the features that the system provides you	Enter: Type configure terminal in privileged EXEC mode Exit: Type exit or end or press Ctrl-Z to exit. Next mode: Type interface IFNAME/ VLAN VID to enter interface configuration mode	Switch(config)#
Port Interface configuration	In this mode, you can configure port related settings.	Enter: Type interface IFNAME in global configuration mode. Exit: Type exit or Ctrl+Z to global configuration mode. Type end to privileged EXEC mode.	Switch(config-if)#
VLAN Interface Configuration	In this mode, you can configure settings for specific VLAN.	Enter: Type interface VLAN VID in global configuration mode. Exit: Type exit or Ctrl+Z to global configuration mode. Type end to privileged EXEC mode.	Switch(config-vlan)#

Here are some useful commands for you to see these available commands. Save your time in typing and avoid typing error.

? To see all the available commands in this mode. It helps you to see the next command you can/should type as well.

```
Switch(config)# interface ?
IFNAME  Interface's name
vlan    Select a vlan to configure
```

(Character) ? To see all the available commands starts from this character.

```
Switch(config)# a?
access-list  Add an access list entry
administrator Administrator account setting
arp          Set a static ARP entry
```

Tab This tab key helps you to input the command quicker. If there is only one available command in the next, clicking on tab key can help to finish typing soon.

```
Switch# co (tab) (tab)
Switch# configure terminal

Switch(config)# ac (tab)
Switch(config)# access-list
```

Ctrl+C To stop executing the unfinished command.

Ctrl+S To lock the screen of the terminal. You can't input any command.

Ctrl+Q To unlock the screen which is locked by Ctrl+S.

Ctrl+Z To exit configuration mode.

Alert message when multiple users want to configure the switch. If the administrator is in configuration mode, then the Web users can't change the settings. JetNet 4508 / 4508f allows only one administrator to configure the switch at same time.

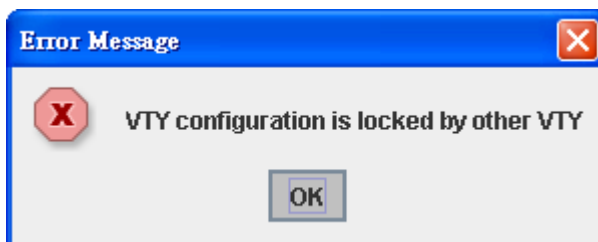

4.2 Basic Setting

The Basic Setting group provides you to configure switch information, IP address, User's name/Password of the system. It also allows you to do firmware upgrade, backup and restore configuration, reload factory default, and reboot the system.

Following commands are included in this group:

- 4.2.1 Switch Setting
- 4.2.2 Admin Password
- 4.2.3 IP Configuration
- 4.2.4 Time Setting
- 4.2.5 DHCP Server
- 4.2.6 Backup and Restore
- 4.2.7 Firmware Upgrade
- 4.2.8 Factory Default
- 4.2.9 System Reboot
- 4.2.10 CLI Commands for Basic Setting

4.2.1 Switch Setting

You can assign System name, Location, Contact and view system information.

Figure 4.2.1.1 – Web UI of the Switch Setting

Your Industrial Computing & Networking Partner	
System Name	JetNet 4508f V2
System Location	PM-Richard
System Contact	PM-Richard ext 200
System OID	1.3.6.1.4.1.24062.2.2.18
System Description	JetNet4508fV2 Industrial Managed Switch
Firmware Version	v0.1.41 20101101
MAC Address	00:12:77:ff:00:00
Product Name	JetNet4508fV2
Serial Number	
Manufacturing Date	

(Sampling device setting for System Location is “PM-Richard” and System Contact is “PM-Richard ext200)

System Name: You can assign a meaningful name to the device. The available characters you can input is 64. After you configure the name, CLI system will select the first 12 characters as the name in CLI system.

System Location: You can specify the switch's physical location here. The available characters you can input are 64.

System Contact: You can specify contact people here. You can type the name, mail address or other information of the administrator. The available characters you can input are 64.

System OID: The SNMP object ID of the switch. You can follow the path to find its private MIB in MIB browser. (**Note:** When you attempt to view private MIB, you should compile private MIB files into your MIB browser first.)

System Description: the real product model name of this product.

Firmware Version: Display the firmware version installed in this device.

MAC Address: Display unique hardware address (MAC address) assigned by the manufacturer.

Product Name: Display the Switch's model name

Serial Number: Display the Switch's serial number

Manufacture Date: Display the switch's production date.

Once you finish the configuration, click on **Apply** to apply your settings.

Note: Always remember to select **Save** to save your settings. Otherwise, the settings you made will be lost when the switch is powered off.

4.2.2 Admin Password

You can change the user name and the password here to enhance security

Figure 4.2.2.1 Web UI of the Admin Password

Admin Password	
Name	admin
Password
Confirm Password
<input type="button" value="Apply"/>	

Name: You can key in new user name here. The default setting is **admin**.

Password: You can key in new password here. The default setting is **admin**.

Confirm Password: You need to type the new password again to confirm it.

Once you finish configuring the settings, click on **Apply** to apply your configuration.

Figure 4.2.2.2 Popup alert window for Incorrect Username.

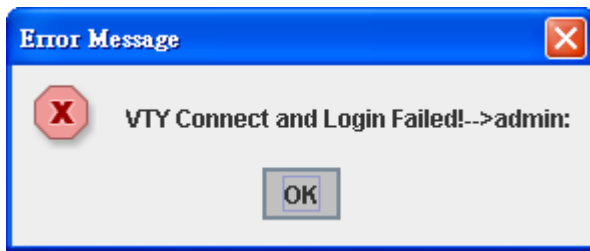

4.2.3 IP Configuration

This function allows users to configure the switch's IP address settings.

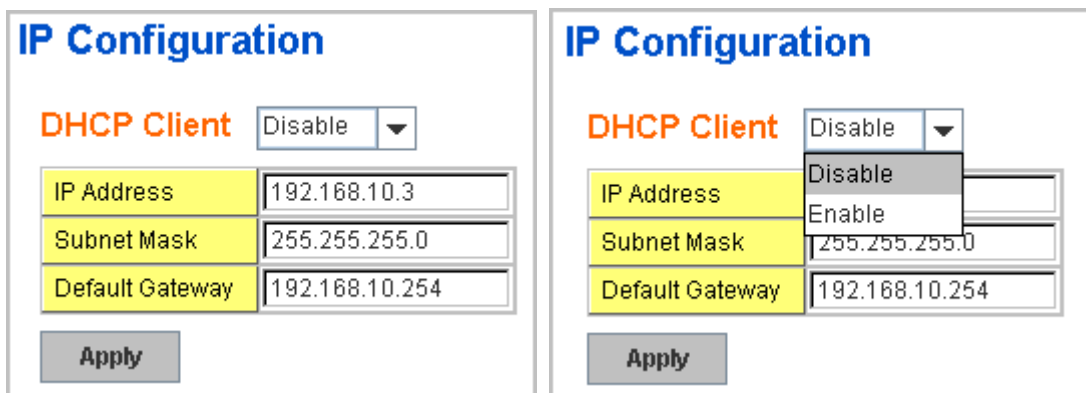

DHCP Client: You can select to **Enable** or **Disable** DHCP Client function. When DHCP Client function is enabled, an IP address will be assigned to the switch from the network's DHCP server. In this mode, the default IP address will therefore be replaced by the one assigned by DHCP server. If DHCP Client is disabled, then the IP address that you specified will be used instead.

IP Address: You can assign the IP address reserved by your network for your JetNet. If DHCP Client function is enabled, you don't need to assign an IP address to the JetNet, as it will be overwritten by DHCP server and shown here. The default IP is 192.168.10.1.

Subnet Mask: You can assign the subnet mask for the IP address here. If DHCP Client function is enabled, you don't need to assign the subnet mask. The default Subnet Mask is 255.255.255.0. **Note:** In the CLI, we use the enabled bit of the subnet mask to represent the number displayed in web UI. For example, 8 stands for 255.0.0.0; 16 stands for 255.255.0.0; 24 stands for 255.255.255.0.

Default Gateway: You can assign the gateway for the switch here. The default gateway is 192.168.10.254. **Note:** In CLI, we use 0.0.0.0/0 to represent for the default gateway.

Once you finish configuring the settings, click on **Apply** to apply your configuration.

4.2.4 Time Setting

Time Setting source allow user to set the time manually or through NTP server. Network Time Protocol (NTP) is used to synchronize computer clocks on the internet. You can configure NTP settings here to synchronize the clocks of several switches on the network.

The IEEE1588 PTP (Precision Time Protocol) supports very precise time synchronization in an Ethernet network. There are two clocks, Master and Slave. The master device periodically launches an exchange of messages with slave devices to help each slave clock re-compute the offset between its clock and the master's clock.

*Note: Please enable one synchronization protocol (PTP/NTP) only.

The JetNet Switch also provides Daylight Saving function for some territories use.

Time Setting

System Time: Thu Jan 1 00:07:36 2009

Time Setting Source	Manual Setting
Manual Setting	Get Time From PC
Jan	01, 2009 00 : 07 : 36

IEEE 1588	
PTP State	Disable
Mode	Auto

Timezone Setting	
Timezone	(GMT-07:00) Mountain Time (US & Canada)

<input type="checkbox"/> Daylight Saving Time	
Daylight Saving Start	2nd Sun in Jun at 00 : 00
Daylight Saving End	4th Sat in Sep at 00 : 00

Manual Setting: User can select Manual setting to change time as user wants. User also can click the button “**Get Time from PC**” to get PC’s time setting for switch.

NTP client: Select the Time Setting Source to **NTP client** can let device enable the NTP client service. NTP client will be automatically enabled if you change Time source to NTP Client. The system will send request packet to acquire

current time from the NTP server you assigned.

Time Setting Source	NTP Client
NTP Client	Manual Setting
Primary Server Address	NTP Client
	192.168.10.120
Secondary Server Address	192.168.10.121

IEEE 1588: select the **PTP State** to enable this function and select one operating mode for the precision time synchronizes.

Auto mode: the switch performs PTP Master and slave mode (Boundary mode)

Master mode: switch performs PTP Master only.

Slave mode: switch performs PTP slave only.

IEEE 1588	
PTP State	Enable
Mode	Auto
Timezone Setting	
Timezone	(GMT) Greenwich Mean Time

Time-zone: Select the time zone where the switch is located. Following table lists the time zones for different locations for your reference. The default time zone is GMT Greenwich Mean Time.

- ```
Switch(config)# clock timezone
01 (GMT-12:00) Eniwetok, Kwajalein
02 (GMT-11:00) Midway Island, Samoa
03 (GMT-10:00) Hawaii
04 (GMT-09:00) Alaska
05 (GMT-08:00) Pacific Time (US & Canada) , Tijuana
06 (GMT-07:00) Arizona
07 (GMT-07:00) Mountain Time (US & Canada)
08 (GMT-06:00) Central America
09 (GMT-06:00) Central Time (US & Canada)
10 (GMT-06:00) Mexico City
11 (GMT-06:00) Saskatchewan
12 (GMT-05:00) Bogota, Lima, Quito
13 (GMT-05:00) Eastern Time (US & Canada)
14 (GMT-05:00) Indiana (East)
15 (GMT-04:00) Atlantic Time (Canada)
16 (GMT-04:00) Caracas, La Paz
17 (GMT-04:00) Santiago
18 (GMT-03:00) Newfoundland
19 (GMT-03:00) Brasilia
20 (GMT-03:00) Buenos Aires, Georgetown
21 (GMT-03:00) Greenland
```

- 22 (GMT-02:00) Mid-Atlantic
- 23 (GMT-01:00) Azores
- 24 (GMT-01:00) Cape Verde Is.
- 25 (GMT) Casablanca, Monrovia
- 26 (GMT) Greenwich Mean Time: Dublin, Edinburgh, Lisbon, London
- 27 (GMT+01:00) Amsterdam, Berlin, Bern, Rome, Stockholm, Vienna
- 28 (GMT+01:00) Belgrade, Bratislava, Budapest, Ljubljana, Prague
- 29 (GMT+01:00) Brussels, Copenhagen, Madrid, Paris
- 30 (GMT+01:00) Sarajevo, Skopje, Sofija, Vilnius, Warsaw, Zagreb
- 31 (GMT+01:00) West Central Africa
- 32 (GMT+02:00) Athens, Istanbul, Minsk
- 33 (GMT+02:00) Bucharest
- 34 (GMT+02:00) Cairo
- 35 (GMT+02:00) Harare, Pretoria
- 36 (GMT+02:00) Helsinki, Riga, Tallinn
- 37 (GMT+02:00) Jerusalem
- 38 (GMT+03:00) Baghdad
- 39 (GMT+03:00) Kuwait, Riyadh
- 40 (GMT+03:00) Moscow, St. Petersburg, Volgograd
- 41 (GMT+03:00) Nairobi
- 42 (GMT+03:30) Tehran
- 43 (GMT+04:00) Abu Dhabi, Muscat
- 44 (GMT+04:00) Baku, Tbilisi, Yerevan
- 45 (GMT+04:30) Kabul
- 46 (GMT+05:00) Ekaterinburg
- 47 (GMT+05:00) Islamabad, Karachi, Tashkent
- 48 (GMT+05:30) Calcutta, Chennai, Mumbai, New Delhi
- 49 (GMT+05:45) Kathmandu
- 50 (GMT+06:00) Almaty, Novosibirsk
- 51 (GMT+06:00) Astana, Dhaka
- 52 (GMT+06:00) Sri Jayawardenepura
- 53 (GMT+06:30) Rangoon
- 54 (GMT+07:00) Bangkok, Hanoi, Jakarta
- 55 (GMT+07:00) Krasnoyarsk
- 56 (GMT+08:00) Beijing, Chongqing, Hong Kong, Urumqi
- 57 (GMT+08:00) Irkutsk, Ulaan Bataar
- 58 (GMT+08:00) Kuala Lumpur, Singapore
- 59 (GMT+08:00) Perth
- 60 (GMT+08:00) Taipei
- 61 (GMT+09:00) Osaka, Sapporo, Tokyo
- 62 (GMT+09:00) Seoul
- 63 (GMT+09:00) Yakutsk
- 64 (GMT+09:30) Adelaide
- 65 (GMT+09:30) Darwin
- 66 (GMT+10:00) Brisbane
- 67 (GMT+10:00) Canberra, Melbourne, Sydney
- 68 (GMT+10:00) Guam, Port Moresby
- 69 (GMT+10:00) Hobart
- 70 (GMT+10:00) Vladivostok
- 71 (GMT+11:00) Magadan, Solomon Is., New Caledonia
- 72 (GMT+12:00) Auckland, Wellington
- 73 (GMT+12:00) Fiji, Kamchatka, Marshall Is.
- 74 (GMT+13:00) Nuku'alofa

**Daylight Saving Time:** click the check box to enable the Daylight Saving Function as the setting of start and end time or disable it.

**Daylight Saving Start** and **Daylight Saving End**: the time setting allows user to select the week that monthly basis, and sets the End and Start time individually.

Once you finish those configurations, click on **Apply** to apply your configuration.

## 4.2.5 DHCP Server

You can select to **Enable** or **Disable** DHCP Server function. *The Switch* will assign a new IP address to link partners, and also supports DHCP server option 82 with forwarding policy, and provides port-based DHCP server with IP address binding feature.

### DHCP Server configuration

After selecting to enable DHCP Server function, type in the Network IP address for the DHCP server IP pool, Subnet Mask, Default Gateway address and Lease Time for client.

DHCP Server

### DHCP Server Configuration

|                 |                                            |
|-----------------|--------------------------------------------|
| Network         | <input type="text" value="192.168.10.0"/>  |
| Subnet Mask     | <input type="text" value="255.255.255.0"/> |
| Default Gateway | <input type="text" value="192.168.10.1"/>  |
| Lease Time(s)   | <input type="text" value="604800"/>        |

Once you have finished the configuration, click **Apply** to apply your configuration

### Excluded Address:

You can type a specific address into the **IP Address field** for the DHCP server reserved IP address.

The IP address that is listed in the **Excluded Address List Table** will not be assigned to the network device. Add or remove an IP address from the **Excluded Address List** by clicking **Add** or **Remove**.

### Excluded Address

IP Address

### Excluded Address List

| Index | IP Address     |
|-------|----------------|
| 1     | 192.168.10.200 |
|       |                |

**Manual Binding:** *it* provides a MAC address and IP address binding and removing function. You can type in the specified IP and MAC address, and then click **Add** to add a new MAC&IP address binding rule for a specified link partner, like PLC or any device without **DHCP client** function. To remove from the binding list, just select the rule to remove and click **Remove**.

### Manual Binding

|             |                                             |
|-------------|---------------------------------------------|
| IP Address  | <input type="text" value="192.168.10.201"/> |
| MAC Address | <input type="text" value="0012.7760.aaa1"/> |

### Manual Binding List

| Index | IP Address     | MAC Address    |   |
|-------|----------------|----------------|---|
| 1     | 192.168.10.200 | 0012.7760.aaaa | ▲ |
|       |                |                |   |

**DHCP Leased Entries:** *it* provides an assigned IP address list for user check. It will show the MAC and IP address that was assigned by *Switch*. Click the **Reload** button to refresh the listing.

### DHCP Leased Entries

| Index | Binding | IP Address     | MAC Address    | Lease Time(s) |   |
|-------|---------|----------------|----------------|---------------|---|
| 1     | Auto    | 192.168.10.200 | 0012.7760.aaaa | 604509        | ▲ |
|       |         |                |                |               |   |

**Option 82 IP Address Configuration:** the DHCP server with option 82 function presented in firmware V1.1 after. This feature support fully DHCP relay function, and allows user to configrue relay circuit ID, Remote ID to compliant fully DHCP option 82 function.

**Port and IP Address:** after firmware version v1.2, the JetNet managed PoE Switch support port-based DHCP server function. It allows user assign specified IP address to specified port that DHCP client presented; and the DHCP server only reply and offer the specified IP address to the DHCP client if it request IP address.

### Option82 IP Address Configuration

IP Address

Circuit ID

Remote ID

Add

| IP Address | Circuit ID | Type | Remote ID |
|------------|------------|------|-----------|
|            |            |      |           |

Remove    Reload

### Port and IP Address

Port

IP Address

Add

| Port | IP Address |
|------|------------|
|      |            |

Remove    Reload

**DHCP Leased Entries: the Managed Switch** provides an assigned IP address list for user check. It will show the MAC and IP address that was assigned by **Managed Switch**. Click the **Reload** button to refresh the listing.

### DHCP Leased Entries

| Index | Binding | IP Address  | MAC Address    | Lease Time(s) |
|-------|---------|-------------|----------------|---------------|
| 1     | Auto    | 192.168.0.3 | 0012.77ff.0530 | 604785        |

Reload

## DHCP Relay Agent

You can select to **Enable** or **Disable** DHCP relay agent function, and then select the modification type of option 82 field, circuit ID, remote ID.

**Relay policy drop:** Drops the option 82 field and do not add any option 82 field.

**Relay policy keep:** Keeps the original option 82 field and forwards to server.

**Relay policy replace:** Replaces the existing option 82 field and adds new DHCP option 82 field. (This is the default setting)

**Helper Address:** there are 4 fields for the DHCP server’s IP address. You can fill the field with preferred IP address of DHCP Server, and then click “Apply” to activate the DHCP relay agent function. All the DHCP packets from client will be modified by the policy and forwarded to DHCP server through the gateway port.

### 4.2.6 Backup and Restore

With Backup command, you can save current configuration file saved in the switch’s flash to admin PC or TFTP server. This will allow you to go to **Restore** command later to restore the configuration file back to the switch. Before you restore the configuration file, you must place the backup configuration file in the PC or TFTP server. The switch will then download this file back to the flash.

There are 2 modes for users to backup/restore the configuration file, Local File mode and TFTP Server mode.

**Local File** mode: In this mode, the switch acts as the file server. Users can browse the target folder and then type the file name to backup the configuration. Users can also browse the target folder and select existed configuration file to restore the configuration back to the switch. This mode is only provided by Web UI while CLI is not supported.

**TFTP Server** mode: In this mode, the switch acts as TFTP client. Before you do so, make sure that your TFTP server is ready. Then please type the IP address of TFTP Server and Backup configuration file name. This mode can be used in both CLI and Web UI.



**TFTP Server IP Address:** You need to key in the IP address of your TFTP Server here.

**Backup/Restore File Name:** Please type the correct file name of the configuration file..

**Configuration File:** The configuration file of the switch is a pure text file. You can open it by word/txt read file. You can also modify the file, add/remove the configuration settings, and then restore back to the switch.

**Startup Configuration File:** After you saved the running-config to flash, the new settings will be kept and work after power cycle. You can use *show startup-config* to view it in CLI. The Backup command can only backup such configuration file to your PC or TFTP server.

**Technical Tip:**

**Default Configuration File:** The switch provides the default configuration file in the system. You can use Reset button, Reload command to reset the system.

**Running Configuration File:** The switch's CLI allows you to view the latest settings running by the system. The information shown here is the settings you set up but haven't saved to flash. The settings not yet saved to flash will not work after power recycle. You can use *show running-config* to view it in CLI.

Figure 4.2.6.1 Main UI of Backup & Restore

## Backup & Restore

**Backup Configuration** Local File ▼

Backup File Name D:\TFTP\backup.con 

Backup

**Restore Configuration** TFTP Server ▼

TFTP Server IP 192.168.0.100

Restore File Name backup.conf

Restore

Figure 4.2.6.2 Bacup/Restore Configuration - Local File mode.

**Backup Configuration** Local File ▼

Backup File Name 0.30w0.30\Quagga1.conf 

Backup Help



Click on Folder icon to select the target file you want to backup/restore.

**Note** that the folders of the path to the target file do not allow you to input space key.

Figure 4.2.6.3 Backup/Restore Configuration - TFTP Server mode

**Backup Configuration** TFTP Server ▼

TFTP Server IP 192.168.0.100

Backup File Name Backup1.conf

Backup

Type the IP address of TFTP Server IP. Then click on **Backup/Restore**.

**Note:** point to the wrong file will cause the entire configuration missed

## 4.2.7 Firmware Upgrade

In this section, you can update the latest firmware for your switch. Korenix provides the latest firmware in Korenix Web site. The new firmware may include new features, bug fixes or other software changes. We'll also provide the release notes for the update as well. For technical viewpoint, we suggest you use the latest firmware before installing the switch to the customer site.

**Note: the system will automatically reboot after you finished upgrading new firmware. Please remind the attached users before you do that.**

Figure 4.2.7.1 Main UI of Firmware Upgrade



Your Industrial Computing & Networking Partner

### Firmware Upgrade

System Firmware Version: v1.2  
System Firmware Date: 20070620

**Firmware Upgrade** Local File

Firmware File Name TPJetNet5010G-v1.2.bin

Note: When firmware upgrade is finished, the switch will restart automatically.

Upgrade

Sample Web UI of JetNet 5010G firmware upgrade

There are 2 modes for users to backup/restore the configuration file, Local File mode and TFTP Server mode.

**Local File** mode: In this mode, the switch acts as the file server. Users can browse the target folder and then type the file name to backup the configuration. Users also can browse the target folder and select the existed configuration file to restore the configuration back to the switch. This mode is only provided by Web UI while CLI is not supported.

**TFTP Server** mode: In this mode, the switch acts as the TFTP client. Before you do so, make sure that your TFTP server is ready. And then please type the IP address of TFTP Server IP address. This mode can be used in both CLI and Web UI.

**TFTP Server IP Address:** You need to key in the IP address of your TFTP Server here.

**Firmware File Name:** The file name of the new firmware.  
The UI also shows you the current firmware version and built date of current firmware. Please check the version number after the switch is rebooted.

Figure 4.2.7.2 Firmware Upgrade - Local File mode.

## Firmware Upgrade

System Firmware Version: v1.2  
System Firmware Date: 20070620

**Firmware Upgrade** Local File ▼

|                    |                        |
|--------------------|------------------------|
| Firmware File Name | TPJetNet5010G-v1.2.bin |
|--------------------|------------------------|

Note: When firmware upgrade is finished, the switch will restart automatically.

**Upgrade**



Click on Folder icon to select the target firmware file you want to upgrade.

Figure 4.2.7.3 Firmware Upgrade – TFTP Server mode.

## Firmware Upgrade

System Firmware Version: v1.2  
System Firmware Date: 20070620

**Firmware Upgrade** TFTP Server ▼

|                    |                      |
|--------------------|----------------------|
| TFTP Server IP     | 192.168.0.100        |
| Firmware File Name | JetNet5010G-v1.2.bin |

Note: When firmware upgrade is finished, the switch will restart automatically.

**Upgrade**

Type the IP address of TFTP Server and Firmware File Name. Then click on **Upgrade** to start the process.

After finishing transmitting the firmware, the system will copy the firmware file and replace the firmware in the flash. The CLI show ..... until the process is finished.

## 4.2.8 Factory Default

In this section, you can reset all the configurations of the switch to default setting. Click on **Reset** the system will then reset all configurations to default setting. The system will show you pop-up message window after finishing this command. Default setting will work after rebooting the switch.

Figure- 4.2.8.1 The main screen of the Reset to Default

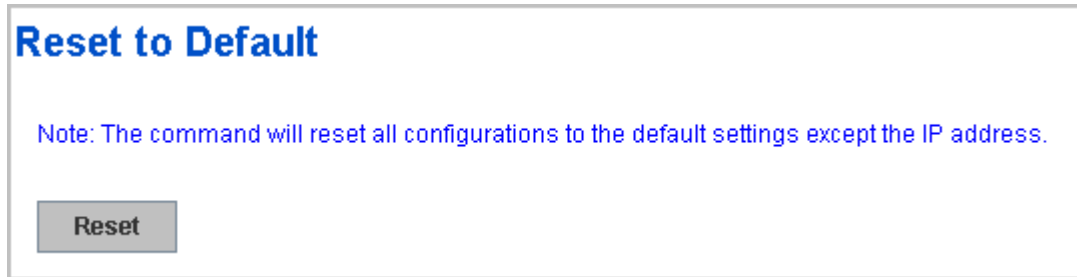

Figure 4.2.8.2 Popup alert screen to confirm the command. Click on **Yes** to start it.

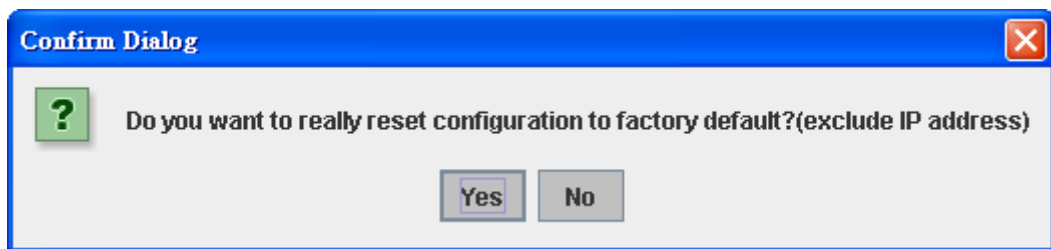
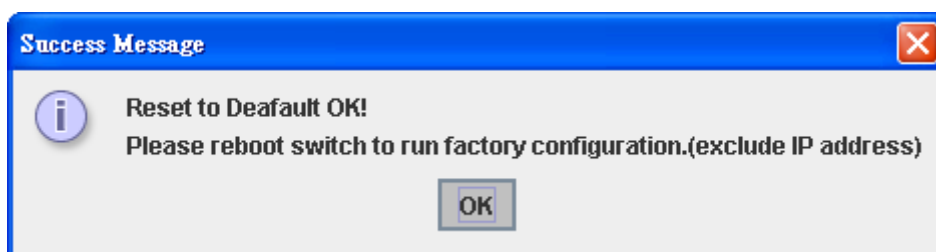

Figure 4.2.8.3 Popup message screen to show you that have done the command. Click on **OK** to close the screen. Then please go to **Reboot** page to reboot the switch.





Click on **OK**. The system will then auto reboot the device.

Note: If you already configured the IP of your device to other IP address, when you use this command by CLI and Web UI, our software will not reset the IP address to default IP. The system will remain the IP address so that you can still connect the switch via the network.

## 4.2.9 System Reboot

System Reboot allows you to reboot the device. Some of the feature changes require you to reboot the system. Click on **Reboot** to reboot your device.

**Note:** Remember to click on **Save** button to save your settings. Otherwise, the settings you made will be gone when the switch is powered off.

Figure 4.2.9.1 Main screen for Rebooting



Figure 4.2.9.2 Pop-up alert screen to request confirmation. Click on **Yes**. Then the switch will be rebooted immediately.

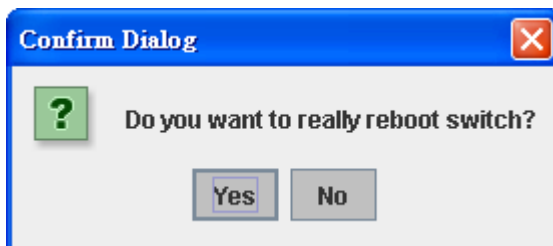
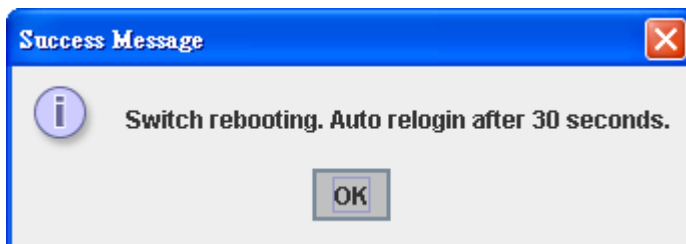

Figure 4.2.9.3 Pop-up message screen appears when rebooting the switch.



## 4.2.10 CLI Commands for Basic Setting

| Feature                                             | Command Line                                                                                                                                                                                                                                                                                                           |
|-----------------------------------------------------|------------------------------------------------------------------------------------------------------------------------------------------------------------------------------------------------------------------------------------------------------------------------------------------------------------------------|
| <b>Switch Setting</b>                               |                                                                                                                                                                                                                                                                                                                        |
| System Name                                         | Switch(config)# hostname<br>WORD Network name of this system<br>Switch(config)# hostname JN4508V2<br>SWITCH(config)#                                                                                                                                                                                                   |
| System Location                                     | SWITCH(config)# snmp-server location Taipei                                                                                                                                                                                                                                                                            |
| System Contact                                      | SWITCH(config)# snmp-server contact korecare@korenix.com                                                                                                                                                                                                                                                               |
| Display                                             | SWITCH# show snmp-server name<br>SWITCH#<br><br>SWITCH# show snmp-server location<br>Taipei<br><br>SWITCH# show snmp-server contact<br><a href="mailto:korecare@korenix.com">korecare@korenix.com</a><br><br>SWITCH> show version<br>0.31-20061218<br><br>Switch# show hardware mac<br>MAC Address : 00:12:77:FF:01:B0 |
| <b>Admin Password</b>                               |                                                                                                                                                                                                                                                                                                                        |
| User Name and Password                              | SWITCH(config)# administrator<br>NAME Administrator account name<br>SWITCH(config)# administrator orwell<br>PASSWORD Administrator account password<br>SWITCH(config)# administrator orwell orwell<br>Change administrator account orwell and password orwell<br>success.                                              |
| Display                                             | SWITCH# show administrator<br>Administrator account information<br>name: orwell<br>password: orwell                                                                                                                                                                                                                    |
| <b>IP Configuration</b>                             |                                                                                                                                                                                                                                                                                                                        |
| IP Address/Mask<br>(192.168.10.8,<br>255.255.255.0) | SWITCH(config)# int vlan 1<br>SWITCH(config-if)# ip<br>address<br>dhcp<br>SWITCH(config-if)# ip address 192.168.10.8/24<br>SWITCH(config-if)# ip dhcp client<br>SWITCH(config-if)# ip dhcp client renew                                                                                                                |
| Gateway                                             | SWITCH(config)# ip route 0.0.0.0/0 192.168.10.254/24                                                                                                                                                                                                                                                                   |
| Remove Gateway                                      | SWITCH(config)# no ip route 0.0.0.0/0 192.168.10.254/24                                                                                                                                                                                                                                                                |
| Display                                             | SWITCH# show running-config<br><br>.....<br>!<br>interface vlan1<br>ip address 192.168.10.8/24<br>no shutdown                                                                                                                                                                                                          |



|                           |                                                                                                                                                                                                                                                                                                                                                                    |
|---------------------------|--------------------------------------------------------------------------------------------------------------------------------------------------------------------------------------------------------------------------------------------------------------------------------------------------------------------------------------------------------------------|
|                           | !<br>ip route 0.0.0.0/0 192.168.10.254/24<br>!                                                                                                                                                                                                                                                                                                                     |
| <b>Time Setting</b>       |                                                                                                                                                                                                                                                                                                                                                                    |
| NTP Server                | SWITCH(config)# ntp peer<br>enable<br>disable<br>primary<br>secondary<br>SWITCH(config)# ntp peer primary<br>IPADDR<br>SWITCH(config)# ntp peer primary 192.168.10.120                                                                                                                                                                                             |
| Time Zone                 | SWITCH(config)# clock timezone 26<br>Sun Jan 1 04:13:24 2006 (GMT) Greenwich Mean Time:<br>Dublin, Edinburgh, Lisbon, London<br><br><b>Note:</b> By typing clock timezone ?, you can see the timezone list. Then choose the number of the timezone you want to select.                                                                                             |
| IEEE 1588 PTP             | Switch (config) # ptpd run → enable IEEE 1588 PTP with auto mode<br>PTPd is enabled!<br>Switch (config)# ptpd run preferred-clock → master mode<br>Switch (config)# ptpd run slave → slave mode<br>Switch (config)# no ptpd run → disable IEEE 1588 PTP<br>PTPd is disabled!                                                                                       |
| Display                   | SWITCH# sh ntp associations<br>Network time protocol<br>Status : Disabled<br>Primary peer : N/A<br>Secondary peer : N/A<br>SWITCH# show clock<br>Sun Jan 1 04:14:19 2006 (GMT) Greenwich Mean Time:<br>Dublin, Edinburgh, Lisbon, London<br><br>SWITCH# show clock timezone<br>clock timezone (26) (GMT) Greenwich Mean Time: Dublin,<br>Edinburgh, Lisbon, London |
| Daylight Saving           | Switch(config)# clock summer-time 4 0 2 12:00 4 0 3 12:00<br>Clock summer-time <start week of month > <start weekday><br><start month> <start Hour:Min> <end week of month> <end<br>weekday> <end month> <end Hour:Min>                                                                                                                                            |
| <b>DHCP Server</b>        |                                                                                                                                                                                                                                                                                                                                                                    |
| DHCP Server configuration | Enable DHCP Server on JetNet Switch<br>Switch#<br>Switch# configure terminal<br>Switch(config)# router dhcp<br>Switch(config-dhcp)# service dhcp<br><br>Configure DHCP network address pool<br>Switch(config-dhcp)#network 50.50.50.0/4 -( network/mask)<br>Switch(config-dhcp)#default-router 50.50.50.1                                                          |
| Lease time configure      | Switch(config-dhcp)#lease 300 (300 sec)                                                                                                                                                                                                                                                                                                                            |

|                                   |                                                                                                                                                                                                                                                                                                                                                                                                                                                                                                                                                                                                                                                      |
|-----------------------------------|------------------------------------------------------------------------------------------------------------------------------------------------------------------------------------------------------------------------------------------------------------------------------------------------------------------------------------------------------------------------------------------------------------------------------------------------------------------------------------------------------------------------------------------------------------------------------------------------------------------------------------------------------|
| DHCP Relay Agent                  | <p>Enable DHCP Relay Agent<br/>Switch#<br/>Switch# configure terminal<br/>Switch(config)# router dhcp<br/>Switch(config-dhcp)# service dhcp<br/>Switch(config-dhcp)# ip dhcp relay information option</p> <p>Enable DHCP Relay policy<br/>Switch(config-dhcp)# ip dhcp relay information policy <u>replace</u><br/>drop      Relay Policy<br/>keep      Drop/Keep/Replace option82 field<br/>replace</p>                                                                                                                                                                                                                                             |
| Show DHCP server information      | <p>Switch# show ip dhcp server statistics<br/>Switch# show ip dhcp server statistics<br/>DHCP Server ON<br/>Address Pool 1<br/>    network:192.168.17.0/24<br/>    default-router:192.168.17.254<br/>    lease time:300<br/>Excluded Address List<br/>    IP Address<br/>-----<br/>    (list excluded address)<br/>Manual Binding List<br/>    IP Address          MAC Address<br/>-----                -----<br/>    (list IP &amp; MAC binding entry)<br/>Leased Address List<br/>    IP Address          MAC Address          Leased Time Remains<br/>-----                -----<br/>    (list leased Time remain information for each entry)</p> |
| <b>Backup and Restore</b>         |                                                                                                                                                                                                                                                                                                                                                                                                                                                                                                                                                                                                                                                      |
| Backup Startup Configuration file | <p>Switch# copy startup-config tftp: 192.168.10.33/default.conf<br/>Writing Configuration [OK]</p> <p><b>Note 1:</b> To backup the latest startup configuration file, you should save current settings to flash first. You can refer to 4.12 to see how to save settings to the flash.<br/><b>Note 2:</b> 192.168.10.33 is the TFTP server's IP and default.conf is name of the configuration file. Your environment may use different IP addresses or different file name. Please type target TFTP server IP or file name in this command.</p>                                                                                                      |
| Restore Configuration             | Switch# copy tftp: 192.168.10.33/default.conf startup-config                                                                                                                                                                                                                                                                                                                                                                                                                                                                                                                                                                                         |
| Show Startup Configuration        | Switch# show startup-config                                                                                                                                                                                                                                                                                                                                                                                                                                                                                                                                                                                                                          |
| Show Running Configuration        | Switch# show running-config                                                                                                                                                                                                                                                                                                                                                                                                                                                                                                                                                                                                                          |
| <b>Firmware Upgrade</b>           |                                                                                                                                                                                                                                                                                                                                                                                                                                                                                                                                                                                                                                                      |
| Firmware Upgrade                  | <p>Switch# archive download-sw /overwrite tftp 192.168.10.33<br/>JN4508v2.bin<br/>Firmware upgrading, don't turn off the switch!<br/>Tftping file JN4508v2.bin<br/>Firmware upgrading<br/>.....<br/>.....<br/>.....</p>                                                                                                                                                                                                                                                                                                                                                                                                                              |

|                        |                                                                    |
|------------------------|--------------------------------------------------------------------|
|                        | Firmware upgrade success!!<br>Rebooting.....                       |
| <b>Factory Default</b> |                                                                    |
| Factory Default        | Switch# reload default-config file<br>Reload OK!<br>Switch# reboot |
| <b>System Reboot</b>   |                                                                    |
| Reboot                 | Switch# reboot                                                     |

### 4.3 Port Configuration

Port Configuration group enables you to enable/disable port state, or configure port auto-negotiation, speed, and duplex, flow control, rate limit control and port aggregation settings. It also allows you to view port status and aggregation information.

Following commands are included in this group:

4.3.1 Port Control

4.3.2 Port Status

4.3.3 Rate Control

4.3.4 Port Trunking

4.3.5 Command Lines for Port Configuration

#### 4.3.1 Port Control

Port Control commands allow you to enable/disable port state, or configure the port auto-negotiation, speed, duplex and flow control.

### Port Configuration

| Port | State  | Speed/Duplex     | Flow Control | Description     |
|------|--------|------------------|--------------|-----------------|
| 1    | Enable | Auto Negotiation | Symmetric    | Connect to ST-1 |
| 2    | Enable | 10 Full          | Disable      |                 |
| 3    | Enable | 10 Half          | Disable      |                 |
| 4    | Enable | 100 Full         | Disable      |                 |
| 5    | Enable | 100 Half         | Disable      |                 |
| 6    | Enable | Auto Negotiation | Disable      |                 |
| 7    | Enable | 100 Full         | Disable      |                 |
| 8    | Enable | 100 Full         | Disable      |                 |

Select the port you want to configure and make changes to the port.

In **State** column, you can enable or disable the state of this port. Once you disable, the port stop to link to the other end and stop to forward any traffic. The default setting is Enable which means all the ports are workable when you receive the device.



In **Speed/Duplex** column, you can configure port speed and duplex mode of this port. Below are the selections you can choose:

**JetNet 4508 (fa1~fa6)/ JetNet 4508f (fa1~fa6):** Auto Negotiation, 10Half (10Mbps Half Duplex mode), 10 Full (10Mbps, Full Duplex mode), 100 Half (100Mbps, Half Duplex), 100 Full (100Mbps, Full Duplex mode)

**JetNet 4508 (fa7, fa8):** 100Mbps Auto Negotiation, 100 Full (100Mbps, Full Duplex mode), 100 Half (100Mbps, Half Duplex)

**JetNet 4508f (fa7, fa8):** Fiber port, 100Full (100Mbps, Full Duplex) only.

In **Flow Control** column, "Symmetric" means that you need to activate the flow control function of the remote network device in order to let the flow control of that corresponding port on the switch to work. "Disable" means that you don't need to activate the flow control function of the remote network device, as the flow control of that corresponding port on the switch will work anyway.

Once you finish configuring the settings, click on **Apply** to save the configuration.

**Technical Tips:** *If both ends are not at the same speed, they can't link with each other. If both ends are not in the same duplex mode, they will be connected by half mode.*

### 4.3.2 Port Status

The Port Status shows the current port you current port status. It includes connection type, port link status, exactly operating speed and duplex mode and the flow control setting.

| Port Status |            |      |        |              |              |
|-------------|------------|------|--------|--------------|--------------|
| Port        | Type       | Link | State  | Speed/Duplex | Flow Control |
| 1           | 100BASE-TX | Up   | Enable | 100 Full     | Disable      |
| 2           | 100BASE    | Down | Enable | –            | Disable      |
| 3           | 100BASE    | Down | Enable | –            | Disable      |
| 4           | 100BASE    | Down | Enable | –            | Disable      |
| 5           | 100BASE-TX | Up   | Enable | 100 Full     | Disable      |
| 6           | 100BASE-TX | Up   | Enable | 100 Full     | Disable      |
| 7           | 100BASE-FX | Down | Enable | 100 Full     | Disable      |
| 8           | 100BASE-FX | Down | Enable | 100 Full     | Disable      |

The description of the columns is as below:

**Port:** Port interface number.

**Type:** 100TX -> Fast Ethernet port.

**Link:** Link status. Up -> Link UP. Down -> Link Down.

**State:** Enable -> State is enabled. Disable -> The port is disable/shutdown.

**Speed/Duplex:** Current working status of the port.

**Flow Control:** The state of the flow control.

### 4.3.3 Rate Control

The Rate Control feature allows user to limit the each port's data rate; the limitation mechanism is based on specified packet type. With the Ingress / Egress rate control feature, the network performance can be improved.

## Rate Control

Limit Packet Type and Rate

| Port | Ingress Packet Type              | Ingress Rate(Mbps) | Egress Packet Type | Egress Rate(Mbps) |
|------|----------------------------------|--------------------|--------------------|-------------------|
| 1    | Broadcast Only                   | 8                  | All                | 0                 |
| 2    | Broadcast Only                   | 8                  | All                | 0                 |
| 3    | BroadcastMulticast               | 8                  | All                | 0                 |
| 4    | BroadcastMulticastUnknownUnicast | 8                  | All                | 0                 |
| 5    | All                              | 8                  | All                | 0                 |
| 6    | Broadcast Only                   | 8                  | All                | 0                 |
| 7    | Broadcast Only                   | 8                  | All                | 0                 |
| 8    | Broadcast Only                   | 8                  | All                | 0                 |

Rate Control is a form of flow control used to enforce a strict bandwidth limit at a port. You can program separate transmit (Egress Rule) and receive (Ingress Rule) rate limits at each port, and even apply the limit to certain packet types as described below.

**Packet type:** You can select the packet type that you want to filter. The packet types of the Ingress Rule listed here include **Broadcast Only** / **Broadcast and multicast** / **Broadcast, Multicast and Unknown Unicast** or **All**. The packet types of the Egress Rule (outgoing) only support **all** packet types.

**Rate:** This column allows you to manually assign the limit rate of the port. Valid values are from 1Mbps-100Mbps for fast Ethernet ports. The step of the rate is 1 Mbps. Default value of Ingress Rule is "8" Mbps; default value of Egress Rule is 0 Mbps. 0 stands for disabling the rate control for the port.

Click on **Apply** to apply the configuration.

## 4.3.4 Port Trunking

Port Trunking configuration allows you to group multiple Ethernet ports in parallel to increase link bandwidth. The aggregated ports can be viewed as one physical port so that the bandwidth is higher than merely one single Ethernet port. The member ports of the same trunk group can balance the loading and backup for each other. Port Trunking feature is usually used when you need higher bandwidth for backbone network. This is an inexpensive way for you to transfer more data.

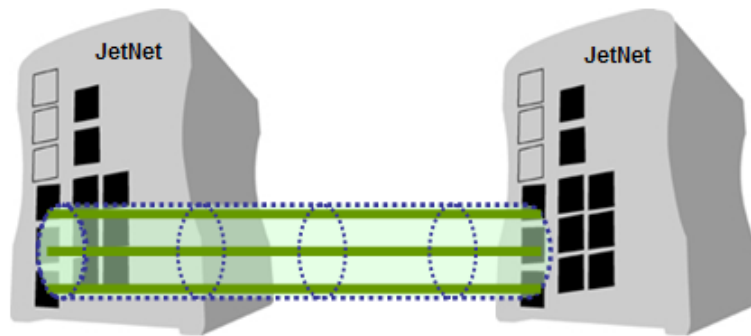

There are some different descriptions for the port trunking. Different manufacturers may use different descriptions for their products, like Link Aggregation Group (LAG), Link Aggregation Control Protocol, Ethernet Trunk, Ether Channel...etc. Most of the implementations now conform to IEEE standard, 802.3ad.

The aggregated ports can interconnect to the other switch which also supports Port Trunking. Korenix Supports 2 types of port trunking. One is Static Trunk, the other is 802.3ad. When the other end uses 802.3ad LACP, you **should** assign 802.3ad LACP to the trunk. When the other end uses non-802.3ad, you can then use Static Trunk.

There are 2 configuration pages, Aggregation Setting and Aggregation Status.



## Aggregation Setting

### Port Trunk - Aggregation Setting

| Port | Group ID | Trunk Type   |
|------|----------|--------------|
| 1    | Trunk 8  | 802.3ad LACP |
| 2    | Trunk 8  | 802.3ad LACP |
| 3    | Trunk 1  | Static       |
| 4    | Trunk 1  | Static       |
| 5    | None     | Static       |
| 6    | None     | Static       |
| 7    | None     | Static       |
| 8    | None     | Static       |

Note: The port parameters of the trunk members should be the same.

**Trunk Size:** The switch can support up to 4 trunk groups and maximum trunk member up to 8 ports.

**Group ID:** Group ID is the ID for the port trunking group. Ports with same group ID are in the same group.

**Trunk Type:** **Static** and **802.3ad LACP**. Each Trunk Group can only support Static or 802.3ad LACP. Choose the type you need here.

### Aggregation Status

This page shows the status of port aggregation. Once the aggregation ports are negotiated well, you will see following status.

**Port Trunk - Aggregation Information**

| Group ID | Type   | Aggregated Ports | Individual Ports | Link Down Ports |
|----------|--------|------------------|------------------|-----------------|
| Trunk 1  | Static |                  |                  | 3,4             |
| Trunk 2  |        |                  |                  |                 |
| Trunk 3  |        |                  |                  |                 |
| Trunk 4  |        |                  |                  |                 |
| Trunk 5  |        |                  |                  |                 |
| Trunk 6  |        |                  |                  |                 |
| Trunk 7  |        |                  |                  |                 |
| Trunk 8  | LACP   |                  |                  | 1,2             |

**Group ID:** Display Trunk 1 to Trunk 8 set up in Aggregation Setting.

**Type:** Static or LACP set up in Aggregation Setting. **(The JetNet 4508 V2 series only support 4 trunk groups.)**

**Aggregated Ports:** When LACP links well, you can see the member ports in aggregated column.

**Individual Ports:** When LACP is enabled, member ports of LACP group which are not connected to correct LACP member ports will be displayed in the Individual column.

**Link Down ports:** When LACP is enabled, member ports of LACP group which are not linked up will be displayed in the Link Down column.

### 4.3.5 Command Lines for Port Configuration

| Feature                           | Command Line                                                                                                                                                                                                                                                                                                                                                                                                                                                                                                 |
|-----------------------------------|--------------------------------------------------------------------------------------------------------------------------------------------------------------------------------------------------------------------------------------------------------------------------------------------------------------------------------------------------------------------------------------------------------------------------------------------------------------------------------------------------------------|
| <b>Port Control</b>               |                                                                                                                                                                                                                                                                                                                                                                                                                                                                                                              |
| Port Control – State              | <p>Switch(config-if)# shutdown -&gt; Disable port state<br/>Port1 Link Change to DOWN<br/>interface fastethernet1 is shutdown now.</p> <p>Switch(config-if)# no shutdown -&gt; Enable port state<br/>Port1 Link Change to DOWN<br/>Port1 Link Change to UP<br/>interface fastethernet1 is up now.<br/>Switch(config-if)# Port1 Link Change to UP</p>                                                                                                                                                         |
| Port Control – Auto Negotiation   | <p>Switch(config)# interface fa1<br/>Switch(config-if)# auto-negotiation<br/>Auto-negotiation of port 1 is enabled!</p>                                                                                                                                                                                                                                                                                                                                                                                      |
| Port Control – Force Speed/Duplex | <p>Switch(config-if)# speed 100<br/>Port1 Link Change to DOWN<br/>set the speed mode ok!<br/>Switch(config-if)# Port1 Link Change to UP</p> <p>Switch(config-if)# duplex full<br/>Port1 Link Change to DOWN<br/>set the duplex mode ok!<br/>Switch(config-if)# Port1 Link Change to UP</p>                                                                                                                                                                                                                   |
| Port Control – Flow Control       | <p>Switch(config-if)# flowcontrol on<br/>Flowcontrol on for port 1 set ok!</p> <p>Switch(config-if)# flowcontrol off<br/>Flowcontrol off for port 1 set ok!</p>                                                                                                                                                                                                                                                                                                                                              |
| <b>Port Status</b>                |                                                                                                                                                                                                                                                                                                                                                                                                                                                                                                              |
| Port Status                       | <p>Switch# show interface fa1<br/>Interface fastethernet1<br/>Administrative Status : Enable<br/>Operating Status : Connected<br/>Duplex : Full<br/>Speed : 100<br/>Flow Control :off<br/>Default Port VLAN ID: 1<br/>Ingress Filtering : Disabled<br/>Acceptable Frame Type : All<br/>Port Security : Disabled<br/>Auto Negotiation : Disable<br/>Loopback Mode : None<br/>STP Status: forwarding<br/>Default CoS Value for untagged packets is 0.<br/>Mdix mode is Disable.<br/>Medium mode is Copper.</p> |

|                                   | <p><i>Note: Administrative Status -&gt; Port state of the port. Operating status -&gt; Current status of the port. Duplex -&gt; Duplex mode of the port. Speed -&gt; Speed mode of the port. Flow control -&gt; Flow Control status of the port.</i></p>                                                                                                                                                                                                                                                                                                                                                            |                |          |       |      |      |                |     |     |       |   |   |   |   |      |   |   |   |   |      |   |   |   |   |      |
|-----------------------------------|---------------------------------------------------------------------------------------------------------------------------------------------------------------------------------------------------------------------------------------------------------------------------------------------------------------------------------------------------------------------------------------------------------------------------------------------------------------------------------------------------------------------------------------------------------------------------------------------------------------------|----------------|----------|-------|------|------|----------------|-----|-----|-------|---|---|---|---|------|---|---|---|---|------|---|---|---|---|------|
| <p><b>Rate Control</b></p>        |                                                                                                                                                                                                                                                                                                                                                                                                                                                                                                                                                                                                                     |                |          |       |      |      |                |     |     |       |   |   |   |   |      |   |   |   |   |      |   |   |   |   |      |
| Rate Control – Ingress or Egress  | <pre>Switch(config-if)# rate-limit   egress   Outgoing packets   ingress  Incoming packets</pre> <p><b>Note: To enable rate control, you should select the Ingress or Egress rule first; then assign the packet type and bandwidth.</b></p>                                                                                                                                                                                                                                                                                                                                                                         |                |          |       |      |      |                |     |     |       |   |   |   |   |      |   |   |   |   |      |   |   |   |   |      |
| Rate Control – Filter Packet Type | <pre>Switch(config-if)# rate-limit ingress mode   all           Limit all frames   broadcast     Limit Broadcast frames   flooded-unicast Limit Broadcast, Multicast and flooded unicast frames   multicast     Limit Broadcast and Multicast frames</pre> <pre>Switch(config-if)# rate-limit ingress mode broadcast</pre> <p>Set the ingress limit mode broadcast ok.</p>                                                                                                                                                                                                                                          |                |          |       |      |      |                |     |     |       |   |   |   |   |      |   |   |   |   |      |   |   |   |   |      |
| Rate Control - Bandwidth          | <pre>Switch(config-if)# rate-limit ingress bandwidth   &lt;0-100&gt;    Limit in magabits per second (0 is no limit)</pre> <pre>Switch(config-if)# rate-limit ingress bandwidth 8</pre> <p>Set the ingress rate limit 8Mbps for Port 1.</p>                                                                                                                                                                                                                                                                                                                                                                         |                |          |       |      |      |                |     |     |       |   |   |   |   |      |   |   |   |   |      |   |   |   |   |      |
| <p><b>Port Trunking</b></p>       |                                                                                                                                                                                                                                                                                                                                                                                                                                                                                                                                                                                                                     |                |          |       |      |      |                |     |     |       |   |   |   |   |      |   |   |   |   |      |   |   |   |   |      |
| LACP                              | <pre>Switch(config)# lACP group 1 fa6-8</pre> <p>Group 1 based on LACP(802.3ad) is enabled!</p> <p><i>Note: The interface list is fa1-8</i></p> <p>Note: different speed port can't be aggregated together.</p>                                                                                                                                                                                                                                                                                                                                                                                                     |                |          |       |      |      |                |     |     |       |   |   |   |   |      |   |   |   |   |      |   |   |   |   |      |
| Static Trunk                      | <pre>Switch(config)# trunk group 2 fa4-5</pre> <p>Trunk group 2 enable ok!</p>                                                                                                                                                                                                                                                                                                                                                                                                                                                                                                                                      |                |          |       |      |      |                |     |     |       |   |   |   |   |      |   |   |   |   |      |   |   |   |   |      |
| Display - LACP                    | <pre>Switch# show lACP internal</pre> <p>LACP group 1 internal information:</p> <table border="1"> <thead> <tr> <th>LACP Port</th> <th>Admin</th> <th>Oper</th> <th>Port</th> </tr> <tr> <th>Port</th> <th>Priority</th> <th>Key</th> <th>Key</th> <th>State</th> </tr> </thead> <tbody> <tr> <td>6</td> <td>1</td> <td>6</td> <td>6</td> <td>0x45</td> </tr> <tr> <td>7</td> <td>1</td> <td>7</td> <td>7</td> <td>0x45</td> </tr> <tr> <td>8</td> <td>1</td> <td>8</td> <td>8</td> <td>0x45</td> </tr> </tbody> </table> <p>LACP group 2 is inactive<br/>LACP group 3 is inactive<br/>LACP group 4 is inactive</p> | LACP Port      | Admin    | Oper  | Port | Port | Priority       | Key | Key | State | 6 | 1 | 6 | 6 | 0x45 | 7 | 1 | 7 | 7 | 0x45 | 8 | 1 | 8 | 8 | 0x45 |
| LACP Port                         | Admin                                                                                                                                                                                                                                                                                                                                                                                                                                                                                                                                                                                                               | Oper           | Port     |       |      |      |                |     |     |       |   |   |   |   |      |   |   |   |   |      |   |   |   |   |      |
| Port                              | Priority                                                                                                                                                                                                                                                                                                                                                                                                                                                                                                                                                                                                            | Key            | Key      | State |      |      |                |     |     |       |   |   |   |   |      |   |   |   |   |      |   |   |   |   |      |
| 6                                 | 1                                                                                                                                                                                                                                                                                                                                                                                                                                                                                                                                                                                                                   | 6              | 6        | 0x45  |      |      |                |     |     |       |   |   |   |   |      |   |   |   |   |      |   |   |   |   |      |
| 7                                 | 1                                                                                                                                                                                                                                                                                                                                                                                                                                                                                                                                                                                                                   | 7              | 7        | 0x45  |      |      |                |     |     |       |   |   |   |   |      |   |   |   |   |      |   |   |   |   |      |
| 8                                 | 1                                                                                                                                                                                                                                                                                                                                                                                                                                                                                                                                                                                                                   | 8              | 8        | 0x45  |      |      |                |     |     |       |   |   |   |   |      |   |   |   |   |      |   |   |   |   |      |
| Display - Trunk                   | <pre>Switch# show trunk group 1</pre> <p>FLAGS: I -&gt; Individual P -&gt; In channel<br/>D -&gt; Port Down</p> <pre>Trunk Group GroupID Protocol Ports</pre> <table border="1"> <thead> <tr> <th>GroupID</th> <th>Protocol</th> <th>Ports</th> </tr> </thead> <tbody> <tr> <td>1</td> <td>LACP</td> <td>6(D) 7(D) 8(D)</td> </tr> </tbody> </table> <pre>Switch# show trunk group 2</pre> <p>FLAGS: I -&gt; Individual P -&gt; In channel<br/>D -&gt; Port Down</p>                                                                                                                                                | GroupID        | Protocol | Ports | 1    | LACP | 6(D) 7(D) 8(D) |     |     |       |   |   |   |   |      |   |   |   |   |      |   |   |   |   |      |
| GroupID                           | Protocol                                                                                                                                                                                                                                                                                                                                                                                                                                                                                                                                                                                                            | Ports          |          |       |      |      |                |     |     |       |   |   |   |   |      |   |   |   |   |      |   |   |   |   |      |
| 1                                 | LACP                                                                                                                                                                                                                                                                                                                                                                                                                                                                                                                                                                                                                | 6(D) 7(D) 8(D) |          |       |      |      |                |     |     |       |   |   |   |   |      |   |   |   |   |      |   |   |   |   |      |

| Trunk Group |          |           |
|-------------|----------|-----------|
| GroupID     | Protocol | Ports     |
| 2           | Static   | 4(D) 5(P) |

Switch#

## 4.4 Network Redundancy

It is critical for industrial applications that network remains non-stop. JetNet Switch firmware supports standard RSTP, Multiple Super Ring, Rapid Dual Homing and backward compatible with Legacy Super Ring Client modes.

Multiple Super Ring (**MSR™**) technology is **Korenix's** 3<sup>rd</sup> generation Ring redundancy technology. This is patented and protected by **Korenix** and is used in countries all over the world. MSR ranks the fastest restore and failover time in the world, 0 ms for restore and about 5 milliseconds for failover for copper.

Advanced Rapid Dual Homing (**RDH™**) technology also facilitates *JetNet managed Switch* to connect with a core managed switch easily and conveniently. With **RDH™** technology, you can also couple several Rapid Super Rings or RSTP cloud together, which is also known as Auto Ring Coupling.

To become backwards compatible with the Legacy Super Ring technology implemented in the *JetNet* series, *the JetNet 4508 series* also supports Super Ring Client mode. The Super Ring ports can pass through Super Ring control packets extremely well and works with Super Ring.

Besides Korenix ring technology, *JetNet Switch* also supports 802.1D-2004 version Rapid Spanning Tree Protocol (RSTP). New version of RSTP standard includes 802.1D-1998 STP, 802.1w RSTP, IEEE 802.1s MSTP (Multiple Spanning Tree). The MSTP function is available from 1.1 version firmwear, if your device does not support it, please download the new firmware from Korenix Web site.

Following commands are included in this group:

4.4.1 STP Configuration

4.4.2 Port Configuration

4.4.3 STP Information

4.4.4 MSTP Configuration

4.4.5 MSTP Port Configuration

4.4.6 MSTP Information

4.4.7 Multiple Super Ring

4.4.8 Multiple Super Ring Information

4.4.9 Command lines for network redundancy

### 4.4.1 STP Configuration

This page allows select the STP mode and configuring the global STP/RSTP Bridge Configuraiton.

The STP mode includes the **STP**, **RSTP**, **MSTP** and **Disable**. Please select

the STP mode for your system first. The default mode is RSTP enabled.

After select the STP or RSTP mode; continue to configure the global Bridge parameters for STP and RSTP.

After select the MSTP mode, please go to MSTP Configuration page.

## STP Configuration

**STP Mode**

**Bridge Configuration**

|                 |                                   |
|-----------------|-----------------------------------|
| Bridge Address  | <input type="text" value="1212"/> |
| Bridge Priority | <input type="text" value=""/>     |
| Max Age         | <input type="text" value="20"/>   |
| Hello Time      | <input type="text" value="2"/>    |
| Forward Delay   | <input type="text" value="16"/>   |

### RSTP (Refer to the 4.4.1 of previous version manual.)

RSTP is the abbreviation of Rapid Spanning Tree Protocol. If a switch has more than one path to a destination, it will lead to message loops that can generate broadcast storms and quickly bog down a network. The spanning tree was created to combat the negative effects of message loops in switched networks. A spanning tree uses a spanning tree algorithm (STA) to automatically sense whether a switch has more than one way to communicate with a node. It will then select the best path (primary), and block the other path(s). It will also keep track of the blocked path(s) in case the primary path fails. Spanning Tree Protocol (STP) introduced a standard method to accomplish this. It is specified in IEEE 802.1D-1998. Later, Rapid Spanning Tree Protocol (RSTP) was adopted and represents the evolution of STP, providing much faster spanning tree convergence after a topology change. This is specified in IEEE 802.1w. In 2004, 802.1w is included into 802.1D-2004 version. This switch supports both RSTP and STP (all switches that support RSTP are also backward compatible with switches that support only STP).

### Bridge Configuration

**Bridge Address:** This shows the switch's MAC address.

**Priority (0-61440):** RSTP uses bridge ID to determine the root bridge, the bridge with the highest bridge ID becomes the root bridge. The bridge ID is composed of bridge priority and bridge MAC address. So that the bridge with the highest priority becomes the highest bridge ID. If all the bridge ID



has the same priority, the bridge with the lowest MAC address will then become the root bridge.

Note: The bridge priority value must be in multiples of 4096. A device with a lower number has a higher bridge priority. Ex: 4096 is higher than 32768.

Note: The Web GUI allows user select the priority number directly. This is the convenient of the GUI design. When you configure the value through the CLI or SNMP, you may need to type the value directly. Please follow the  $n \times 4096$  rules for the Bridge Priority.

**Max Age (6-40):** Enter a value from 6 to 40 seconds here. This value represents the time that a bridge will wait without receiving Spanning Tree Protocol configuration messages before attempting to reconfigure.

If JetNet is not the root bridge, and if it has not received a hello message from the root bridge in an amount of time equal to Max Age, then JetNet will reconfigure itself as a root bridge. Once two or more devices on the network are recognized as a root bridge, the devices will renegotiate to set up a new spanning tree topology.

**Hello Time (1-10):** Enter a value from 1 to 10 seconds here. This is a periodic timer that drives the switch to send out BPDU (Bridge Protocol Data Unit) packet to check current STP status.

The root bridge of the spanning tree topology periodically sends out a “hello” message to other devices on the network to check if the topology is “healthy”. The “hello time” is the amount of time the root has waited during sending hello messages.

**Forward Delay Time (4-30):** Enter a value between 4 and 30 seconds. This value is the time that a port waits before changing from Spanning Tree Protocol learning and listening states to forwarding state.

This is the amount of time JetNet will wait before checking to see if it should be changed to a different state.

Once you have completed your configuration, click on **Apply** to apply your settings.

**Note:** You must observe the following rule to configure Hello Time, Forwarding Delay, and Max Age parameters.

**$2 \times (\text{Forward Delay Time} - 1 \text{ sec}) \geq \text{Max Age Time} \geq 2 \times (\text{Hello Time value} + 1 \text{ sec})$**

#### 4.4.2 STP Port Configuration

This page allows you to configure the port parameter after enabled STP or RSTP.

##### Port Configuration

Select the port you want to configure and you will be able to view current setting and status of the port.



### STP Port Configuration

| Port | Path Cost | Priority | Link Type | Edge Port |
|------|-----------|----------|-----------|-----------|
| 1    | 20000     | 128      | Auto      | Enable    |
| 2    | 20000     | 128      | Auto      | Enable    |
| 3    | 20000     | 128      | Auto      | Enable    |
| 4    | 20000     | 128      | Auto      | Enable    |
| 5    | 20000     | 128      | Auto      | Enable    |
| 6    | 20000     | 128      | Auto      | Enable    |
| 7    | 20000     | 128      | Auto      | Enable    |
| 8    | 20000     | 128      | Auto      | Enable    |
| 9    | 20000     | 128      | Auto      | Enable    |

**Path Cost:** Enter a number between 1 and 200,000,000. This value represents the “cost” of the path to the other bridge from the transmitting bridge at the specified port.

**Priority:** Enter a value between 0 and 240, using multiples of 16. This is the value that decides which port should be blocked by priority in a LAN.

**Link Type:** There are 3 types for you select. **Auto**, **P2P** and **Share**.

Some of the rapid state transitions that are possible within RSTP depend upon whether the port of concern can only be connected to another bridge (i.e. it is served by a point-to-point LAN segment), or if it can be connected to two or more bridges (i.e. it is served by a shared-medium LAN segment). This function allows link status of the link to be manipulated administratively. “**Auto**” means to auto select P2P or Share mode. “**P2P**” means P2P is enabled, the 2 ends work in Full duplex mode. While “**Share**” is enabled, it means P2P is disabled, the 2 ends may connect through a share media and work in Half duplex mode.

**Edge:** A port directly connected to the end stations cannot create a bridging loop in the network. To configure this port as an edge port, set the port to the **Enable** state. When the non-bridge device connects an admin edge port, this port will be in blocking state and turn to forwarding state in 4 seconds.

Once you finish your configuration, click on **Apply** to save your settings.

#### 4.4.3 RSTP Info

This page allows you to see the information of the root switch and port status.

### RSTP Information

#### Root Information

|                     |                     |
|---------------------|---------------------|
| Bridge ID           | 8000.0012.7760.1455 |
| Root Priority       | 32768               |
| Root Port           | N/A                 |
| Root Path Cost      | 0                   |
| Max Age(6-40)       | 20 sec              |
| Hello Time(1-10)    | 2 sec               |
| Forward Delay(4-30) | 15 sec              |

#### Port Information

| Port | Role       | Port State | Path Cost | Port Priority | Oper P2P | Oper Edge |
|------|------------|------------|-----------|---------------|----------|-----------|
| 1    | --         | Disabled   | 200000    | 128           | P2P      | Edge      |
| 2    | --         | Disabled   | 200000    | 128           | Shared   | Edge      |
| 3    | Designated | Forwarding | 200000    | 128           | P2P      | Non-Edge  |
| 4    | --         | Disabled   | 200000    | 128           | Shared   | Edge      |
| 5    | --         | Disabled   | 200000    | 128           | Shared   | Edge      |
| 6    | --         | Disabled   | 200000    | 128           | Shared   | Edge      |
| 7    | --         | Disabled   | 200000    | 128           | Shared   | Edge      |
| 8    | --         | Disabled   | 200000    | 128           | P2P      | Edge      |
| 9    | Designated | Forwarding | 200000    | 128           | P2P      | Edge      |
| 10   | Designated | Forwarding | 200000    | 128           | P2P      | Edge      |

Reload

**Root Information:** You can see root Bridge ID, Root Priority, Root Port, Root Path Cost and the Max Age, Hello Time and Forward Delay of BPDU sent from the root switch.

**Port Information:** You can see port Role, Port State, Path Cost, Port Priority, Oper P2P mode, Oper edge port mode and Aggregated (ID/Type).

#### 4.4.4 MSTP (Multiple Spanning Tree Protocol) Configuration

MSTP is the abbreviation of Multiple Spanning Tree Protocol. This protocol is a direct extension of RSTP. It can provide an independent spanning tree for different VLANs. It simplifies network management, provides for even faster convergence than RSTP by limiting the size of each region, and prevents VLAN members from being segmented from the rest of the group (as sometimes occurs with IEEE 802.1D STP).

While using MSTP, there are some new concepts of network architecture. A switch may belong to different group, acts as root or designate switch, generate BPDU for the network to maintain the forwarding table of the spanning tree. With MSTP, it can also provide multiple forwarding paths and enable load balancing. Understand the architecture allows you to maintain the correct spanning tree and operate effectively.

One VLAN can be mapped to a Multiple Spanning Tree Instance (MSTI). The maximum Instance of JetNet 4508 supports is 16, range from 0-15. The MSTP builds a separate Multiple Spanning Tree (MST) for each instance to maintain connectivity among each of the assigned VLAN groups. An Internal Spanning Tree (IST) is used to connect all the MSTP switches within an MST region. An MST Region may contain multiple MSTP Instances.

The figure shows there are 2 VLANs/MSTP Instances and each instance has its Root and forwarding paths.

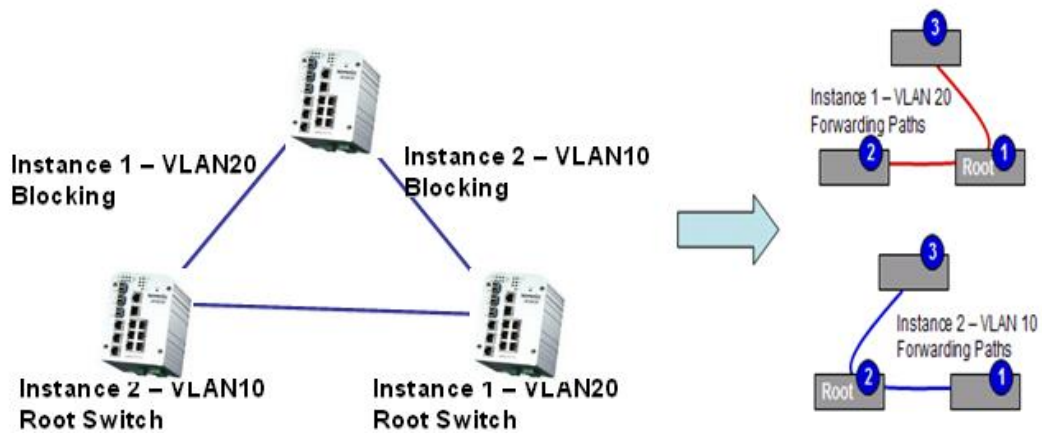

A Common Spanning Tree (CST) interconnects all adjacent MST regions and acts as a virtual bridge node for communications with STP or RSTP nodes in the global network. MSTP connects all bridges and LAN segments with a single Common and Internal Spanning Tree (CIST). The CIST is formed as a result of the running spanning tree algorithm between switches that support the STP, RSTP, MSTP protocols.

The figure shows the CST large network. In this network, a Region may have different instances and its own forwarding path and table; however, it

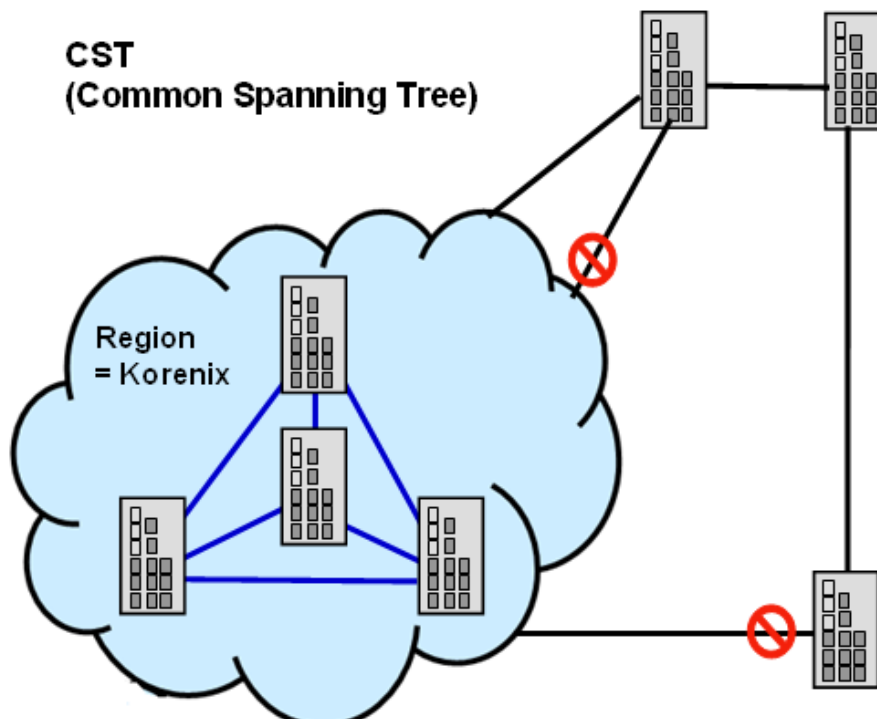

To configure the MSTP setting, the STP Mode of the STP Configuration page should be changed to MSTP mode first.

## STP Configuration

STP Mode

### Bridge Configuration

|                 |                |
|-----------------|----------------|
| Bridge Address  | 0012.7760.46b6 |
| Bridge Priority | 32768 ▼        |
| Max Age         | 20 ▼           |
| Hello Time      | 2 ▼            |
| Forward Delay   | 15 ▼           |

After enabled MSTP mode, then you can go to the MSTP Configuraiton pages.

## MSTP Region Configuration

This page allows configure the Region Name and its Revision, mapping the VLAN to Instance and check current MST Instance configuration. The network can be divided virtually to different Regions. The switches within the Region should have the same Region and Revision leve.

**Region Name:** The name for the Region. Maximum length: 32 characters.

**Revision:** The revision for the Region. Range: 0-65535; Default: 0)

Once you finish your configuration, click on **Apply** to apply your settings.

## New MST Instance

This page allows mapping the VLAN to Instance and assign priority to the instance. Before mapping VLAN to Instance, you should create VLAN and assign the member ports first. Please refer to the VLAN setting page.

# korenix

## MSTP Configuration

### MST Region Configuration

|             |         |
|-------------|---------|
| Region Name | Korenix |
| Revision    | 0       |

Apply

### New MST Instance

|                   |       |
|-------------------|-------|
| Instance ID       | 1     |
| VLAN Group        |       |
| Instance Priority | 32768 |

Add

**Instance ID:** Select the Instance ID, the available number is 1-15.  
**VLAN Group:** Type the VLAN ID you want mapping to the instance.  
**Instance Priority:** Assign the priority to the instance.  
**After** finish your configuration, click on **Add** to apply your settings.

### Current MST Instance Configuration

This page allows you to see the current MST Instance Configuration you added. Click on “**Apply**” to apply the setting. You can “**Remove**” the instance or “**Reload**” the configuration display in this page.

### Current MST Instance Configuration

| Instance ID | VLAN Group | Instance Priority |
|-------------|------------|-------------------|
| 1           | 2          | 32768             |
| 2           | 3          | 32768             |

Apply

Remove

Reload

#### 4.4.5 MSTP Port Configuration

This page allows configure the Port settings. Choose the Instance ID you want to configure. The MSTP enabled and linked up ports within the instance will be listed in this table.

Note that the ports not belonged to the Instance, or the ports not MSTP activated will not display. The meaning of the Path Cost, Priority, Link Type and Edge Port is the same as the definition of RSTP.

## MSTP Port Configuration

Instance ID

| Port | Path Cost | Priority | Link Type | Edge Port |
|------|-----------|----------|-----------|-----------|
| 1    | 200000    | 128      | Auto      | Enable    |
| 2    | 200000    | 128      | Auto      | Enable    |

**Path Cost:** Enter a number between 1 and 200,000,000. This value represents the “cost” of the path to the other bridge from the transmitting bridge at the specified port.

**Priority:** Enter a value between 0 and 240, using multiples of 16. This is the value that decides which port should be blocked by priority in a LAN.

**Link Type:** There are 3 types for you select. **Auto**, **P2P** and **Share**.

Some of the rapid state transitions that are possible within RSTP depend upon whether the port of concern can only be connected to another bridge (i.e. it is served by a point-to-point LAN segment), or if it can be connected to two or more bridges (i.e. it is served by a shared-medium LAN segment). This function allows link status of the link to be manipulated administratively. “**Auto**” means to auto select P2P or Share mode. “**P2P**” means P2P is enabled; the 2 ends work in full duplex mode. While “**Share**” is enabled, it means P2P is disabled; the 2 ends may connect through a share media and work in half duplex mode.

**Edge:** A port directly connected to the end stations cannot create a bridging loop in the network. To configure this port as an edge port, set the port to the **Enable** state. When the non-bridge device connects an admin edge port, this port will be in blocking state and turn to forwarding state in 4 seconds.

Once you finish your configuration, click on **Apply** to save your settings.

### 4.4.6 MSTP Information

This page allows you to see the current MSTP information.



Choose the **Instance ID** first. If the instance is not added, the information remains blank.

The **Root Information** shows the setting of the Root switch.

The **Port Information** shows the port setting and status of the ports within the instance.

### MSTP Information

Instance ID

#### Root Information

|                |                |
|----------------|----------------|
| Root Address   | 0012.7760.ad4b |
| Root Priority  | 4096           |
| Root Port      | N/A            |
| Root Path Cost | 0              |
| Max Age        | 20 second(s)   |
| Hello Time     | 2 second(s)    |
| Forward Delay  | 15 second(s)   |

#### Port Information

| Port | Role       | Port State | Path Cost | Port Priority | Link Type          | Edge Port |
|------|------------|------------|-----------|---------------|--------------------|-----------|
| 5    | Designated | Forwarding | 200000    | 128           | P2P Internal(MSTP) | Non-Edge  |
| 6    | Designated | Forwarding | 200000    | 128           | P2P Internal(MSTP) | Non-Edge  |

Click "**Reload**" to reload the MSTP information display.

## 4.4.7 Multiple Super Ring (MSR) (The same as 4.4.31 of previous version manual.)

The most common industrial network redundancy is to form a ring or loop. Typically, the managed switches are connected in series and the last switch is connected back to the first one. In such connection, you can implement Korenix Multiple Super Ring technology to get fastest recovery performance.

**Multiple Super Ring (MSR)** technology is *Korenix's* 3<sup>rd</sup> generation Ring redundancy technology. This is patented and protected by *Korenix* and is used in countries all over the world. MSR ranks the fastest restore and failover time in the world, 0 ms for restore and about milliseconds level for failover for 100Base-TX copper port. The other interface may take longer time due to the media characteristics.

Advanced **Rapid Dual Homing (RDH)** technology also facilitates *JetNet Managed Switch* to connect with a core managed switch easily and conveniently. With RDH technology, you can also couple several Rapid Super Rings or RSTP cloud together, which is also known as Auto Ring Coupling.

**TrunkRing** technology allows integrate MSR with LACP/Port Trunking. The LACP/Trunk aggregated ports is a virtual interface and it can work as the Ring port of the MSR.

**MultiRing** is an outstanding technology Korenix can support. Multiple rings can be aggregated within one switch by using different Ring ID. The maximum Ring number one switch can support is half of total port volume. For example, the JetNet 4508 series are 8-port Fast Ethernet Switch design, which means maximum supports 4 Rings (4 100Mbps Rings) can be aggregated in one JetNet 4508 Switch. The feature saves much effort when constructing complex network architecture.

**New Ring:** To create a Rapid Super Ring. Just fill in the Ring ID which has range from 0 to 31. If the name field is left blank, the name of this ring will be automatically naming with Ring ID.

### New Ring

| Ring ID | Name |
|---------|------|
| 1       |      |

Add



## Ring Configuration

| ID | Name  | Version       | Device Priority | Ring Port1 | Path Cost | Ring Port2 | Path Cost | Dual Homing II | Ring Status |
|----|-------|---------------|-----------------|------------|-----------|------------|-----------|----------------|-------------|
| 1  | Ring1 | Rapid Super R | 128             | Port 1     | 128       | Port 2     | 128       | Disable        | Enable      |

### Ring Configuration

**ID:** Once a Ring is created, This appears and can not be changed.

**Name:** This field will show the name of the Ring. If it is not filled in when creating, it will be automatically named by the rule “RingID”.

**Version:** The version of Ring can be changed here. There are three modes to choose: Rapid Super Ring as default; Super ring for compatible with Korenix 1<sup>st</sup> general ring and Any Ring for compatible with other version of rings.

**Device Priority:** The switch with highest priority (highest value) will be automatically selected as Ring Master. Then one of the ring ports in this switch will become forwarding port and the other one will become blocking port. If all of the switches have the same priority, the switch with the biggest MAC address will be selected as Ring Master.

**Ring Port1:** In Rapid Super Ring environment, you should have 2 Ring Ports. No matter this switch is Ring Master or not, when configuring RSR, 2 ports should be selected to be Ring Ports. For Ring Master, one of the ring ports will become the forwarding port and the other one will become the blocking port.

**Path Cost:** Change the Path Cost of Ring Port1. If this switch is the Ring Master of a Ring, then it determines the blocking port. The Port with higher Path Cost in the two ring ports will become the blocking port, If the Path Cost is the same, the port with larger port number will become the blocking port.

**Ring Port2:** Assign another port for ring connection

**Path Cost:** Change the Path Cost of Ring Port2

**Rapid Dual Homing:** Rapid Dual Homing is an important feature of Korenix 3<sup>rd</sup> generation Ring redundancy technology. When you want to connect multiple RSR or form redundant topology with other vendors, RDH could allow you to have maximum 7 multiple links for redundancy without any problem.

In Dual Homing I released with JetNet 4000/4500 series, you have to configure additional port as Dual Homing port to two uplink switches. In Rapid Dual Homing, you don't need to configure specific port to connect to other protocol. The Rapid



Dual Homing will smartly choose the fastest link for primary link and block all the other link to avoid loop. If the primary link failed, Rapid Dual Homing will automatically forward the secondary link for network redundant. Of course, if there are more connections, they will be standby links and recover one of them if both primary and secondary links are broken.

**Ring status:** To enable/disable the Ring. Please remember to enable the ring after you add it.

**MultiRing:** The MultiRing technology is one of the patterns of the MSR technology; it allows you to aggregate multiple rings within one switch. Create multiple ring ID and assign different ring port 1 and port 2 to each ring, thus the switch can have multiple rings in one JetNet Switch.

When implementing MultiRing, remember that the different rings can NOT use the same ring ID. The other settings are the same as above description. Technically, the maximum ring volume the MultiRing supported is up to 16 rings. Due the limited number of ports, the number of ring network is the half of port number.

**TrunkRing:** The MultiRing technology is part of the MSR technology which combines the MSR with the port trunking technology. After multiple ports aggregated, this is so-call port trunking (Staticly or learnt by LACP protocol), the Trunk ID can be one of the port ID of the MSR technology. Configured the port trunking first then you can add the Trunk group as a Ring Port in managed switch.

## 4.4.8 Ring Info (The same as 4.4.4 of previous version manual.)

This page shows the RSR information.

| Multiple Super Ring Information |                  |       |        |                |               |                       |                             |
|---------------------------------|------------------|-------|--------|----------------|---------------|-----------------------|-----------------------------|
| ID                              | Version          | Role  | Status | RM MAC         | Blocking Port | Role Transition Count | Ring State Transition Count |
| 1                               | Rapid Super Ring | nonRM | Normal | 0012.7760.b15b | Port2         | 13                    | 29                          |
|                                 |                  |       |        |                |               |                       |                             |

**ID:** Ring ID.

**Version:** which version of this ring, this field could be Rapid Super Ring, Super Ring, or Any Ring

**Role:** This Switch is RM or nonRM

**Status:** If this field is Normal which means the redundancy is approved. If any one of the link in this Ring is broken, then the status will be Abnormal.

**RM MAC:** The MAC address of Ring Master of this Ring. It helps to find the redundant path.

**Blocking Port:** This field shows which is blocked port of RM.

**Role Transition Count:** This means how many times this switch has changed its Role from nonRM to RM or from RM to nonRM.

**Role state Transition Count:** This number means how many times the Ring status has been transformed between Normal and Abnormal state.

## 4.4.9 Command Lines:

| Feature                         | Command Line                         |
|---------------------------------|--------------------------------------|
| <b>Global (STP, RSTP, MSTP)</b> |                                      |
| Enable                          | Switch(config)# spanning-tree enable |

|                                                             |                                                                                                                                                                                                                                                                                                                                                                                                                                                                                                                                                                                                                                                                                                                                                                                                                                                                                   |
|-------------------------------------------------------------|-----------------------------------------------------------------------------------------------------------------------------------------------------------------------------------------------------------------------------------------------------------------------------------------------------------------------------------------------------------------------------------------------------------------------------------------------------------------------------------------------------------------------------------------------------------------------------------------------------------------------------------------------------------------------------------------------------------------------------------------------------------------------------------------------------------------------------------------------------------------------------------|
| Disable                                                     | Switch (config)# spanning-tree disable                                                                                                                                                                                                                                                                                                                                                                                                                                                                                                                                                                                                                                                                                                                                                                                                                                            |
| Mode (Choose the Spanning Tree mode)                        | Switch(config)# spanning-tree mode<br>rst the rapid spanning-tree protocol (802.1w)<br>stp the spanning-tree prtocol (802.1d)<br>mst the multiple spanning-tree protocol (802.1s)                                                                                                                                                                                                                                                                                                                                                                                                                                                                                                                                                                                                                                                                                                 |
| Bridge Priority                                             | Switch(config)# spanning-tree priority<br><0-61440> valid range is 0 to 61440 in multiple of 4096<br>Switch(config)# spanning-tree priority 4096                                                                                                                                                                                                                                                                                                                                                                                                                                                                                                                                                                                                                                                                                                                                  |
| Bridge Times                                                | Switch(config)# spanning-tree bridge-times (forward Delay)<br>(max-age) (Hello Time)<br>Switch(config)# spanning-tree bridge-times 15 20 2<br><br>This command allows you configure all the timing in one time.                                                                                                                                                                                                                                                                                                                                                                                                                                                                                                                                                                                                                                                                   |
| Forward Delay                                               | Switch(config)# spanning-tree forward-time<br><4-30> Valid range is 4~30 seconds<br>Switch(config)# spanning-tree forward-time 15                                                                                                                                                                                                                                                                                                                                                                                                                                                                                                                                                                                                                                                                                                                                                 |
| Max Age                                                     | Switch(config)# spanning-tree max-age<br><6-40> Valid range is 6~40 seconds<br>Switch(config)# spanning-tree max-age 20                                                                                                                                                                                                                                                                                                                                                                                                                                                                                                                                                                                                                                                                                                                                                           |
| Hello Time                                                  | Switch(config)# spanning-tree hello-time<br><1-10> Valid range is 1~10 seconds<br>Switch(config)# spanning-tree hello-time 2                                                                                                                                                                                                                                                                                                                                                                                                                                                                                                                                                                                                                                                                                                                                                      |
| <b>MSTP</b>                                                 |                                                                                                                                                                                                                                                                                                                                                                                                                                                                                                                                                                                                                                                                                                                                                                                                                                                                                   |
| Enter the MSTP Configuration Tree                           | Switch(config)# spanning-tree mst<br>MSTMAP the mst instance number or range<br>configuration enter mst configuration mode<br>forward-time the forward dleay time<br>hello-time the hello time<br>max-age the message maximum age time<br>max-hops the maximum hops<br>sync sync port state of exist vlan entry<br>Switch(config)# spanning-tree mst configuration<br>Switch(config)# spanning-tree mst configuration<br>Switch(config-mst)#<br>abort exit current mode and discard all changes<br>end exit current mode, change to enable mode and apply all changes<br><br>exit exit current mode and apply all changes<br>instance the mst instance<br>list Print command list<br>name the name of mst region<br>no Negate a command or set its defaults<br>quit exit current mode and apply all changes<br>revision the revision of mst region<br>show show mst configuration |
| Region Configuration                                        | Region Name:<br>Switch(config-mst)# name<br>NAME the name string<br>Switch(config-mst)# name korenix<br>Region Revision:<br>Switch(config-mst)# revision<br><0-65535> the value of revision<br>Switch(config-mst)# revision 65535                                                                                                                                                                                                                                                                                                                                                                                                                                                                                                                                                                                                                                                 |
| Mapping Instance to VLAN (Ex: Mapping VLAN 2 to Instance 1) | Switch(config-mst)# instance<br><1-15> target instance number<br>Switch(config-mst)# instance 1 vlan<br>VLANMAP target vlan number(ex.10) or range(ex.1-10)                                                                                                                                                                                                                                                                                                                                                                                                                                                                                                                                                                                                                                                                                                                       |

|                                                                                                                  |                                                                                                                                                                                                                                                                                                                                                                                                                                                                                     |
|------------------------------------------------------------------------------------------------------------------|-------------------------------------------------------------------------------------------------------------------------------------------------------------------------------------------------------------------------------------------------------------------------------------------------------------------------------------------------------------------------------------------------------------------------------------------------------------------------------------|
|                                                                                                                  | Switch(config-mst)# instance 1 vlan 2                                                                                                                                                                                                                                                                                                                                                                                                                                               |
| Display Current MST Configuraion                                                                                 | Switch(config-mst)# show current<br>Current MST configuration<br>Name [korenix]<br>Revision 65535<br>Instance Vlans Mapped<br>-----<br>0 1,4-4094<br>1 2<br>2 3<br>-----<br>Config HMAC-MD5 Digest:<br>0xB41829F9030A054FB74EF7A8587FF58D<br>-----                                                                                                                                                                                                                                  |
| Remove Region Name                                                                                               | Switch(config-mst)# no<br>name name configure<br>revision revision configure<br>instance the mst instance<br>Switch(config-mst)# no name                                                                                                                                                                                                                                                                                                                                            |
| Remove Instance example                                                                                          | Switch(config-mst)# no instance<br><1-15> target instance number<br>Switch(config-mst)# no instance 2                                                                                                                                                                                                                                                                                                                                                                               |
| Show Pending MST Configuration                                                                                   | Switch(config-mst)# show pending<br>Pending MST configuration<br>Name [] (->The name is removed by no name)<br>Revision 65535<br>Instance Vlans Mapped<br>-----<br>0 1,3-4094<br>1 2 (->Instance 2 is removed by no instance 2)<br>-----<br>Config HMAC-MD5 Digest:<br>0x3AB68794D602FDF43B21C0B37AC3BCA8<br>-----                                                                                                                                                                  |
| Apply the setting and go to the configuration mode                                                               | Switch(config-mst)# quit<br>apply all mst configuration changes<br>Switch(config)#                                                                                                                                                                                                                                                                                                                                                                                                  |
| Apply the setting and go to the global mode                                                                      | Switch(config-mst)# end<br>apply all mst configuration changes<br>Switch#                                                                                                                                                                                                                                                                                                                                                                                                           |
| Abort the Setting and go to the configuration mode.<br><br>Show Pending to see the new settings are not applied. | Switch(config-mst)# abort<br>discard all mst configuration changes<br>Switch(config)# spanning-tree mst configuration<br>Switch(config-mst)# show pending<br>Pending MST configuration<br>Name [korenix] (->The nameis not applied after Abort settings.)<br>Revision 65535<br>Instance Vlans Mapped<br>-----<br>0 1,4-4094<br>1 2<br>2 3 (-> The instance is not applied after Abort settings.)<br>-----<br>Config HMAC-MD5 Digest:<br>0xB41829F9030A054FB74EF7A8587FF58D<br>----- |
| <b>RSTP</b>                                                                                                      |                                                                                                                                                                                                                                                                                                                                                                                                                                                                                     |

|                                |                                                                                                                                                                                                                                                                                                                                                                                                                                                                                                                                                                                                                                                                        |
|--------------------------------|------------------------------------------------------------------------------------------------------------------------------------------------------------------------------------------------------------------------------------------------------------------------------------------------------------------------------------------------------------------------------------------------------------------------------------------------------------------------------------------------------------------------------------------------------------------------------------------------------------------------------------------------------------------------|
| System RSTP Setting            | The mode should be rst, the timings can be configured in global settings listed in above.                                                                                                                                                                                                                                                                                                                                                                                                                                                                                                                                                                              |
| <b>Port Configuration Mode</b> |                                                                                                                                                                                                                                                                                                                                                                                                                                                                                                                                                                                                                                                                        |
| Port Configuraiton             | Switch(config)# interface fa1<br>Switch(config-if)# spanning-tree<br>bpdufilter      a secure BPDU process on edge-port interfae<br>bpduguard      a secure response to invalid<br>configurations(received BPDU sent by self)<br>cost            change an interafce's spanning-tree port path cost<br>edge-port      interface attached to a LAN segment that is at the<br>end of a bridged LAN or to an end node<br>link-type      the link type for the Rapid Spanning Tree<br>mst             the multiple spanning-tree<br>port-priority   the spanning tree port priority                                                                                        |
| Port Path Cost                 | Switch(config-if)# spanning-tree cost<br><1-200000000> 16-bit based value range from 1-65535, 32-bit based<br>value range<br>from 1-200,000,000<br>Switch(config-if)# spanning-tree cost 200000                                                                                                                                                                                                                                                                                                                                                                                                                                                                        |
| Port Priority                  | Switch(config-if)# spanning-tree port-priority<br><0-240>    Number from 0 to 240, in multiple of 16<br>Switch(config-if)# spanning-tree port-priority 128                                                                                                                                                                                                                                                                                                                                                                                                                                                                                                             |
| Link Type - Auto               | Switch(config-if)# spanning-tree link-type auto                                                                                                                                                                                                                                                                                                                                                                                                                                                                                                                                                                                                                        |
| Link Type - P2P                | Switch(config-if)# spanning-tree link-type point-to-point                                                                                                                                                                                                                                                                                                                                                                                                                                                                                                                                                                                                              |
| Link Type – Share              | Switch(config-if)# spanning-tree link-type shared                                                                                                                                                                                                                                                                                                                                                                                                                                                                                                                                                                                                                      |
| Edge Port                      | Switch(config-if)# spanning-tree edge-port enable<br>Switch(config-if)# spanning-tree edge-port disable                                                                                                                                                                                                                                                                                                                                                                                                                                                                                                                                                                |
| <b>MSTP Port Configuration</b> | Switch(config-if)# spanning-tree mst MSTMAP cost<br><1-200000000> the value of mst instance port cost<br>Switch(config-if)# spanning-tree mst MSTMAP port-priority<br><0-240>    the value of mst instance port priority in multiple of 16                                                                                                                                                                                                                                                                                                                                                                                                                             |
| <b>Global Information</b>      |                                                                                                                                                                                                                                                                                                                                                                                                                                                                                                                                                                                                                                                                        |
| <b>Active Information</b>      | Switch# show spanning-tree active<br>Spanning-Tree : Enabled                    Protocol : MSTP<br>Root Address : 0012.77ee.eeee   Priority : 32768<br>Root Path Cost : 0                         Root Port : N/A<br>Root Times : max-age 20, hello-time 2, forward-delay 15<br>Bridge Address : 0012.77ee.eeee   Priority : 32768<br>Bridge Times : max-age 20, hello-time 2, forward-delay 15<br>BPDU transmission-limit : 3<br><br>Port      Role      State      Cost      Prio.Nbr    Type      Aggregated<br>-----<br>fa1    Designated Forwarding    200000    128.1    P2P(RSTP)    N/A<br>fa2    Designated Forwarding    200000    128.2    P2P(RSTP)    N/A |
| RSTP Summary                   | Switch# show spanning-tree summary<br>Switch is in rapid-stp mode.<br>BPDU skewing detection disabled for the bridge.<br>Backbonefast disabled for bridge.<br>Summary of connected spanning tree ports :<br>#Port-State Summary<br>Blocking   Listening   Learning   Forwarding   Disabled<br>-----<br>0            0            0            2            8<br>#Port Link-Type Summary<br>AutoDetected   PointToPoint   SharedLink   EdgePort<br>-----                                                                                                                                                                                                                |

|                             | 9                                                                                                                                                                                                                                                                                                                                                                                                                                                                                                                                                                                                                                                                                                                                                                                  | 0 | 1 | 9 |
|-----------------------------|------------------------------------------------------------------------------------------------------------------------------------------------------------------------------------------------------------------------------------------------------------------------------------------------------------------------------------------------------------------------------------------------------------------------------------------------------------------------------------------------------------------------------------------------------------------------------------------------------------------------------------------------------------------------------------------------------------------------------------------------------------------------------------|---|---|---|
| Port Info                   | <pre>Switch# show spanning-tree port detail fa7 (Interface_ID) Rapid Spanning-Tree feature      Enabled Port 128.6 as Disabled Role is in Disabled State Port Path Cost 200000, Port Identifier 128.6 RSTP Port Admin Link-Type is Auto, Oper Link-Type is Point-to-Point RSTP Port Admin Edge-Port is Enabled, Oper Edge-Port is Edge Designated root has priority 32768, address 0012.7700.0112 Designated bridge has priority 32768, address 0012.7760.1aec Designated Port ID is 128.6, Root Path Cost is 600000 Timers : message-age 0 sec, forward-delay 0 sec  Link Aggregation Group: N/A, Type: N/A, Aggregated with: N/A  BPDU: sent 43759 , received 4854 TCN : sent 0 , received 0 Forwarding-State Transmit count   12 Message-Age Expired count</pre>                |   |   |   |
| <b>MSTP Information</b>     |                                                                                                                                                                                                                                                                                                                                                                                                                                                                                                                                                                                                                                                                                                                                                                                    |   |   |   |
| MSTP Configuraiton          | <pre>Switch# show spanning-tree mst configuration Current MST configuration (MSTP is Running) Name      [korenix] Revision  65535 Instance  Vlans Mapped ----- 0         1,4-4094 1         2 2         3 -----  Config HMAC-MD5 Digest: 0xB41829F9030A054FB74EF7A8587FF58D -----</pre>                                                                                                                                                                                                                                                                                                                                                                                                                                                                                            |   |   |   |
| Display all MST Information | <pre>Switch# show spanning-tree mst ##### MST00  vlans mapped: 1,4-4094 Bridge      address 0012.77ee.eeee  priority  32768 (sysid 0) Root        this switch for CST and IST Configured  max-age  2, hello-time 15, forward-delay 20, max-hops 20  Port  Role          State      Cost     Prio.Nbr  Type ----- fa1  Designated  Forwarding 200000  128.1    P2P Internal(MSTP) fa2  Designated  Forwarding 200000  128.2    P2P Internal(MSTP)  ##### MST01  vlans mapped: 2 Bridge      address 0012.77ee.eeee  priority  32768 (sysid 1) Root        this switch for MST01  Port  Role          State      Cost     Prio.Nbr  Type ----- fa1  Designated  Forwarding 200000  128.1    P2P Internal(MSTP) fa2  Designated  Forwarding 200000  128.2    P2P Internal(MSTP)</pre> |   |   |   |
| MSTP Root Information       | <pre>Switch# show spanning-tree mst root MST  Root      Root  Root  Root  Root  Max  Hello  Fwd Instance  Address    Priority Cost  Port  age   2    15 ----- MST00  0012.77ee.eeee  32768  0    N/A  20   2    15 MST01  0012.77ee.eeee  32768  0    N/A  20   2    15</pre>                                                                                                                                                                                                                                                                                                                                                                                                                                                                                                      |   |   |   |

|                            | MST02 0012.77ee.eeee 32768 0 N/A 20 2 15                                                                                                                                                                                                                                                                                                                                                                                                                                                                                                                                                                                                                                                                                                                                                      |                 |        |          |                    |          |       |     |            |            |        |       |                    |     |            |            |        |       |                    |   |            |            |        |       |   |
|----------------------------|-----------------------------------------------------------------------------------------------------------------------------------------------------------------------------------------------------------------------------------------------------------------------------------------------------------------------------------------------------------------------------------------------------------------------------------------------------------------------------------------------------------------------------------------------------------------------------------------------------------------------------------------------------------------------------------------------------------------------------------------------------------------------------------------------|-----------------|--------|----------|--------------------|----------|-------|-----|------------|------------|--------|-------|--------------------|-----|------------|------------|--------|-------|--------------------|---|------------|------------|--------|-------|---|
| MSTP Instance Information  | <pre>Switch# show spanning-tree mst 1 ##### MST01 vlans mapped: 2 Bridge address 0012.77ee.eeee priority 32768 (sysid 1) Root this switch for MST01</pre> <table border="1"> <thead> <tr> <th>Port</th> <th>Role</th> <th>State</th> <th>Cost</th> <th>Prio.Nbr</th> <th>Type</th> </tr> </thead> <tbody> <tr> <td>fa1</td> <td>Designated</td> <td>Forwarding</td> <td>200000</td> <td>128.1</td> <td>P2P Internal(MSTP)</td> </tr> <tr> <td>fa2</td> <td>Designated</td> <td>Forwarding</td> <td>200000</td> <td>128.2</td> <td>P2P Internal(MSTP)</td> </tr> </tbody> </table>                                                                                                                                                                                                             | Port            | Role   | State    | Cost               | Prio.Nbr | Type  | fa1 | Designated | Forwarding | 200000 | 128.1 | P2P Internal(MSTP) | fa2 | Designated | Forwarding | 200000 | 128.2 | P2P Internal(MSTP) |   |            |            |        |       |   |
| Port                       | Role                                                                                                                                                                                                                                                                                                                                                                                                                                                                                                                                                                                                                                                                                                                                                                                          | State           | Cost   | Prio.Nbr | Type               |          |       |     |            |            |        |       |                    |     |            |            |        |       |                    |   |            |            |        |       |   |
| fa1                        | Designated                                                                                                                                                                                                                                                                                                                                                                                                                                                                                                                                                                                                                                                                                                                                                                                    | Forwarding      | 200000 | 128.1    | P2P Internal(MSTP) |          |       |     |            |            |        |       |                    |     |            |            |        |       |                    |   |            |            |        |       |   |
| fa2                        | Designated                                                                                                                                                                                                                                                                                                                                                                                                                                                                                                                                                                                                                                                                                                                                                                                    | Forwarding      | 200000 | 128.2    | P2P Internal(MSTP) |          |       |     |            |            |        |       |                    |     |            |            |        |       |                    |   |            |            |        |       |   |
| MSTP Port Information      | <pre>Switch# show spanning-tree mst interface fa1 Interface fastethernet1 of MST00 is Designated Forwarding Edge Port : Edge (Edge) BPDU Filter : Disabled Link Type : Auto (Point-to-point) BPDU Guard : Disabled Boundary : Internal(MSTP) BPDUs : sent 6352, received 0</pre> <table border="1"> <thead> <tr> <th>Instance mapped</th> <th>Role</th> <th>State</th> <th>Cost</th> <th>Prio.Nbr</th> <th>Vlans</th> </tr> </thead> <tbody> <tr> <td>0</td> <td>Designated</td> <td>Forwarding</td> <td>200000</td> <td>128.1</td> <td>1,4-4094</td> </tr> <tr> <td>1</td> <td>Designated</td> <td>Forwarding</td> <td>200000</td> <td>128.1</td> <td>2</td> </tr> <tr> <td>2</td> <td>Designated</td> <td>Forwarding</td> <td>200000</td> <td>128.1</td> <td>3</td> </tr> </tbody> </table> | Instance mapped | Role   | State    | Cost               | Prio.Nbr | Vlans | 0   | Designated | Forwarding | 200000 | 128.1 | 1,4-4094           | 1   | Designated | Forwarding | 200000 | 128.1 | 2                  | 2 | Designated | Forwarding | 200000 | 128.1 | 3 |
| Instance mapped            | Role                                                                                                                                                                                                                                                                                                                                                                                                                                                                                                                                                                                                                                                                                                                                                                                          | State           | Cost   | Prio.Nbr | Vlans              |          |       |     |            |            |        |       |                    |     |            |            |        |       |                    |   |            |            |        |       |   |
| 0                          | Designated                                                                                                                                                                                                                                                                                                                                                                                                                                                                                                                                                                                                                                                                                                                                                                                    | Forwarding      | 200000 | 128.1    | 1,4-4094           |          |       |     |            |            |        |       |                    |     |            |            |        |       |                    |   |            |            |        |       |   |
| 1                          | Designated                                                                                                                                                                                                                                                                                                                                                                                                                                                                                                                                                                                                                                                                                                                                                                                    | Forwarding      | 200000 | 128.1    | 2                  |          |       |     |            |            |        |       |                    |     |            |            |        |       |                    |   |            |            |        |       |   |
| 2                          | Designated                                                                                                                                                                                                                                                                                                                                                                                                                                                                                                                                                                                                                                                                                                                                                                                    | Forwarding      | 200000 | 128.1    | 3                  |          |       |     |            |            |        |       |                    |     |            |            |        |       |                    |   |            |            |        |       |   |
| <b>Multiple Super Ring</b> |                                                                                                                                                                                                                                                                                                                                                                                                                                                                                                                                                                                                                                                                                                                                                                                               |                 |        |          |                    |          |       |     |            |            |        |       |                    |     |            |            |        |       |                    |   |            |            |        |       |   |
| Create or configure a Ring | <pre>Switch(config)# multiple-super-ring 1 Ring 1 created Switch(config-multiple-super-ring)# <b>Note: 1 is the target Ring ID which is going to be created or configured.</b></pre>                                                                                                                                                                                                                                                                                                                                                                                                                                                                                                                                                                                                          |                 |        |          |                    |          |       |     |            |            |        |       |                    |     |            |            |        |       |                    |   |            |            |        |       |   |
| Super Ring Version         | <pre>Switch(config-multiple-super-ring)# version any-ring any ring auto detection default set default to rapid super ring rapid-super-ring rapid super ring super-ring super ring</pre> <pre>Switch(config-multiple-super-ring)# version rapid-super-ring</pre>                                                                                                                                                                                                                                                                                                                                                                                                                                                                                                                               |                 |        |          |                    |          |       |     |            |            |        |       |                    |     |            |            |        |       |                    |   |            |            |        |       |   |
| Priority                   | <pre>Switch(config-multiple-super-ring)# priority &lt;0-255&gt; valid range is 0 to 255 default set default Switch(config)# super-ring priority 100</pre>                                                                                                                                                                                                                                                                                                                                                                                                                                                                                                                                                                                                                                     |                 |        |          |                    |          |       |     |            |            |        |       |                    |     |            |            |        |       |                    |   |            |            |        |       |   |
| Ring Port                  | <pre>Switch(config-multiple-super-ring)# port IFLIST Interface list, ex: fa1,fa3-5,gi8-10 cost path cost Switch(config-multiple-super-ring)# port fa1,fa2</pre>                                                                                                                                                                                                                                                                                                                                                                                                                                                                                                                                                                                                                               |                 |        |          |                    |          |       |     |            |            |        |       |                    |     |            |            |        |       |                    |   |            |            |        |       |   |
| Ring Port Cost             | <pre>Switch(config-multiple-super-ring)# port cost &lt;0-255&gt; valid range is 0 or 255 default set default (128)valid range is 0 or 255 Switch(config-multiple-super-ring)# port cost 100 &lt;0-255&gt; valid range is 0 or 255 default set default (128)valid range is 0 or 255 Switch(config-super-ring-plus)# port cost 100 200 Set path cost success.</pre>                                                                                                                                                                                                                                                                                                                                                                                                                             |                 |        |          |                    |          |       |     |            |            |        |       |                    |     |            |            |        |       |                    |   |            |            |        |       |   |
| Rapid Dual Homing          | <pre>Switch(config-multiple-super-ring)# rapid-dual-homing enable  Switch(config-multiple-super-ring)# rapid-dual-homing disable  Switch(config-multiple-super-ring)# rapid-dual-homing port</pre>                                                                                                                                                                                                                                                                                                                                                                                                                                                                                                                                                                                            |                 |        |          |                    |          |       |     |            |            |        |       |                    |     |            |            |        |       |                    |   |            |            |        |       |   |



|                  |                                                                                                                                                                                                                                                                                                                                                                                                                                                                                                                                                                                                                                                                                   |
|------------------|-----------------------------------------------------------------------------------------------------------------------------------------------------------------------------------------------------------------------------------------------------------------------------------------------------------------------------------------------------------------------------------------------------------------------------------------------------------------------------------------------------------------------------------------------------------------------------------------------------------------------------------------------------------------------------------|
|                  | <p>IFLIST            Interface name, ex: fastethernet1 or gi8<br/> auto-detect    up link auto detection<br/> IFNAME           Interface name, ex: fastethernet1 or gi8<br/> Switch(config-multiple-super-ring)# rapid-dual-homing port fa3,fa5-6<br/> set Rapid Dual Homing port success.<br/> Note: auto-detect is recommended for dual Homing..</p>                                                                                                                                                                                                                                                                                                                            |
| <b>Ring Info</b> |                                                                                                                                                                                                                                                                                                                                                                                                                                                                                                                                                                                                                                                                                   |
| <p>Ring Info</p> | <pre>Switch# show multiple-super-ring [Ring ID] [Ring1] Ring1 Current Status : Disabled Role           : Disabled Ring Status   : Abnormal Ring Manager  : 0000.0000.0000 Blocking Port : N/A Giga Copper   : N/A Configuration : Version       : Rapid Super Ring Priority       : 128 Ring Port     : fa1, fa2 Path Cost     : 100, 200 Dual-Homing II : Disabled Statistics : Watchdog sent    0, received    0, missed    0 Link Up  sent    0, received    0 Link Down sent   0, received    0 Role Transition count 0 Ring State Transition count 1  Ring ID is optional. If the ring ID is typed, this command will only display the information of the target Ring.</pre> |

## 4.5 VLAN

A Virtual LAN (VLAN) is a “logical” grouping of nodes for the purpose of limiting a broadcast domain to specific members of a group without physically grouping the members together. That means, VLAN allows you to isolate network traffic so that only members of VLAN could receive traffic from the same VLAN members. Basically, creating a VLAN from a switch is the logical equivalent of physically reconnecting a group of network devices to another Layer 2 switch, without actually disconnecting these devices from their original switches.

The 8-port Industrial Ethernet Switch supports 802.1Q VLAN. 802.1Q VLAN is also known as Tag-Based VLAN. This Tag-Based VLAN allows VLAN to be created across different switches (see Figure 1). IEEE 802.1Q tag-based VLAN makes use of VLAN control information stored in a VLAN header attached to IEEE 802.3 packet frames. This tag contains a VLAN Identifier (VID) that indicates which VLAN a frame belongs to. Since each switch only has to check a frame’s tag, without the need to dissect the contents of the frame, this also saves a lot of computing resources within the switch.

Figure 4.5-1 802.1Q VLAN

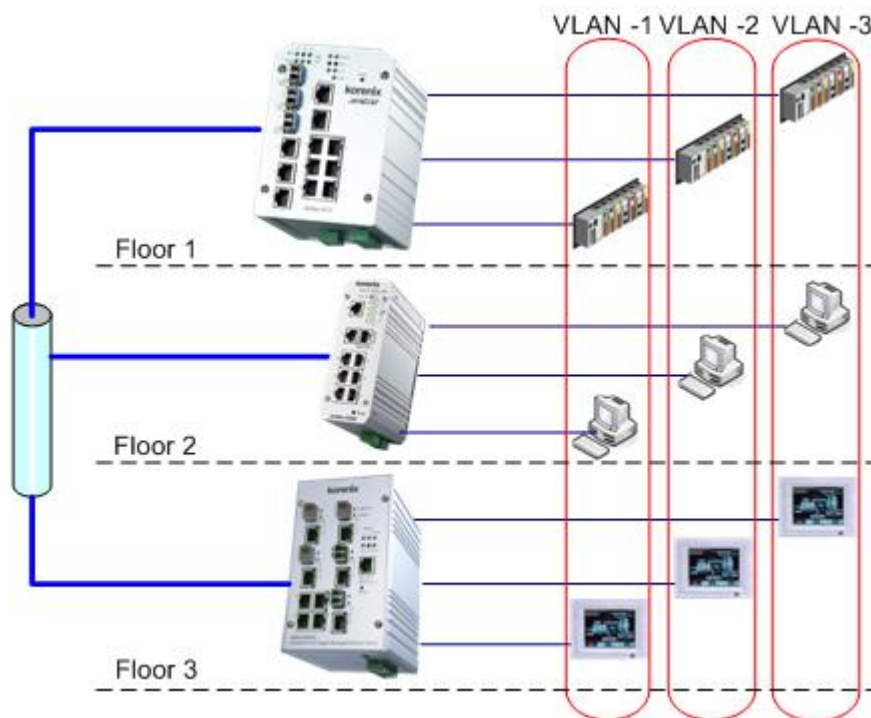

VLAN Configuration group enables you to Add/Remove VLAN, configure port Ingress/Egress parameters and view VLAN table.

Following commands are included in this group:

- 4.5.1 VLAN Port Configuration
- 4.5.2 VLAN Configuration
- 4.5.3 GVRP Configuration
- 4.5.4 VLAN Table
- 4.5.5 CLI Commands of the VLAN

#### 4.5.1 VLAN Port Configuration

VLAN Port Configuration allows you to set up VLAN port parameters to specific port. These parameters include PVID, Accept Frame Type and Ingress Filtering.

Figure 4.5-2 Web UI of VLAN configuration.

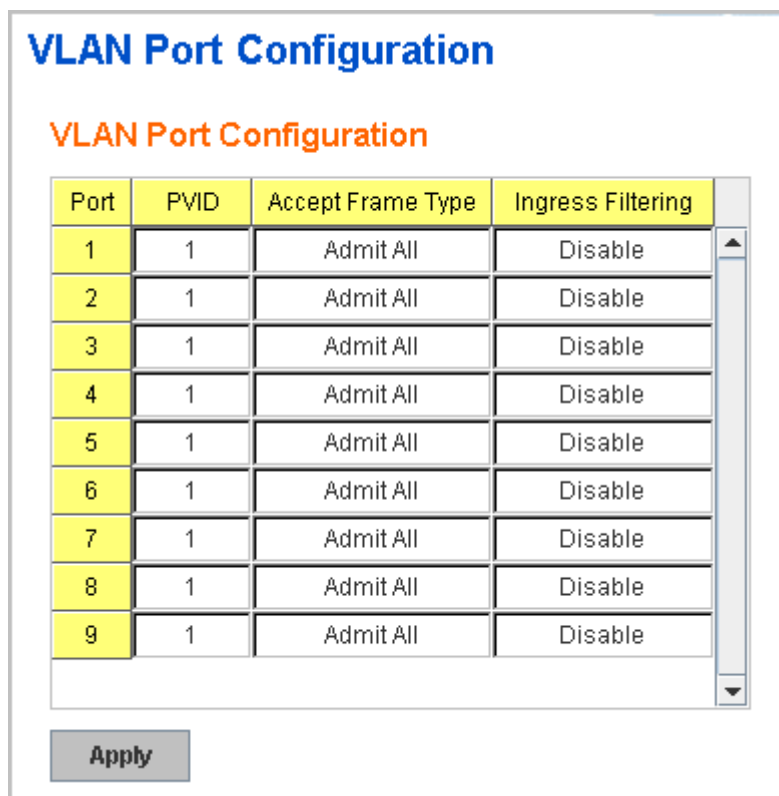

| Port | PVID | Accept Frame Type | Ingress Filtering |
|------|------|-------------------|-------------------|
| 1    | 1    | Admit All         | Disable           |
| 2    | 1    | Admit All         | Disable           |
| 3    | 1    | Admit All         | Disable           |
| 4    | 1    | Admit All         | Disable           |
| 5    | 1    | Admit All         | Disable           |
| 6    | 1    | Admit All         | Disable           |
| 7    | 1    | Admit All         | Disable           |
| 8    | 1    | Admit All         | Disable           |
| 9    | 1    | Admit All         | Disable           |

**Apply**

**PVID:** The abbreviation of the **Port VLAN ID**. Enter port VLAN ID here. PVID allows the switches to identify which port belongs to which VLAN. To keep things simple, it is recommended that PVID is equivalent to VLAN IDs.

The values of PVIDs are from 0 to 4095. But, 0 and 4095 are reserved. You can't input these 2 PVIDs. 1 is the default value. 2 to 4094 are valid and available in this column. Type the PVID you'd like to configure here.

**Accept Frame Type:** This column defines the accepted frame type of the port. There are 2 modes you can select, **Admit All** and **Tag Only**. Admit All

mode means that the port can accept both tagged and untagged packets. Tag Only mode means that the port can only accept tagged packets.

**Ingress Filtering:** Ingress filtering helps VLAN engine to filter out undesired traffic on a port. When Ingress Filtering is enabled, the port checks whether the incoming frames belong to the VLAN they claimed or not. Then the port determines if the frames can be processed or not. For example, if a tagged frame from Engineer VLAN is received, and Ingress Filtering is enabled, the switch will determine if the port is on the Engineer VLAN's Egress list. If it is, the frame can be processed. If it's not, the frame would be dropped.

## 4.5.2 VLAN Configuration

In this page, you can assign Management VLAN, create the static VLAN, and assign the Egress rule for the member ports of the VLAN.

Figure 4.5-3 Web UI of the VLAN Configuration.

**Management VLAN ID**

**Static VLAN**

| VLAN ID              | Name                 |
|----------------------|----------------------|
| <input type="text"/> | <input type="text"/> |

Sample of JetNet 5010G

**Static VLAN Configuration**

| VLAN ID | Name  | 1 | 2 | 3 | 4 | 5 | 6 | 7 | 8 | 9 | 10 |
|---------|-------|---|---|---|---|---|---|---|---|---|----|
| 1       | VLAN1 | U | U | U | U | U | U | U | U | U | U  |

**Management VLAN ID:** The switch supports management VLAN. The management VLAN ID is the VLAN ID of the CPU interface so that only member ports of the management VLAN can ping and access the switch. The default management VLAN ID is 1.

**Static VLAN:** You can assign a VLAN ID and VLAN Name for new VLAN here.

**VLAN ID** is used by the switch to identify different VLANs. Valid VLAN ID is between 1 and 4094. 1 is the default VLAN.

**VLAN Name** is a reference for network administrator to identify different VLANs. The available character is 12 for you to input. If you don't input VLAN name, the system will automatically assign VLAN name for the VLAN. The rule is VLAN (VLAN ID).

### Static VLAN

| VLAN ID | NAME |
|---------|------|
| 3       | test |

Figure 4.5-4 The steps to create a new VLAN: Type VLAN ID and NAME, and press **Add** to create a new VLAN. Then you can see the new VLAN in the Static VLAN Configuration table. Refer to Figure 4.5-5

After created the VLAN, the status of the VLAN will remain in Unused until you add ports to the VLAN.

**Note:** Before you change the management VLAN ID by Web and Telnet, remember that the port attached by the administrator should be the member port of the management VLAN; otherwise the administrator can't access the switch via the network.

**Note:** Currently the 8-port Switch only support max 256 groups VLAN.

### Static VLAN Configuration

You can see the created VLANs and specify the egress (outgoing) port rule to be **Untagged or Tagged** here.

Figure 4.5-5 below shows the Static VLAN Configuration table. You can see that new VLAN 3 (test) is created and the Egress rules of the ports are not configured now.

### Static VLAN Configuration

| VLAN ID | NAME  | 1  | 2  | 3  | 4  | 5  | 6  | 7  | 8  | 9  | 10 |
|---------|-------|----|----|----|----|----|----|----|----|----|----|
| 1       | VLAN1 | U  | U  | U  | U  | U  | U  | U  | U  | U  | U  |
| 2       | VLAN2 | -- | -- | -- | -- | -- | -- | -- | -- | -- | -- |
| 3       | test  | -- | -- | -- | -- | -- | -- | -- | -- | -- | -- |

Figure 4.5.2.4 Configure Egress rule of the ports.

### Static VLAN Configuration

| VLAN ID | NAME  | 1  | 2  | 3  | 4  | 5  | 6  | 7  | 8  | 9  | 10 |
|---------|-------|----|----|----|----|----|----|----|----|----|----|
| 1       | VLAN1 | U  | U  | U  | U  | U  | U  | U  | U  | U  | U  |
| 2       | VLAN2 | U  | U  | U  | U  | -- | -- | -- | -- | -- | -- |
| 3       | test  | -- | -- | -- | -- | U  | T  | ▼  | T  | T  | T  |

--  
U  
T

Apply
Remove
Reload

Sample of JetNet 5010G

-- : Not available

**U: Untag:** Indicates that egress/outgoing frames are not VLAN tagged.

**T : Tag:** Indicates that egress/outgoing frames are to be VLAN tagged.

Steps to configure Egress rules: Select the VLAN ID. Entry of the selected VLAN turns to light blue. Assign Egress rule of the ports to **U** or **T**. Press **Apply** to apply the setting. If you want to remove one VLAN, select the VLAN entry. Then press **Remove** button.

### 4.5.3 GVRP configuration

GVRP allows users to set-up VLANs automatically rather than manual configuration on every port of every switch in the network.

#### GVRP Configuration

**GVRP Protocol** Enable ▼

| Port | State  | Join Timer | Leave Timer | Leave All Timer |
|------|--------|------------|-------------|-----------------|
| 1    | Enable | 20         | 60          | 1000            |
| 2    | Enable | 20         | 60          | 1000            |
| 3    | Enable | 20         | 60          | 1000            |
| 4    | Enable | 20         | 60          | 1000            |
| 5    | Enable | 20         | 60          | 1000            |
| 6    | Enable | 20         | 60          | 1000            |
| 7    | Enable | 20         | 60          | 1000            |
| 8    | Enable | 20         | 60          | 1000            |
| 9    | Enable | 20         | 60          | 1000            |

Note: Timer unit is centiseconds.

Apply

Sample of JetNet 5010G

**GVRP Protocol:** Allow user to enable/disable GVRP globally.

**State:** After enable GVRP globally, here still can enable/disable GVRP by port.

**Join Timer:** Controls the interval of sending the GVRP Join BPDU. An instance of this timer is required on a per-Port, per-GARP Participant basis

**Leave Timer:** Control the time to release the GVRP reservation after received the GVRP Leave BPDU. An instance of the timer is required for each state machine that is in the LV state

**Leave All Timer:** Controls the period to initiate the garbage collection of registered VLAN. The timer is required on a per-Port, per-GARP Participant basis

#### 4.5.4 VLAN Table

This table shows you current settings of your VLAN table, including VLAN ID, Name, Status, and Egress rule of the ports.

**Your Industrial Computing & Networking Partner**

**VLAN Table**

**VLAN Table**

| VLAN ID | Name  | Status | 1  | 2  | 3  | 4  | 5  | 6  | 7  | 8  | 9  | 10 |
|---------|-------|--------|----|----|----|----|----|----|----|----|----|----|
| 1       | VLAN1 | Static | U  | U  | U  | U  | U  | U  | U  | U  | U  | U  |
| 2       | VLAN2 | Unused | -- | -- | -- | -- | -- | -- | -- | -- | -- | -- |
| 3       | test  | Static | -- | -- | U  | U  | -- | T  | T  | T  | -- | -- |

**Reload**

Sample of JetNet 5010G

**VLAN ID:** ID of the VLAN.

**Name:** Name of the VLAN.

**Status:** **Static** shows this is a manually configured static VLAN. **Unused** means this VLAN is created by UI/CLI and has no member ports. This VLAN is not workable yet. **Dynamic** means this VLAN is learnt by GVRP.

After created the VLAN, the status of this VLAN will remain in Unused status until you add ports to the VLAN.

#### 4.5.5 CLI Commands of the VLAN

Command Lines of the VLAN port configuration, VLAN configuration and VLAN table display

| Feature                                                                      | Command Line                                                                                                                                                                                                                                                                                                                                                                                                                                                                         |
|------------------------------------------------------------------------------|--------------------------------------------------------------------------------------------------------------------------------------------------------------------------------------------------------------------------------------------------------------------------------------------------------------------------------------------------------------------------------------------------------------------------------------------------------------------------------------|
| <b>VLAN Port Configuration</b>                                               |                                                                                                                                                                                                                                                                                                                                                                                                                                                                                      |
| VLAN Port PVID                                                               | Switch(config-if)# switchport trunk native vlan 2<br>Set port default vlan id to 2 success                                                                                                                                                                                                                                                                                                                                                                                           |
| Port Accept Frame Type                                                       | Switch(config)# inter fa1<br>Switch(config-if)# acceptable frame type all<br>any kind of frame type is accepted!<br>Switch(config-if)# acceptable frame type vlantaggedonly<br>only vlan-tag frame is accepted!                                                                                                                                                                                                                                                                      |
| Ingress Filtering (for fast Ethernet port 1)                                 | Switch(config)# interface fa1<br>Switch(config-if)# ingress filtering enable<br>ingress filtering enable<br>Switch(config-if)# ingress filtering disable<br>ingress filtering disable                                                                                                                                                                                                                                                                                                |
| Egress rule – Untagged (for VLAN 2)                                          | Switch(config-if)# switchport access vlan 2<br>switchport access vlan - success                                                                                                                                                                                                                                                                                                                                                                                                      |
| Egress rule – Tagged (for VLAN 2)                                            | Switch(config-if)# switchport trunk allowed vlan add 2                                                                                                                                                                                                                                                                                                                                                                                                                               |
| Display – Port Ingress Rule (PVID, Ingress Filtering, Acceptable Frame Type) | Switch# show interface fa1<br>Interface fastethernet1<br>Administrative Status : Enable<br>Operating Status : Not Connected<br>Duplex : Auto<br>Speed : Auto<br>Flow Control :off<br>Default Port VLAN ID: 2<br>Ingress Filtering : Disabled<br>Acceptable Frame Type : All<br>Port Security : Disabled<br>Auto Negotiation : Enable<br>Loopback Mode : None<br>STP Status: disabled<br>Default CoS Value for untagged packets is 0.<br>Mdix mode is Auto.<br>Medium mode is Copper. |
| Display – Port Egress Rule (Egress rule, IP address, status)                 | Switch# show running-config<br>.....<br>!<br>interface gigabitethernet1<br>switchport access vlan 1<br>switchport access vlan 3<br>switchport trunk native vlan 2<br>.....<br>interface vlan1<br>ip address 192.168.10.8/24<br>no shutdown                                                                                                                                                                                                                                           |
| <b>VLAN Configuration</b>                                                    |                                                                                                                                                                                                                                                                                                                                                                                                                                                                                      |



| Create VLAN (2)                      | <pre>Switch(config)# vlan 2 vlan 2 success  Switch(config)# interface vlan 2 Switch(config-if)#</pre> <p><i>Note: In CLI configuration, you should create a VLAN interface first. Then you can start to add/remove ports. Default status of the created VLAN is unused until you add member ports to it.</i></p>                                                                                                                                                                                                  |             |               |             |              |         |        |   |       |         |        |   |   |        |        |       |               |
|--------------------------------------|-------------------------------------------------------------------------------------------------------------------------------------------------------------------------------------------------------------------------------------------------------------------------------------------------------------------------------------------------------------------------------------------------------------------------------------------------------------------------------------------------------------------|-------------|---------------|-------------|--------------|---------|--------|---|-------|---------|--------|---|---|--------|--------|-------|---------------|
| Remove VLAN                          | <pre>Switch(config)# no vlan 2 no vlan success</pre> <p><i>Note: You can only remove the VLAN when the VLAN is in unused mode.</i></p>                                                                                                                                                                                                                                                                                                                                                                            |             |               |             |              |         |        |   |       |         |        |   |   |        |        |       |               |
| VLAN Name                            | <pre>Switch(config)# vlan 2 vlan 2 has exists Switch(config-vlan)# name v2  Switch(config-vlan)# no name</pre> <p><i>Note: Use no name to change the name to default name, VLAN VID.</i></p>                                                                                                                                                                                                                                                                                                                      |             |               |             |              |         |        |   |       |         |        |   |   |        |        |       |               |
| VLAN description                     | <pre>Switch(config)# interface vlan 2 Switch(config-if)# Switch(config-if)# description this is the VLAN 2  Switch(config-if)# no description -&gt;Delete the description.</pre>                                                                                                                                                                                                                                                                                                                                  |             |               |             |              |         |        |   |       |         |        |   |   |        |        |       |               |
| IP address of the VLAN               | <pre>Switch(config)# interface vlan 2 Switch(config-if)# Switch(config-if)# ip address 192.168.10.18/24  Switch(config-if)# no ip address 192.168.10.8/24 -&gt;Delete the IP address</pre>                                                                                                                                                                                                                                                                                                                        |             |               |             |              |         |        |   |       |         |        |   |   |        |        |       |               |
| Create multiple VLANs (VLAN 5-10)    | <pre>Switch(config)# interface vlan 5-10</pre>                                                                                                                                                                                                                                                                                                                                                                                                                                                                    |             |               |             |              |         |        |   |       |         |        |   |   |        |        |       |               |
| Shut down VLAN                       | <pre>Switch(config)# interface vlan 2 Switch(config-if)# shutdown  Switch(config-if)# no shutdown -&gt;Turn on the VLAN</pre>                                                                                                                                                                                                                                                                                                                                                                                     |             |               |             |              |         |        |   |       |         |        |   |   |        |        |       |               |
| Display – VLAN table                 | <pre>Switch# sh vlan</pre> <table border="1"> <thead> <tr> <th>VLAN Name</th> <th>Status</th> <th>Trunk Ports</th> <th>Access Ports</th> </tr> </thead> <tbody> <tr> <td>1 VLAN1</td> <td>Static</td> <td>-</td> <td>fa1-7</td> </tr> <tr> <td>2 VLAN2</td> <td>Unused</td> <td>-</td> <td>-</td> </tr> <tr> <td>3 test</td> <td>Static</td> <td>fa4-5</td> <td>fa3,fa4,fa7-8</td> </tr> </tbody> </table>                                                                                                        | VLAN Name   | Status        | Trunk Ports | Access Ports | 1 VLAN1 | Static | - | fa1-7 | 2 VLAN2 | Unused | - | - | 3 test | Static | fa4-5 | fa3,fa4,fa7-8 |
| VLAN Name                            | Status                                                                                                                                                                                                                                                                                                                                                                                                                                                                                                            | Trunk Ports | Access Ports  |             |              |         |        |   |       |         |        |   |   |        |        |       |               |
| 1 VLAN1                              | Static                                                                                                                                                                                                                                                                                                                                                                                                                                                                                                            | -           | fa1-7         |             |              |         |        |   |       |         |        |   |   |        |        |       |               |
| 2 VLAN2                              | Unused                                                                                                                                                                                                                                                                                                                                                                                                                                                                                                            | -           | -             |             |              |         |        |   |       |         |        |   |   |        |        |       |               |
| 3 test                               | Static                                                                                                                                                                                                                                                                                                                                                                                                                                                                                                            | fa4-5       | fa3,fa4,fa7-8 |             |              |         |        |   |       |         |        |   |   |        |        |       |               |
| Display – VLAN interface information | <pre>Switch# show interface vlan1 interface vlan1 is up, line protocol detection is disabled index 14 metric 1 mtu 1500 &lt;UP,BROADCAST,RUNNING,MULTICAST&gt; HWaddr: 00:12:77:ff:01:b0 inet 192.168.10.100/24 broadcast 192.168.10.255 input packets 639, bytes 38248, dropped 0, multicast packets 0 input errors 0, length 0, overrun 0, CRC 0, frame 0, fifo 0, missed 0 output packets 959, bytes 829280, dropped 0 output errors 0, aborted 0, carrier 0, fifo 0, heartbeat 0, window 0 collisions 0</pre> |             |               |             |              |         |        |   |       |         |        |   |   |        |        |       |               |
| <b>GVRP configuration</b>            |                                                                                                                                                                                                                                                                                                                                                                                                                                                                                                                   |             |               |             |              |         |        |   |       |         |        |   |   |        |        |       |               |
| GVRP enable/disable                  | <pre>Switch(config)# gvrp mode</pre>                                                                                                                                                                                                                                                                                                                                                                                                                                                                              |             |               |             |              |         |        |   |       |         |        |   |   |        |        |       |               |

|                                                                        |                                                                                                                                                                                |
|------------------------------------------------------------------------|--------------------------------------------------------------------------------------------------------------------------------------------------------------------------------|
|                                                                        | disable Disable GVRP feature globally on the switch<br>enable Enable GVRP feature globally on the switch<br>Switch(config)# gvrp mode enable<br>Gvrp is enabled on the switch! |
| Configure GVRP timer<br><br>Join timer /Leave timer/<br>LeaveAll timer | Switch(config)# inter fa1<br>Switch(config-if)# garp timer<br><10-10000><br>Switch(config-if)# garp timer 20 60 1000<br>Note: The unit of these timer is centisecond           |
| <b>Management VLAN</b>                                                 |                                                                                                                                                                                |
| Management VLAN                                                        | Switch(config)# int vlan 1 (Go to management VLAN)<br>Switch(config-if)# no shutdown                                                                                           |
| Display                                                                | Switch# show running-config<br><br>....<br>!<br>interface vlan1<br>ip address 192.168.10.17/24<br>ip igmp<br>no shutdown<br>!<br>....                                          |

## 4.6 Private VLAN

The private VLAN helps to resolve the primary VLAN ID shortage, client ports' isolation and network security issues. The Private VLAN provides primary and secondary VLAN within a single switch.

**Primary VLAN:** The uplink port is usually the primary VLAN. A primary VLAN contains promiscuous ports that can communicate with lower Secondary VLANs.

**Secondary VLAN:** The client ports are usually defined within secondary VLAN. The secondary VLAN includes Isolated VLAN and Community VLAN. The client ports can be isolated VLANs or can be grouped in the same Community VLAN. The ports within the same community VLAN can communicate with each other. However, the isolated VLAN ports can Not.

The figure shows the typical Private VLAN network. The SCADA/Public Server or NMS workstation is usually located in primary VLAN. The clients PCs or Rings are located within Secondary.

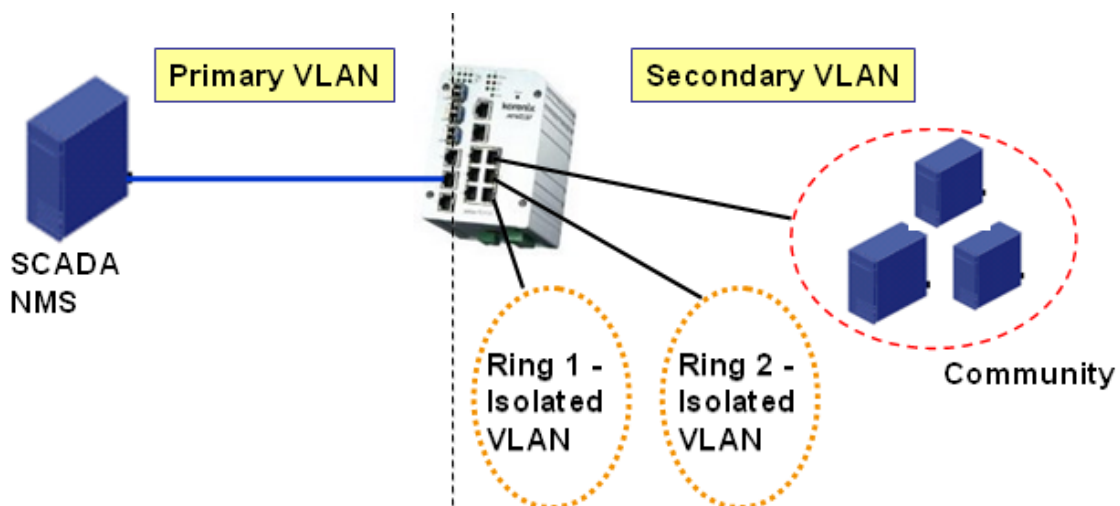

Private VLAN (PVLAN) Configuration group enables you to Configure PVLAN, PVLAN Port and see the PVLAN Information.

Following commands are included in this group:

- 4.6.1 PVLAN Configuration
- 4.6.2 PVLAN Port Configuration
- 4.6.3 CLI Commands of the PVLAN

#### 4.6.1 PVLAN Configuration

PVLAN Configuration allows you to assign Private VLAN type. After created VLAN in VLAN Configuraiton page, the available VLAN ID will display here. Choose the Private VLAN types for each VLAN you want configure.

**None:** The VLAN is Not included in Private VLAN.

**Primary:** The VLAN is the Primary VLAN. The member ports can communicate with secondary ports.

**Isolated:** The VLAN is the Isolated VLAN. The member ports of the VLAN are isolated.

**Community:** The VLAN is the Community VLAN. The member ports of the VLAN can communicate with each other.

| VLAN ID | Private VLAN Type                                                                                            |
|---------|--------------------------------------------------------------------------------------------------------------|
| 2       | Primary                                                                                                      |
| 3       | Isolated                                                                                                     |
| 4       | Community                                                                                                    |
| 5       | Isolated                                                                                                     |
|         | <ul style="list-style-type: none"> <li>None</li> <li>Primary</li> <li>Isolated</li> <li>Community</li> </ul> |

#### 4.6.2 PVLAN Port Configuration

PVLAN Port Configuration page allows configure Port Configuration and Private VLAN Association.

#### Private VLAN Association

**Secondary VLAN:** After the Isolated and Community VLAN Type is assigned in Private VLAN Configuration page, the VLANs are belonged to the Secondary VLAN and displayed here.

**Primary VLAN:** After the Primary VLAN Type is assigned in Private VLAN Configuration page, the secondary VLAN can associate to the Primary VLAN ID. Select the Primary VLAN ID here.

**Note:** Before configuring PVLAN port type, the Private VLAN Association should be done first.

## Port Configuraion

### **PVLAN Port Type :**

**Normal:** The Normal port is None PVLAN ports, it remains its original VLAN setting.

**Host:** The Host type ports can be mapped to the Secondary VLAN.

**Promiscuous:** The promiscuous port can be associated to the Primary VLAN.

**VLAN ID:** After assigned the port type, the web UI display the available VLAN ID the port can associate to.

For example:

**1. VLAN Create:** VLAN 2-5 are created in VLAN Configuration page.

**2. Private VLAN Type:** VLAN 2-5 has its Private VLAN Type configured in Private VLAN Configuration page.

VLAN 2 is belonged to Primary VLAN.

VLAN 3-5 are belonged to secondary VLAN (Isolated or Community).

**3. Private VLAN Association:** Associate VLAN 3-5 to VLAN 2 in Private VLAN Association first.

### **4. Private VLAN Port Configuraiton**

VLAN 2 – Primary -> The member port of VLAN 2 is promiscuous port.

VLAN 3 – Isolated -> The Host port can be mapped to VLAN 3.

VLAN 4 – Community -> The Host port can be mapped to VLAN 3.

VLAN 5 – Community -> The Host port can be mapped to VLAN 3.

### **5. Result:**

VLAN 2 -> VLAN 3, 4, 5; member ports can communicate with ports in secondary VLAN.

VLAN 3 -> VLAN 2, member ports are isolated, but it can communicate with member port of VLAN 2..

VLAN 4 -> VLAN 2, member ports within the community can communicate with each other and communicate with member port of VLAN 2.

VLAN 5 -> VLAN 2, member ports within the community can communicate with each other and communicate with member port of VLAN 2.

## Private VLAN Port Configuration

### Port Configuration

| Port | PVLAN Port Type | VLAN ID |
|------|-----------------|---------|
| 1    | Normal          | None    |
| 2    | Normal          | None    |
| 3    | Normal          | None    |
| 4    | Normal          | None    |
| 5    | Normal          | None    |
| 6    | Normal          | None    |
| 7    | Host            | 5       |
| 8    | Host            | 4       |
| 9    | Host            | 3       |
| 10   | Promiscuous     | 2       |

Apply

### Private VLAN Association

| Secondary VLAN | Primary VLAN |
|----------------|--------------|
| 3              | 2            |
| 4              | 2            |
| 5              | 2            |

### 4.6.3 Private VLAN Information

This page allows you to see the Private VLAN information.

## Private VLAN Information

### Private VLAN Information

| Primary VLAN | Secondary VLAN | Secondary VLAN Type | Ports |
|--------------|----------------|---------------------|-------|
| 2            | 3              | Isolated            | 10,9  |
| 2            | 4              | Community           | 10,8  |
| 2            | 5              | Community           | 10,7  |

Reload

#### 4.6.4 CLI Command of the PVLAN

##### Command Lines of the Private VLAN configuration

| Feature                                            | Command Line                                                                                                                                                                                                                                                                                                      |
|----------------------------------------------------|-------------------------------------------------------------------------------------------------------------------------------------------------------------------------------------------------------------------------------------------------------------------------------------------------------------------|
| <b>Private VLAN Configuration</b>                  |                                                                                                                                                                                                                                                                                                                   |
| Create VLAN                                        | Switch(config)# vlan 2<br>vlan 2 success<br>Switch(config-vlan)#<br>end      End current mode and change to enable mode<br>exit      Exit current mode and down to previous mode<br>list      Print command list<br>name      Assign a name to vlan<br>no          no<br>private-vlan    Configure a private VLAN |
| Private VLAN Type                                  | <b>Go to the VLAN you want configure first.</b><br>Switch(config)# vlan (VID)                                                                                                                                                                                                                                     |
| Choose the Types                                   | Switch(config-vlan)# private-vlan<br>community    Configure the VLAN as an community private VLAN<br>isolated      Configure the VLAN as an isolated private VLAN<br>primary        Configure the VLAN as a primary private VLAN                                                                                  |
| Primary Type                                       | Switch(config-vlan)# private-vlan primary<br><cr>                                                                                                                                                                                                                                                                 |
| Isolated Type                                      | Switch(config-vlan)# private-vlan isolated<br><cr>                                                                                                                                                                                                                                                                |
| Community Type                                     | Switch(config-vlan)# private-vlan community<br><cr>                                                                                                                                                                                                                                                               |
| <b>Private VLAN Port Configuraiton</b>             |                                                                                                                                                                                                                                                                                                                   |
| Go to the port configuraiton                       | Switch(config)# interface (port_number, ex: gi9)<br>Switch(config-if)# switchport private-vlan<br>host-association    Set the private VLAN host association<br>mapping              map primary VLAN to secondary VLAN                                                                                            |
| Private VLAN Port Type                             | Switch(config-if)# switchport mode<br>private-vlan    Set private-vlan mode<br>Switch(config-if)# switchport mode private-vlan<br>host            Set the mode to private-vlan host<br>promiscuous    Set the mode to private-vlan promiscuous                                                                    |
| Promiscuous Port Type                              | Switch(config-if)# switchport mode private-vlan promiscuous<br><cr>                                                                                                                                                                                                                                               |
| Host Port Type                                     | Switch(config-if)# switchport mode private-vlan host<br><cr>                                                                                                                                                                                                                                                      |
| Private VLAN Port Configuration<br>PVLAN Port Type | Switch(config)# interface gi9<br>Switch(config-if)# switchport mode private-vlan host                                                                                                                                                                                                                             |
| Host Association                                   | Switch(config-if)# switchport private-vlan host-association                                                                                                                                                                                                                                                       |

|                                                                                                 |                                                                                                                                                                                                                                                                                                 |
|-------------------------------------------------------------------------------------------------|-------------------------------------------------------------------------------------------------------------------------------------------------------------------------------------------------------------------------------------------------------------------------------------------------|
| primary to secondary<br><br>(The command is only available for host port.)                      | <2-4094> Primary range VLAN ID of the private VLAN port association<br>Switch(config-if)# switchport private-vlan host-association 2<br><2-4094> Secondary range VLAN ID of the private VLAN port association<br>Switch(config-if)# switchport private-vlan host-association 2 3                |
| Mapping primary to secondary VLANs<br><br>(This command is only available for promiscuous port) | Switch(config)# interface gi10<br><br>Switch(config-if)# switchport mode private-vlan promiscuous<br><br>Switch(config-if)# switchport private-vlan mapping 2 add 3<br>Switch(config-if)# switchport private-vlan mapping 2 add 4<br>Switch(config-if)# switchport private-vlan mapping 2 add 5 |
| <b>Private VLAN Information</b>                                                                 |                                                                                                                                                                                                                                                                                                 |
| Private VLAN Information                                                                        | Switch# show vlan private-vlan<br>FLAGS: I -> Isolated P -> Promiscuous<br>C -> Community<br>Primary Secondary Type Ports<br>-----<br>2 3 Isolated gi10(P),gi9(I)<br>2 4 Community gi10(P),gi8(C)<br>2 5 Community gi10(P),fa7(C),gi9(I)<br>10 - - -                                            |
| PVLAN Type                                                                                      | Switch# show vlan private-vlan type<br>Vlan Type Ports<br>-----<br>2 primary gi10<br>3 isolated gi9<br>4 community gi8<br>5 community fa7,gi9<br>10 primary -                                                                                                                                   |
| Host List                                                                                       | Switch# show vlan private-vlan port-list<br>Ports Mode Vlan<br>-----<br>1 normal -<br>2 normal -<br>3 normal -<br>4 normal -<br>5 normal -<br>6 normal -<br>7 host 5<br>8 host 4<br>9 host 3<br>10 promiscuous 2                                                                                |
| Running Config Information                                                                      | Switch# show run<br>Building configuration...<br><br>Current configuration:<br>hostname Switch<br>vlan learning independent<br>!<br>vlan 1<br>!<br>Private VLAN Type<br>vlan 2                                                                                                                  |

|                                      |                                                                                                                                                                                                                                                                                                                                                                                                                                                                                                                                                                                                                                                                                                                                                                                                                                                                    |
|--------------------------------------|--------------------------------------------------------------------------------------------------------------------------------------------------------------------------------------------------------------------------------------------------------------------------------------------------------------------------------------------------------------------------------------------------------------------------------------------------------------------------------------------------------------------------------------------------------------------------------------------------------------------------------------------------------------------------------------------------------------------------------------------------------------------------------------------------------------------------------------------------------------------|
| <p>Private VLAN Port Information</p> | <pre> private-vlan primary ! vlan 3 private-vlan isolated ! vlan 4 private-vlan community ! vlan 5 private-vlan community ! ..... ..... interface fastethernet7 switchport access vlan add 2,5 switchport trunk native vlan 5 switchport mode private-vlan host switchport private-vlan host-association 2 5 ! interface gigabitethernet8 switchport access vlan add 2,4 switchport trunk native vlan 4 switchport mode private-vlan host switchport private-vlan host-association 2 4 ! interface gigabitethernet9 switchport access vlan add 2,5 switchport trunk native vlan 5 switchport mode private-vlan host switchport private-vlan host-association 2 3 ! interface gigabitethernet10 switchport access vlan add 2,5 switchport trunk native vlan 2 switchport mode private-vlan promiscuous switchport private-vlan mapping 2 add 3-5 ..... ..... </pre> |
|--------------------------------------|--------------------------------------------------------------------------------------------------------------------------------------------------------------------------------------------------------------------------------------------------------------------------------------------------------------------------------------------------------------------------------------------------------------------------------------------------------------------------------------------------------------------------------------------------------------------------------------------------------------------------------------------------------------------------------------------------------------------------------------------------------------------------------------------------------------------------------------------------------------------|



## 4.7 Traffic Prioritization

Quality of Service (QoS) provides traffic prioritization mechanism which allows users to deliver better service to certain flows. QoS can also help to alleviate congestion problems and ensure high-priority traffic is delivered first. This section allows you to configure Traffic Prioritization settings for each port with regard to setting priorities.

JetNet switch's QoS supports 4 physical queues, weighted fair queuing (WRR) and Strict Priority scheme, which follows 802.1p COS tag and IPv4 TOS/DiffServ information to prioritize the traffic of your industrial network.

Following commands are included in this group:

### 4.7.1 QoS Setting

#### 4.7.2 CoS-Queue Mapping

#### 4.7.3 DSCP-Queue Mapping

#### 4.7.4 CLI Commands of the Traffic Prioritization

### 4.7.1 QoS Setting

### QoS Setting

**Queue Scheduling**

Use an 8,4,2,1 weighted fair queuing scheme  
 Use a strict priority scheme

**Port Setting**

| Port | CoS | Trust Mode   |
|------|-----|--------------|
| 1    | 0 ▼ | COS Only ▼   |
| 2    | 1 ▼ | DSCP Only ▼  |
| 3    | 2 ▼ | COS First ▼  |
| 4    | 3 ▼ | DSCP First ▼ |
| 5    | 4 ▼ | COS Only ▼   |
| 6    | 5 ▼ | COS Only ▼   |
| 7    | 6 ▼ | COS Only ▼   |
| 8    | 7 ▼ | COS Only ▼   |

COS Only  
 DSCP Only  
 COS First  
 DSCP First

## Queue Scheduling

You can select the Queue Scheduling rule as follows:

**Use an 8,4,2,1 weighted fair queuing scheme.** This is also known as **WRR** (Weight Round Robin). JetNet will follow 8:4:2:1 rate to process the packets in a queue from the highest priority to the lowest. For example, the system will process 8 packets with the highest priority in the queue, 4 with middle priority, and 2 with low priority and 1 with the lowest priority at the same time.

**Use a strict priority scheme.** Packets with higher priority in the queue will always be processed first, except that there is no packet with higher priority.

## Port Setting

**CoS** column is to indicate default port priority value for untagged or priority-tagged frames. When JetNet receives the frames, JetNet will attach the value to the CoS field of the incoming VLAN-tagged packets. You can enable 0,1,2,3,4,5,6 or 7 to the port.

**Trust Mode** is to indicate Queue Mapping types for you to select.

**COS Only:** Port priority will only follow COS-Queue Mapping you have assigned.

**DSCP Only:** Port priority will only follow DSCP-Queue Mapping you have assigned.

**COS first:** Port priority will follow COS-Queue Mapping first, and then DSCP-Queue Mapping rule.

**DSCP first:** Port priority will follow DSCP-Queue Mapping first, and then COS-Queue Mapping rule.

Default priority type is **COS Only**. The system will provide default COS-Queue table to which you can refer for the next command.

After configuration, press **Apply** to enable the settings.

### 4.7.2 CoS-Queue Mapping

This page is to change CoS values to Physical Queue mapping table. Since the switch fabric of JetNet only supports 4 physical queues, Lowest, Low, Middle and High. Users should therefore assign how to map CoS value to the level of the physical queue.

In JetNet management switch, users can freely assign the mapping table or follow the suggestion of the 802.1p standard. Korenix uses 802.1p suggestion as default values. You can find CoS values 1 and 2 are mapped to physical Queue 0, the lowest queue. CoS values 0 and 3 are mapped to physical Queue 1, the low/normal physical queue. CoS values 4 and 5 are mapped to physical Queue 2, the middle physical queue. CoS values 6 and 7 are mapped to physical Queue 3, the high physical queue.

## CoS-Queue Mapping

### CoS-Queue Mapping

|       |     |     |     |     |     |     |     |     |
|-------|-----|-----|-----|-----|-----|-----|-----|-----|
| CoS   | 0   | 1   | 2   | 3   | 4   | 5   | 6   | 7   |
| Queue | 1 ▼ | 0 ▼ | 0 ▼ | 1 ▼ | 2 ▼ | 2 ▼ | 3 ▼ | 3 ▼ |

Note: Queue 3 is the highest priority queue.

Apply

After configuration, press **Apply** to enable the settings.

### 4.7.3 DSCP-Queue Mapping

This page is to change DSCP values to Physical Queue mapping table. Since the switch fabric of JetNet only supports 4 physical queues, Lowest, Low, Middle and High. Users should therefore assign how to map DSCP value to the level of the physical queue. In JetNet, users can freely change the mapping table to follow the upper layer 3 switch or routers' DSCP setting.

## Traffic Prioritization

### DSCP-Queue Mapping

|       |     |     |     |     |     |     |     |     |
|-------|-----|-----|-----|-----|-----|-----|-----|-----|
| DSCP  | 0   | 1   | 2   | 3   | 4   | 5   | 6   | 7   |
| Queue | 1 ▼ | 1 ▼ | 1 ▼ | 1 ▼ | 1 ▼ | 1 ▼ | 1 ▼ | 1 ▼ |
| DSCP  | 8   | 9   | 10  | 11  | 12  | 13  | 14  | 15  |
| Queue | 0 ▼ | 0 ▼ | 0 ▼ | 0 ▼ | 0 ▼ | 0 ▼ | 0 ▼ | 0 ▼ |
| DSCP  | 16  | 17  | 18  | 19  | 20  | 21  | 22  | 23  |
| Queue | 0 ▼ | 0 ▼ | 0 ▼ | 0 ▼ | 0 ▼ | 0 ▼ | 0 ▼ | 0 ▼ |
| DSCP  | 24  | 25  | 26  | 27  | 28  | 29  | 30  | 31  |
| Queue | 1 ▼ | 1 ▼ | 1 ▼ | 1 ▼ | 1 ▼ | 1 ▼ | 1 ▼ | 1 ▼ |
| DSCP  | 32  | 33  | 34  | 35  | 36  | 37  | 38  | 39  |
| Queue | 2 ▼ | 2 ▼ | 2 ▼ | 2 ▼ | 2 ▼ | 2 ▼ | 2 ▼ | 2 ▼ |
| DSCP  | 40  | 41  | 42  | 43  | 44  | 45  | 46  | 47  |
| Queue | 2 ▼ | 2 ▼ | 2 ▼ | 2 ▼ | 2 ▼ | 2 ▼ | 2 ▼ | 2 ▼ |
| DSCP  | 48  | 49  | 50  | 51  | 52  | 53  | 54  | 55  |
| Queue | 3 ▼ | 3 ▼ | 3 ▼ | 3 ▼ | 3 ▼ | 3 ▼ | 3 ▼ | 3 ▼ |
| DSCP  | 56  | 57  | 58  | 59  | 60  | 61  | 62  | 63  |
| Queue | 3 ▼ | 3 ▼ | 3 ▼ | 3 ▼ | 3 ▼ | 3 ▼ | 3 ▼ | 3 ▼ |

Note: Queue 3 is the highest priority queue.

Apply

After configuration, press **Apply** to enable the settings.

#### 4.7.4 CLI Commands of the Traffic Prioritization

##### Command Lines of the Traffic Prioritization configuration

| Feature                                              | Command Line                                                                                                                                                                                                                                                                                                                 |
|------------------------------------------------------|------------------------------------------------------------------------------------------------------------------------------------------------------------------------------------------------------------------------------------------------------------------------------------------------------------------------------|
| <b>QoS Setting</b>                                   |                                                                                                                                                                                                                                                                                                                              |
| Queue Scheduling – Strict Priority                   | Switch(config)# qos queue-sched<br>sp Strict Priority<br>wrr Weighted Round Robin (Use an 8,4,2,1 weight)<br>Switch(config)# qos queue-sched sp<br><cr>                                                                                                                                                                      |
| Queue Scheduling - WRR                               | Switch(config)# qos queue-sched wrr                                                                                                                                                                                                                                                                                          |
| Port Setting – CoS (Default Port Priority)           | Switch(config)# interface <b>fa1</b><br>Switch(config-if)# qos cos<br>DEFAULT-COS Assign an priority (7 highest)<br>Switch(config-if)# qos cos 7<br>The default port CoS value is set 7 ok.<br><br><b>Note: When change the port setting, you should Select the specific port first. Ex: fa1 means fast Ethernet port 1.</b> |
| Port Setting – Trust Mode- CoS Only                  | Switch(config)# interface fa1<br>Switch(config-if)# qos trust cos<br>The port trust is set CoS only ok.                                                                                                                                                                                                                      |
| Port Setting – Trust Mode- CoS First                 | Switch(config)# interface fa1<br>Switch(config-if)# qos trust cos-first<br>The port trust is set CoS first ok.                                                                                                                                                                                                               |
| Port Setting – Trust Mode- DSCP Only                 | Switch(config)# interface fa1<br>Switch(config-if)# qos trust dscp<br>The port trust is set DSCP only ok.                                                                                                                                                                                                                    |
| Port Setting – Trust Mode- DSCP First                | Switch(config)# interface fa1<br>Switch(config-if)# qos trust dscp-first<br>The port trust is set DSCP first ok.                                                                                                                                                                                                             |
| Display – Queue Scheduling                           | Switch# show qos queue-sched<br>QoS queue scheduling scheme : Weighted Round Robin (Use an 8,4,2,1 weight)                                                                                                                                                                                                                   |
| Display – Port Setting - Trust Mode                  | Switch# show qos trust<br>QoS Port Trust Mode :<br>Port Trust Mode<br>-----+-----<br>1 DSCP first<br>2 COS only<br>3 COS only<br>4 COS only<br>5 COS only<br>6 COS only<br>7 COS only<br>8 COS only                                                                                                                          |
| Display – Port Setting – CoS (Port Default Priority) | Switch# show qos port-cos<br>Port Default Cos :<br>Port CoS<br>-----+-----<br>1 7<br>2 0<br>3 0                                                                                                                                                                                                                              |

|                              |                                                                                                                                                                                                                   |
|------------------------------|-------------------------------------------------------------------------------------------------------------------------------------------------------------------------------------------------------------------|
|                              | <pre> 4 0 5 0 6 0 7 0 8 0 </pre>                                                                                                                                                                                  |
| <b>CoS-Queue Mapping</b>     |                                                                                                                                                                                                                   |
| Format                       | <pre> Switch(config)# qos cos-map   PRIORITY Assign an priority (7 highest) Switch(config)# qos cos-map 1   QUEUE Assign an queue (0-3) </pre> <p><b>Note: Format: qos cos-map priority_value queue_value</b></p> |
| Map CoS 0 to Queue 1         | <pre> Switch(config)# qos cos-map 0 1 The CoS to queue mapping is set ok. </pre>                                                                                                                                  |
| Map CoS 1 to Queue 0         | <pre> Switch(config)# qos cos-map 1 0 The CoS to queue mapping is set ok. </pre>                                                                                                                                  |
| Map CoS 2 to Queue 0         | <pre> Switch(config)# qos cos-map 2 0 The CoS to queue mapping is set ok. </pre>                                                                                                                                  |
| Map CoS 3 to Queue 1         | <pre> Switch(config)# qos cos-map 3 1 The CoS to queue mapping is set ok. </pre>                                                                                                                                  |
| Map CoS 4 to Queue 2         | <pre> Switch(config)# qos cos-map 4 2 The CoS to queue mapping is set ok. </pre>                                                                                                                                  |
| Map CoS 5 to Queue 2         | <pre> Switch(config)# qos cos-map 5 2 The CoS to queue mapping is set ok. </pre>                                                                                                                                  |
| Map CoS 6 to Queue 3         | <pre> Switch(config)# qos cos-map 6 3 The CoS to queue mapping is set ok. </pre>                                                                                                                                  |
| Map CoS 7 to Queue 3         | <pre> Switch(config)# qos cos-map 7 3 The CoS to queue mapping is set ok. </pre>                                                                                                                                  |
| Display – CoS-Queue mapping  | <pre> Switch# sh qos cos-map CoS to Queue Mapping : CoS  Queue ---- +  ----- 0      1 1      0 2      0 3      1 4      2 5      2 6      3 7      3 </pre>                                                       |
| <b>DSCP-Queue Mapping</b>    |                                                                                                                                                                                                                   |
| Format                       | <pre> Switch(config)# qos dscp-map   PRIORITY Assign an priority (63 highest) Switch(config)# qos dscp-map 0   QUEUE Assign an queue (0-3) </pre> <p><b>Format: qos dscp-map priority_value queue_value</b></p>   |
| Map DSCP 0 to Queue 1        | <pre> Switch(config)# qos dscp-map 0 1 The TOS/DSCP to queue mapping is set ok. </pre>                                                                                                                            |
| Display – DSCO-Queue mapping | <pre> Switch# show qos dscp-map DSCP to Queue Mapping : (dscp = d1 d2)  d2  0 1 2 3 4 5 6 7 8 9 </pre>                                                                                                            |

|  |                         |
|--|-------------------------|
|  | d1                      |
|  | -----+                  |
|  | 0   1 1 1 1 1 1 1 1 0 0 |
|  | 1   0 0 0 0 0 0 0 0 0 0 |
|  | 2   0 0 0 0 1 1 1 1 1 1 |
|  | 3   1 1 2 2 2 2 2 2 2 2 |
|  | 4   2 2 2 2 2 2 2 2 3 3 |
|  | 5   3 3 3 3 3 3 3 3 3 3 |
|  | 6   3 3 3 3             |

## 4.8 Multicast Filtering

For multicast filtering, JetNet 4508 / 4508f use IGMP Snooping technology. IGMP (Internet Group Management Protocol) is an Internet Protocol that provides a way for internet device to report its multicast group membership to adjacent routers. Multicasting allows one computer on the internet to send data to a multitude of other computers that have identified themselves as being interested in receiving the originating computers data.

Multicasting is useful for such applications as updating the address books of mobile computer users in the field, sending out newsletters to a distribution list, and broadcasting streaming media to an audience that has tuned into the event by setting up multicast group membership.

In effect, IGMP Snooping manages multicast traffic by making use of switches, routers, and hosts that support IGMP. Enabling IGMP Snooping allows the ports to detect IGMP queries, report packets, and manage multicast traffic through the switch. IGMP has three fundamental types of messages, as shown below:

| Message            | Description                                                                                                                                    |
|--------------------|------------------------------------------------------------------------------------------------------------------------------------------------|
| <b>Query</b>       | A message sent from the querier (an IGMP router or a switch) which asks for a response from each host that belongs to the multicast group.     |
| <b>Report</b>      | A message sent by a host to the querier to indicate that the host wants to be or is a member of a given group indicated in the report message. |
| <b>Leave Group</b> | A message sent by a host to the querier to indicate that the host has quit as a member of a specific multicast group.                          |

You can enable **IGMP Snooping** and **IGMP Query** functions here. You will see the information of the IGMP Snooping function in this section, including different multicast groups' VID and member ports, and IP multicast addresses that range from 224.0.0.0 to 239.255.255.255.

In this section, Force filtering can determined whether the switch flooding unknown multicast or not.

Following commands are included in this group:

4.8.1 IGMP Snooping

4.8.2 IGMP Query

4.8.3 Force Filtering

### 4.8.1 IGMP Snooping

This page is to enable IGMP Snooping feature, assign IGMP Snooping for specific VLAN, and view IGMP Snooping table from dynamic learnt or static manual key-in. JetNet Managed Switch support IGMP snooping V1/V2/V3 automatically and IGMP query V1/V2.

**IGMP Snooping**, you can select **Enable** or **Disable** here. After enabling IGMP Snooping, you can then enable IGMP Snooping for specific VLAN. You can enable IGMP Snooping for some VLANs so that some of the VLANs will support IGMP Snooping and others won't.

To assign IGMP Snooping to VLAN, please select the **checkbox** of VLAN ID or select "**Select All**" checkbox for all VLANs. Then press **Enable**. In the same way, you can also **Disable** IGMP Snooping for certain VLANs.

#### IGMP Snooping

IGMP Snooping

|                                     | VID | IGMP Snooping |
|-------------------------------------|-----|---------------|
| <input checked="" type="checkbox"/> | 1   | Enabled       |
| <input checked="" type="checkbox"/> | 2   | Enabled       |
| <input type="checkbox"/>            | 3   | Disabled      |

Select All

**IGMP Snooping Table:** In the table, you can see multicast group IP address, VLAN ID it belongs to, and member ports of the multicast group. JetNet Managed Switch supports 256 multicast groups. Click on **Reload** to refresh the table.

#### IGMP Snooping Table

| IP Address      | VID | 1                        | 2                        | 3                        | 4                        | 5                        | 6                                   | 7                        | 8                        | 9                        | 10                       |
|-----------------|-----|--------------------------|--------------------------|--------------------------|--------------------------|--------------------------|-------------------------------------|--------------------------|--------------------------|--------------------------|--------------------------|
| 239.255.255.250 | 1   | <input type="checkbox"/> | <input type="checkbox"/> | <input type="checkbox"/> | <input type="checkbox"/> | <input type="checkbox"/> | <input checked="" type="checkbox"/> | <input type="checkbox"/> | <input type="checkbox"/> | <input type="checkbox"/> | <input type="checkbox"/> |
| 239.192.8.0     | 1   | <input type="checkbox"/> | <input type="checkbox"/> | <input type="checkbox"/> | <input type="checkbox"/> | <input type="checkbox"/> | <input checked="" type="checkbox"/> | <input type="checkbox"/> | <input type="checkbox"/> | <input type="checkbox"/> | <input type="checkbox"/> |

## 4.8.2 IGMP Query

### IGMP Query

IGMP Query on the Management VLAN

|                                |             |
|--------------------------------|-------------|
| Version                        | Version 1 ▼ |
| Query Interval(s)              | 125         |
| Query Maximum Response Time(s) | 10          |

This page allows users to configure **IGMP Query** feature. Since JetNet Managed Switch can only be configured by member ports of the management VLAN, IGMP Query can only be enabled on the management VLAN. If you want to run IGMP Snooping feature in several VLANs, you should notice that whether each VLAN has its own IGMP Querier first.

The IGMP querier periodically sends query packets to all end-stations on the LANs or VLANs that are connected to it. For networks with more than one IGMP querier, a switch with the lowest IP address becomes the IGMP querier.

In IGMP Query selection, you can select V1, V2 or Disable. **V1** means IGMP V1 General Query and **V2** means IGMP V2 General Query.. The query will be forwarded to all multicast groups in the VLAN. **Disable** allows you to disable IGMP Query.

**Query Interval(s):** The period of query sent by querier.

**Query Maximum Response Time:** The span querier detect to confirm there are no more directly connected group members on a LAN.

Once you finish configuring the settings, click on **Apply** to apply your configuration.

## 4.8.3 Force Filtering

### Force Filtering

Force Filtering  ▼

The Force filtering function allows the switch to filter the unknown-multicast data flow. If Force filtering is enabled, all the unknown multicast data will be



#### 4.8.4 CLI Commands of the Multicast Filtering

Command Lines of the multicast filtering configuration

| Feature                         | Command Line                                                                                                                                                                                                                                                                                                    |
|---------------------------------|-----------------------------------------------------------------------------------------------------------------------------------------------------------------------------------------------------------------------------------------------------------------------------------------------------------------|
| <b>IGMP Snooping</b>            |                                                                                                                                                                                                                                                                                                                 |
| IGMP Snooping - Global          | Switch(config)# ip igmp snooping<br>IGMP snooping is enabled globally. Please specify on which vlans IGMP snooping enables                                                                                                                                                                                      |
| IGMP Snooping - VLAN            | Switch(config)# ip igmp snooping vlan<br>VLANLIST allowed vlan list<br>all all existed vlan<br>Switch(config)# ip igmp snooping vlan 1-2<br>IGMP snooping is enabled on VLAN 1-2.                                                                                                                               |
| Disable IGMP Snooping - Global  | Switch(config)# no ip igmp snooping<br>IGMP snooping is disabled globally ok.                                                                                                                                                                                                                                   |
| Disable IGMP Snooping - VLAN    | Switch(config)# no ip igmp snooping vlan 3<br>IGMP snooping is disabled on VLAN 3.                                                                                                                                                                                                                              |
| Display – IGMP Snooping Setting | Switch# sh ip igmp<br>interface vlan1<br>enabled: Yes<br>version: IGMPv1<br>query-interval; 125s<br>query-max-response-time: 10s<br><br>Switch# sh ip igmp snooping<br>IGMP snooping is globally enabled<br>Vlan1 is IGMP snooping enabled<br>Vlan2 is IGMP snooping enabled<br>Vlan3 is IGMP snooping disabled |
| Display – IGMP Table            | Switch# sh ip igmp snooping multicast all<br>VLAN IP Address Type Ports<br>-----<br>1 239.192.8.0 IGMP fa6,<br>1 239.255.255.250 IGMP fa6,                                                                                                                                                                      |
| <b>IGMP Query</b>               |                                                                                                                                                                                                                                                                                                                 |
| IGMP Query V1                   | Switch(config)# int vlan 1 (Go to management VLAN)<br>Switch(config-if)# ip igmp v1                                                                                                                                                                                                                             |
| IGMP Query V2                   | Switch(config)# int vlan 1 (Go to management VLAN)<br>Switch(config-if)# ip igmp                                                                                                                                                                                                                                |
| IGMP Query version              | Switch(config-if)# ip igmp version 1<br>Switch(config-if)# ip igmp version 2                                                                                                                                                                                                                                    |
| Disable                         | Switch(config)# int vlan 1<br>Switch(config-if)# no ip igmp                                                                                                                                                                                                                                                     |
| Display                         | Switch# sh ip igmp<br>interface vlan1<br>enabled: Yes<br>version: IGMPv2<br>query-interval: 125s<br>query-max-response-time: 10s                                                                                                                                                                                |

|                         |                                                                                                                          |
|-------------------------|--------------------------------------------------------------------------------------------------------------------------|
|                         | <pre>Switch# show running-config .... ! interface vlan1  ip address 192.168.10.17/24  ip igmp  no shutdown ! .....</pre> |
| <b>Force filtering</b>  |                                                                                                                          |
| Enable Force filtering  | <pre>Switch(config)# mac-address-table multicast filtering Filtering unknown multicast addresses ok!</pre>               |
| Disable Force filtering | <pre>Switch(config)# no mac-address-table multicast filtering Flooding unknown multicast addresses ok!</pre>             |

## 4.9 SNMP

Simple Network Management Protocol (SNMP) is a protocol used for exchanging management information between network devices. SNMP is a member of the TCP/IP protocol suite. JetNet Managed Switch series support SNMP v1 and v2c and V3.

An SNMP managed network consists of two main components: agents and a manager. An agent is a management software module that resides in a managed switch. An agent translates the local management information from the managed device into a SNMP compatible format. The manager is the console through the network.

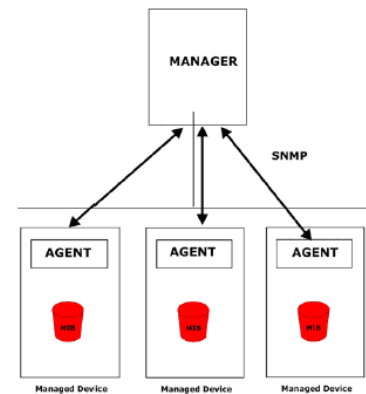

Following commands are included in this group:

### 4.9.1 SNMP Configuration

#### 4.9.2 SNMPv3 Profile

#### 4.9.3 SNMP Traps

#### 4.9.4 SNMP CLI Commands for SNMP

### 4.9.1 SNMP Configuration

This page allows users to configure SNMP V1/V2c Community. The community string can be viewed as the password because SNMP V1/V2c doesn't request you to enter password before you try to access SNMP agent.

The community includes 2 privileges, Read Only and Read and Write.

With **Read Only** privilege, you only have the ability to read the values of MIB tables. Default community string is Public.

With **Read and Write** privilege, you have the ability to read and set the values of MIB tables. Default community string is Private.

JetNet Managed Switch allows users to assign 4 community strings. Type the community string and select the privilege. Then press **Apply**.

**Note:** When you first install the device in your network, we highly recommend you to change the community string. Since most SNMP management application uses Public and Private as their default community name, this might be the leakage of the network security.

**SNMP V1/V2c Community**

| Community String | Privilege        |
|------------------|------------------|
| public           | Read Only ▼      |
| private          | Read and Write ▼ |
|                  | Read Only ▼      |
|                  | Read Only ▼      |

Apply

**4.9.2 SNMP V3 Profile**

SNMP v3 can provide more security functions when the user performs remote management through SNMP protocol. It delivers SNMP information to the administrator with user authentication; all of data between *JetNet Managed Switch* and the administrator are encrypted to ensure secure communication.

**SNMP V3 Profile**

**SNMP V3**

|                         |                      |
|-------------------------|----------------------|
| User Name               | <input type="text"/> |
| Security Level          | Authentication ▼     |
| Authentication Portocol | SHA ▼                |
| Authentication Password | <input type="text"/> |
| DES Encryption Password | <input type="text"/> |

Add

**Security Level:** Here the user can select the following levels of security: None, User Authentication, and Authentication with privacy.

**Authentication Protocol:** Here the user can select either MD5 (Message-Digest algorithm 5) or SHA (Secure Hash Algorithm). MD5 is a widely used cryptographic hash function with a 128-bit hash value. SHA (Secure Hash Algorithm) hash functions refer to five Federal Information Processing Standard-approved algorithms for computing a condensed digital representation. *JetNet Managed Switch* provides 2 user authentication protocols in MD5 and SHA. You will need to configure SNMP v3 parameters for your SNMP viewer with the same authentication method.

**Authentication Password:** Here the user enters the SNMP v3 user authentication password.

**DES Encryption Password:** Here the user enters the password for SNMP v3 user DES Encryption.

## 4.9.3 SNMP Traps

SNMP Trap is the notification feature defined by SNMP protocol. All the SNMP management applications can understand such trap information. So you don't need to install new application to read the notification information.

This page allows users to **Enable SNMP Trap**, configure the **SNMP Trap server IP**, **Community** name, and trap **Version V1 or V2**. After configuration, you can see the change of the SNMP pre-defined standard traps and Korenix pre-defined traps. The pre-defined traps can be found in Korenix private MIB.

### SNMP Trap

SNMP Trap

Apply

### SNMP Trap Server

|           |                                                               |
|-----------|---------------------------------------------------------------|
| Server IP | <input type="text" value="192.168.10.100"/>                   |
| Community | <input type="text" value="private"/>                          |
| Version   | <input type="radio"/> V1 <input checked="" type="radio"/> V2c |

Add

### Trap Server Profile

| Server IP     | Community | Version |
|---------------|-----------|---------|
| 192.168.10.33 | public    | V1      |

Remove

Reload

## 4.9.4 CLI Commands of the SNMP

Command Lines of the SNMP configuration

| Feature               | Command Line                                                               |
|-----------------------|----------------------------------------------------------------------------|
| <b>SNMP Community</b> |                                                                            |
| Read Only Community   | Switch(config)# snmp-server community public ro<br>community string add ok |
| Read Write Community  | Switch(config)# snmp-server community private rw                           |

|                                                     |                                                                                                                                                                                                                                                                                                                                             |
|-----------------------------------------------------|---------------------------------------------------------------------------------------------------------------------------------------------------------------------------------------------------------------------------------------------------------------------------------------------------------------------------------------------|
|                                                     | community string add ok                                                                                                                                                                                                                                                                                                                     |
| <b>SNMP Trap</b>                                    |                                                                                                                                                                                                                                                                                                                                             |
| Enable Trap                                         | Switch(config)# snmp-server enable trap<br>Set SNMP trap enable ok.                                                                                                                                                                                                                                                                         |
| SNMP Trap Server IP without specific community name | Switch(config)# snmp-server host 192.168.10.33<br>SNMP trap host add OK.                                                                                                                                                                                                                                                                    |
| SNMP Trap Server IP with version 1 and community    | Switch(config)# snmp-server host 192.168.10.33 version 1 private<br>SNMP trap host add OK.<br><b>Note: private is the community name, version 1 is the SNMP version</b>                                                                                                                                                                     |
| SNMP Trap Server IP with version 2 and community    | Switch(config)# snmp-server host 192.168.10.33 version 2 private<br>SNMP trap host add OK.                                                                                                                                                                                                                                                  |
| Disable SNMP Trap                                   | Switch(config)# no snmp-server enable trap<br>Set SNMP trap disable ok.                                                                                                                                                                                                                                                                     |
| Display                                             | Switch# sh snmp-server trap<br>SNMP trap: Enabled<br>SNMP trap community: public<br><br>Switch# show running-config<br>.....<br>snmp-server community public ro<br>snmp-server community private rw<br>snmp-server enable trap<br>snmp-server host 192.168.10.33 version 2 admin<br>snmp-server host 192.168.10.33 version 1 admin<br>..... |

## 4.10 Security

JetNet 4508 V2 / 4508f V2 provides several security features for you to secure your connection. The features include Port Security and IP Security.

Following commands are included in this group:

4.10.1 Port Security

4.10.2 IP Security

4.10.3 IEEE 802.1x

4.10.4 CLI Commands of the Security

### 4.10.1 Port Security

Port Security feature allows you to stop the MAC address learning for specific port. After stopping MAC learning, only the MAC address listed in Port Security List can access the switch and transmit/receive traffic. This is a simple way to secure your network environment and not to be accessed by hackers.

This page allows you to enable Port Security and configure Port Security entry.

**Port Security State:** Change Port Security State of the port to enable first.

**Add Port Security Entry:** Select the port, and type VID and MAC address. Format of the MAC address is xxxx.xxxx.xxxx. Ex: 0012.7701.0101. Max volume of one port is 10. So the system can accept 100 Port Security MAC addresses in total.

**Port Security List:** This table shows you those enabled port security entries. You can click on **Remove** to delete the entry.

### Port Security

#### Port Security State

| Port | State   |
|------|---------|
| 1    | Disable |
| 2    | Disable |
| 3    | Disable |
| 4    | Disable |
| 5    | Disable |
| 6    | Disable |
| 7    | Disable |
| 8    | Disable |
| 9    | Disable |
| 10   | Disable |

Apply

#### Add Port Security Entry

| Port   | VID | MAC Address    |
|--------|-----|----------------|
| Port 7 | 1   | 0012.7710.0102 |

Add

#### Port Security List

All

| Port | VID | MAC Address    |
|------|-----|----------------|
| 7    | 1   | 0012.7710.0101 |
| 7    | 1   | 0012.7710.0102 |

Remove

Sample of JetNet 5010G

Once you finish configuring the settings, click on **Apply / Add** to apply your configuration.

## 4.10.2 IP Security

In IP Security section, you can set up specific IP addresses to grant authorization for management access to this JetNet via a web browser or Telnet.

**IP Security:** Select Enable and **Apply** to enable IP security function.

**Add Security IP:** You can assign specific IP addresses, and then press **Add**. Only these IP addresses can access and manage JetNet via a web browser or Telnet. Max security IP is 10.

**Security IP List:** This table shows you added security IP addresses. You can press **Remove** to delete, **Reload** to reload the table.

### IP Security

IP Security

Apply

### Add Security IP

Security IP

Add

### Security IP List

| Index | Security IP   |
|-------|---------------|
| 1     | 192.168.10.33 |

Remove

Reload

Once you finish configuring the settings, click on **Apply** to apply your configuration.



### 4.10.3 IEEE 802.1x

#### 4.10.3.1 802.1X configuration

IEEE 802.1X is the protocol that performing authentication to obtain access to IEEE 802 LANs. It is port-base network access control. With the function, JetNet 4508 V2 /4508f V2 could control which connection is available or not.

Help

Your Industrial Computing & Networking Partner

### 802.1x Port-Based Network Access Control Configuration

**System Auth Control**

**Authentication Method**

**Radius Server**

|                  |                |
|------------------|----------------|
| RADIUS Server IP | 192.168.10.100 |
| Shared Key       | radius-key     |
| Server Port      | 1812           |
| Accounting Port  | 1813           |

**Local Radius User**

| Username             | Password             | VID                  |
|----------------------|----------------------|----------------------|
| <input type="text"/> | <input type="text"/> | <input type="text"/> |

**Secondary Radius Server**

|                  |                      |
|------------------|----------------------|
| RADIUS Server IP | <input type="text"/> |
| Shared Key       | <input type="text"/> |
| Server Port      | <input type="text"/> |
| Accounting Port  | <input type="text"/> |

**Local Radius User List**

| Username | Password | VID |
|----------|----------|-----|
|          |          |     |

- System AuthControl:** To enable or disable the 802.1x authentication.
- Authentication Method:** Radius is an authentication server that provide key for authentication, with this method, user must connect switch to server. If user select Local for the authentication method, switch use the local user data base which can be create in this page for authentication.
- Radius Server IP:** The IP address of Radius server
- Shared Key:** the password for communicate between switch and Radius-Server.
- Server Port:** UDP port of Radius server.
- Accounting Port:** Port for packets that contain the information of account login or logout.
- Secondary Radius Server IP:** Secondary Radius Server could be set in case of the primary radius server down.
- 802.1X Local User:** Here User can add Account/Password for local authentication.
- 802.1X Local user List:** This is a list shows the account information, User also can remove selected account Here.

### 4.10.3.2 802.1x Port Configuration

After the configuration of Radius Server or Local user list, user also need configure the authentication mode, authentication behavior, applied VLAN for each port and permitted communication. The following information will explain the port configuration.

## 802.1x Port-Based Network Access Control Port Configuration

### 802.1x Port Configuration

| Port | Port Control     | Reauthentication | Max Request | Guest VLAN | Host Mode | Admin Control Direction |
|------|------------------|------------------|-------------|------------|-----------|-------------------------|
| 1    | Force Authorized | Disable          | 2           | 0          | Single    | Both                    |
| 2    | Force Authorized | Disable          | 2           | 0          | Single    | Both                    |
| 3    | Force Authorized | Disable          | 2           | 0          | Single    | Both                    |
| 4    | Force Authorized | Disable          | 2           | 0          | Single    | Both                    |
| 5    | Force Authorized | Disable          | 2           | 0          | Single    | Both                    |
| 6    | Force Authorized | Disable          | 2           | 0          | Single    | Both                    |

Apply

Initialize Selected

Reauthenticate Selected

### 802.1x Timeout Configuration

| Port | Re-Auth Period(s) | Quiet Period(s) | Tx Period(s) | Supplicant Timeout(s) | Server Timeout(s) |
|------|-------------------|-----------------|--------------|-----------------------|-------------------|
| 1    | 3600              | 60              | 30           | 30                    | 30                |
| 2    | 3600              | 60              | 30           | 30                    | 30                |
| 3    | 3600              | 60              | 30           | 30                    | 30                |
| 4    | 3600              | 60              | 30           | 30                    | 30                |
| 5    | 3600              | 60              | 30           | 30                    | 30                |
| 6    | 3600              | 60              | 30           | 30                    | 30                |

Apply

**Port control:** Force Authorized means this port is authorized; the data is free to in/out. Force unauthorized just opposite, the port is blocked. If users want to control this port with Radius Server, please select Auto for port control.

**Reauthentication:** If enable this field, switch will ask client to re-authenticate. The default time interval is 3600 seconds.

**Max Request:** the maximum times that the switch allow client request.

**Guest VLAN:** 0 to 4094 is available for this field. If this field is set to 0, that means the port is blocked after authentication fail. Otherwise, the port will be set to Guest VLAN.

**Host Mode:** if there are more than one device connected to this port, set the Host Mode to single means only the first PC authenticate success can access this port. If this port is set to multi, all the devices can access this port once any one of them pass the authentication.

**Control Direction:** determined devices can end data out only or both send and receive.

**Re-Auth Period:** control the Re-authentication time interval, available number is 1~65535.

**Quiet Period:** When authentication failed, Switch will wait for a period and try to communicate with radius server again.

**Tx period:** the time interval of authentication request.

**Supplicant Timeout:** the timeout for the client authenticating

**Sever Timeout:** The timeout for server response for authenticating.

Once you finish configuring the settings, click on **Apply** to apply your configuration.

Click **Initialize Selected** to set the authorize state of selected port to initialize status.

Click **Reauthenticate Selected** to send EAP Request to supplicant to request reauthentication.

Click **Default Selected** to reset the configurable 802.1x parameters of selected port to the default values.

#### 4.10.3.3 802.1X Port Status

Here user can observe the port status for Port control status, Authorize Status, Authorized Supplicant and Oper Control Direction each port.

Your Industrial Computing & Networking Partner

#### 802.1x Port-Based Network Access Control Port Status

| Port | Port Control     | Authorize Status | Authorized Supplicant | Oper Control Direction |
|------|------------------|------------------|-----------------------|------------------------|
| 1    | Force Authorized | AUTHORIZED       | NONE                  | Both                   |
| 2    | Force Authorized | AUTHORIZED       | NONE                  | Both                   |
| 3    | Force Authorized | AUTHORIZED       | NONE                  | Both                   |
| 4    | Force Authorized | AUTHORIZED       | NONE                  | Both                   |
| 5    | Force Authorized | AUTHORIZED       | NONE                  | Both                   |
| 6    | Force Authorized | AUTHORIZED       | NONE                  | Both                   |
| 7    | Force Authorized | AUTHORIZED       | NONE                  | Both                   |

Reload

#### 4.10.4 CLI Commands of the Security

Command Lines of the Security configuration

| Feature              | Command Line                                                                                                                |
|----------------------|-----------------------------------------------------------------------------------------------------------------------------|
| <b>Port Security</b> |                                                                                                                             |
| Add MAC              | Switch(config)# mac-address-table static 0012.7701.0101 vlan 1<br>interface fa1<br>mac-address-table unicast static set ok! |

|                       |                                                                                                                                                                                                                                                                                                                                                                                |
|-----------------------|--------------------------------------------------------------------------------------------------------------------------------------------------------------------------------------------------------------------------------------------------------------------------------------------------------------------------------------------------------------------------------|
| Port Security         | Switch(config)# interface fa1<br>Switch(config-if)# switchport port-security<br>Disables new MAC addresses learning and aging activities!<br><br><b>Note: Rule: Add the static MAC, VLAN and Port binding first, then enable the port security to stop new MAC learning.</b>                                                                                                   |
| Disable Port Security | Switch(config-if)# no switchport port-security<br>Enable new MAC addresses learning and aging activities!                                                                                                                                                                                                                                                                      |
| Display               | Switch# show mac-address-table static<br>Destination Address    Address Type    Vlan<br>Destination Port<br>-----<br>0012.7701.0101            Static            1            fa1                                                                                                                                                                                              |
| <b>IP Security</b>    |                                                                                                                                                                                                                                                                                                                                                                                |
| IP Security           | Switch(config)# ip security<br>Set ip security enable ok.<br>Switch(config)# ip security host 192.168.10.33<br>Add ip security host 192.168.10.33 ok.                                                                                                                                                                                                                          |
| Display               | Switch# show ip security<br>ip security is enabled<br>ip security host:<br>192.168.10.33                                                                                                                                                                                                                                                                                       |
| <b>802.1x</b>         |                                                                                                                                                                                                                                                                                                                                                                                |
| enable<br><br>diabile | Switch(config)# dot1x system-auth-control<br>Switch(config)#<br>Switch(config)# no dot1x system-auth-control<br>Switch(config)#                                                                                                                                                                                                                                                |
| authentic-method      | Switch(config)# dot1x authentic-method<br>local    Use the local username database for authentication<br>radius   Use the Remote Authentication Dial-In User Service (RADIUS) servers for authentication<br>Switch(config)# dot1x authentic-method radius<br>Switch(config)#                                                                                                   |
| radius server-ip      | Switch(config)# dot1x radius<br>Switch(config)# dot1x radius server-ip 192.168.10.120 key 1234<br><br>RADIUS Server Port number NOT given. (default=1812)<br>RADIUS Accounting Port number NOT given. (default=1813)<br>RADIUS Server IP    : 192.168.10.120<br>RADIUS Server Key    : 1234<br>RADIUS Server Port   : 1812<br>RADIUS Accounting Port : 1813<br>Switch(config)# |
| radius server-ip      | Switch(config)# dot1x radius<br>Switch(config)# dot1x radius server-ip 192.168.10.120 key 1234<br><br>RADIUS Server Port number NOT given. (default=1812)<br>RADIUS Accounting Port number NOT given. (default=1813)<br>RADIUS Server IP    : 192.168.10.120<br>RADIUS Server Key    : 1234<br>RADIUS Server Port   : 1812<br>RADIUS Accounting Port : 1813<br>Switch(config)# |

|                                          |                                                                                                                                                                                                                                                                                                                                                            |
|------------------------------------------|------------------------------------------------------------------------------------------------------------------------------------------------------------------------------------------------------------------------------------------------------------------------------------------------------------------------------------------------------------|
| radius<br>secondary-server-ip            | Switch(config)# dot1x radius secondary-server-ip<br>192.168.10.250 key 5678<br><br>Port number NOT given. (default=1812)<br>RADIUS Accounting Port number NOT given. (default=1813)<br>Secondary RADIUS Server IP : 192.168.10.250<br>Secondary RADIUS Server Key : 5678<br>Secondary RADIUS Server Port : 1812<br>Secondary RADIUS Accounting Port : 1813 |
| User name/password<br>for authentication | Switch(config)# dot1x username korenix passwd korenix vlan<br>1                                                                                                                                                                                                                                                                                            |

## 4.11 Warning

JetNet 4508 / 4508f provides several types of Warning features for you to remote monitor the status of end devices or the change of your network. The features include Fault Relay, System Log and SMTP E-mail Alert.

Following commands are included in this group:

- 4.11.1 Fault Relay
- 4.11.2 Event Selection
- 4.11.3 Syslog Configuration
- 4.11.4 SMTP Configuration
- 4.11.5 CLI Commands

### 4.11.1 Fault Relay

The Switch provides 1 alarm relay output, also known as Digital Output. The relay (DO) contact is energized from normal and will form a close circuit under system fault conditions. The fault conditions include power failure, Ethernet port link fault, Ring topology change, Ping Failure, DI state change or ping remote IP address failure.

From the firmware version 1.1a, the fault relay supports multiple event relay binding function. That means fault relay not only support one event only, it can be assigned multiple event. The condition or term described as following.

| Term              | condition                                                                                                                                  | description                                                                                                                                                                          |
|-------------------|--------------------------------------------------------------------------------------------------------------------------------------------|--------------------------------------------------------------------------------------------------------------------------------------------------------------------------------------|
| <b>Power</b>      | Power DC1<br>Power DC2<br>Any                                                                                                              | Detect power input status. If one of condition occurred, relay triggered.                                                                                                            |
| <b>Port Link</b>  | Port number                                                                                                                                | Monitoring port link down event                                                                                                                                                      |
| <b>Ring</b>       | Ring failure                                                                                                                               | If ring topology changed                                                                                                                                                             |
| <b>Ping</b>       | <b>IP Address:</b> remote device's IP address.                                                                                             | If target IP does not reply ping request, then relay active.                                                                                                                         |
| <b>Ping Reset</b> | <b>IP address:</b> remote device's address<br><b>Reset Time:</b> duration of output open.<br><b>Hodl Time:</b> duration of Ping hold time. | Ping target device and trigger relay to emulate power reset for remote device, if remote system crash.<br>Note: once perform Ping reset, the relay output will form a short circuit. |
| <b>Dry Output</b> | <b>On period:</b> duration of relay output short (close).<br><b>Off period:</b> duration of relay output open.                             | Relay continuous perform On/Off behavior with different duration.                                                                                                                    |

|           |                                          |                                                  |
|-----------|------------------------------------------|--------------------------------------------------|
| <b>DI</b> | DI number<br>(JetNet 4508 supports 1 DI) | Relay trigger when DI states change to Hi or Low |
|-----------|------------------------------------------|--------------------------------------------------|

The Fault relay configuration UI has shown as below:

### Fault Relay

|                                                 |                |                                                                                                                                                                                                                                    |                 |
|-------------------------------------------------|----------------|------------------------------------------------------------------------------------------------------------------------------------------------------------------------------------------------------------------------------------|-----------------|
| <b>Relay 1</b>                                  | Status is On   |                                                                                                                                                                                                                                    |                 |
| <input type="checkbox"/> Power                  | Power ID       | Power DC1 ▼                                                                                                                                                                                                                        |                 |
| <input checked="" type="checkbox"/> * Port Link | Port           | <input type="checkbox"/> 1 <input checked="" type="checkbox"/> 2 <input type="checkbox"/> 3 <input type="checkbox"/> 4 <input type="checkbox"/> 5 <input type="checkbox"/> 6 <input type="checkbox"/> 7 <input type="checkbox"/> 8 |                 |
| <input type="checkbox"/> Ring                   | Ring Failure   |                                                                                                                                                                                                                                    |                 |
| <input type="checkbox"/> Ping                   | IP Address     | <input type="text"/>                                                                                                                                                                                                               |                 |
| <input type="checkbox"/> Ping Reset             | IP Address     | Reset Time(Sec)                                                                                                                                                                                                                    | Hold Time(Sec)  |
| <input type="checkbox"/> Dry Output             | On Period(Sec) | Off Period(Sec)                                                                                                                                                                                                                    |                 |
| <input type="checkbox"/> DI                     | DI Number      | DI 1 ▼                                                                                                                                                                                                                             | DI State High ▼ |

**Relay 1:** Show current relay state. If the relay is triggered, the event type will be marked with the symbol- \*. On the upper diagram, the replay is triggered by port event – port 2 link down.

**Power:** relay trigger by power down event. It can be set to monitoring power DC1, DC2 and both.

**Port Link:** monitoring the port link status.

**Ring:** monitoring the ring status.

**Ping:** ping predefined IP address. If the device does not reply the Ping, the relay will be triggered.

**Ping Reset:** the relay active as a power switch for remote device. If the relay alarm function is occupied for the Ping Reset, the other event should be disabled. It may cause the relay wrong action.

**IP address:** device's IP address whose power wiring is connected with relay output.

**Reset Time:** user defined duration of relay contact open to emulate power switch off. After the duration, the relay contact will change to close to emulate power switch on.

**Hold time:** user defined the booting time that device needed. After relay contact close, the Switch will start ping after count down the hold time.

**Dry Output:** forced the relay active as a on/off switch. This function also should not apply with other event.



**On period /Off period:** the duration of relay on and off. The available range of a period is 0-65535 seconds

**DI:** monitoring the Digital input state.



#### 4.11.2 Event Selection

Event Types can be divided into two basic groups: System Events and Port Events. System Events are related to the overall function of the switch, whereas Port Events related to the activity of specific ports

| <b>System Event</b>         | <b>Warning Event is sent when.....</b>                                                      |
|-----------------------------|---------------------------------------------------------------------------------------------|
| Device Cold Start           | Power is cut off and then reconnected.                                                      |
| Device Warm Start           | Reboot the device by CLI or Web UI.                                                         |
| Power 1 Failure             | Power 1 is failure.                                                                         |
| Power 2 Failure             | Power 2 is failure.                                                                         |
| Authentication failure      | An incorrect password, SNMP Community String is entered.                                    |
| Time Synchronize Failure    | Accessing to NTP Server is failure.                                                         |
| Fault Relay                 | The DO/Fault Relay is on.                                                                   |
| Super Ring Topology Changes | Master of Super Ring has changed or backup path is activated.                               |
| DI1 Change                  | The Digital Input#1 status is changed.                                                      |
| <b>Port Event</b>           | <b>Warning Event is sent when.....</b>                                                      |
| Link-Up                     | The port is connected to another device                                                     |
| Link-Down                   | The port is disconnected (e.g. the cable is pulled out, or the opposing devices turns down) |
| Both                        | The link status changed.                                                                    |

## Your Industrial Computing & Networking Partner

- Power 1 Failure
- Power 2 Failure
- Authentication Failure
- Time Synchronize Failure
- Fault Relay
- Super Ring Topology Change
- SFP DDM Failure
- DI1 Change
- DI2 Change

### Port Event Selection

| Port       | Link State                              |
|------------|-----------------------------------------|
| 1          | Disable                                 |
| 2          | Disable                                 |
| 3          | Disable                                 |
| 4          | Disable                                 |
| 5          | Disable                                 |
| 6          | Disable                                 |
| 7          | Disable                                 |
| 8          | Disable                                 |
| 9          | Disable                                 |
| 10         | Disable                                 |
| <b>App</b> | Disable<br>Link Down<br>Link Up<br>Both |

Sample of JetNet 5010G

Once you finish configuring the settings, click on **Apply** to apply your configuration.

### 4.11.3 SysLog Configuration

System Log is useful to provide system administrator locally or remotely monitor switch events history. There are 2 System Log modes provided by Switch local mode and remote mode.

**Local Mode:** In this mode, the Switch will print the occurred events selected in the Event Selection page to System Log table of JetNet Managed Switch. You can monitor the system logs in [Monitor and Diag] / [Event Log] page.

**Remote Mode:** The remote mode is also known as Server mode in JetNet series. In this mode, you should assign the IP address of the System Log server. Switch will send the occurred events selected in Event Selection page to System Log server you assigned.

**Both:** Above 2 modes can be enabled at the same time.

## Warning - SysLog Configuration

|                                                                                                      |         |
|------------------------------------------------------------------------------------------------------|---------|
| Syslog Mode                                                                                          | Both    |
| Remote IP Address                                                                                    | Disable |
| Note: When enabled Local or Remote for the system logs in the [Monitor and Diag] / [Event Log] page. |         |
| <input type="button" value="Apply"/>                                                                 |         |

Once you finish configuring the settings, click on **Apply** to apply your configuration.

**Note:** When enabling Local or Both modes, you can monitor the system logs in [Monitor and Diag] / [Event Log] page.

### 4.11.4 SMTP Configuration

The Switch supports E-mail Warning feature. The switch will send the occurred events to remote E-mail server. The receiver can then receive notification by E-mail. The E-mail warning is conformed to SMTP standard.

This page allows you to enable E-mail Alert, assign the SMTP Server IP, Sender E-mail, and Receiver E-mail. If SMTP server requests you to authorize first, you can also set up the username and password in this page.

## Warning - SMTP Configuration

**E-mail Alert**

**SMTP Configuration**

|                                         |                      |
|-----------------------------------------|----------------------|
| SMTP Server IP                          | 192.168.10.1         |
| Mail Account                            | admin@korenix.com    |
| <input type="checkbox"/> Authentication |                      |
| User Name                               |                      |
| Password                                |                      |
| Confirm Password                        |                      |
| Rcpt E-mail Address 1                   | korecare@korenix.com |
| Rcpt E-mail Address 2                   |                      |
| Rcpt E-mail Address 3                   |                      |
| Rcpt E-mail Address 4                   |                      |

| Field                                                                  | Description                                                                      |
|------------------------------------------------------------------------|----------------------------------------------------------------------------------|
| SMTP Server IP Address                                                 | Enter the IP address of the email Server                                         |
| Authentication                                                         | Click on check box to enable password                                            |
| User Name                                                              | Enter email Account name (Max.40 characters)                                     |
| Password                                                               | Enter the password of the email account                                          |
| Confirm Password                                                       | Re-type the password of the email account                                        |
| You can set up to 4 email addresses to receive email alarm from JetNet |                                                                                  |
| Rcpt E-mail Address 1                                                  | The first email address to receive email alert from JetNet (Max. 40 characters)  |
| Rcpt E-mail Address 2                                                  | The second email address to receive email alert from JetNet (Max. 40 characters) |
| Rcpt E-mail Address 3                                                  | The third email address to receive email alert from JetNet (Max. 40 characters)  |
| Rcpt E-mail Address 4                                                  | The fourth email address to receive email alert from JetNet (Max. 40 characters) |

Once you finish configuring the settings, click on **Apply** to apply your configuration.

#### 4.11.5 CLI Commands

Command Lines of the Warning configuration

| Feature             | Command Line                                                                                                                                                                                                                                           |
|---------------------|--------------------------------------------------------------------------------------------------------------------------------------------------------------------------------------------------------------------------------------------------------|
| <b>Relay Output</b> |                                                                                                                                                                                                                                                        |
| Relay Output        | <pre>Switch(config)# relay 1 di      DI state dry     dry output ping    ping failure port    port link failure power   power failure ring    super ring failure</pre> <p><b>Note: Select Relay 1 or 2 first, and then select the event types.</b></p> |
| DI State            | <pre>Switch(config)# relay 1 di &lt;1-2&gt;   DI number Switch(config)# relay 1 di 1 high    high is abnormal low     low is abnormal Switch(config)# relay 1 di 1 high</pre>                                                                          |
| Dry Output          | <pre>Switch(config)# relay 1 dry &lt;0-4294967295&gt;  turn on period in second Switch(config)# relay 1 dry 5 &lt;0-4294967295&gt;  turn off period in second</pre>                                                                                    |

|                        |                                                                                                                                                                                                                                                                                                                                                                                                                                                     |
|------------------------|-----------------------------------------------------------------------------------------------------------------------------------------------------------------------------------------------------------------------------------------------------------------------------------------------------------------------------------------------------------------------------------------------------------------------------------------------------|
|                        | Switch(config)# relay 1 dry 5 5                                                                                                                                                                                                                                                                                                                                                                                                                     |
| Ping Failure           | Switch(config)# relay 1 ping 192.168.10.33<br><cr><br>reset reset a device<br>Switch(config)# relay 1 ping 192.168.10.33 reset<br><1-65535> reset time<br>Switch(config)# relay 1 ping 192.168.10.33 reset 60<br><0-65535> hold time to retry<br>Switch(config)# relay 1 ping 192.168.10.33 reset 60 60                                                                                                                                             |
| Port Link Failure      | Switch(config)# relay 1 port<br>PORTLIST port list<br>Switch(config)# relay 1 port fa1-5                                                                                                                                                                                                                                                                                                                                                            |
| Power Failure          | Switch(config)# relay 1 power<br><1-2> power id<br>Switch(config)# relay 1 power 1<br>Switch(config)# relay 1 power 2                                                                                                                                                                                                                                                                                                                               |
| Super Ring Failure     | Switch(config)# relay 1 ring                                                                                                                                                                                                                                                                                                                                                                                                                        |
| Disable Relay          | Switch(config)# no relay<br><1-2> relay id<br>Switch(config)# no relay 1 (Relay_ID: 1 or 2)<br><cr>                                                                                                                                                                                                                                                                                                                                                 |
| Display                | Switch# show relay 1<br>Relay Output Type : Port Link<br>Port : 1, 2, 3, 4,<br>Switch# show relay 2<br>Relay Output Type : Super Ring                                                                                                                                                                                                                                                                                                               |
| <b>Event Selection</b> |                                                                                                                                                                                                                                                                                                                                                                                                                                                     |
| Event Selection        | Switch(config)# warning-event<br>coldstart Switch cold start event<br>warmstart Switch warm start event<br>linkdown Switch link down event<br>linkup Switch link up event<br>all Switch all event<br>authentication Authentication failure event<br>di Switch di event<br>fault-relay Switch fault relay event<br>power Switch power failure event<br>super-ring Switch super ring topology change event<br>time-sync Switch time synchronize event |
| Ex: Cold Start event   | Switch(config)# warning-event coldstart<br>Set cold start event enable ok.                                                                                                                                                                                                                                                                                                                                                                          |
| Ex: Link Up event      | Switch(config)# warning-event linkup<br>[IFNAME] Interface name, ex: fastethernet1 or fa8<br>Switch(config)# warning-event linkup fa5<br>Set fa5 link up event enable ok.                                                                                                                                                                                                                                                                           |
| Display                | Switch# show warning-event<br>Warning Event:<br>Cold Start: Enabled<br>Warm Start: Disabled<br>Authentication Failure: Disabled<br>Link Down: fa4-5<br>Link Up: fa4-5<br>Power Failure:<br>Super Ring Topology Change: Disabled<br>Fault Relay: Disabled<br>Time synchronize Failure: Disable                                                                                                                                                       |

|                                           |                                                                                                                                                                                                                                                                                      |
|-------------------------------------------|--------------------------------------------------------------------------------------------------------------------------------------------------------------------------------------------------------------------------------------------------------------------------------------|
|                                           | DI:DI1                                                                                                                                                                                                                                                                               |
| <b>Syslog Configuration</b>               |                                                                                                                                                                                                                                                                                      |
| Local Mode                                | Switch(config)# log syslog local                                                                                                                                                                                                                                                     |
| Server Mode                               | Switch(config)# log syslog remote 192.168.10.33                                                                                                                                                                                                                                      |
| Both                                      | Switch(config)# log syslog local<br>Switch(config)# log syslog remote 192.168.10.33                                                                                                                                                                                                  |
| Disable                                   | Switch(config)# no log syslog local                                                                                                                                                                                                                                                  |
| <b>SMTP Configuration</b>                 |                                                                                                                                                                                                                                                                                      |
| SMTP Enable                               | Switch(config)# smtp-server enable email-alert<br>SMTP Email Alert set enable ok.                                                                                                                                                                                                    |
| Sender mail                               | Switch(config)# smtp-server server 192.168.10.100<br>ACCOUNT SMTP server mail account, ex: admin@korenix.com<br>Switch(config)# smtp-server server 192.168.10.100<br>admin@korenix.com<br>SMTP Email Alert set Server: 192.168.10.100, Account:<br>admin@korenix.com ok.             |
| Receiver mail                             | Switch(config)# smtp-server receipt 1 korecare@korenix.com<br>SMTP Email Alert set receipt 1: korecare@korenix.com ok.                                                                                                                                                               |
| Authentication with username and password | Switch(config)# smtp-server authentication username admin<br>password admin<br>SMTP Email Alert set authentication Username: admin, Password:<br>admin<br><br><b>Note: You can assign string to username and password.</b>                                                           |
| Disable SMTP                              | Switch(config)# no smtp-server enable email-alert<br>SMTP Email Alert set disable ok.                                                                                                                                                                                                |
| Disable Authentication                    | Switch(config)# no smtp-server authentication<br>SMTP Email Alert set Authentication disable ok.                                                                                                                                                                                     |
| Display                                   | Switch# sh smtp-server<br>SMTP Email Alert is Enabled<br>Server: 192.168.10.100, Account: admin@korenix.com<br>Authentication: Enabled<br>Username: admin, Password: admin<br>SMTP Email Alert Receipt:<br>Receipt 1: korecare@korenix.com<br>Receipt 2:<br>Receipt 3:<br>Receipt 4: |

## 4.12 Monitor and Diag

The Switch provides several types of features for you to monitor the status of the switch or diagnostic for you to check the problem when encountering problems related to the switch. The features include MAC Address Table, Port Statistics, Port Mirror, Event Log and Ping.

Following commands are included in this group:

4.12.1 MAC Address Table

4.12.2 Port Statistics

4.12.3 Port Mirror

4.12.4 Event Log

4.12.5 Topology Discovery

4.12.5 Ping

4.12.6 CLI Commands of the Monitor and Diag

### 4.12.1 MAC Address Table

The Switch system provides 8K entries in MAC Address Table. In this page, users can change the Aging time, add Static Unicast MAC Address, monitor the MAC address or sort them by different packet types and ports. Click on **Apply** to change the value.

#### **Aging Time (Sec)**

Each switch fabric has limit size to write the learnt MAC address. To save more entries for new MAC address, the switch fabric will age out non-used MAC address entry per Aging Time timeout. The default Aging Time is 300 seconds. The Aging Time can be modified in this page.

#### **Static Unicast MAC Address**

In some applications, users may need to type in the static Unicast MAC address to its MAC address table. In this page, you can type MAC Address (format: xxxx.xxxx.xxxx), select its VID and Port ID, and then click on **Add** to add it to MAC Address table.

#### **MAC Address Table**

In this MAC Address Table, you can see all the MAC Addresses learnt by the switch fabric. The packet types include Management Unicast, Static Unicast, Dynamic Unicast, Static Multicast and Dynamic Multicast. The table allows users to sort the address by the packet types and port.

**Packet Types: Management Unicast** means MAC address of the switch. It belongs to CPU port only. **Static Unicast** MAC address can be added and deleted. **Dynamic Unicast** MAC is MAC address learnt by the switch Fabric. **Static Multicast** can be added by CLI and can be deleted by Web and CLI. **Dynamic Multicast** will appear after you enabled IGMP and the switch learnt IGMP report.

Click on **Remove** to remove the static Unicast/Multicast MAC address. Click on **Reload** to refresh the table. New learnt Unicast/Multicast MAC address will be updated to MAC address table.

## MAC Address Table

Aging Time (Sec)

Apply

### Static Unicast MAC Address

| MAC Address          | VID                  | Port     |
|----------------------|----------------------|----------|
| <input type="text"/> | <input type="text"/> | Port 1 ▾ |

Add

MAC Address Table  ▾

| MAC Address    | Address Type       | VID | 1                        | 2                        | 3                        | 4                                   | 5                        | 6                        | 7                                   | 8                        | 9                        | 10                       |
|----------------|--------------------|-----|--------------------------|--------------------------|--------------------------|-------------------------------------|--------------------------|--------------------------|-------------------------------------|--------------------------|--------------------------|--------------------------|
| 000f.b079.ca3b | Dynamic Unicast    | 1   | <input type="checkbox"/> | <input type="checkbox"/> | <input type="checkbox"/> | <input checked="" type="checkbox"/> | <input type="checkbox"/> | <input type="checkbox"/> | <input type="checkbox"/>            | <input type="checkbox"/> | <input type="checkbox"/> | <input type="checkbox"/> |
| 0012.7701.0386 | Dynamic Unicast    | 1   | <input type="checkbox"/> | <input type="checkbox"/> | <input type="checkbox"/> | <input type="checkbox"/>            | <input type="checkbox"/> | <input type="checkbox"/> | <input checked="" type="checkbox"/> | <input type="checkbox"/> | <input type="checkbox"/> | <input type="checkbox"/> |
| 0012.7710.0101 | Static Unicast     | 1   | <input type="checkbox"/> | <input type="checkbox"/> | <input type="checkbox"/> | <input type="checkbox"/>            | <input type="checkbox"/> | <input type="checkbox"/> | <input checked="" type="checkbox"/> | <input type="checkbox"/> | <input type="checkbox"/> | <input type="checkbox"/> |
| 0012.7710.0102 | Static Unicast     | 1   | <input type="checkbox"/> | <input type="checkbox"/> | <input type="checkbox"/> | <input type="checkbox"/>            | <input type="checkbox"/> | <input type="checkbox"/> | <input checked="" type="checkbox"/> | <input type="checkbox"/> | <input type="checkbox"/> | <input type="checkbox"/> |
| 0012.77ff.0100 | Management Unicast | 1   | <input type="checkbox"/> | <input type="checkbox"/> | <input type="checkbox"/> | <input type="checkbox"/>            | <input type="checkbox"/> | <input type="checkbox"/> | <input type="checkbox"/>            | <input type="checkbox"/> | <input type="checkbox"/> | <input type="checkbox"/> |
| 0100.5e40.0800 | fa6 Multicast      | 1   | <input type="checkbox"/> | <input type="checkbox"/> | <input type="checkbox"/> | <input type="checkbox"/>            | <input type="checkbox"/> | <input type="checkbox"/> | <input type="checkbox"/>            | <input type="checkbox"/> | <input type="checkbox"/> | <input type="checkbox"/> |
| 0100.5e7f.ffa  | fa4,fa6 Multicast  | 1   | <input type="checkbox"/> | <input type="checkbox"/> | <input type="checkbox"/> | <input type="checkbox"/>            | <input type="checkbox"/> | <input type="checkbox"/> | <input type="checkbox"/>            | <input type="checkbox"/> | <input type="checkbox"/> | <input type="checkbox"/> |

Remove

Reload

(Sample of JetNet 5010G )

### 4.12.2 Port Statistics

In this page, you can view operation statistics for each port. The statistics that can be viewed include Link Type, Link State, Rx Good, Rx Bad, Rx Abort, Tx Good, Tx Bad and Collision. Rx means the received packet while Tx means the transmitted packets.

*Note: If you see many Bad, Abort or Collision counts increased, that may mean your network cable is not connected well, the network performance of the port is poor...etc. Please check your network cable, Network Interface Card of the connected device, the network application, or reallocate the network traffic...etc.*

Click on **Clear Selected** to reinitialize the counts of the selected ports, and **Clear All** to reinitialize the counts of all ports. Click on **Reload** to refresh the counts.



| Port | Type   | Link | State  | Rx Good | Rx Bad | Rx Abort | Tx Good | Tx Bad | Collision |
|------|--------|------|--------|---------|--------|----------|---------|--------|-----------|
| 1    | 100TX  | Down | Enable | 0       | 0      | 0        | 0       | 0      | 0         |
| 2    | 100TX  | Down | Enable | 10      | 0      | 0        | 11      | 0      | 0         |
| 3    | 100TX  | Down | Enable | 0       | 0      | 0        | 0       | 0      | 0         |
| 4    | 100TX  | Up   | Enable | 2131    | 0      | 0        | 2452    | 0      | 0         |
| 5    | 100TX  | Down | Enable | 0       | 0      | 0        | 0       | 0      | 0         |
| 6    | 100TX  | Down | Enable | 4884    | 1      | 2        | 5919    | 0      | 0         |
| 7    | 100TX  | Up   | Enable | 54      | 0      | 0        | 2742    | 0      | 0         |
| 8    | 1000TX | Down | Enable | 0       | 0      | 0        | 0       | 0      | 0         |
| 9    | 1000TX | Down | Enable | 0       | 0      | 0        | 0       | 0      | 0         |
| 10   | 1000TX | Down | Enable | 0       | 0      | 0        | 0       | 0      | 0         |

(sample of JetNet 5010G)

### 4.12.3 Port Mirroring

Port mirroring (also called port spanning) is a tool that allows you to mirror the traffic from one or more ports onto another port, without disrupting the flow of traffic on the original port. Any traffic that goes into or out of the Source Port(s) will be duplicated at the Destination Port. This traffic can then be analyzed at the Destination port using a monitoring device or application. A network administrator will typically utilize this tool for diagnostics, debugging, or fending off attacks.

**Port Mirror Mode:** Select Enable/Disable to enable/disable Port Mirror.

**Source Port:** This is also known as Monitor Port. These are the ports you want to monitor. The traffic of all source/monitor ports will be copied to destination/analysis ports. You can choose a single port, or any combination of ports, but you can only monitor them in Rx or TX only. Click on checkbox of the Port ID, RX, Tx or Both to select the source ports.

**Destination Port:** This is also known as Analysis Port. You can analyze the traffic of all the monitored ports at this port without affecting the flow of traffic on the port(s) being monitored. Only one RX/TX of the destination port can be selected. A network administrator would typically connect a LAN analyzer or Netxray device to this port.

Once you finish configuring the settings, click on **Apply** to apply the settings.

- JetNet5010G
  - System
  - Basic Setting
  - Port Configuration
  - Network Redundancy
  - VLAN
  - Traffic Prioritization
  - Multicast Filtering
  - SNMP
  - Security
  - Warning
  - Monitor and Diag
    - MAC Address Table
    - Port Statistics
    - Port Mirroring
    - Event Log
    - Ping
  - Device Front Panel
  - Save
  - Logout

## Port Mirroring

Port Mirror Mode

### Port Selection

| Port | Source Port                         |                                     | Destination Port                 |                                  |
|------|-------------------------------------|-------------------------------------|----------------------------------|----------------------------------|
|      | Rx                                  | Tx                                  | Rx                               | Tx                               |
| 1    | <input checked="" type="checkbox"/> | <input checked="" type="checkbox"/> | <input type="radio"/>            | <input type="radio"/>            |
| 2    | <input checked="" type="checkbox"/> | <input checked="" type="checkbox"/> | <input type="radio"/>            | <input type="radio"/>            |
| 3    | <input type="checkbox"/>            | <input type="checkbox"/>            | <input checked="" type="radio"/> | <input type="radio"/>            |
| 4    | <input type="checkbox"/>            | <input type="checkbox"/>            | <input type="radio"/>            | <input checked="" type="radio"/> |
| 5    | <input type="checkbox"/>            | <input type="checkbox"/>            | <input type="radio"/>            | <input type="radio"/>            |
| 6    | <input type="checkbox"/>            | <input type="checkbox"/>            | <input type="radio"/>            | <input type="radio"/>            |
| 7    | <input type="checkbox"/>            | <input type="checkbox"/>            | <input type="radio"/>            | <input type="radio"/>            |
| 8    | <input type="checkbox"/>            | <input type="checkbox"/>            | <input type="radio"/>            | <input type="radio"/>            |
| 9    | <input type="checkbox"/>            | <input type="checkbox"/>            | <input type="radio"/>            | <input type="radio"/>            |
| 10   | <input type="checkbox"/>            | <input type="checkbox"/>            | <input type="radio"/>            | <input type="radio"/>            |

Apply

Sample of JetNet 5010G

### 4.12.4 Event Log

In the 4.10.3, we have introduced System Log feature. When System Log Local mode is selected, the Switch will record occurred events in local log table. This page shows this log table. The entry includes the index, occurred data and time and content of the events.

Click on **Clear** to clear the entries. Click on **Reload** to refresh the table.

### System Event Logs

| Index | Date  | Time     | Event Log           |
|-------|-------|----------|---------------------|
| 1     | Jan 1 | 02:50:53 | Event: Link 4 Up.   |
| 2     | Jan 1 | 02:50:51 | Event: Link 5 Down. |
| 3     | Jan 1 | 02:50:50 | Event: Link 5 Up.   |
| 4     | Jan 1 | 02:50:47 | Event: Link 4 Down. |

Clear

Reload

## 4.12.5 Topology Discovery

The JetNet Switch supports topology discovery or LLDP (IEEE 802.1AB Link Layer Discovery Protocol) function that can help user to discovery multi-vendor's network devices on same segment by NMS system which supports LLDP function, for example **Korenix JetView Pro iNMS**; With LLDP function, NMS can easier maintain the topology map, display port ID, port description, system description, VLAN ID... Once the link failure, the topology change events can be updated to the NMS as well. The LLDP Port State can display the neighbor ID and IP learnt from the connected devices.

### Topology Discovery

**LLDP** Enable ▼

**LLDP Configuration**

|                |                                                     |
|----------------|-----------------------------------------------------|
| LLDP timer     | <input style="width: 95%;" type="text" value="5"/>  |
| LLDP hold time | <input style="width: 95%;" type="text" value="10"/> |

**LLDP Port State**

| Local Port | Neighbor ID       | Neighbor IP  | Neighbor VID |   |
|------------|-------------------|--------------|--------------|---|
| fa5        | 00:12:77:ff:24:13 | 192.168.10.3 | 1            | ▲ |
| fa6        | 00:12:77:ff:24:13 | 192.168.10.3 | 1            |   |

Apply

**LLDP:** Select Enable/Disable to enable/disable LLDP function.

**LLDP Configuration:** To configure the related timer of LLDP.

**LLDP Timer:** the interval time of each LLDP and counts in second; the valid number is from 5 to 254, default is 30 seconds.

**LLDP Hold time:** The TTL (Time To Live) timer. The LLDP state will be



expired once the LLDP is not received by the hold time. The default is 120 seconds.

**Local port:** the current port number that linked with neighbor network device.

**Neighbor ID:** the MAC address of neighbor device on the same network segment.

**Neighbor IP:** the IP address of neighbor device on the same network segment.

**Neighbor VID:** the VLAN ID of neighbor device on the same network segment.

## 4.12.6 Ping Utility

This page provides **Ping Utility** for users to ping remote device and check whether the device is alive or not. Type **Target IP** address of the target device and click on **Start** to start the ping. After few seconds, you can see the result in the **Result** field.

### Ping Utility

#### Ping

Target IP

#### Result

```
PING 192.168.10.33 (192.168.10.33): 56 data bytes
64 bytes from 192.168.10.33: icmp_seq=0 ttl=128 time=0.0 ms
64 bytes from 192.168.10.33: icmp_seq=1 ttl=128 time=0.0 ms
64 bytes from 192.168.10.33: icmp_seq=2 ttl=128 time=0.0 ms
64 bytes from 192.168.10.33: icmp_seq=3 ttl=128 time=0.0 ms
64 bytes from 192.168.10.33: icmp_seq=4 ttl=128 time=0.0 ms

--- 192.168.10.33 ping statistics ---
5 packets transmitted, 5 packets received, 0% packet loss
round-trip min/avg/max = 0.0/0.0/0.0 ms
```

## 4.12.7 CLI Commands of the Monitor and Diag

Command Lines of the Monitor and Diag configuration

| Feature                            | Command Line                                                                                                                                                                                                                                    |
|------------------------------------|-------------------------------------------------------------------------------------------------------------------------------------------------------------------------------------------------------------------------------------------------|
| <b>MAC Address Table</b>           |                                                                                                                                                                                                                                                 |
| Ageing Time                        | Switch(config)# mac-address-table aging-time 350<br>mac-address-table aging-time set ok!<br><br><i>Note: 350 is the new ageing timeout value.</i>                                                                                               |
| Add Static Unicast MAC address     | Switch(config)# mac-address-table static 0012.7701.0101<br>vlan 1 interface fastethernet7<br>mac-address-table ucast static set ok!<br><br><b>Note: rule: mac-address-table static MAC_address VLAN VID interface interface_name</b>            |
| Add Multicast MAC address          | Switch(config)# mac-address-table multicast 0100.5e01.0101<br>vlan 1 interface fa6-7<br>Adds an entry in the multicast table ok!<br><br><b>Note: rule: mac-address-table multicast MAC_address VLAN VID interface_list interface_name/range</b> |
| Show MAC Address Table – All types | Switch# show mac-address-table<br><br>***** UNICAST MAC ADDRESS *****                                                                                                                                                                           |

|                                                       |                                                                                                                                                                                                                                                                                                                                                                                                                                                                                                                                                                                                                                                                                                                                    |
|-------------------------------------------------------|------------------------------------------------------------------------------------------------------------------------------------------------------------------------------------------------------------------------------------------------------------------------------------------------------------------------------------------------------------------------------------------------------------------------------------------------------------------------------------------------------------------------------------------------------------------------------------------------------------------------------------------------------------------------------------------------------------------------------------|
|                                                       | <pre> Destination Address  Address Type  Vlan  Destination Port ----- 000f.b079.ca3b      Dynamic      1      fa4 0012.7701.0386      Dynamic      1      fa7 0012.7710.0101      Static       1      fa7 0012.7710.0102      Static       1      fa7 0012.77ff.0100      Management   1 ***** MULTICAST MAC ADDRESS ***** Vlan  Mac Address  COS  Status  Ports ----- 1  0100.5e40.0800  0  fa6 1  0100.5e7f.ffa  0  fa4,fa6 </pre>                                                                                                                                                                                                                                                                                               |
| Show MAC Address Table – Dynamic Learnt MAC addresses | <pre> Switch# show mac-address-table dynamic Destination Address  Address Type  Vlan  Destination Port ----- 000f.b079.ca3b      Dynamic      1      fa4 0012.7701.0386      Dynamic      1      fa7 </pre>                                                                                                                                                                                                                                                                                                                                                                                                                                                                                                                        |
| Show MAC Address Table – Multicast MAC addresses      | <pre> Switch# show mac-address-table multicast Vlan  Mac Address  COS  Status  Ports ----- 1  0100.5e40.0800  0  fa6-7 1  0100.5e7f.ffa  0  fa4,fa6-7 </pre>                                                                                                                                                                                                                                                                                                                                                                                                                                                                                                                                                                       |
| Show MAC Address Table – Static MAC addresses         | <pre> Switch# show mac-address-table static Destination Address  Address Type  Vlan  Destination Port ----- 0012.7710.0101      Static       1      fa7 0012.7710.0102      Static       1      fa7 </pre>                                                                                                                                                                                                                                                                                                                                                                                                                                                                                                                         |
| Show Aging timeout time                               | <pre> Switch# show mac-address-table aging-time the mac-address-table aging-time is 300 sec. </pre>                                                                                                                                                                                                                                                                                                                                                                                                                                                                                                                                                                                                                                |
| <b>Port Statistics</b>                                |                                                                                                                                                                                                                                                                                                                                                                                                                                                                                                                                                                                                                                                                                                                                    |
| Port Statistics                                       | <pre> Switch# show rmon statistics fa4 (select interface) Interface fastethernet4 is enable connected, which has Inbound:   Good Octets: 178792, Bad Octets: 0   Unicast: 598, Broadcast: 1764, Multicast: 160   Pause: 0, Undersize: 0, Fragments: 0   Oversize: 0, Jabbers: 0, Disacrd: 0   Filtered: 0, RxError: 0, FCSError: 0 Outbound:   Good Octets: 330500   Unicast: 602, Broadcast: 1, Multicast: 2261   Pause: 0, Deferred: 0, Collisions: 0   SingleCollision: 0, MultipleCollision: 0   ExcessiveCollision: 0, LateCollision: 0   Filtered: 0, FCSError: 0 Number of frames received and transmitted with a length of:   64: 2388, 65to127: 142, 128to255: 11   256to511: 64, 512to1023: 10, 1024toMaxSize: 42 </pre> |
| <b>Port Mirroring</b>                                 |                                                                                                                                                                                                                                                                                                                                                                                                                                                                                                                                                                                                                                                                                                                                    |
| Enable Port Mirror                                    | <pre> Switch(config)# mirror en Mirror set enable ok. </pre>                                                                                                                                                                                                                                                                                                                                                                                                                                                                                                                                                                                                                                                                       |
| Disable Port Mirror                                   | <pre> Switch(config)# mirror disable Mirror set disable ok. </pre>                                                                                                                                                                                                                                                                                                                                                                                                                                                                                                                                                                                                                                                                 |
| Select Source Port                                    | <pre> Switch(config)# mirror source fa1-2 both Received and transmitted traffic rx Received traffic </pre>                                                                                                                                                                                                                                                                                                                                                                                                                                                                                                                                                                                                                         |

|                         |                                                                                                                                                                                                                                                                                                                                                                                                                                                                                                                                                  |
|-------------------------|--------------------------------------------------------------------------------------------------------------------------------------------------------------------------------------------------------------------------------------------------------------------------------------------------------------------------------------------------------------------------------------------------------------------------------------------------------------------------------------------------------------------------------------------------|
|                         | <pre>tx    Transmitted traffic Switch(config)# mirror source fa1-2 both Mirror source fa1-2 both set ok.</pre> <p><b>Note: Select source port list and TX/RX/Both mode.</b></p>                                                                                                                                                                                                                                                                                                                                                                  |
| Select Destination Port | <pre>Switch(config)# mirror destination fa6 both Mirror destination fa6 both set ok</pre>                                                                                                                                                                                                                                                                                                                                                                                                                                                        |
| Display                 | <pre>Switch# show mirror Mirror Status : Enabled Ingress Monitor Destination Port : fa6 Egress Monitor Destination Port : fa6 Ingress Source Ports :fa1,fa2, Egress Source Ports :fa1,fa2,</pre>                                                                                                                                                                                                                                                                                                                                                 |
| <b>Event Log</b>        |                                                                                                                                                                                                                                                                                                                                                                                                                                                                                                                                                  |
| Display                 | <pre>Switch# show event-log &lt;1&gt;Jan  1 02:50:47 snmpd[101]: Event: Link 4 Down. &lt;2&gt;Jan  1 02:50:50 snmpd[101]: Event: Link 5 Up. &lt;3&gt;Jan  1 02:50:51 snmpd[101]: Event: Link 5 Down. &lt;4&gt;Jan  1 02:50:53 snmpd[101]: Event: Link 4 Up.</pre>                                                                                                                                                                                                                                                                                |
| <b>Ping</b>             |                                                                                                                                                                                                                                                                                                                                                                                                                                                                                                                                                  |
| Ping IP                 | <pre>Switch# ping 192.168.10.33 PING 192.168.10.33 (192.168.10.33): 56 data bytes 64 bytes from 192.168.10.33: icmp_seq=0 ttl=128 time=0.0 ms 64 bytes from 192.168.10.33: icmp_seq=1 ttl=128 time=0.0 ms 64 bytes from 192.168.10.33: icmp_seq=2 ttl=128 time=0.0 ms 64 bytes from 192.168.10.33: icmp_seq=3 ttl=128 time=0.0 ms 64 bytes from 192.168.10.33: icmp_seq=4 ttl=128 time=0.0 ms  --- 192.168.10.33 ping statistics ---  5    packets transmitted, 5 packets received, 0% packet loss round-trip min/avg/max = 0.0/0.0/0.0 ms</pre> |

### 4.13 Device Front Panel

Device Front Panel command allows you to see LED status of the switch. You can see LED and link status of the Power, DO, DI, R.M. and Ports.

| Feature           | Status                                                                    |
|-------------------|---------------------------------------------------------------------------|
| Power             | On: the DC power is on applying                                           |
| Digital Output    | On: Dry Relay Output activated and the contact is formed a close circuit. |
| Digital Input     | On: Digital Input is triggered to "High" level.                           |
| R.M.(Ring Master) | Green on: Ring status normal. Yellow (Amber)on: Ring is abnormal          |
| Fast Ethernet     | Green on: Port is link up.                                                |
| Sys               | Green on: the system is ready for working.                                |

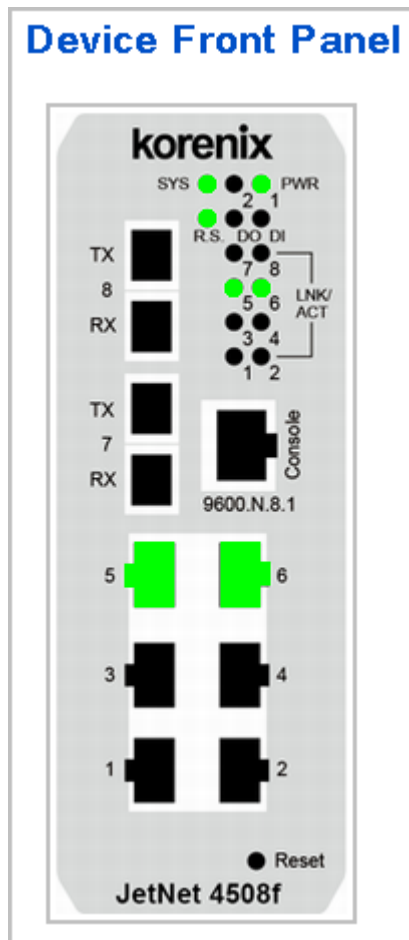

**Note: No CLI command for this feature.**



## 4.14 Save to Flash

**Save Configuration** allows you to save any configuration you just made to the Flash. Powering off the switch without clicking on **Save Configuration** will cause loss of new settings. After selecting **Save Configuration**, click on **Save to Flash** to save your new configuration.

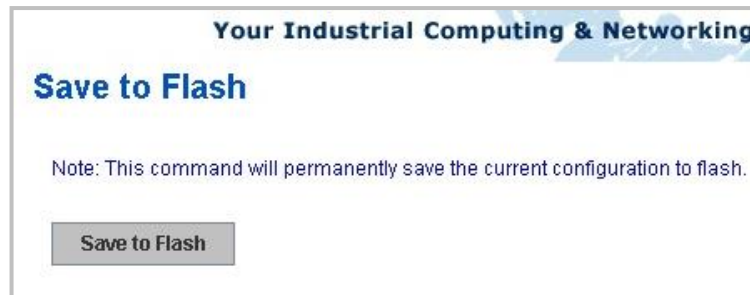

### Command Lines:

| Feature | Command Line                                                                                                                                 |
|---------|----------------------------------------------------------------------------------------------------------------------------------------------|
| Save    | <pre>SWITCH# write Building Configuration... [OK]</pre> <pre>Switch# copy running-config startup-config Building Configuration... [OK]</pre> |

## 4.15 Logout

The switch provides 2 logout methods. The web connection will be logged out if you don't input any command after 30 seconds. The Logout command allows you to manually logout the web connection. Click on **Yes** to logout, **No** to go back the configuration page.

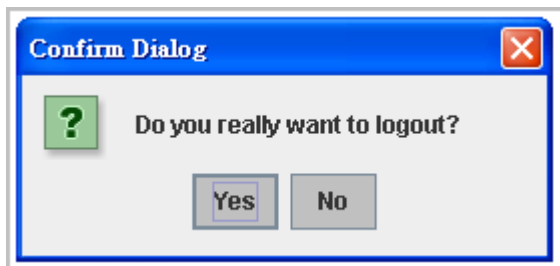

### Command Lines:

| Feature | Command Line |
|---------|--------------|
| Logout  | SWITCH> exit |
|         | SWITCH# exit |

## 5 Appendix

### 5.1 Product Specifications – JetNet 4508 /JetNet 4508f

#### Technology

|                 |                                                        |
|-----------------|--------------------------------------------------------|
| <b>Standard</b> | IEEE 802.3 10Base-T Ethernet                           |
|                 | IEEE 802.3u 100Base-TX Fast Ethernet                   |
|                 | IEEE 802.3u 100Base-FX Fast Ethernet (JetNet 4508f V2) |
|                 | IEEE 802.3x Flow Control and Back-pressure             |
|                 | IEEE 802.1AB Link Layer Discovery Protocol (LLDP)      |
|                 | IEEE 802.1p Class of Service (CoS)                     |
|                 | IEEE 802.1Q VLAN and GVRP                              |
|                 | IEEE 802.1Q-in-Q and Private VLAN                      |
|                 | IEEE 802.1D-2004 Rapid Spanning Tree Protocol (RSTP)   |
|                 | IEEE 802.1s Multiple Spanning Tree Protocol (MSTP)     |
|                 | IEEE 802.3ad Link Aggregation Protocol (LACP)          |
|                 | IEEE 802.1x Port Based Network Access Protocol         |
|                 | IEEE 1588 Precision Time Protocol (PTP)                |

#### System Performance

|                             |                                                                                                                                     |
|-----------------------------|-------------------------------------------------------------------------------------------------------------------------------------|
| <b>Switch Technology</b>    | Store and Forward Technology with 32Gbps Switch Fabric.                                                                             |
| <b>System Throughput</b>    | 26 Mega packets per second, 64 bytes packet size.<br>14,880 PPS for 10Base-T<br>148,800 PPS for 100Base-TX (PPS: Packet Per Second) |
| <b>CPU performance</b>      | 32 bits ARM-9E running at 180 MHz and performance up to 200MIPS; Embedded hardware based watchdog timer.                            |
| <b>System Memory</b>        | 8M bytes flash ROM, 64M bytes SDRAM.                                                                                                |
| <b>Transfer packet size</b> | 64 bytes to 1522bytes (includes 1522 bytes VLAN Tag).                                                                               |
| <b>MAC Address</b>          | 8K MAC address table.                                                                                                               |
| <b>Packet Buffer</b>        | 1M bits shared memory for packet buffer.                                                                                            |
| <b>Transfer performance</b> | 14,880pps for Ethernet and 148,800 for Fast Ethernet                                                                                |
| <b>Relay Alarm</b>          | Dry Relay output with 1A /24V DC ability.                                                                                           |
| <b>Digital Input (DI)</b>   | One Digital Input with Photo Copular isolation<br>Digital Hi: DC 11V~30V<br>Digital Low: DC 10V~0V                                  |

#### System Management

|                                               |                                                                                                                   |
|-----------------------------------------------|-------------------------------------------------------------------------------------------------------------------|
| <b>Configuration and monitoring interface</b> | Supports 4 configuration and monitoring interfaces: RS-232 serial console, Telnet, SNMP and Web Browser interface |
|-----------------------------------------------|-------------------------------------------------------------------------------------------------------------------|



The RS-232 and Telnet interfaces support Cisco like instructions

|                                   |                                                                                                                                 |
|-----------------------------------|---------------------------------------------------------------------------------------------------------------------------------|
| <b>System upgrade/Backup</b>      | Provides TFTP/Web interface for firmware upgrade and configuration backup, restore                                              |
| <b>Telnet &amp; Local Console</b> | Supports command line interface with Cisco like commands and maximum 4 sessions; the telnet interface also supports SSH         |
| <b>SNMP</b>                       | Supports v1, v2c, V3 with SNMP trap function, trap station up to 4 and can be manually configured the trap server IP address    |
| <b>SNMP MIB</b>                   | MIBII, Bridge MIB, Ethernet-like MIB, VLAN MIB, IGMP MIB, Korenix Private MIB                                                   |
| <b>Korenix Utility</b>            | Supports JetView and JetView Pro with IEEE 802.1AB Link Layer Discovery Protocol for device finding and link topology discovery |
| <b>Network Time Protocol</b>      | Supports NTP protocol with daylight saving function and localize time sync function.                                            |
| <b>Management IP Security</b>     | IP address security to prevent unauthorized access                                                                              |
| <b>E-mail Warning</b>             | 4 receipt E-mail accounts with mail server authentication                                                                       |
| <b>System Log</b>                 | Supports both Local or remote Server with authentication                                                                        |

## Network Performance

|                           |                                                                                                                                                                                                                                                                                                                                                     |
|---------------------------|-----------------------------------------------------------------------------------------------------------------------------------------------------------------------------------------------------------------------------------------------------------------------------------------------------------------------------------------------------|
| <b>IEEE 802.3x</b>        | Flow control pause frame supports on 10/100bps with Full Duplex and Back-pressure supports on 100 / 10Mbps Half Duplex only                                                                                                                                                                                                                         |
| <b>Port Configuration</b> | Port link Speed, Link mode, current status and enable/disable                                                                                                                                                                                                                                                                                       |
| <b>Port Trunk</b>         | IEEE 802.3ad port aggregation and static port trunk; trunk member up to 8 ports and maximum 4 trunk groups.                                                                                                                                                                                                                                         |
| <b>VLAN</b>               | IEEE 802.1Q Tag VLAN with 256 VLAN Entries and provides 2K GVRP entries<br>3 VLAN link modes- Trunk, Hybrid and Link access                                                                                                                                                                                                                         |
| <b>IEEE 802.1 Q-in-Q</b>  | Supports Double VLAN Tag function for implementing Metro Network topologies.                                                                                                                                                                                                                                                                        |
| <b>Private VLAN</b>       | The private VLAN supports isolated port access with the uplink port in the switch.<br>Typically, each private VLAN contains many private ports and one given uplink port; each private port is isolated with each other and only communicates with the uplink port for the outgoing data and incoming data to provide client port isolated feature. |
| <b>Class of Service</b>   | IEEE 802.1p class of service; per port 4 priority queues.                                                                                                                                                                                                                                                                                           |
| <b>Traffic Prioritize</b> | Supports 4 physical queues, weighted run robin queuing (WRR 8:4:2:1) and Strict Priority scheme, which follows 802.1p COS tag and IPv4 ToS/ Diffserv information to prioritize the traffic of your industrial network.                                                                                                                              |



|                                                      |                                                                                                                                                                                |
|------------------------------------------------------|--------------------------------------------------------------------------------------------------------------------------------------------------------------------------------|
| <b>IGMP Snooping</b>                                 | IGMP Snooping v1/v2 /v3 for multicast filtering and IGMP Query mode; also support unknown multicasting process forwarding policies- drop, flooding and forward to router port. |
| <b>Rate Control</b>                                  | Ingress filtering for Broadcast, Multicast, Unknown DA or all packets.<br>Egress filtering for all packet types.                                                               |
| <b>Port Mirroring</b>                                | Online traffic monitoring on multiple selected ports                                                                                                                           |
| <b>Port Security</b>                                 | Port security to assign authorized MAC to specific port                                                                                                                        |
| <b>DHCP</b>                                          | DHCP Client, DHCP Server with IP & MAC Address binding and DHCP agent (option 82).                                                                                             |
| <b>IEEE 802.1x with Radius Server Authentication</b> | Port based network access control and also supports user authenticate by the radius account, password and key for the radius server authentication.                            |

## Network Redundancy

|                                              |                                                                                                                                                                                                                |
|----------------------------------------------|----------------------------------------------------------------------------------------------------------------------------------------------------------------------------------------------------------------|
| <b>Multiple Super Ring (MSR)<sup>™</sup></b> | New generation Korenix Ring Redundancy Technology, Includes Rapid Super Ring, Rapid Dual Homing, TrunkRing <sup>™</sup> , MultiRing <sup>™</sup> and backward compatible with legacy Super Ring <sup>™</sup> . |
| <b>Rapid Dual Homing (RDH)<sup>™</sup></b>   | Multiple uplink paths to one or multiple upper switch                                                                                                                                                          |
| <b>TrunkRing<sup>™</sup></b>                 | Integrate port aggregate function in ring path to get higher throughput ring architecture                                                                                                                      |
| <b>MultiRing<sup>™</sup></b>                 | Couple or multiple up to 16 Rapid Super Rings, JetNet 4508V2 supports up to 4 Fast Ethernet Ring in one Switch.                                                                                                |
| <b>IEEE802.1d Rapid Spanning Tree</b>        | IEEE802.1D-2004 Rapid Spanning Tree Protocol. Compatible with Legacy Spanning Tree and IEEE 802.1w                                                                                                             |
| <b>IEEE802.1s Multiple Spanning Tree</b>     | Supports multiple RSTP deployed in a VLAN or multiple VLANs.<br>IEEE802.1s MSTP, each MSTP instance can include one or more VLANs.                                                                             |

## Interface

|                       |                                                                                                                                                                                                                                                               |
|-----------------------|---------------------------------------------------------------------------------------------------------------------------------------------------------------------------------------------------------------------------------------------------------------|
| <b>Enclosure Port</b> | Fast Ethernet communication port: 8 x RJ-45<br>RS-232 console interface: RJ-45 connector<br>DI/DO port: 4-pin removable terminal block<br>Power port: 4-pin removable terminal block                                                                          |
| <b>Cables</b>         | 10Base-T: 2-pairs UTP/STP Cat. 3, 4, 5 cable, EIA/TIA-568B 100-ohm (100m)<br>100 Base-TX: 2-pairs UTP/STP Cat. 5 cable, EIA/TIA-568B 100-ohm (100m)<br>JetNet 4508f –m V2: multi-mode, 50~62.5/125um, 2KM<br>JetNet 4508f-s V2: single mode, 8~10/125um, 30KM |

|                                |                                                                                                       |
|--------------------------------|-------------------------------------------------------------------------------------------------------|
| <b>Fiber port</b>              | <b>JetNet 4508f –m V2</b>                                                                             |
| <b>characteristics</b>         | Wavelength:1310nm<br>Tx power: -20dBm ~ -14dBm<br>Rx sensitivity: -31dBm ~ 0dBm<br>Link Budget: 11dB  |
|                                | <b>JetNet 4508f –s V2</b>                                                                             |
|                                | Wavelength: 1310nm<br>Tx power: -15dBm ~ -8 dBm<br>Rx sensitivity: -34dBm ~ 0 dBm<br>Link Budget:19dB |
| <b>RS-232 serial interface</b> | Supports Cisco like command line interface for out-band management                                    |

### System Diagnostic LEDs

|                      |                                                                                                                                                                                                                                                                                                                                                                                                                                                                                                  |
|----------------------|--------------------------------------------------------------------------------------------------------------------------------------------------------------------------------------------------------------------------------------------------------------------------------------------------------------------------------------------------------------------------------------------------------------------------------------------------------------------------------------------------|
| <b>System</b>        | Power status (Green): On ( power is on applying)<br>Digital Input (Green): On (Digital signal is detected)<br>Alarm Output (Red): On (Output conductor is formed as a close circuit)<br>System (Green): On (the system is ready), Blinking (system is on firmware upgrade progress)<br>Ring Status (Green/Yellow): Green on ( Ring status is normal), Green Blinking ( wrong ring port connected), Yellow on (Ring Fail is occurred), Yellow blinking (ring path broken occurred at this switch) |
| <b>Ethernet port</b> | Link (Green On) / Activity (Green Blinking)                                                                                                                                                                                                                                                                                                                                                                                                                                                      |

### Power Requirements

|                          |                                                                                                                                                        |
|--------------------------|--------------------------------------------------------------------------------------------------------------------------------------------------------|
| <b>System Power</b>      | Redundant power input with polarity auto reverse protection<br>Input Range: DC 24V (10~60V DC)<br>Power System Type: Positive or Negative power source |
| <b>Power Consumption</b> | <b>JetNet 4508-V2:</b> 9 Watts / DC 24V<br><b>JetNet 4508f-V2:</b> 10Watts / DC 24V                                                                    |

### Mechanical

|                       |                                                                                                      |
|-----------------------|------------------------------------------------------------------------------------------------------|
| <b>Installation</b>   | DIN Rail Mounting or Wall Mounting                                                                   |
| <b>Case</b>           | Aluminum metal case with grade 31 protection                                                         |
| <b>Dimension (mm)</b> | 55(W) x 149(H) x 131.2 (D) / with DIN Rail Clip<br>55(W) x 149(H) x 120.6(D) / without DIN Rail Clip |
| <b>Weight</b>         | <b>JetNet 4508V2:</b> 0.85kg<br><b>JetNet 4508f-V2:</b> 0.885Kg                                      |

### Environmental

|                              |                                                       |
|------------------------------|-------------------------------------------------------|
| <b>Operating Temperature</b> | -25~70°C ( JetNet 4508V2), -10~70°C (JetNet 4508f V2) |
|------------------------------|-------------------------------------------------------|



-40°C ~ 75 °C (JetNet 4508-w V2/JetNet 4508f-w V2)

**Operating Humidity** 0% ~ 90%, non-condensing

**Storage Temperature** -40°C ~ 85 °C

**Hi-Pot Insulation** AC 1.5KV for all ports and power

## Regulatory

### Approvals

**EMC** IEC 61000-6-2, IEC 61000-6-4, EN50121-4

#### EMI

FCC Class A, CE/ EN55022

Radiation, Conduction

#### EMS

IEC 61000-4-2, IEC 61000-4-3, IEC 61000-4-4, IEC 61000-4-5, IEC 61000-4-6, IEC 61000-4-8, IEC 61000-4-9

**Vibration** IEC60068-2-6 <sup>Note-2</sup>

**Shock** IEC60068-2-27 <sup>Note-2</sup>

**Free Fall** IEC60068-2-32 with package <sup>Note-3</sup>

**Warranty** Global 5 years

Note-2: pending

Note-3: Korenix's internal testing

Note-4: For the latest version specification, please contact your sales window or distributor.

## 5.2 Product Specifications – JetNet 4508i /JetNet 4508if

### Technology

|                 |                                                      |
|-----------------|------------------------------------------------------|
| <b>Standard</b> | IEEE 802.3 10Base-T Ethernet                         |
|                 | IEEE 802.3u 100Base-TX /100Base-FX Fast Ethernet     |
|                 | IEEE 802.3x Flow Control and Back-pressure           |
|                 | IEEE 802.1AB Link Layer Discovery Protocol (LLDP)    |
|                 | IEEE 802.1p Class of Service (CoS)                   |
|                 | IEEE 802.1Q VLAN Tag, GVRP                           |
|                 | IEEE 802.1Q-in-Q and Private VLAN                    |
|                 | IEEE 802.1D-2004 Rapid Spanning Tree Protocol (RSTP) |
|                 | IEEE 802.1s Multiple Spanning Tree Protocol (MSTP)   |
|                 | IEEE 802.3ad Link Aggregation Protocol (LACP)        |
|                 | IEEE 802.1x Port Based Network Access Protocol       |
|                 | IEEE 1588 Precision Time Protocol (PTP)              |
|                 | Modbus TCP/IP                                        |
|                 | ITU-T G.8032 ERPS                                    |

### System Performance

|                             |                                                                                                                                                                                                          |
|-----------------------------|----------------------------------------------------------------------------------------------------------------------------------------------------------------------------------------------------------|
| <b>Switch Technology</b>    | Store and Forward Technology with 32Gbps Switch Fabric.                                                                                                                                                  |
| <b>System Throughput</b>    | 26 Mega packets per second, 64 bytes packet size.<br>14,880 pps for 10Base-T<br>148,800 pps for 100Base-TX (PPS: Packet Per Second)                                                                      |
| <b>CPU performance</b>      | 32 bits ARM-9E running at 180 Mhz and performance up to 200MIPS; Embedded hardware based watch-dog timer.                                                                                                |
| <b>System Memory</b>        | 8M bytes flash ROM, 64M bytes SDRAM.                                                                                                                                                                     |
| <b>Transfer packet size</b> | 64 bytes to 1522bytes (includes 1522 bytes VLAN Tag).                                                                                                                                                    |
| <b>MAC Address</b>          | 8K MAC address table.                                                                                                                                                                                    |
| <b>Packet Buffer</b>        | 1M bits shared memory for packet buffer.                                                                                                                                                                 |
| <b>Transfer performance</b> | 14,880pps for Ethernet and 148,800 for Fast Ethernet                                                                                                                                                     |
| <b>Relay Alarm</b>          | Dry Relay output with 1A /24V DC ability. It supports multiple event reply function to alert either one of event occurred – power, port link, DI/Ring status change, Ping Reset or routing relay on/off. |
| <b>Digital Input (DI)</b>   | One Digital Input with Photo Copular isolation<br>Digital Hi: DC 11V~30V<br>Digital Low: DC 10V~0V                                                                                                       |

### System Management





|                                               |                                                                                                                                                                                       |
|-----------------------------------------------|---------------------------------------------------------------------------------------------------------------------------------------------------------------------------------------|
| <b>Configuration and monitoring interface</b> | Supports 4 configuration and monitoring interfaces: RS-232 serial console, Telnet, SNMP and Web Browser interface<br>The RS-232 and Telnet interfaces support Cisco like instructions |
| <b>System upgrade/Backup</b>                  | Provides TFTP/Web interface for firmware upgrade and configuration backup, restore                                                                                                    |
| <b>Telnet &amp; Local Console</b>             | Supports command line interface with Cisco like commands and maximum 4 sessions; the telnet interface also supports SSH                                                               |
| <b>SNMP</b>                                   | Supports v1, v2c, V3 with SNMP trap function, trap station up to 4 and can be manually configured the trap server IP address                                                          |
| <b>SNMP MIB</b>                               | MIBII, Bridge MIB, Ethernet-like MIB, VLAN MIB, IGMP MIB, Korenix Private MIB                                                                                                         |
| <b>Korenix Utility</b>                        | Supports JetView and JetView Pro with IEEE 802.1AB Link Layer Discovery Protocol for device finding and link topology discovery                                                       |
| <b>Network Time Protocol</b>                  | Supports NTP protocol with daylight saving function and localize time sync function.                                                                                                  |
| <b>Management IP Security</b>                 | IP address security to prevent unauthorized access                                                                                                                                    |
| <b>E-mail Warning</b>                         | 4 receipt E-mail accounts with mail server authentication                                                                                                                             |
| <b>System Log</b>                             | Supports both Local or remote Server with authentication                                                                                                                              |

## Network Performance

|                           |                                                                                                                                                                                                                                                                                                                                                     |
|---------------------------|-----------------------------------------------------------------------------------------------------------------------------------------------------------------------------------------------------------------------------------------------------------------------------------------------------------------------------------------------------|
| <b>IEEE 802.3x</b>        | Flow control pause frame supports on 10/100bps with Full Duplex and Back-pressure supports on 100 / 10Mbps Half Duplex only                                                                                                                                                                                                                         |
| <b>Port Configuration</b> | Port link Speed, Link mode, current status and enable/disable                                                                                                                                                                                                                                                                                       |
| <b>Port Trunk</b>         | IEEE 802.3ad port aggregation and static port trunk; trunk member up to 4 ports and maximum 4 trunk groups.                                                                                                                                                                                                                                         |
| <b>VLAN</b>               | IEEE 802.1Q Tag VLAN with 256 VLAN Entries and provides 2K GVRP entries<br>3 VLAN link modes- Trunk, Hybrid and Link access                                                                                                                                                                                                                         |
| <b>IEEE 802.1 Q-in-Q</b>  | Supports Double VLAN Tag function for implementing Metro Network topologies.                                                                                                                                                                                                                                                                        |
| <b>Private VLAN</b>       | The private VLAN supports isolated port access with the uplink port in the switch.<br>Typically, each private VLAN contains many private ports and one given uplink port; each private port is isolated with each other and only communicates with the uplink port for the outgoing data and incoming data to provide client port isolated feature. |
| <b>Class of Service</b>   | IEEE 802.1p class of service; per port 4 priority queues.                                                                                                                                                                                                                                                                                           |
| <b>Traffic Prioritize</b> | Supports 4 physical queues, weighted round robin queuing (WRR 8:4:2:1) and Strict Priority scheme, which follows 802.1p COS tag                                                                                                                                                                                                                     |

and IPv4 ToS/ Diffserv information to prioritize the traffic of your industrial network.

|                                                      |                                                                                                                                                                                |
|------------------------------------------------------|--------------------------------------------------------------------------------------------------------------------------------------------------------------------------------|
| <b>IGMP Snooping</b>                                 | IGMP Snooping v1/v2 /v3 for multicast filtering and IGMP Query mode; also support unknown multicasting process forwarding policies- drop, flooding and forward to router port. |
| <b>Rate Control</b>                                  | Ingress filtering for Broadcast, Multicast, Unknown DA or all packets.<br>Egress filtering for all packet types.                                                               |
| <b>Port Mirroring</b>                                | Online traffic monitoring on multiple selected ports                                                                                                                           |
| <b>Port Security</b>                                 | Port security to assign authorized MAC to specific port                                                                                                                        |
| <b>DHCP</b>                                          | DHCP Client, DHCP Server with IP & MAC Address binding and DHCP agent (option 82).                                                                                             |
| <b>IEEE 802.1x with Radius Server Authentication</b> | Port based network access control and also supports user authenticate by the radius account, password and key for the radius server authentication.                            |
| <b>Modbus TCP/IP</b>                                 | Support open protocol- modbus TCP/IP with function code group -4 for factory automation application.                                                                           |

## Network Redundancy

|                                              |                                                                                                                                                                                                                |
|----------------------------------------------|----------------------------------------------------------------------------------------------------------------------------------------------------------------------------------------------------------------|
| <b>Multiple Super Ring (MSR)<sup>™</sup></b> | New generation Korenix Ring Redundancy Technology, Includes Rapid Super Ring, Rapid Dual Homing, TrunkRing <sup>™</sup> , MultiRing <sup>™</sup> and backward compatible with legacy Super Ring <sup>™</sup> . |
| <b>Rapid Dual Homing (RDH)<sup>™</sup></b>   | Multiple uplink paths to one or multiple upper switch                                                                                                                                                          |
| <b>TrunkRing<sup>™</sup></b>                 | Integrate port aggregate function in ring path to get higher throughput ring architecture                                                                                                                      |
| <b>MultiRing<sup>™</sup></b>                 | Couple or multiple up to 16 Rapid Super Rings, JetNet 4508 V2 supports up to 4 Fast Ethernet Ring in one Switch.                                                                                               |
| <b>IEEE802.1d</b>                            | IEEE802.1D-2004 Rapid Spanning Tree Protocol. Compatible with                                                                                                                                                  |
| <b>Rapid Spanning Tree</b>                   | Legacy Spanning Tree and IEEE 802.1w                                                                                                                                                                           |
| <b>IEEE802.1s</b>                            | Supports multiple RSTP deployed in a VLAN or multiple VLANs.                                                                                                                                                   |
| <b>Multiple Spanning Tree</b>                | IEEE802.1s MSTP, each MSTP instance can include one or more VLANs.                                                                                                                                             |
| <b>ITU-T G.8032</b>                          | 50ms failure Recovery Time, 50ms Restoration Time                                                                                                                                                              |

## Interface

|                       |                                                                                                                                                                                                                                            |
|-----------------------|--------------------------------------------------------------------------------------------------------------------------------------------------------------------------------------------------------------------------------------------|
| <b>Enclosure Port</b> | Fast Ethernet communication port: 6 x RJ-45<br>RS-232 console interface: RJ-45 connector<br>100Mbps Fiber interface: 2 x SC or ST (by request)<br>DI/DO port: 4-pin removable terminal block<br>Power port: 4-pin removable terminal block |
|-----------------------|--------------------------------------------------------------------------------------------------------------------------------------------------------------------------------------------------------------------------------------------|

|                                   |                                                                                                                                                                                                                                                                      |
|-----------------------------------|----------------------------------------------------------------------------------------------------------------------------------------------------------------------------------------------------------------------------------------------------------------------|
| <b>Cables</b>                     | 10Base-T: 2-pairs UTP/STP Cat. 3, 4, 5 cable, EIA/TIA-568B<br>100-ohm (100m)<br>100 Base-TX: 2-pairs UTP/STP Cat. 5 cable, EIA/TIA-568B 100-ohm (100m)<br>JetNet 4508if -m: multi-mode, 50~62.5/125um, 2KM<br>JetNet 4508if -s: single mode, 8~10/125um, 30KM        |
| <b>Fiber port characteristics</b> | <b>JetNet 4508if -m</b><br>Wavelength:1310nm<br>Tx power: -20dBm ~ -10dBm<br>Rx sensitivity: -32dBm ~ -3dBm<br>Link Budget: 12dB<br><b>JetNet 4508if -s</b><br>Wavelength: 1310nm<br>Tx power: -15dBm ~ -8 dBm<br>Rx sensitivity: -34dBm ~ 0 dBm<br>Link Budget:19dB |
| <b>RS-232 serial interface</b>    | Supports Cisco like command line interface for out-band management                                                                                                                                                                                                   |

## System Diagnostic LEDs

|                           |                                                                                                                                                                                                                                                                                                                                                                                         |
|---------------------------|-----------------------------------------------------------------------------------------------------------------------------------------------------------------------------------------------------------------------------------------------------------------------------------------------------------------------------------------------------------------------------------------|
| <b>System</b>             | Power status (Green): On ( power is on applying)<br>Digital Input (Green): On (Digital signal is detected)<br>Alarm Output (Red): On (Output conductor is formed as a close circuit)<br>System (Green): On (the system is ready), Blinking (system is on firmware upgrade progress)<br>Ring Status (Green/Yellow): Green on ( Ring status is normal), Yellow on (Ring Fail is occurred) |
| <b>Fast Ethernet port</b> | Link (Green On) / Activity (Green Blinking)                                                                                                                                                                                                                                                                                                                                             |

## Power Requirements

|                          |                                                                                                                                               |
|--------------------------|-----------------------------------------------------------------------------------------------------------------------------------------------|
| <b>System Power</b>      | Isolated Redundant power input with polarity reverse protection<br>Input Range: 10.8~32V DC<br>System Type: Positive or Negative power source |
| <b>Power Consumption</b> | 15Watts / DC 24V                                                                                                                              |

## Mechanical

|                     |                                                                                                           |
|---------------------|-----------------------------------------------------------------------------------------------------------|
| <b>Installation</b> | DIN Rail Mounting or Wall Mounting                                                                        |
| <b>Case</b>         | Aluminum metal case with grade 31 protection                                                              |
| <b>Dimension</b>    | 55 (W) x 149 (H) x 131.2 (D) / with DIN Rail Clip<br>55 (W) x 149 (H) x 120.6 (D) / without DIN Rail Clip |



**Weight** 0.885kg without package

### Environmental

**Operating Temperature** -25~70°C (Jetnet 4508i), -40°C~75 °C (JetNet 4508i-w)  
-10~70°C (JetNet 4508if), -40°C~75 °C (JetNet 4508if -w)

**Operating Humidity** 0% ~ 95%, non-condensing

**Storage Temperature** -40°C ~ 85 °C

**Hi-Pot Insulation** AC 1.5KV for all ports and power

### Regulatory Approvals

**EMC** Compliance with Heavy Industrial standards- IEC 61000-6-2, IEC 61000-6-4; IEEE 61850-3 and IEEE 1613 Compliant

#### EMI

FCC Class A, CE/ EN55022

Radiation, Conduction

#### EMS

IEC 61000-4-2, IEC 61000-4-3, IEC 61000-4-4, IEC 61000-4-5, IEC 61000-4-6, IEC 61000-4-8, IEC 61000-4-9

**Vibration & Shock** IEC 60068-2-6/ IEC 60068-32

**Free Fall** IEC60068-2-32 with package

**Warranty** Global 5 years

## 5.3 Korenix Private MIB

Korenix provides many standard MIBs for users to configure or monitor the switch's configuration by SNMP. But, since some commands can't be found in standard MIB, Korenix provides Private MIB to meet up the need. Compile the private MIB file by your SNMP tool. You can then use it.

Private MIB tree is the same as the web tree. This is easier to understand and use. If you are not familiar with standard MIB, you can directly use private MIB to manage /monitor the switch, no need to learn or find where the OIDs of the commands are MIB can be found in product CD or downloaded from Korenix Web site with the latest version firmware release.

The path of the JetNet 4508f V2 is 1.3.6.1.4.1.24062.2.2.18 and JetNet 4508 V2 is 1.3.6.1.4.1.24062.2.2.17 as figures below.

|               |                                                                                                                            |
|---------------|----------------------------------------------------------------------------------------------------------------------------|
| Name:         | jetnet4508fv2                                                                                                              |
| Type:         | OBJECT-IDENTIFIER                                                                                                          |
| OID:          | 1.3.6.1.4.1.24062.2.2.18                                                                                                   |
| Full path:    | iso(1).org(3).dod(6).internet(1).private(4).enterprises(1).korenix(24062).products(2).managedFESwitch(2).jetnet4508fv2(18) |
| Module:       | Jetnet4508fv2                                                                                                              |
| Parent:       | managedFESwitch                                                                                                            |
| First child:  | systemInfo                                                                                                                 |
| Prev sibling: | jetnet4508v2                                                                                                               |
| Name:         | jetnet4508v2                                                                                                               |
| Type:         | OBJECT-IDENTIFIER                                                                                                          |
| OID:          | 1.3.6.1.4.1.24062.2.2.17                                                                                                   |
| Full path:    | iso(1).org(3).dod(6).internet(1).private(4).enterprises(1).korenix(24062).products(2).managedFESwitch(2).jetnet4508v2(17)  |
| Module:       | Jetnet4508v2                                                                                                               |
| Parent:       | managedFESwitch                                                                                                            |
| First child:  | systemInfo                                                                                                                 |
| Next sibling: | jetnet4508fv2                                                                                                              |

The JetNet 4508 / 4508f 's private MIB supports various of MIB entries, which are system basic setting, port configuration, network redundancy, VLAN, traffic priority, multicasting, snmp, security, system warning, monitoring and configuration saving. User can monitoring and configures JetNet 4508 V2/JetNet 4508f V2 by SNMP MIB browser tools and through those MIB entries to achieve remote management.

The Private MIB includes 12 major entries for system configuration and monitoring as below listing:

**System information: read only**

**Basic Setting MIB entry: read and write**

**Port Configuration MIB entry: Read and Write**

**Network redundancy MIB entry: Read and Write**

**Vlan MIB entry: Read and Write**

**Traffic prioritization MIB entry:** Read and Write

**Multicast Filtering MIB entry:** Read and Write

**SNMP MIB entry:** Read and write

**Security MIB entry:** Read and write

**Warning MIB entry:** Read and write

**Monitor and Diag:** Read and write

**Save MIB entry:** write only

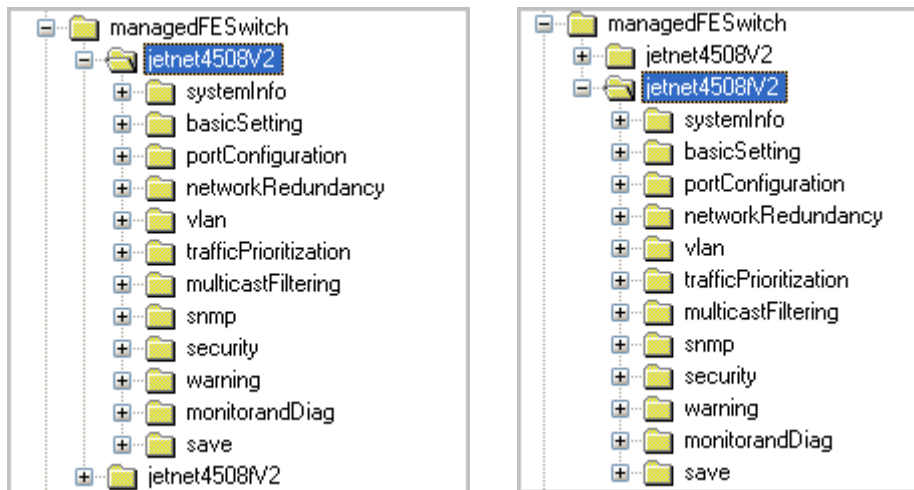

## 5.4 Modbus TCP protocol

The Modbus TCP is very similar to Modbus RTU, but transmits data within TCP/IP Data packets. It was developed in 1979 for industrial automatic communication system and have becomes a standard protocol for industrial communication for the transfer discrete analog I/O devices or PLC systems. It defines a simple protocol data unit independent of the underlying data link layer. The modbus TCP packet includes 3 parts - MBAP header, function code and data payload, the MBAP header is used on TCP/IP header to identify the Modbus application Data Unit and provides some differences compared to the MODBUS RTU application data unit used on serial line. The MBAP header also includes unit identifier to recognize and communicate between multiple independent modbus end units.

The modbus devices communicate using a master (client) /slave (server) architecture, only one device can initiate transaction and the others respond to the master/client. The other devices (slave/server) respond by supplying the requested data to the master/client, or by taking the action requested in the query. The slave/server can be any peripheral device (DSC unit, PLC unit,

Volt/Current Transducer, network communication switch) which process information and sends the output data to the master using modbus TCP protocol. Korenix JetNet Switch operating as slave/server devices, while a typical master/client device is host computer running appropriate application software, like as SCADA / HMI system. The transction architecture like as the drawing following.

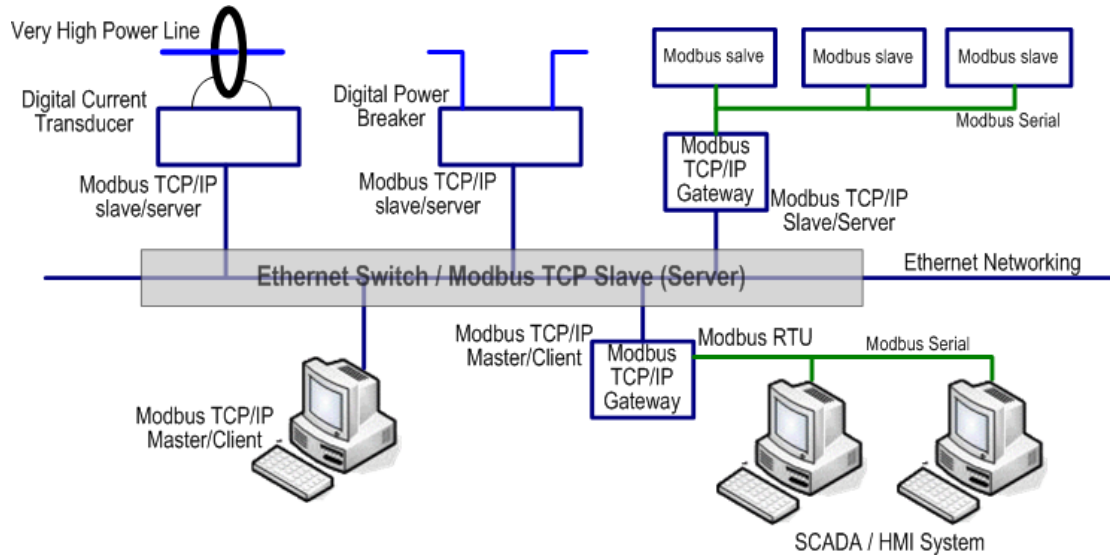

There are three most common Modbus versions, Modbus ASCII, Modbus RTU and Modbus TCP. Ethernet based device, Industrial Ethernet Switch for example, supports Modbus TCP that it can be polled through Ethernet. Thus the Modbus TCP master can read or write the Modbus registers provided by the Industrial Ethernet Switch.

The JetNet Managed DIN-Rail Ethernet Switch has implement modbus/TCP register in the firmware. Those register mapping to some of Ethernet Switches' operating information, includes decription, IP address, power status, interface status, interface information and inbound/outbound packet statistics. With the register supports, user can read the information through their own Modbus TCP based progress/ display/ monitor applications and monitor the status of the switch easily.

The configuration of Modbus/TCP only present in CLI management mode and the no extra user interface for Web configuration.

### 5.4.1 Modbus Function Code

The Modbus TCP device uses a subset of the standard Modbus TCP function code to access device-dependent information. Modbus TCP function code is defined as below.

| FC | Name | Usage |
|----|------|-------|
|----|------|-------|

|    |                       |                                                  |
|----|-----------------------|--------------------------------------------------|
| 01 | Read Coils            | Read the state of a digital output               |
| 02 | Read Input Status     | Read the state of a digital input                |
| 03 | Read Holding Register | Read holding register in 16-bits register format |
| 04 | Read Input Registers  | Read data in 16-bits register format             |
| 05 | Write Coil            | Write data to force a digital output ON/OFF      |
| 06 | Write Single Register | Write data in 16-bits register format            |
| 15 | Force Multiple Coils  | Write data to force multiple consecutive coils   |

The JetNet device supports the function code 04, which name is Read Input Registers. With this support, the remove SCADA or other Modbus TCP application can poll the information of the device and monitor the major status of the switch.

#### 5.4.2 Error Checking

The utilization of the error checking will help eliminate errors caused by noise in the communication link. In Modbus TCP mode, messages include an error-checking field that is based on a Cyclical Redundancy Check (CRC) method. The CRC filed checks the contents of the entire message. It applied regardless of any parity check method used for the individual BYTE actors of the message. The CRC value is calculated by the transmitting device, which appends the CRC to the message. The receiving device recalculates a CRC during receipt of the message, and compares the calculated value to the actual value it received in the CRC filed.

#### 5.4.3 Exception Response

If an error occurs, the slave sends an exception response message to master consisting of the slave address, function code, exception response code and error check field. In an exception response, the slave sets the high-order bit (MSB) of the response function code to one. The exception response codes are listed below.

| Code | Name                 | Descriptions                                           |
|------|----------------------|--------------------------------------------------------|
| 01   | Illegal Function     | The message function received is not allowable action. |
| 02   | Illegal Data Address | The address referenced in the data field is not valid. |



|    |                      |                                                                                                              |
|----|----------------------|--------------------------------------------------------------------------------------------------------------|
| 03 | Illegal Data Value   | The value referenced at the addressed device location is no within range.                                    |
| 04 | Slave Device Failure | An unrecoverable error occurred while the slave was attempting to perform the requested action.              |
| 05 | Acknowledge          | The slave has accepted the request and processing it, but a long duration of time will be required to do so. |
| 06 | Slave Device Busy    | The slave is engaged in processing a long-duration program command.                                          |
| 07 | Negative Acknowledge | The slave cannot perform the program function received in the query.                                         |
| 08 | Memory Parity Error  | The slave attempted to read extended memory, but detected a parity error in the memory.                      |

#### 5.4.4 Modbus TCP register table

| Word Address              | Data Type | Description                                                                                                                                                                                                                                                                  |
|---------------------------|-----------|------------------------------------------------------------------------------------------------------------------------------------------------------------------------------------------------------------------------------------------------------------------------------|
| <b>System Information</b> |           |                                                                                                                                                                                                                                                                              |
| 0x0000                    | 16 words  | Vender Name = "Korenix"<br>Word 0 Hi byte = 'K'<br>Word 0 Lo byte = 'o'<br>Word 1 Hi byte = 'r'<br>Word 1 Lo byte = 'e'<br>Word 2 Hi byte = 'n'<br>Word 2 Lo byte = 'i'<br>Word 2 Hi byte = 'x'<br>Word 2 Lo byte = '\0'<br>(other words = 0)                                |
| 0x0010                    | 16 words  | Product Name = "JetNet5828G"<br>Word 0 Hi byte = 'J'<br>Word 0 Lo byte = 'e'<br>Word 1 Hi byte = 'T'<br>Word 1 Lo byte = 'N'<br>Word 2 Hi byte = 'e'<br>Word 2 Lo byte = 't'<br>Word 3 Hi byte = '5'<br>Word 3 Lo byte = '8'<br>Word 4 Lo byte = '2'<br>Word 4 Hi byte = '8' |

|                  |           |                                                                                                                                                                                                           |
|------------------|-----------|-----------------------------------------------------------------------------------------------------------------------------------------------------------------------------------------------------------|
|                  |           | Word 5 Lo byte = 'G'<br>Word 5 Hi byte = '\0'<br>(other words = 0)                                                                                                                                        |
| 0x0020           | 128 words | SNMP system name (string)                                                                                                                                                                                 |
| 0x00A0           | 128 words | SNMP system location (string)                                                                                                                                                                             |
| 0x0120           | 128 words | SNMP system contact (string)                                                                                                                                                                              |
| 0x01A0           | 32 words  | SNMP system OID (string)                                                                                                                                                                                  |
| 0x01C0           | 2 words   | System uptime (unsigned long)                                                                                                                                                                             |
| 0x01C2 to 0x01FF | 60 words  | Reserved address space                                                                                                                                                                                    |
| 0x0200           | 2 words   | hardware version                                                                                                                                                                                          |
| 0x0202           | 2 words   | S/N information                                                                                                                                                                                           |
| 0x0204           | 2 words   | CPLD version                                                                                                                                                                                              |
| 0x0206           | 2 words   | Boot loader version                                                                                                                                                                                       |
| 0x0208           | 2 words   | Firmware Version<br>Word 0 Hi byte = major<br>Word 0 Lo byte = minor<br>Word 1 Hi byte = reserved<br>Word 1 Lo byte = reserved                                                                            |
| 0x020A           | 2 words   | Firmware Release Date<br>Firmware was released on 2010-08-11 at 09 o'clock<br>Word 0 = 0x0B09<br>Word 1 = 0x0A08                                                                                          |
| 0x020C           | 3 words   | Ethernet MAC Address<br>Ex: MAC = 01-02-03-04-05-06<br>Word 0 Hi byte = 0x01<br>Word 0 Lo byte = 0x02<br>Word 1 Hi byte = 0x03<br>Word 1 Lo byte = 0x04<br>Word 2 Hi byte = 0x05<br>Word 2 Lo byte = 0x06 |
| 0x020F to 0x2FF  | 241 words | Reserved address space                                                                                                                                                                                    |
| 0x0300           | 2 words   | IP address<br>Ex: IP = 192.168.10.1<br>Word 0 Hi byte = 0xC0<br>Word 0 Lo byte = 0xA8<br>Word 1 Hi byte = 0x0A<br>Word 1 Lo byte = 0x01                                                                   |

|                  |           |                                                       |
|------------------|-----------|-------------------------------------------------------|
| 0x0302           | 2 words   | Subnet Mask                                           |
| 0x0304           | 2 words   | Default Gateway                                       |
| 0x0306           | 2 words   | DNS Server                                            |
| 0x0308 to 0x3FF  | 248 words | Reserved address space (IPv6 or others)               |
| 0x0400           | 1 word    | AC1<br>0x0000:Off<br>0x0001:On<br>0xFFFF: unavailable |
| 0x0401           | 1 word    | AC2<br>0x0000:Off<br>0x0001:On<br>0xFFFF: unavailable |
| 0x0402           | 1 word    | DC1<br>0x0000:Off<br>0x0001:On<br>0xFFFF: unavailable |
| 0x0403           | 1 word    | DC2<br>0x0000:Off<br>0x0001:On<br>0xFFFF: unavailable |
| 0x0404 to 0x040F | 12 words  | Reserved address space                                |
| 0x0410           | 1 word    | DI1<br>0x0000:Off<br>0x0001:On<br>0xFFFF: unavailable |
| 0x0411           | 1 word    | DI2<br>0x0000:Off<br>0x0001:On<br>0xFFFF: unavailable |
| 0x0412           | 1 word    | DO1<br>0x0000:Off<br>0x0001:On<br>0xFFFF: unavailable |
| 0x0413           | 1 word    | DO2<br>0x0000:Off<br>0x0001:On<br>0xFFFF: unavailable |
| 0x0414 to 0x041F | 12 words  | Reserved address space                                |

|                                    |          |                                                                                                                                                                                            |
|------------------------------------|----------|--------------------------------------------------------------------------------------------------------------------------------------------------------------------------------------------|
| 0x0420                             | 1 word   | RDY<br>0x0000:Off<br>0x0001:On                                                                                                                                                             |
| 0x0421                             | 1 word   | RM<br>0x0000:Off<br>0x0001:On                                                                                                                                                              |
| 0x0422                             | 1 word   | RF<br>0x0000:Off<br>0x0001:On                                                                                                                                                              |
| 0x0423                             | 1 word   | RS                                                                                                                                                                                         |
| <b>Port Information (32 Ports)</b> |          |                                                                                                                                                                                            |
| 0x1000 to 0x11FF                   | 16 words | Port Description                                                                                                                                                                           |
| 0x1200 to<br>0x121F                | 1 word   | Administrative Status<br>0x0000: disable<br>0x0001: enable                                                                                                                                 |
| 0x1220 to<br>0x123F                | 1 word   | Operating Status<br>0x0000: disable<br>0x0001: enable<br>0xFFFF: unavailable                                                                                                               |
| 0x1240 to<br>0x125F                | 1 word   | Duplex<br>0x0000: half<br>0x0001: full<br>0x0003: auto (half)<br>0x0004: auto (full)<br>0x0005: auto<br>0xFFFF: unavailable                                                                |
| 0x1260 to<br>0x127F                | 1 word   | Speed<br>0x0001: 10<br>0x0002: 100<br>0x0003: 1000<br>0x0004: 2500<br>0x0005: 10000<br>0x0101: auto 10<br>0x0102: auto 100<br>0x0103: auto 1000<br>0x0104: auto 2500<br>0x0105: auto 10000 |

|                     |        |                                                                                                                   |
|---------------------|--------|-------------------------------------------------------------------------------------------------------------------|
|                     |        | 0x0100: auto<br>0xFFFF: unavailable                                                                               |
| 0x1280 to<br>0x129F | 1 word | Flow Control<br>0x0000: off<br>0x0001: on<br>0xFFFF: unavailable                                                  |
| 0x12A0 to<br>0x12BF | 1 word | Default Port VLAN ID<br>0x0001-0xFFFF                                                                             |
| 0x12C0 to<br>0x12DF | 1 word | Ingress Filtering<br>0x0000: disable<br>0x0001: enable                                                            |
| 0x12E0 to<br>0x12FF | 1 word | Acceptable Frame Type<br>0x0000: all<br>0x0001: tagged frame only                                                 |
| 0x1300 to<br>0x131F | 1 word | Port Security<br>0x0000: disable<br>0x0001: enable                                                                |
| 0x1320 to<br>0x133F | 1 word | Auto Negotiation<br>0x0000: disable<br>0x0001: enable<br>0xFFFF: unavailable                                      |
| 0x1340 to<br>0x135F | 1 word | Loopback Mode<br>0x0000: none<br>0x0001: MAC<br>0x0002: PHY<br>0xFFFF: unavailable                                |
| 0x1360 to<br>0x137F | 1 word | STP Status<br>0x0000: disabled<br>0x0001: blocking<br>0x0002: listening<br>0x0003: learning<br>0x0004: forwarding |
| 0x1380 to<br>0x139F | 1 word | Default CoS Value for untagged packets                                                                            |
| 0x13A0 to<br>0x13BF | 1 word | MDIX<br>0x0000: disable<br>0x0001: enable<br>0x0002: auto                                                         |

|                                       |            |                                                                                       |
|---------------------------------------|------------|---------------------------------------------------------------------------------------|
|                                       |            | 0xFFFF: unavailable                                                                   |
| 0x13C0 to<br>0x13DF                   | 1 word     | Medium mode<br>0x0000: copper<br>0x0001: fiber<br>0x0002: none<br>0xFFFF: unavailable |
| 0x13E0 to<br>0x14FF                   | 288 words  | Reserved address space                                                                |
| <b>SFP Information (32 Ports)</b>     |            |                                                                                       |
| 0x1500 to 0x151F                      | 1 word     | SFP Type                                                                              |
| 0x1520 to 0x153F                      | 1 words    | Wave length                                                                           |
| 0x1540 to 0x157F                      | 2 words    | Distance                                                                              |
| 0x1580 to 0x167F                      | 8 words    | Vender                                                                                |
| 0x1680 to<br>0x17FF                   | 384 words  | Reserved address space                                                                |
| <b>SFP DDM Information (32 Ports)</b> |            |                                                                                       |
| 0x1800 to 0x181F                      | 1 words    | Temperature                                                                           |
| 0x1820 to 0x185F                      | 2 words    | Alarm Temperature                                                                     |
| 0x1860 to 0x187F                      | 1 words    | Tx power                                                                              |
| 0x1880 to 0x18BF                      | 2 words    | Warning Tx power                                                                      |
| 0x18C0 to 0x18DF                      | 1 words    | Rx power                                                                              |
| 0x18E0 to 0x191F                      | 2 words    | Warning Rx power                                                                      |
| 0x1920 to<br>0x1FFF                   | 1760 words | Reserved address space                                                                |
| <b>Inbound packet information</b>     |            |                                                                                       |
| 0x2000 to<br>0x203F                   | 2 words    | Good Octets                                                                           |
| 0x2040 to<br>0x207F                   | 2 words    | Bad Octets                                                                            |
| 0x2080 to<br>0x20BF                   | 2 words    | Unicast                                                                               |
| 0x20C0 to<br>0x20FF                   | 2 words    | Broadcast                                                                             |
| 0x2100 to 0x213F                      | 2 words    | Multicast                                                                             |
| 0x2140 to<br>0x217F                   | 2 words    | Pause                                                                                 |
| 0x2180 to<br>0x21BF                   | 2 words    | Undersize                                                                             |

|                                    |           |                          |
|------------------------------------|-----------|--------------------------|
| 0x21C0 to<br>0x21FF                | 2 words   | Fragments                |
| 0x2200 to<br>0x223F                | 2 words   | Oversize                 |
| 0x2240 to<br>0x227F                | 2 words   | Jabbers                  |
| 0x2280 to<br>0x22BF                | 2 words   | Disacrds                 |
| 0x22C0 to<br>0x22FF                | 2 words   | Filtered frames          |
| 0x2300 to<br>0x233F                | 2 words   | RxError                  |
| 0x2340 to<br>0x237F                | 2 words   | FCSError                 |
| 0x2380 to 0x23BF                   | 2 words   | Collisions               |
| 0x23C0 to 0x23FF                   | 2 words   | Dropped Frames           |
| 0x2400 to 0x243F                   | 2 words   | Last Activated SysUpTime |
| 0x2440 to<br>0x24FF                | 191 words | Reserved address space   |
| <b>Outbound packet information</b> |           |                          |
| 0x2500 to<br>0x253F                | 2 words   | Good Octets              |
| 0x2540 to<br>0x257F                | 2 words   | Unicast                  |
| 0x2580 to<br>0x25BF                | 2 words   | Broadcast                |
| 0x25C0 to<br>0x25FF                | 2 words   | Multicast                |
| 0x2600 to<br>0x263F                | 2 words   | Pause                    |
| 0x2640 to<br>0x267F                | 2 words   | Deferred                 |
| 0x2680 to<br>0x26BF                | 2 words   | Collisions               |
| 0x26C0 to<br>0x26FF                | 2 words   | SingleCollision          |
| 0x2700 to<br>0x273F                | 2 words   | MultipleCollision        |

| 0x2740 to<br>0x277F                                                | 2 words   | ExcessiveCollision     |
|--------------------------------------------------------------------|-----------|------------------------|
| 0x2780 to<br>0x27BF                                                | 2 words   | LateCollision          |
| 0x27C0 to<br>0x27FF                                                | 2 words   | Filtered               |
| 0x2800 to 0x283F                                                   | 2 words   | FCSError               |
| 0x2840 to<br>0x29FF                                                | 447 words | Reserved address space |
| Number of frames received and transmitted with a length(in octets) |           |                        |
| 0x2A00 to<br>0x2A3F                                                | 2 words   | 64                     |
| 0x2A40 to<br>0x2A7F                                                | 2 words   | 65 to 127              |
| 0x2A80 to<br>0x2ABF                                                | 2 words   | 128 to 255             |
| 0x2AC0 to<br>0x2AFF                                                | 2 words   | 256 to 511             |
| 0x2B00 to<br>0x2B3F                                                | 2 words   | 512 to 1023            |
| 0x2B40 to<br>0x2B7F                                                | 2 words   | 1024 to maximum size   |

**Note: the modbus TCP client will return 0xFFFF to modbus master when pulling reserved address.**

#### 5.4.5 CLI commands for Modbus TCP

The commands of Modbus TCP are listed as following table.

| Feature                                    | Command & example                                                                                                                                                           |
|--------------------------------------------|-----------------------------------------------------------------------------------------------------------------------------------------------------------------------------|
| Enable Modbus TCP                          | Switch(config)# modbus enable                                                                                                                                               |
| Disable Modbus TCP                         | Switch(config)# modbus disable                                                                                                                                              |
| Set Modbus interval time between request   | Switch(config)# modbus idle-timeout<br><200-10000> Timeout vlaue: 200-10000ms<br>Switch(config)# modbus idle-timeout 200 → set interval request time out duration to 200ms. |
| Set modbus TCP master communicate session. | Switch(config)# modbus master<br><1-20> Max Modbus TCP Master<br>Switch(config)# modbus master 2 → set maximum                                                              |



|                               |                                                                                                                                 |
|-------------------------------|---------------------------------------------------------------------------------------------------------------------------------|
|                               | modbus master up to 2; maximum support up to 20 modbus communicate sessions.                                                    |
| Set modbus TCP listening port | Switch(config)# modbus port<br>port Listening Port<br>Switch(config)# modbus port 502 ; default modbus TCP service port is 502. |

## 5.5 Revision History

| Edition | Date        | Modifications                                                                                                                                                                                                                                                                                                                                                                                                                                                                                                                                                                                                    |
|---------|-------------|------------------------------------------------------------------------------------------------------------------------------------------------------------------------------------------------------------------------------------------------------------------------------------------------------------------------------------------------------------------------------------------------------------------------------------------------------------------------------------------------------------------------------------------------------------------------------------------------------------------|
| V01     | 12-Nov,2010 | New editing                                                                                                                                                                                                                                                                                                                                                                                                                                                                                                                                                                                                      |
| V02     | 1-DEC,2010  | Change power wiring diagram.                                                                                                                                                                                                                                                                                                                                                                                                                                                                                                                                                                                     |
| V03     | 8-DEC,2010  | Modify: <ol style="list-style-type: none"> <li>1. RS LED description</li> <li>2. Add explanation for the feature diagram of JN 5010G.</li> <li>3. update exactly model name</li> <li>4. Change the power wiring diagram with 10V dc input.</li> </ol>                                                                                                                                                                                                                                                                                                                                                            |
| V04     | 20-DEC,2010 | Change RJ-45 /DB-9 Console cable connector Pin assignment.                                                                                                                                                                                                                                                                                                                                                                                                                                                                                                                                                       |
| V1.0    | 23-Mar-2011 | Modify: <ol style="list-style-type: none"> <li>1. Add port description for port 7, 8 in the feature.</li> <li>2. Add limitation for JetNet 4508 V2: port 7, 8 support 100Mbps Auto-Negotiation only in chapter 4.3.1 Port Control , page 51.</li> </ol>                                                                                                                                                                                                                                                                                                                                                          |
| V1.1    | 22-Aug,2011 | Add new features: <ol style="list-style-type: none"> <li>1. V1.1 firmware supports multi-language function for Web User Interface. ( English, simplified Chinese)</li> <li>2. MSTP ( multiple Spanning Tree ) IEEE 802.1s</li> <li>3. Private VLAN, IEEE 802.1Q double tag VLAN</li> <li>4. Add ModBus TCP register table</li> <li>5. Add ModBus TCP CLI commands<br/>ModBus Dis/Enable, Modbus idle timeout, number of master, Modbus TCP service port.</li> <li>6. Change Daylight Saving setting method to week and monthly basis.</li> <li>7. Add Verification of Conformity cover for EN50121-4.</li> </ol> |
| V1.11   | 11-OCT-2011 | Add new cli command:<br>Daylight saving time.                                                                                                                                                                                                                                                                                                                                                                                                                                                                                                                                                                    |
| V1.12   | 29-Nov,2011 | Add multiple alarm relay function.<br>Add more Modbus TCP information: Function code, modbus introduction, etc.                                                                                                                                                                                                                                                                                                                                                                                                                                                                                                  |
| V1.13   | 13,May,2012 | Modify the descriptin of mutiple Event relay.                                                                                                                                                                                                                                                                                                                                                                                                                                                                                                                                                                    |
| V1.14   | 23,Jun,2015 | Integrated with JetNet 4508i series                                                                                                                                                                                                                                                                                                                                                                                                                                                                                                                                                                              |
|         |             |                                                                                                                                                                                                                                                                                                                                                                                                                                                                                                                                                                                                                  |



## 5.6 About Korenix

### **Less Time At Work! Fewer Budget on applications!**

The Korenix business idea is to let you spend less time at work and fewer budget on your applications. Do you really want to go through all the troubles but still end up with low quality products and lousy services? Definitely not! This is why you need Korenix. Korenix offers complete product selection that fulfills all your needs for applications. We provide easier, faster, tailor-made services, and more reliable solutions. In Korenix, there is no need to compromise. Korenix takes care of everything for you!

### **Fusion of Outstandings**

**You can end** your searching here. Korenix Technology is your one-stop supply center for industrial communications and networking products. Korenix Technology is established by a group of professionals with more than 10 year experience in the arenas of industrial control, data communications and industrial networking applications. Korenix Technology is well-positioned to fulfill your needs and demands by providing a great variety of tailor-made products and services. Korenix's industrial-grade products also come with quality services. No more searching, and no more worries. Korenix Technology stands by you all the way through.

### **Core Strength---Competitive Price and Quality**

With our work experience and in-depth know-how of industrial communications and networking, Korenix Technology is able to combine Asia's research / development ability with competitive production cost and with quality service and support.

### **Global Sales Strategy**

Korenix's global sales strategy focuses on establishing and developing trustworthy relationships with value added distributors and channel partners, and assisting OEM distributors to promote their own brands. Korenix supplies products to match local market requirements of design, quality, sales, marketing and customer services, allowing Korenix and distributors to create and enjoy profits together.

### **Quality Services**

**KoreCARE---** KoreCARE is Korenix Technology's global service center, where our professional staffs are ready to solve your problems at any time and in real-time. All of Korenix's products have passed ISO-9000/EMI/CE/FCC/UL certifications, fully satisfying your demands for product quality under critical industrial environments. Korenix global service center's e-mail is [koreCARE@korenix.com](mailto:koreCARE@korenix.com)

### **5 Years Warranty**

Each of Korenix's product line is designed, produced, and tested with high industrial standard. Korenix warrants that the Product(s) shall be free from defects in materials and workmanship for a period of five (5) years from the date of delivery provided that the Product was properly installed and used. This warranty is voided if defects, malfunctions or failures of the warranted Product are caused by damage resulting from force measure (such as floods, fire, etc.), environmental and atmospheric disturbances, other external forces such as power line disturbances, host computer malfunction, plugging the board in under power, or incorrect cabling; or the warranted Product is misused, abused, or operated, altered and repaired in an unauthorized or improper way

**Business service :** [sales@korenix.com](mailto:sales@korenix.com)

**Customer service:** [koreCARE@korenix.com](mailto:koreCARE@korenix.com)