CANopen Slave Device

CAN-2015C

Application User's Manual

Warranty

All products manufactured by ICP DAS are under warranty regarding defective materials for a period of one year from the date of delivery to the original purchaser.

Warning

ICP DAS assumes no liability for damages resulting from the use of this product. ICP DAS reserves the right to change this manual at any time without notice. The information furnished by ICP DAS is believed to be accurate and reliable. However, no responsibility is assumed by ICP DAS for its use, or for any infringements of patents or other rights of third parties resulting from its use.

Copyright

Copyright ©2012 is reserved by ICP DAS.

Trademark

The names used for identification only may be registered trademarks of their respective companies.

Table of Contents

1.	Introduction	3
1.1	Overview	3
1.2	Features	4
1.3	Hardware Specifications	4
1.4	Application	5
2.	Hardware.....	6
2.1	Structure.....	6
2.2	Node ID & Baud Rate Rotary Switch	7
2.3	LED Description.....	8
2.4	PIN Assignment	9
2.5	Wire Connection	9
3.	Application.....	10
3.1	Object Dictionary	10
3.2	Store and Restore Object.....	15
3.3	Application Object.....	16
3.4	Default PDO Mapping.....	17
3.5	EMCY Communication	18
	Appendix: Type Code Definition	19

1. Introduction

1.1 Overview

CANopen is one kind of the network protocols based on CAN bus and mainly used for embedded system, such as industrial machine control, vehicle control system, factory automation, medical equipments control, remote data acquisition, environment monitoring and package machines control. The CAN-2015C is a CANopen slave which follows the CiA 301 version 4.02 and CiA 401 version 2.1. This module provides 8 RTD input channels, and users can obtain the RTD input data or configure the CAN-2015C via the standard CANopen protocol. In order to be fully compatible with other CANopen devices, the CAN-2015C has passed the validation of the CiA CANopen Conformance Test tool. Therefore, it is very easy to integrate the CAN-2015C with the standard CANopen master by applying the EDS file. Combining with the CANopen masters of ICP DAS, you can quickly build a CANopen network to approach your requirements.

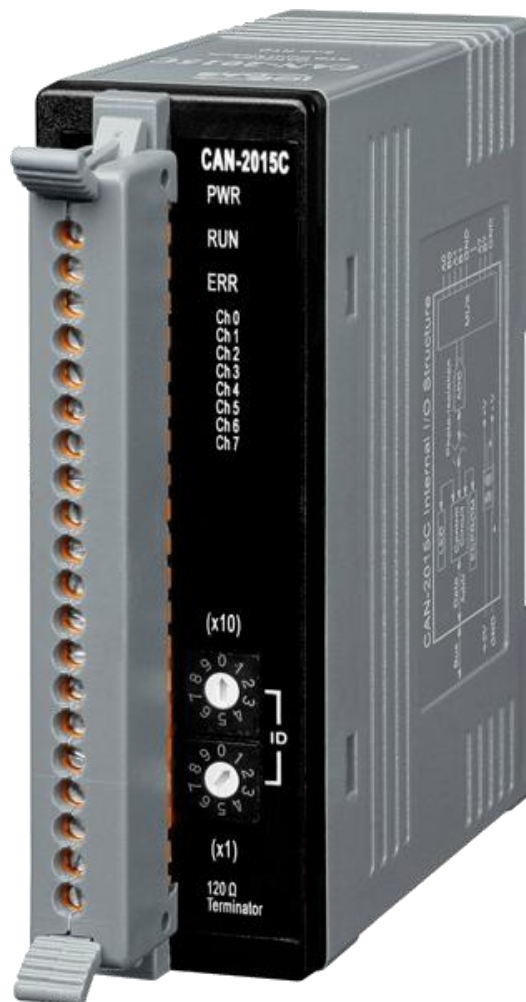

Figure 1-1 CAN-2015C

1.2 Features

- NMT Slave
- Guarding or Heartbeat Error Control protocols
- Supports Dynamic PDO
- Supports 2-wire or 3-wire RTD
- RTD broken line detection
- 10 Hz sampling rate for total channels
- Provide the EDS file
- ESD Protection 4 KV Contact for each channel
- Verifies by the CiA CANopen Conformance Test tool

1.3 Hardware Specifications

CANopen Interface	
Connector	5-pin screwed terminal block (CAN_GND, CAN_L, CAN_SHLD, CAN_H, CAN_V+)
Baud Rate (bps)	10 k, 20 k, 50 k, 125 k, 250 k, 500 k, 800 k, 1 M, selected by rotary switch
Terminator Resistor	DIP switch for the 120 Ω terminator resistor
Protocol	CANopen CiA 301 ver4.02, CiA 401 ver2.1
Node ID	1~99 selected by rotary switch
NMT	Slave
Error Control	Node Guarding protocol / Heartbeat Producer
SDOs	1 server, 0 client
PDOs	10 RxPDO, 10 TxPDO (Supports dynamic PDO)
PDO Modes	Event-triggered, remotely-requested, synchronous (cyclic), synchronous (acyclic)
Emergency Message	Yes
EDS file	Yes
Analog Input	
Channels	8 channels for 2-wire or 3-wire RTD
Input Type	Pt100, Pt1000, Ni120, Cu100, Cu1000, JPt100
Resolution	16-bit
Sampling Rate	10 Samples/Sec. (Total)
Accuracy	+/-0.05% FSR
Zero Drift	+/- 0.5 μV/ °C
Span Drift	+/- 20 ppm/ °C
Common Mode Rejection	150 dB
Normal Mode Rejection	100 dB
Individual Channel Configuration	Yes
Open Thermocouple Detection	Yes
Over voltage Protection	120 V _{DC} / 110 V _{AC}
Input Impedance	20mΩ
Isolation	3000 V DC-DC isolation, 3000 Vrms photocoupler isolation
Hardware	
ESD Protection	Contact 4 kV class A
LED	

LEDs	PWR LED, RUN LED, ERR LED, 8 LEDs for the AI high alarms or low alarms
Power	
Power Supply	Unregulated +10 ~ +30 VDC
Power Consumption	1.5 W
Mechanism	
Casing	Plastic case, fire-retardant materials (UL94-V0 Level)
Installation	DIN-Rail
Dimensions	33 mm x 99 mm x 78 mm (W x L x H)
Environment	
Operating Temp.	-25 ~ 75 °C
Storage Temp.	-30 ~ 80 °C
Humidity	10 ~ 90% RH, non-condensing

1.4 Application

- Measuring Temperature
- Medical technology
- Utility vehicles

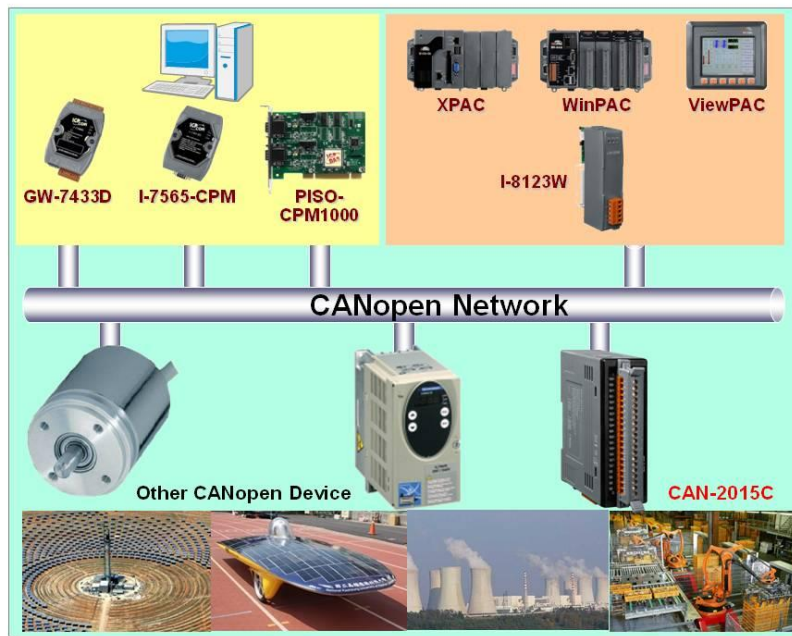

2. Hardware

2.1 Structure

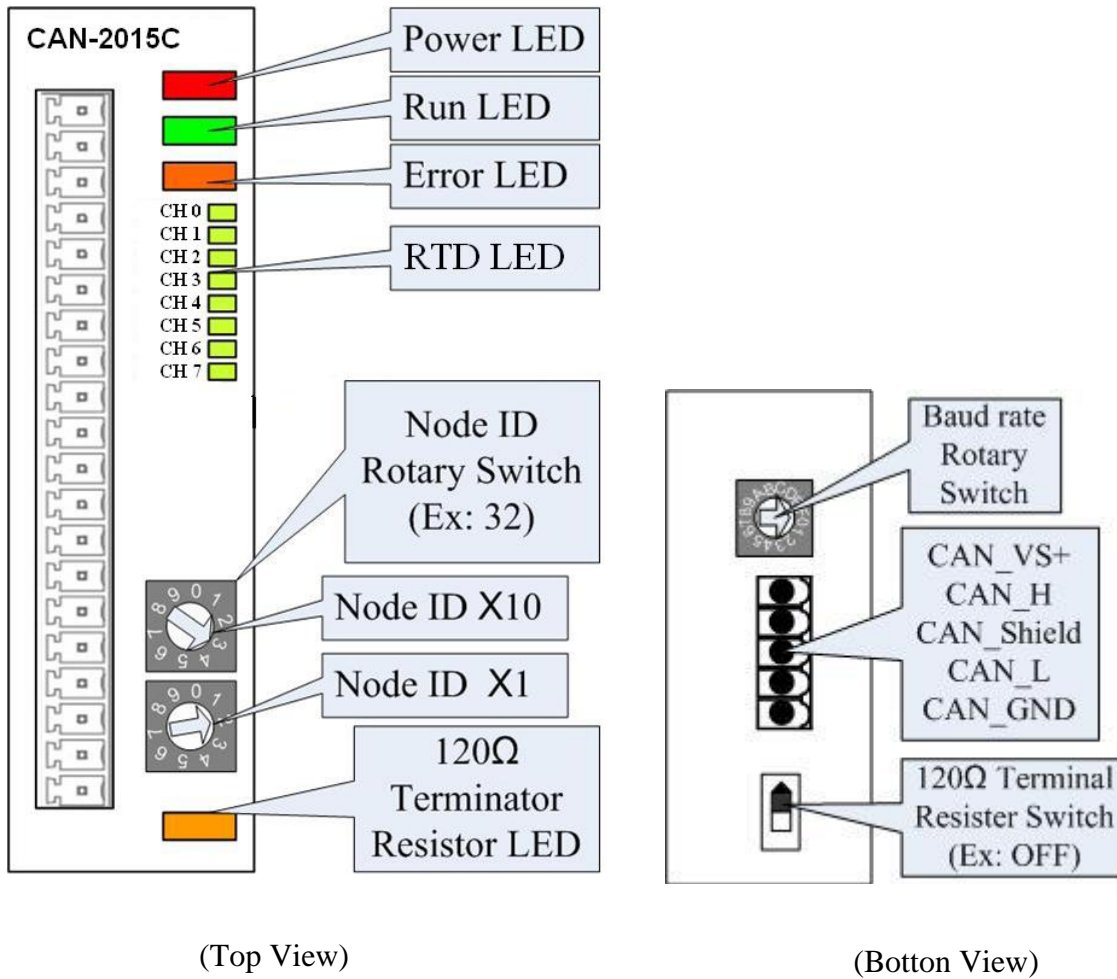

2.2 Node ID & Baud Rate Rotary Switch

The rotary switches for node ID configure the node ID of the CAN-2015C module. These two switches are for the tens digit and the units digit of node ID. The node ID value of this demo picture is 32.

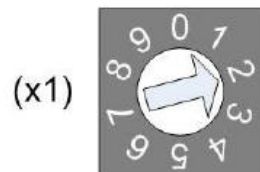
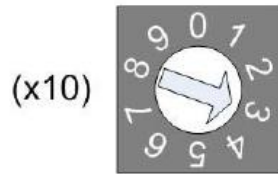

Node ID rotary switch

The rotary switch for baud rate handles the CAN baud rate of the CAN-2015C module. The relationship between the rotary switch value and the practical baud rate is presented in the following table.

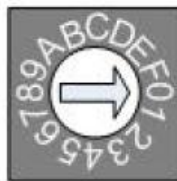

Baud rate rotary switch

Rotary Switch Value	Baud rate (k BPS)
0	10
1	20
2	50
3	125
4	250
5	500
6	800
7	1000

Baud rate and rotary switch

2.3 LED Description

Power LED

The CAN-2015C needs a 10V~30V_{DC} power supply. Under a normal connection, a good power supply and a correct voltage selection, as the unit is turned on, the LED will light up in red.

Run LED

The Run LED indicates the CANopen operation state. The description of the LED state is shown below. About the details, please refer to the section 2.3.1 of the CAN-2000C user manual.

LED Signal	State	Description
No Light	Non-power	Power Supply is not ready
Single Flash	Stopped	The device is in Stopped state
Blinking	Pre-operation	The device is in the pre-operation state
Continuing Light	Operation	The device is in the operational state

Error LED









The Error LED indicates the CANopen error state. The description of the LED state is shown below. About the details, please refer to the section 2.3.2 of the CAN-2000C user manual.

LED Signal	State	Description
No Light	Non error	Device is in working condition
Single Flash	Error Warning	At least one error of the CAN controller has occurred
Blinking	Guarding fail	Guard event happened
Continuing Light	Bus Off	The CAN controller is bus off

Terminal Resistor LED

When the switch of the 120Ω terminal resistor is turned on, the terminal resistor LED will be lightening.

2.4 PIN Assignment

Terminal No.	Pin Assignment
 01	A0
 02	B0
 03	A1
 04	B1
 05	GND
 06	A2
 07	B2
 08	A3
 09	B3
 10	GND
 11	A4
 12	B4
 13	A5
 14	B5
 15	GND
 16	A6
 17	B6
 18	A7
 19	B7
 20	GND

2.5 Wire Connection

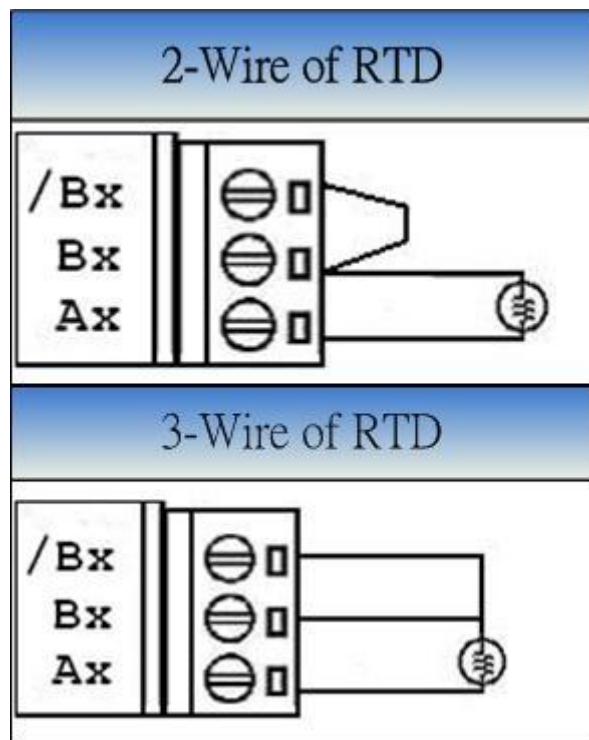

3. Application

3.1 Object Dictionary

General Communication Entries

Idx	Sidx	Description	Type	Attr	Default
1000h	0h	device type	UNSIGNED 32	RO	---
1001h	0h	error register	UNSIGNED 8	RO	---
1003h	0h	largest sub-index supported for "predefine error field"	UNSIGNED 8	RO	0h
	1h	actual error (the newest one)	UNSIGNED 32	RO	---
	---
	5h	actual error (the oldest one)	UNSIGNED 32	RO	---
1005h	0h	COB-ID of Sync message	UNSIGNED 32	RW	80h
1008h	0h	manufacturer device name	VISIBLE_STRING	RO	
1009h	0h	manufacturer hardware version	VISIBLE_STRING	RO	---
100Ah	0h	manufacturer software version	VISIBLE_STRING	RO	---
100Ch	0h	guard time	UNSIGNED 16	RW	0
100Dh	0h	life time factor	UNSIGNED 8	RW	0
1010h	0h	largest subindex supported	UNSIGNED 8	RO	1
1010h	1h	save all parameters	UNSIGNED 32	RW	0
1011h	0h	largest subindex supported	UNSIGNED 8	RO	1
1011h	1h	restore all default parameters	UNSIGNED 32	RW	0
1014h	0h	COB-ID of EMCY	UNSIGNED 32	RW	80h+Node-ID
1015h	0h	Inhibit time of EMCY	UNSIGNED 16	RW	0
1017h	0h	Heartbeat time	UNSIGNED 16	RW	0
1018h	0h	largest sub-index supported for "identity object"	UNSIGNED 8	RO	4
	1h	vender ID	UNSIGNED 32	RO	0x0000013C
	2h	Produce Code	UNSIGNED 32	RO	0x00002015
	3h	Revision_number	UNSIGNED 32	RO	0x00030001
	4h	Serial_number	UNSIGNED 32	RO	0x6cd3683c

SDO Communication Entries

Idx	Sidx	Description	Type	Attr	Default
1200h	0h	largest sub-index supported for "server SDO parameter"	UNSIGNED 8	RO	2
	1h	COB-ID form client to server (RxSDO)	UNSIGNED 32	RO	600h+Node-ID
	2h	COB-ID form server to client (TxSDO)	UNSIGNED 32	RO	580h+Node-ID

RxPDO Communication Entries

Idx	Sidx	Description	Type	Attr	Default
1400h	0h	Number of entries	UNSIGNED 8	RO	2
	1h	COB-ID used by RxPDO	UNSIGNED 32	RW	200h+Node-ID
	2h	Transmission type	UNSIGNED 8	RW	FFh
1401h	0h	Number of entries	UNSIGNED 8	RO	2
	1h	COB-ID used by RxPDO	UNSIGNED 32	RW	300h+Node-ID
	2h	Transmission type	UNSIGNED 8	RW	FFh
1402h	0h	Number of entries"	UNSIGNED 8	RO	2
	1h	COB-ID used by RxPDO	UNSIGNED 32	RW	400h+Node-ID
	2h	Transmission type	UNSIGNED 8	RW	FFh
1403h	0h	Number of entries	UNSIGNED 8	RO	2
	1h	COB-ID used by RxPDO	UNSIGNED 32	RW	500h+Node-ID
	2h	Transmission type	UNSIGNED 8	RW	FFh
1404h	0h	Number of entries	UNSIGNED 8	RO	2
	1h	COB-ID used by RxPDO	UNSIGNED 32	RW	C0000000h
	2h	Transmission type	UNSIGNED 8	RW	---
...
1409h	0h	Number of entries	UNSIGNED 8	RO	2
	1h	COB-ID used by RxPDO	UNSIGNED 32	RW	C0000000h
	2h	Transmission type	UNSIGNED 8	RW	---

RxPDO Mapping Communication Entries

Idx	Sidx	Description	Type	Attr	Default
1600h	0h	Number of entries	UNSIGNED 8	RW	0
1601h	0h	Number of entries	UNSIGNED 8	RW	0
1602h	0h	Number of entries	UNSIGNED 8	RW	0
...
1609h	0h	Number of entries	UNSIGNED 8	RW	0

TxPDO Communication Entries

Idx	Sidx	Description	Type	Attr	Default
1800h	0h	Number of entries	UNSIGNED 8	RO	5
	1h	COB-ID used by TxPDO	UNSIGNED 32	RW	180h+Node-ID
	2h	Transmission type	UNSIGNED 8	RW	FFh
	3h	Inhibit time	UNSIGNED 16	RW	0
	4h	Reversed	---	---	---
	5h	Event timer	UNSIGNED 16	RW	0
1801h	0h	Number of entries	UNSIGNED 8	RO	5
	1h	COB-ID used by TxPDO	UNSIGNED 32	RW	280h+Node-ID
	2h	Transmission type	UNSIGNED 8	RW	FFh
	3h	Inhibit time	UNSIGNED 16	RW	0
	4h	Reversed	---	---	---
	5h	Event timer	UNSIGNED 16	RW	0
1802h	0h	Number of entries	UNSIGNED 8	RO	5
	1h	COB-ID used by TxPDO	UNSIGNED 32	RW	380h+Node-ID
	2h	Transmission type	UNSIGNED 8	RW	FFh
	3h	Inhibit time	UNSIGNED 16	RW	0
	4h	Reversed	---	---	---
	5h	Event timer	UNSIGNED 16	RW	0
1803h	0h	Number of entries	UNSIGNED 8	RO	5
	1h	COB-ID used by TxPDO	UNSIGNED 32	RW	480h+Node-ID
	2h	Transmission type	UNSIGNED 8	RW	FFh
	3h	Inhibit time	UNSIGNED 16	RW	0
	4h	Reversed	---	---	---
	5h	Event timer	UNSIGNED 16	RW	0
1804h	0h	Number of entries	UNSIGNED 8	RO	5
	1h	COB-ID used by TxPDO	UNSIGNED 32	RW	80000000h
	2h	Transmission type	UNSIGNED 8	RW	FFh
	3h	Inhibit time	UNSIGNED 16	RW	0
	4h	Reversed	---	---	---
	5h	Event timer	UNSIGNED 16	RW	0
...
1809h	0h	Number of entries	UNSIGNED 8	RO	5
	1h	COB-ID used by TxPDO	UNSIGNED 32	RW	80000000h
	2h	Transmission type	UNSIGNED 8	RW	FFh
	3h	Inhibit time	UNSIGNED 16	RW	0
	4h	Reversed
	5h	Event timer	UNSIGNED 16	RW	0

TxPDO Mapping Communication Entries

Idx	Sidx	Description	Type	Attr	Default
1A00h	0h	Number of entries	UNSIGNED 8	RO	0
1A01h	0h	Number of entries	UNSIGNED 8	RO	4
	1h	RTD value of channel 0	INTEGER 32	RO	6401 0110h
	2h	RTD value of channel 1	INTEGER 32	RO	6401 0210h
	3h	RTD value of channel 2	INTEGER 32	RO	6401 0310h
	4h	RTD value of channel 3	INTEGER 32	RO	6401 0410h
1A02h	0h	Number of entries	UNSIGNED 8	RO	4
	1h	RTD value of channel 4	INTEGER 32	RO	6401 0510h
	2h	RTD value of channel 5	INTEGER 32	RO	6401 0610h
	3h	RTD value of channel 6	INTEGER 32	RO	6401 0710h
	4h	RTD value of channel 7	INTEGER 32	RO	6401 0810h
1A03h	0h	Number of entries	UNSIGNED 8	RO	0
1A04h	0h	Number of entries	UNSIGNED 8	RO	0
1A05h	0h	Number of entries	UNSIGNED 8	RO	0
...
1A09h	0h	Number of entries	UNSIGNED 8	RO	0

RTD Channel Type Code Function

Idx	Sidx	Description	Type	Attr	Default
2004h	0h	Number of entries	UNSIGNED 8	RO	8
	1h	RTD type code of channel 0	UNSIGNED 8	RW	8

	8h	RTD type code of channel 7	UNSIGNED 8	RW	8

RTD Input Function

Idx	Sidx	Description	Type	Attr	Default
6401h	0h	Number of entries	UNSIGNED 8	RO	8
	1h	The RTD value of channel 0	INTEGER16	RO	---

	8h	The RTD value of channel 7	INTEGER16	RO	---

RTD Input Global Interrupt Enable

Idx	Sidx	Description	Type	Attr	Default
6423h	0h	RTD Input Global Interrupt Trig Enable	Boolean	RW	0

RTD Input Interrupt Trigger Selection

Idx	Sidx	Description	Type	Attr	Default
6421h	0h	Number of entries	UNSIGNED 8	RO	8
	1h	RTD input interrupt trigger selection of channel 0	UNSIGNED 8	RW	7

	8h	RTD input interrupt trigger selection of channel 7	UNSIGNED 8	RW	7

Bit no.	RTD interrupt trigger selection
0	The RTD value exceeds the upper limit
1	The RTD value is less than the lower limit
2	The change of the RTD value is more than the delta
3 to 7	Reserved

RTD Input Interrupt Upper Limit Integer

Idx	Sidx	Description	Type	Attr	Default
6424h	0h	Number of entries	UNSIGNED 8	RO	8
	1h	RTD upper limit of channel 0	UNSIGNED 32	RW	---

	8h	RTD upper limit of channel 7	UNSIGNED 32	RW	---

Note: Please refer to “Appendix” for RTD upper limit range

RTD Input Interrupt Lower Limit Integer

Idx	Sidx	Description	Type	Attr	Default
6425h	0h	Number of entries	UNSIGNED 8	RO	8
	1h	RTD lower limit of channel 0	UNSIGNED 32	RW	---

	8h	RTD lower limit of channel 7	UNSIGNED 32	RW	---

Note: Please refer to “Appendix” for RTD lower limit range

RTD Input Interrupt Delta Unsigned

Idx	Sidx	Description	Type	Attr	Default
6426h	0h	Number of entries	UNSIGNED 8	RO	8
	1h	RTD delta value of channel 0	UNSIGNED 32	RW	---

	8h	RTD delta value of channel 7	UNSIGNED 32	RW	---

Note: These values are used to define the acceptable RTD change ranges for each RTD channels and may have different range for the physical value because of the settings of the type code. Please refer to the appendix or the type code definition.

3.2 Store and Restore Object

The user can write the value 65766173h to object with index 1010h and subindex 1 to save the application setting, or write the value 64616F6Ch to the object with index 1011h and subindex 1 and reboot the module to load the factory default. The following table lists the relative objects which will be stored or restored after writing these two objects. The factory default for these objects is also shown below:

Index	Subindex	Description	Factory Default
2004h	1~8	RTD type code for channel 0 ~ 7	20h
6421h	1~8	RTD interrupt trigger selections for channel 0~7	07h
6423h	1	RTD global interrupt enable	0
6424h	1~8	RTD interrupt upper limit for channel 0~7	--
6425h	1~8	RTD interrupt lower limit for channel 0~7	--
6426h	1~8	RTD interrupt delta values for channel 0~7	--
1400h	1~2	RxPDO1 parameter	--
...
1409h	1~2	RxPDO10 parameter	--
1600h	0~8	RxPDO1 mapping information	--
...
1609h	0~8	RxPDO10 mapping information	--
1800h	1~5	TxPDO1 parameter	--
...
1809h	1~5	TxPDO10 parameter	--
1A00h	0~8	TxPDO1 mapping information	--
...
1A09h	0~8	TxPDO10 mapping information	--

3.3 Application Object

The user can read the object with index 6401h and subindex 1~8 to get the RTD value of the channel 0~7, and the range for each RTD type code are listed in Appendix. If the user wants to change the RTD input type, write the type code to the object with index 2004h and subindex 1~8. For example, if the node ID of CAN-2015C is 1, the following command would be used:

11-bit COB-ID (bit)											RTR	Data Length	8-byte Data (byte)							
Func Code				Node ID																
10	9	8	7	6	5	4	3	2	1	0			0	1	2	3	4	5	6	7
1	1	0	0	0	0	0	0	0	0	1	0	8	2F	04	20	01	21	00	00	00

SDO client



**SDO server
(CAN-2015C)**

11-bit COB-ID (bit)											RTR	Data Length	8-byte Data (byte)							
Func Code				Node ID																
10	9	8	7	6	5	4	3	2	1	0			0	1	2	3	4	5	6	7
1	1	0	0	0	0	0	0	0	0	1	0	8	60	04	20	01	00	00	00	00

SDO client



**SDO server
(CAN-2015C)**

Writing object with index 2004h and subindex 1 with 21h means to change the type code of the RTD channel 0 with 21h.

11-bit COB-ID (bit)											RTR	Data Length	8-byte Data (byte)							
Func Code				Node ID																
10	9	8	7	6	5	4	3	2	1	0			0	1	2	3	4	5	6	7
1	1	0	0	0	0	0	0	0	0	1	0	8	40	01	64	01	00	00	00	00

SDO client



**SDO server
(CAN-2015C)**

11-bit COB-ID (bit)											RTR	Data Length	8-byte Data (byte)							
Func Code				Node ID																
10	9	8	7	6	5	4	3	2	1	0			0	1	2	3	4	5	6	7
1	1	0	0	0	0	0	0	0	0	1	0	8	4B	01	64	01	FF	3F	00	00

SDO client



SDO server
(CAN-2015C)

Reading object with index 6401h and subindex 1 means to get the value of the RTD channel 0. According to the type code 21h set before, the replied value of the RTD channel 0 is 3FFFh.

3.4 Default PDO Mapping

RxPDO mapping list:

ID	Len	D0	D1	D2	D3	D4	D5	D6	D7
200h+x	0	Reserved							
300h+x	0	Reserved							
400h+x	0	Reserved							
500h+x	0	Reserved							

TxPDO mapping list:

ID	Len	D0	D1	D2	D3	D4	D5	D6	D7
180h+x	0	Reserved							
280h+x	8	RTD ch0		RTD ch1		RTD ch2		RTD ch3	
380h+x	8	RTD ch4		RTD ch5		RTD ch6		RTD ch7	
480h+x	0	Reserved							

3.5 EMCY Communication

The data format of the emergency object data follows the structure below.

Byte	0	1	2	3	4	5	6	7
Content	Emergency Error code		Error register	Manufacturer specific Error Field				

Each bit on the error register is defined as follows.

Bit	Meaning
0	Generic error
1	Current
2	Voltage
3	Temperature
4	Communication error (Overrun, error state)
5	Device profile specific
6	Reserved (Always 0)
7	Manufacturer specific

The Emergency error codes and the error register are specified in the following table.

Emergency Error Code		Error Register	Manufacture Specific Error Field		Description	
High Byte	Low Byte		First Byte	Last Four Bytes		
00	00	00	00	00 00 00 00	Error Reset or No Error	
10	00	81	01	00 00 00 00	CAN controller Error Occur	
50	00	81	02	00 00 00 00	EEPROM Access Error	
81	01	11	04	00 00 00 00	Soft Rx Buffer Overrun	
81	01	11	05	00 00 00 00	Soft Tx Buffer Overrun	
81	01	11	06	00 00 00 00	CAN controller Overrun	
81	30	11	07	00 00 00 00	Lift Guarding Fail	
81	40	11	08	00 00 00 00	Recover From Bus Off	
82	10	11	09	00 00 00 00	PDO Data Length Error	
FF	00	80	0A	00 00 00 00	Request To Reset Node or Communication	
FF	00	2E	0B	00 00 Upper limit alarm	00 00 Lower limit alarm	Upper/Lower limit alarm for Each channel

Appendix: Type Code Definition

Type code Definition for CAN-2015C

Type Code	RTD Type	Data Format	Max Value	Min Value
20 (Default)	Pt 100 a=0.00385 -100 to 100 degree Celsius	Engineer Unit	+100.00	-100.00
		% of FSR	+100.00	-100.00
		2's complement HEX	7FFF	8000
		Ohm	+138.50	+060.25
21	Pt 100 a=0.00385 0 to 100 degree Celsius	Engineer Unit	+100.00	+000.00
		% of FSR	+100.00	+000.00
		2's complement HEX	7FFF	0000
		Ohm	+138.50	+100
22	Pt 100 a=0.00385 0 to 200 degree Celsius	Engineer Unit	+200.00	+000.00
		% of FSR	+100.00	+000.00
		2's complement HEX	7FFF	0000
		Ohm	+175.84	+100.00
23	Pt 100 a=0.00385 0 to 600 degree Celsius	Engineer Unit	+600.00	+000.00
		% of FSR	+100.00	+000.00
		2's complement HEX	7FFF	0000
		Ohm	+313.59	+100.00
24	Pt 100 a=0.003916 -100 to 100 degree Celsius	Engineer Unit	+100.00	-100.00
		% of FSR	+100.00	-100.00
		2's complement HEX	7FFF	8000
		Ohm	+139.16	+059.58
25	Pt 100 a=0.003916 0 to 100 degree Celsius	Engineer Unit	+100.00	+000.00
		% of FSR	+100.00	+000.00
		2's complement HEX	7FFF	0000
		Ohm	+139.16	+100.00
26	Pt 100 a=0.003916 0 to 200 degree Celsius	Engineer Unit	+200.00	+000.00
		% of FSR	+100.00	+000.00
		2's complement HEX	7FFF	0000
		Ohm	+177.13	+100.00
27	Pt 100 a=0.003916 0 to 600 degree Celsius	Engineer Unit	+600.00	+000.00
		% of FSR	+100.00	+000.00
		2's complement HEX	7FFF	0000
		Ohm	+317.28	+100.00
28	Nickel 120 -80 to 100 degree Celsius	Engineer Unit	+100.00	-080.00
		% of FSR	+100.00	-080.00

		2's complement HEX	7FFF	999A
		Ohm	+200.64	+120.60
29	Nickel 120 0 to 100 degree Celsius	Engineer Unit	+100.00	+000.00
		% of FSR	+100.00	+000.00
		2's complement HEX	7FFF	0000
		Ohm	+200.64	+120.60
2A	Pt 1000 a=0.00385 -200 to 600 degree Celsius	Engineer Unit	+600.00	-200.00
		% of FSR	+100.00	-033.33
		2's complement HEX	7FFF	D556
		Ohm	+3137.1	+0185.2
2B	Cu 100 a=0.00421 -20 to 150 degree Celsius	Engineer Unit	+150.00	-020.00
		% of FSR	+100.00	-013.33
		2's complement HEX	7FFF	EEEE
		Ohm	+163.17	+091.56
2C	Cu 100 a=0.00421 0 to 200 degree Celsius	Engineer Unit	+200.00	-000.00
		% of FSR	+100.00	-000.00
		2's complement HEX	7FFF	0000
		Ohm	+167.75	+090.34
2D	Cu 1000 a=0.00421 -20 to 150 degree Celsius	Engineer Unit	+150.00	-020.00
		% of FSR	+100.00	-013.33
		2's complement HEX	7FFF	EEEE
		Ohm	+1631.7	+0915.6
2E	Pt 100 a=0.00385 -200 to 200 degree Celsius	Engineer Unit	+200.00	-200.00
		% of FSR	+100.00	-100.00
		2's complement HEX	7FFF	8000
		Ohm	+175.84	+018.49
2F	Pt 100 a=0.003916 -200 to 200 degree Celsius	Engineer Unit	+200.00	-200.00
		% of FSR	+100.00	-100.00
		2's complement HEX	7FFF	8000
		Ohm	+177.14	+017.14
80	Pt 100 a=0.00385 -200 to 600 degree Celsius	Engineer Unit	+600.00	-200.00
		% of FSR	+100.00	-033.33
		2's complement HEX	7FFF	D556
		Ohm	+313.59	+018.49
81	Pt 100 a=0.003916 -200 to 600 degree Celsius	Engineer Unit	+600.00	-200.00
		% of FSR	+100.00	-033.33
		2's complement HEX	7FFF	D556
		Ohm	+317.28	+017.14