

MODEL:
HYPER-KBN

PICO-ITX SBC with AMD® G-Series SoC Processor,
DDR3, DVI-I/LVDS, GbE, USB 3.0,
SATA 6Gb/s, Audio and RoHS

User Manual

Revision

Date	Version	Changes
27 December, 2013	1.02	Update Appendix D: Example program for WDT
27 November, 2013	1.01	Update Section 2.3: Packing List
21 October, 2013	1.00	Initial release

Copyright

COPYRIGHT NOTICE

The information in this document is subject to change without prior notice in order to improve reliability, design and function and does not represent a commitment on the part of the manufacturer.

In no event will the manufacturer be liable for direct, indirect, special, incidental, or consequential damages arising out of the use or inability to use the product or documentation, even if advised of the possibility of such damages.

This document contains proprietary information protected by copyright. All rights are reserved. No part of this manual may be reproduced by any mechanical, electronic, or other means in any form without prior written permission of the manufacturer.

TRADEMARKS

All registered trademarks and product names mentioned herein are used for identification purposes only and may be trademarks and/or registered trademarks of their respective owners.

Table of Contents

1 INTRODUCTION	1
1.1 INTRODUCTION	2
1.2 MODEL VARIATIONS.....	2
1.3 FEATURES	3
1.4 CONNECTORS.....	4
1.5 DIMENSIONS.....	5
1.6 DATA FLOW.....	6
1.7 TECHNICAL SPECIFICATIONS.....	7
2 UNPACKING	9
2.1 ANTI-STATIC PRECAUTIONS	10
2.2 UNPACKING PRECAUTIONS	10
2.3 PACKING LIST.....	11
2.4 OPTIONAL ITEMS	12
3 CONNECTORS	13
3.1 PERIPHERAL INTERFACE CONNECTORS.....	14
3.1.1 HYPER-KBN Layout.....	14
3.1.2 Peripheral Interface Connectors	15
3.1.3 External Interface Panel Connectors.....	16
3.2 INTERNAL PERIPHERAL CONNECTORS.....	16
3.2.1 AT/ATX Mode Select Switch.....	16
3.2.2 Audio Connector	17
3.2.3 Battery Connector.....	18
3.2.4 Buzzer Connector.....	19
3.2.5 Clear CMOS Button.....	20
3.2.6 DDR3 SO-DIMM Slot.....	21
3.2.7 Front Panel Connector	21
3.2.8 LAN LED Connector.....	22
3.2.9 LVDS LCD Connector	23
3.2.10 LVDS Backlight Inverter Connector	24

HYPER-KBN

3.2.11 Power Button Connector.....	25
3.2.12 Reset Button Connector	26
3.2.13 RS-232 Serial Port Connector	26
3.2.14 SATA 6Gb/s Drive Connector	27
3.2.15 SATA Power Connector.....	28
3.2.16 SPI Flash Connector.....	29
3.2.17 System Fan Connector	29
3.2.18 USB Connector	30
3.3 EXTERNAL PERIPHERAL INTERFACE CONNECTOR PANEL	31
3.3.1 DVI Connector.....	32
3.3.2 LAN Connectors.....	32
3.3.3 Power Connectors.....	33
3.3.4 USB Connectors.....	34
4 INSTALLATION.....	35
4.1 ANTI-STATIC PRECAUTIONS.....	36
4.2 INSTALLATION CONSIDERATIONS	36
4.3 SO-DIMM INSTALLATION.....	38
4.4 INTERNAL PERIPHERAL DEVICE CONNECTIONS.....	39
4.4.1 Audio Kit Installation.....	39
4.4.2 SATA Drive Connection	40
4.4.3 Single RS-232 Cable	41
4.5 EXTERNAL PERIPHERAL INTERFACE CONNECTION.....	42
4.5.1 DVI Display Device Connection.....	42
4.5.2 LAN Connection.....	43
4.5.3 USB Connection.....	44
4.6 HEAT SINK ENCLOSURE	45
5 BIOS	47
5.1 INTRODUCTION	48
5.1.1 Starting Setup.....	48
5.1.2 Using Setup	48
5.1.3 Getting Help.....	49
5.1.4 Unable to Reboot after Configuration Changes	49
5.1.5 BIOS Menu Bar.....	49

5.2 MAIN	50
5.3 ADVANCED.....	51
5.3.1 ACPI Settings.....	52
5.3.2 RTC Wake Settings.....	52
5.3.3 CPU Configuration.....	54
5.3.4 IDE Configuration.....	55
5.3.5 USB Configuration.....	56
5.3.6 F81216 Super IO Configuration.....	57
5.3.6.1 Serial Port 1 Configuration.....	58
5.3.7 Serial Port Console Redirection.....	59
5.3.7.1 Console Redirection Settings.....	60
5.4 CHIPSET.....	62
5.4.1 GFX Configuration.....	63
5.4.2 South Bridge Configuration.....	63
5.4.3 North Bridge Configuration.....	65
5.4.4 VUMA INT15 Config Select.....	66
5.5 BOOT.....	68
5.6 SECURITY.....	70
5.7 EXIT.....	70
A BIOS MENU OPTIONS	72
B ONE KEY RECOVERY.....	75
B.1 ONE KEY RECOVERY INTRODUCTION.....	76
B.1.1 System Requirement.....	77
B.1.2 Supported Operating System.....	78
B.2 SETUP PROCEDURE FOR WINDOWS.....	79
B.2.1 Hardware and BIOS Setup.....	80
B.2.2 Create Partitions.....	80
B.2.3 Install Operating System, Drivers and Applications.....	84
B.2.4 Building the Recovery Partition.....	85
B.2.5 Create Factory Default Image.....	87
B.3 AUTO RECOVERY SETUP PROCEDURE.....	92
B.4 SETUP PROCEDURE FOR LINUX.....	96
B.5 RECOVERY TOOL FUNCTIONS.....	100
B.5.1 Factory Restore.....	101

HYPER-KBN

<i>B.5.2 Backup System</i>	102
<i>B.5.3 Restore Your Last Backup</i>	103
<i>B.5.4 Manual</i>	104
<i>B.6 RESTORE SYSTEMS FROM A LINUX SERVER THROUGH LAN</i>	105
<i>B.6.1 Configure DHCP Server Settings</i>	106
<i>B.6.2 Configure TFTP Settings</i>	107
<i>B.6.3 Configure One Key Recovery Server Settings</i>	108
<i>B.6.4 Start the DHCP, TFTP and HTTP</i>	109
<i>B.6.5 Create Shared Directory</i>	109
<i>B.6.6 Setup a Client System for Auto Recovery</i>	110
<i>B.7 OTHER INFORMATION</i>	113
<i>B.7.1 Using AHCI Mode or ALi M5283 / VIA VT6421A Controller</i>	113
<i>B.7.2 System Memory Requirement</i>	115
<i>C TERMINOLOGY</i>	116
<i>D WATCHDOG TIMER</i>	121
<i>E HAZARDOUS MATERIALS DISCLOSURE</i>	124
<i>E.1 HAZARDOUS MATERIAL DISCLOSURE TABLE FOR IPB PRODUCTS CERTIFIED AS RoHS COMPLIANT UNDER 2002/95/EC WITHOUT MERCURY</i>	125

List of Figures

Figure 1-1: HYPER-KBN.....	2
Figure 1-2: Connectors	4
Figure 1-3: Dimensions (mm).....	5
Figure 1-4: Data Flow Diagram.....	6
Figure 3-1: Connector and Jumper Locations (Front).....	14
Figure 3-2: Connector and Jumper Locations (Rear).....	15
Figure 3-3: AT/ATX Mode Select Switch Location	17
Figure 3-4: Audio Connector Location.....	18
Figure 3-5: Battery Connector Location.....	19
Figure 3-6: Battery Connector Location.....	19
Figure 3-7: Clear CMOS Button Location.....	20
Figure 3-8: DDR3 SO-DIMM Slot Location.....	21
Figure 3-9: Front Panel Connector Location	22
Figure 3-10: LAN LED Connector Location	23
Figure 3-11: LVDS Connector Location.....	23
Figure 3-12: Backlight Inverter Connector Location.....	24
Figure 3-13: Power Button Connector Location.....	25
Figure 3-14: Reset Button Connector Location.....	26
Figure 3-15: RS-232 Serial Port Connector Location.....	27
Figure 3-16: SATA 6Gb/s Drive Connector Location	28
Figure 3-17: SATA Power Connector Location	28
Figure 3-18: SPI Flash Connector Location.....	29
Figure 3-19: System Fan Connector Locations.....	30
Figure 3-20: USB Connector Locations.....	31
Figure 3-21: External Peripheral Interface Connector	31
Figure 3-22: LAN Connector	33
Figure 4-1: SO-DIMM Installation	38
Figure 4-2: Audio Kit Cable Connection.....	39
Figure 4-3: SATA Drive Cable Connection.....	40
Figure 4-4: Single RS-232 Cable Installation	41
Figure 4-5: DVI Connector	43

HYPER-KBN

Figure 4-6: LAN Connection	44
Figure 4-7: USB Connector	45
Figure 4-8: Heat Sink Retention Screws.....	46
Figure B-1: IEI One Key Recovery Tool Menu	76
Figure B-2: Launching the Recovery Tool	81
Figure B-3: Recovery Tool Setup Menu	81
Figure B-4: Command Prompt	82
Figure B-5: Partition Creation Commands.....	83
Figure B-6: Launching the Recovery Tool	85
Figure B-7: Manual Recovery Environment for Windows	85
Figure B-8: Building the Recovery Partition.....	86
Figure B-9: Press Any Key to Continue	86
Figure B-10: Press F3 to Boot into Recovery Mode.....	87
Figure B-11: Recovery Tool Menu	87
Figure B-12: About Symantec Ghost Window.....	88
Figure B-13: Symantec Ghost Path	88
Figure B-14: Select a Local Source Drive	89
Figure B-15: Select a Source Partition from Basic Drive	89
Figure B-16: File Name to Copy Image to	90
Figure B-17: Compress Image.....	90
Figure B-18: Image Creation Confirmation	91
Figure B-19: Image Creation Complete	91
Figure B-20: Image Creation Complete	91
Figure B-21: Press Any Key to Continue	92
Figure B-22: Auto Recovery Utility	93
Figure B-23: Launching the Recovery Tool	93
Figure B-24: Auto Recovery Environment for Windows	93
Figure B-25: Building the Auto Recovery Partition.....	94
Figure B-26: Factory Default Image Confirmation	94
Figure B-27: Image Creation Complete	95
Figure B-28: Press any key to continue	95
Figure B-29: Partitions for Linux.....	97
Figure B-30: Manual Recovery Environment for Linux	98
Figure B-31: Access menu.lst in Linux (Text Mode).....	99
Figure B-32: Recovery Tool Menu	99

Figure B-33: Recovery Tool Main Menu100
Figure B-34: Restore Factory Default101
Figure B-35: Recovery Complete Window102
Figure B-36: Backup System102
Figure B-37: System Backup Complete Window103
Figure B-38: Restore Backup103
Figure B-39: Restore System Backup Complete Window104
Figure B-40: Symantec Ghost Window104

List of Tables

Table 1-1: HYPER-KBN Model Variations.....	2
Table 1-2: Technical Specifications.....	8
Table 3-1: Peripheral Interface Connectors.....	16
Table 3-2: Rear Panel Connectors.....	16
Table 3-3: AT/ATX Mode Select Switch Settings.....	17
Table 3-4: Audio Connector Pinouts.....	18
Table 3-5: Battery Connector Pinouts.....	19
Table 3-6: Battery Connector Pinouts.....	20
Table 3-7: Clear CMOS Button Settings.....	20
Table 3-8: Front Panel Connector Pinouts.....	22
Table 3-9: LAN LED Connector Pinouts.....	23
Table 3-10: LVDS Connector Pinouts.....	24
Table 3-11: Backlight Inverter Connector Pinouts.....	25
Table 3-12: Power Button Connector Pinouts.....	25
Table 3-13: Reset Button Connector Pinouts.....	26
Table 3-14: RS-232 Serial Port Connector Pinouts.....	27
Table 3-15: SATA Power Connector Pinouts.....	28
Table 3-16: SPI Flash Connector Pinouts.....	29
Table 3-17: System Fan Connector Pinouts.....	30
Table 3-18: USB Connector Pinouts.....	31
Table 3-19: DVI Connector Pinouts.....	32
Table 3-20: LAN Pinouts.....	33
Table 3-21: Connector LEDs.....	33
Table 3-22: Power Connector Pinouts.....	34
Table 3-23: USB 3.0 Port Pinouts.....	34
Table 5-1: BIOS Navigation Keys.....	49

List of BIOS Menus

BIOS Menu 1: Main	50
BIOS Menu 2: Advanced	51
BIOS Menu 3: ACPI Configuration	52
BIOS Menu 4: RTC Wake Settings	53
BIOS Menu 5: CPU Configuration	54
BIOS Menu 6: IDE Configuration	55
BIOS Menu 7: USB Configuration	56
BIOS Menu 8: Super IO Configuration.....	57
BIOS Menu 9: Serial Port 1 Configuration Menu	58
BIOS Menu 10: Serial Port Console Redirection	59
BIOS Menu 11: Console Redirection Settings.....	60
BIOS Menu 12: Chipset	62
BIOS Menu 13: GFX Configuration	63
BIOS Menu 14: South Bridge Configuration.....	64
BIOS Menu 15: North Bridge Configuration	65
BIOS Menu 16: VUMA INT15 Configuration	66
BIOS Menu 17: Boot	68
BIOS Menu 18: Security	70
BIOS Menu 19:Exit.....	71
BIOS Menu 20: IEI Feature.....	96

Chapter

1

Introduction

1.1 Introduction

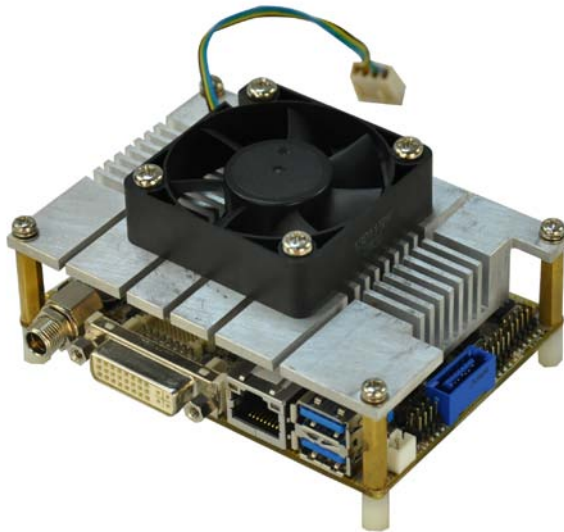

Figure 1-1: HYPER-KBN

The HYPER-KBN PICO-ITX motherboard is an AMD® G-Series SoC processor platform. It supports one 1600/1333 MHz DDR3 SO-DIMM up to 8.0 GB.

The HYPER-KBN includes a LVDS connector and a DVI-I connector. Expansion and I/O include two USB 3.0 connectors on the rear panel, two USB 2.0 connectors by pin header and one SATA 6Gb/s connector. Serial device connectivity is provided by one internal RS-232 connector. One RJ-45 Ethernet connector provides the system with smooth connections to an external LAN.

1.2 Model Variations

The model variations of the HYPER-KBN Series are listed below.

Model No.	SoC
HYPER-KBN-4151-R10	AMD® G-Series GX-415GA, 15W, 1.5GHz
HYPER-KBN-2101-R10	AMD® G-Series GX-210HA, 9W, 1.0GHz

Table 1-1: HYPER-KBN Model Variations

HYPER-KBN

1.3 Features

Some of the HYPER-KBN motherboard features are listed below:

- PICO-ITX form factor with AMD® G-Series SoC processor supports DDR3 1600/1333 MHz memory
- 12V only single voltage design for AT/ATX power by DC power jack
- DVI-I and 18-bit single channel LVDS support for dual displays
- IEI One Key Recovery solution allows you to create rapid OS backup and recovery

1.4 Connectors

The connectors on the HYPER-KBN are shown in the figure below.

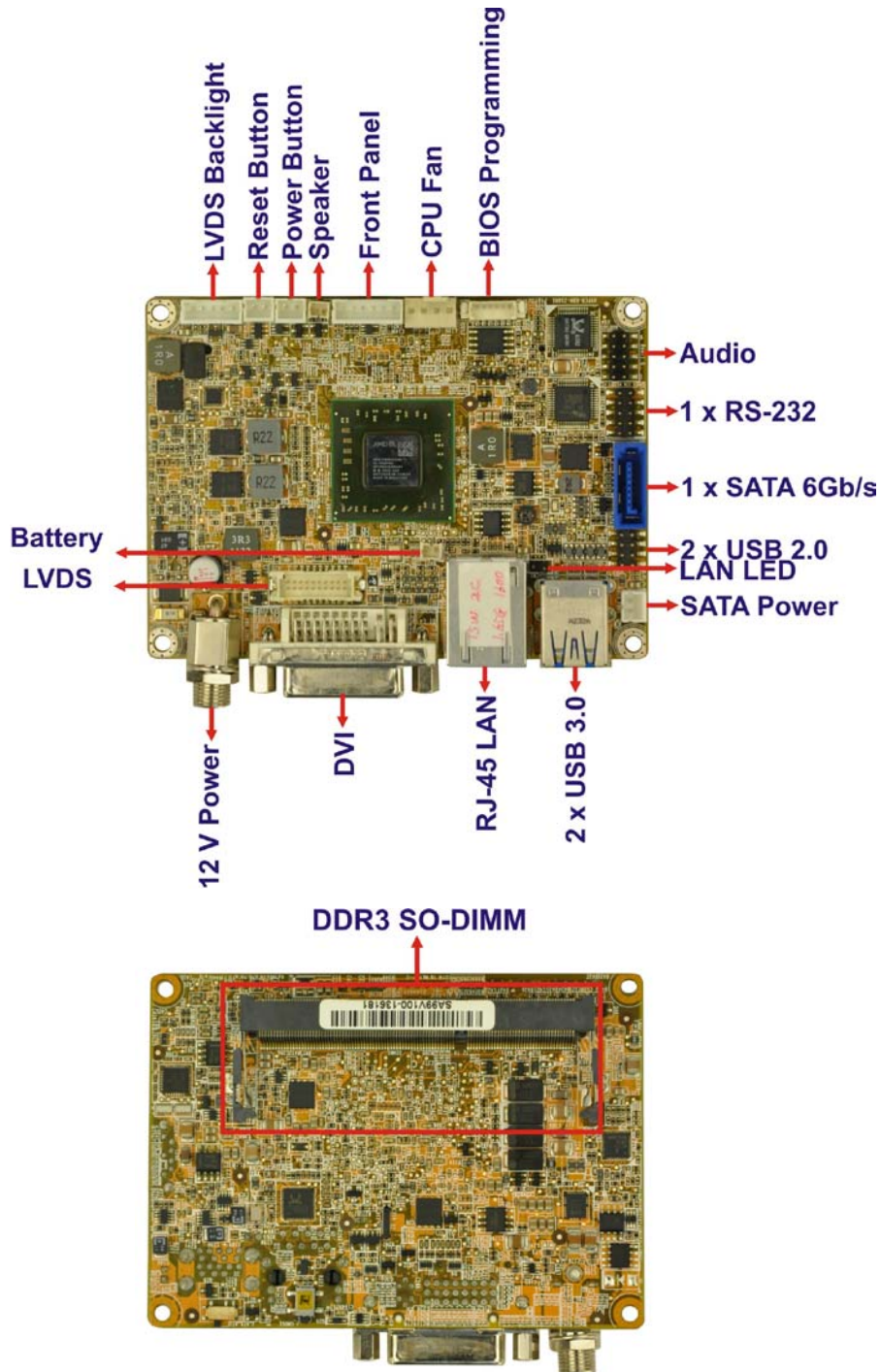

Figure 1-2: Connectors

HYPER-KBN

1.5 Dimensions

The dimensions of the board are listed below:

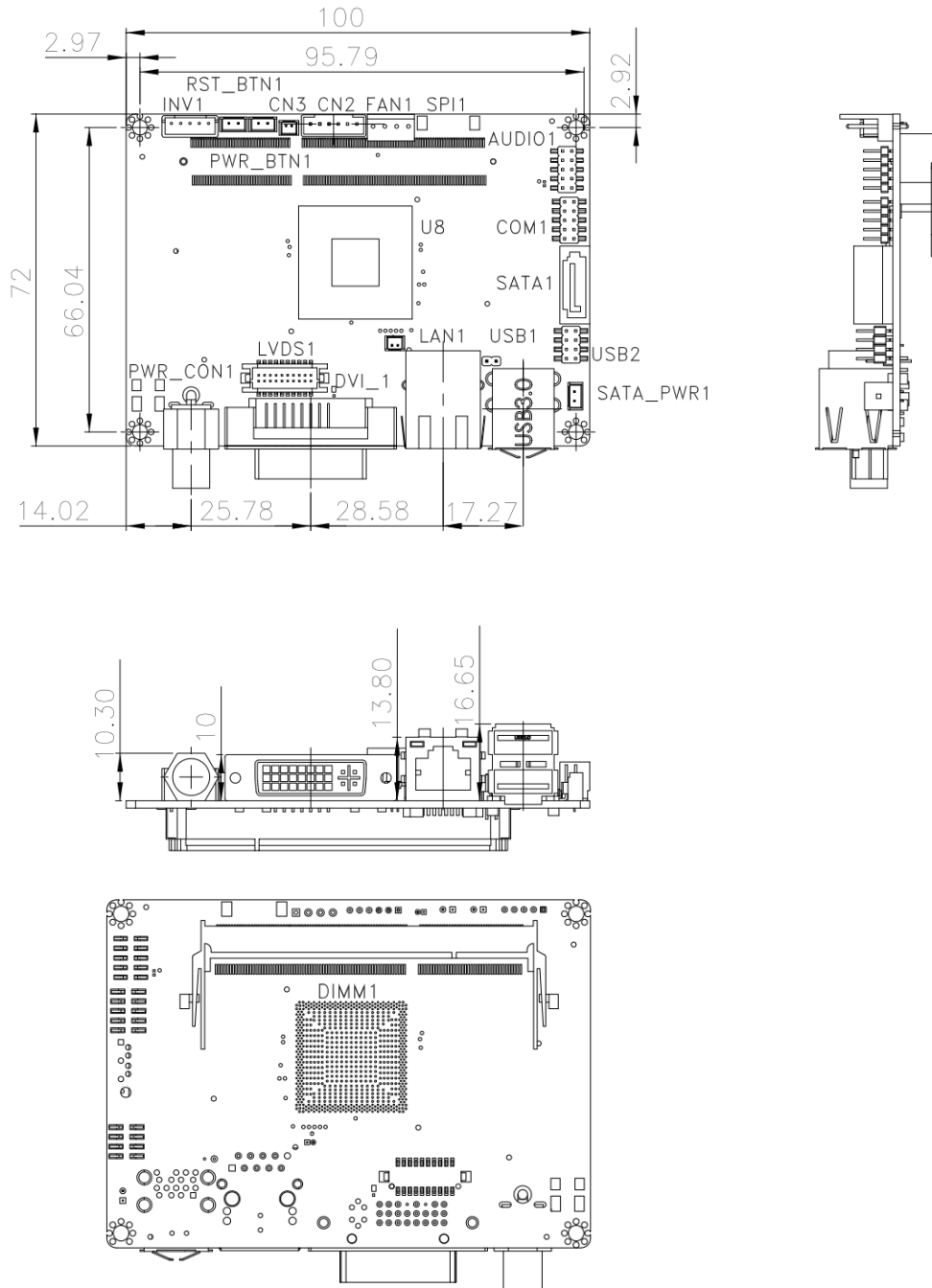

Figure 1-3: Dimensions (mm)

1.6 Data Flow

Figure 1-4 shows the data flow between the system chipset, the CPU and other components installed on the motherboard.

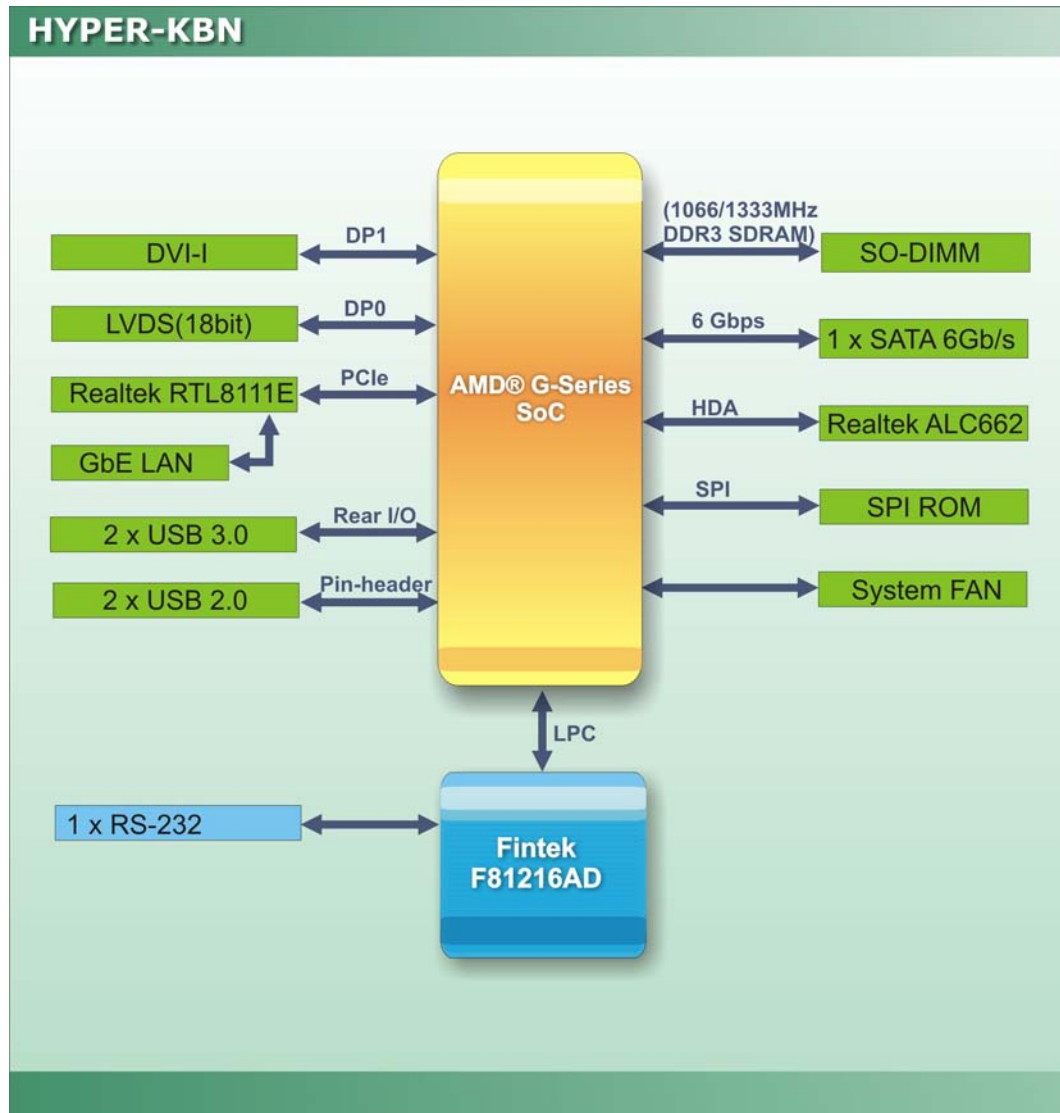

Figure 1-4: Data Flow Diagram

HYPER-KBN

1.7 Technical Specifications

HYPER-KBN technical specifications are listed below.

Specification	HYPER-KBN
SoC	AMD® G-Series SoC processor
Memory	One 204-pin 1600/1333 MHz single-channel DDR3 SO-DIMM supported (system max. 8GB)
BIOS	UEFI BIOS
Ethernet	1 x PCIe GbE by Realtek RTL8111E with ASF 2.0 support
Graphics	GPU frequency 300MHz (Radeon™ HD 8310E), DirectX ® 11.1, UVD4.2, HDMI™ 1.4a, DisplayPort 1.2
Display Output	Dual display support 1 x DVI-I (1920x1200@60Hz) 1 x 18-bit single channel LVDS (1600x900@60Hz)
UART IC	Fintek F81216AD
Audio	Realtek ALC662 HD Audio codec
Watchdog Timer	Software programmable supports 1~255 sec. system reset
I/O Interface Connectors	
Audio Connector	1 x Analog audio by 10-pin (2x5) header
Ethernet	One RJ-45 port
Fan	1 x 4-pin system fan connector
Serial Ports	1 x RS-232 by 10-pin (2x5) header
USB Ports	2 x USB3.0 (on rear I/O) 2 x USB2.0 by 8-pin (2x4) header
Front Panel	1 x 6-pin (1x6) wafer for power LED & HDD LED 1 x 2-pin (1x2) wafer for power button 1 x 2-pin (1x2) wafer for reset button
LAN LED	1 x 2-pin (1x2) header
Storage	

Specification	HYPER-KBN
Serial ATA	1 x SATA 6Gb/s with 5V SATA power connector (NO RAID)
Environmental and Power Specifications	
Power Supply	12V DC power input only, AT/ATX supported 1 x External DC power jack
Power Consumption	TBD
Operating Temperature	-10°C ~ 60°C
Storage Temperature	-20°C ~ 85°C
Humidity	5% ~ 95% (non-condensing)
Physical Specifications	
Dimensions	100 mm x 72 mm
Weight GW/NW	600 g / 250 g

Table 1-2: Technical Specifications

Chapter

2

Unpacking

2.1 Anti-static Precautions



WARNING!

Static electricity can destroy certain electronics. Make sure to follow the ESD precautions to prevent damage to the product, and injury to the user.

Make sure to adhere to the following guidelines:

- **Wear an anti-static wristband:** Wearing an anti-static wristband can prevent electrostatic discharge.
- **Self-grounding:** Touch a grounded conductor every few minutes to discharge any excess static buildup.
- **Use an anti-static pad:** When configuring any circuit board, place it on an anti-static mat.
- **Only handle the edges of the PCB:** Don't touch the surface of the motherboard. Hold the motherboard by the edges when handling.

2.2 Unpacking Precautions

When the HYPER-KBN is unpacked, please do the following:

- Follow the antistatic guidelines above.
- Make sure the packing box is facing upwards when opening.
- Make sure all the packing list items are present.

HYPER-KBN







2.3 Packing List







NOTE:

If any of the components listed in the checklist below are missing, do not proceed with the installation. Contact the IEI reseller or vendor the HYPER-KBN was purchased from or contact an IEI sales representative directly by sending an email to sales@iei.com.tw.

The HYPER-KBN is shipped with the following components:

Quantity	Item and Part Number	Image
1	HYPER-KBN motherboard	
1	Specific heat sink and fan module (Heat Sink P/N: 34000-000526-RS) (CPU Fan P/N: 31100-000339-RS)	
4	Hex head studs (P/N: 44310-030201-RS)	
4	Intermediate poles (P/N: 46005-462400-RS)	
4	Retention screws (P/N: 44003-030062-RS)	
1	Audio cable (P/N: 32000-072100-RS)	

1	SATA with 5V output cable kit (P/N: 32801-000201-100-RS)	
1	RS-232 cable (P/N: 32200-000049-RS)	
1	Utility CD	
1	One Key Recovery CD	
1	Quick Installation Guide	

2.4 Optional Items

The following are optional components which may be separately purchased:

Item and Part Number	Image
Dual-port USB cable without bracket (P/N: 32000-070301-RS)	

Chapter

3

Connectors

3.1 Peripheral Interface Connectors

This chapter details all the jumpers and connectors.

3.1.1 HYPER-KBN Layout

The figures below show all the connectors and jumpers.

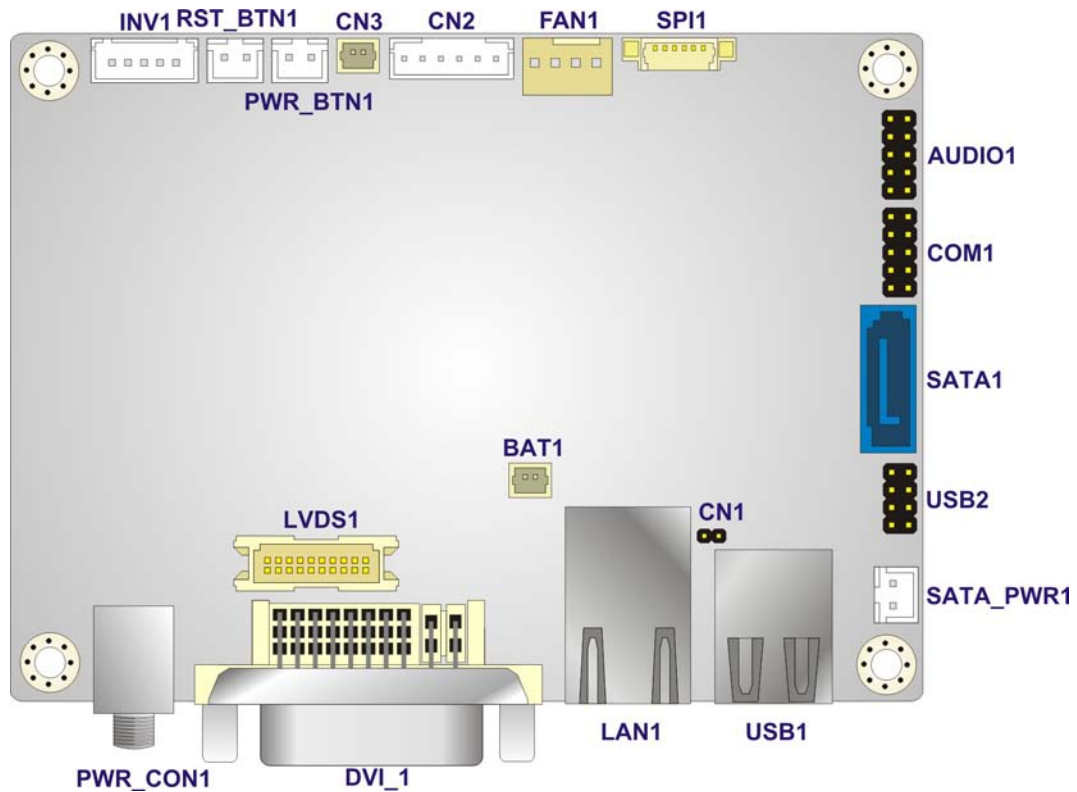

Figure 3-1: Connector and Jumper Locations (Front)

HYPER-KBN

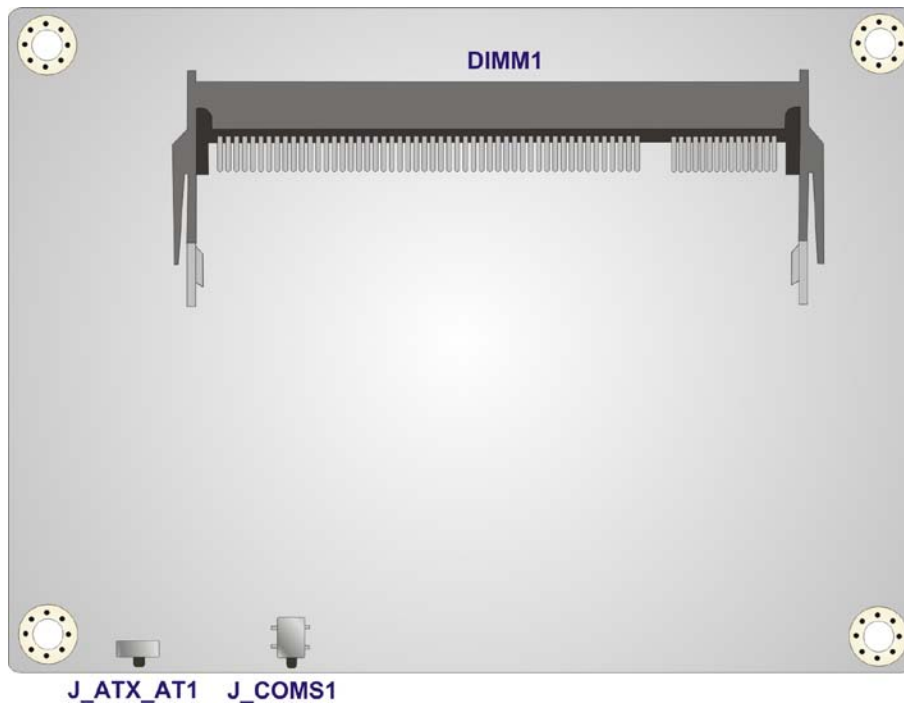

Figure 3-2: Connector and Jumper Locations (Rear)

3.1.2 Peripheral Interface Connectors

The table below lists all the connectors on the board.

Connector	Type	Label
AT/ATX mode select switch	switch	J_ATX_AT1
Audio connector	10-pin header	AUDIO1
Battery connector	2-pin wafer	BAT1
Buzzer connector	2-pin wafer	CN3
Clear CMOS button	button	J_CMOS1
DDR3 SO-DIMM slot	DDR3 SO-DIMM slot	DIMM1
Front panel connector	6-pin wafer	CN2
LAN LED connector	2-pin header	CN1
LVDS LCD connector	20-pin crimp	LVDS1

LVDS backlight inverter connector	5-pin wafer	INV1
Power button connector	2-pin wafer	PWR_BTN1
Reset button connector	2-pin wafer	RST_BTN1
RS-232 serial port connector	10-pin header	COM1
SATA 6Gb/s drive connector	7-pin SATA connector	SATA1
SATA power connector	2-pin wafer	SATA_PWR1
SPI Flash connector	6-pin wafer	SPI1
System fan connector	4-pin wafer	FAN1
USB connector	8-pin header	USB2

Table 3-1: Peripheral Interface Connectors

3.1.3 External Interface Panel Connectors

The table below lists the connectors on the external I/O panel.

Connector	Type	Label
DVI connector	24-pin female	DVI_1
LAN connector	RJ-45	LAN1
Power connector	DC power jack	PWR_CON1
USB connector	USB 3.0	USB1

Table 3-2: Rear Panel Connectors

3.2 Internal Peripheral Connectors

The section describes all of the connectors on the HYPER-KBN.

3.2.1 AT/ATX Mode Select Switch

CN Label: **J_ATX_AT1**

HYPER-KBN

- CN Type: switch
- CN Location: See **Figure 3-3**
- CN Settings: See **Table 3-3**

The AT/ATX mode select switch specifies the systems power mode as AT or ATX. AT/ATX mode select switch settings are shown in **Table 3-3**.

Setting	Description	
Short 1-2	AT Mode	
Short 2-3	ATX Mode	Default

Table 3-3: AT/ATX Mode Select Switch Settings

The location of the AT/ATX mode select switch is shown in **Figure 3-3** below.

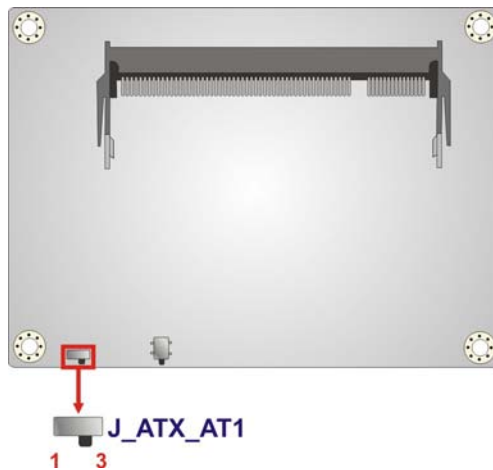

Figure 3-3: AT/ATX Mode Select Switch Location

3.2.2 Audio Connector

- CN Label: **AUDIO1**
- CN Type: 10-pin header
- CN Location: See **Figure 3-4**
- CN Pinouts: See **Table 3-4**

The audio connector is connected to external audio devices including speakers and microphones for the input and output of audio signals to and from the system.

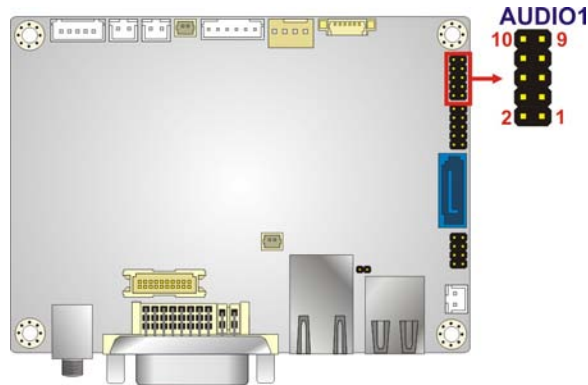

Figure 3-4: Audio Connector Location

PIN NO.	DESCRIPTION	PIN NO.	DESCRIPTION
1	LINEOUT1R	2	LINE1R
3	GND_AUDIO	4	GND_AUDIO
5	LINEOUT1L	6	LINE1L
7	GND_AUDIO	8	GND_AUDIO
9	FMIC1R	10	FMIC1L

Table 3-4: Audio Connector Pinouts

3.2.3 Battery Connector

- CN Label: **BAT1**
- CN Type: 2-pin wafer
- CN Location: See **Figure 3-5**
- CN Pinouts: See **Table 3-5**

The battery connector is connected to the system battery. The battery provides power to the system clock to retain the time when power is turned off.

HYPER-KBN

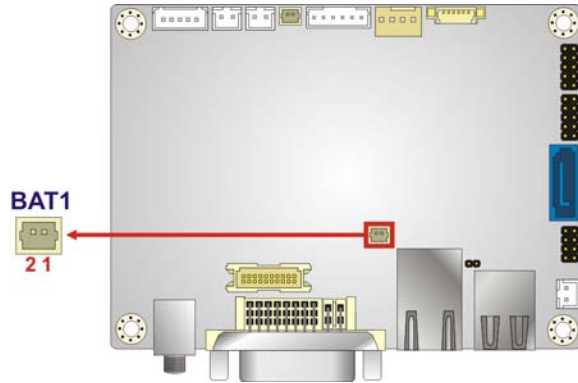

Figure 3-5: Battery Connector Location

PIN NO.	DESCRIPTION	PIN NO.	DESCRIPTION
1	+VBAT	2	GND

Table 3-5: Battery Connector Pinouts

3.2.4 Buzzer Connector

- CN Label: **CN3**
- CN Type: 2-pin wafer
- CN Location: See **Figure 3-6**
- CN Pinouts: See **Table 3-6**

The buzzer connector is connected to the buzzer.

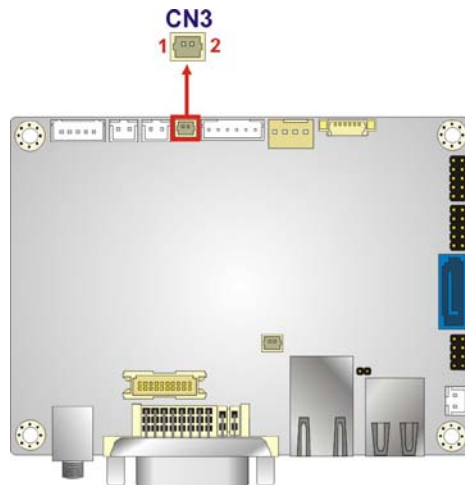

Figure 3-6: Buzzer Connector Location

PIN NO.	DESCRIPTION	PIN NO.	DESCRIPTION
1	SPKR+	2	SPKR-

Table 3-6: Battery Connector Pinouts

3.2.5 Clear CMOS Button

- CN Label: J_CMOS1
- CN Type: button
- CN Location: See **Figure 3-7**
- CN Settings: See **Table 3-7**

If the HYPER-KBN fails to boot due to improper BIOS settings, use the button to clear the CMOS data and reset the system BIOS information.

The clear CMOS button settings are shown in **Table 3-7**.

Setting	Description	
Open	Normal Operation	Default
Push	Clear CMOS Setup	

Table 3-7: Clear CMOS Button Settings

The location of the clear CMOS button is shown in **Figure 3-7**.

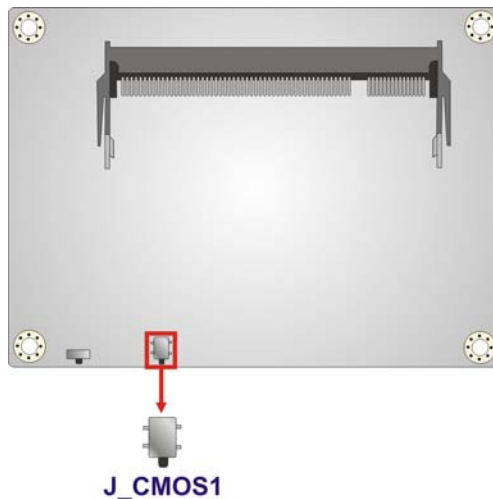

Figure 3-7: Clear CMOS Button Location

HYPER-KBN

3.2.6 DDR3 SO-DIMM Slot

CN Label:	DIMM1
CN Type:	DDR3 SO-DIMM slot
CN Location:	See Figure 3-8

The DDR3 SO-DIMM slot is for DDR3 SO-DIMM memory module.

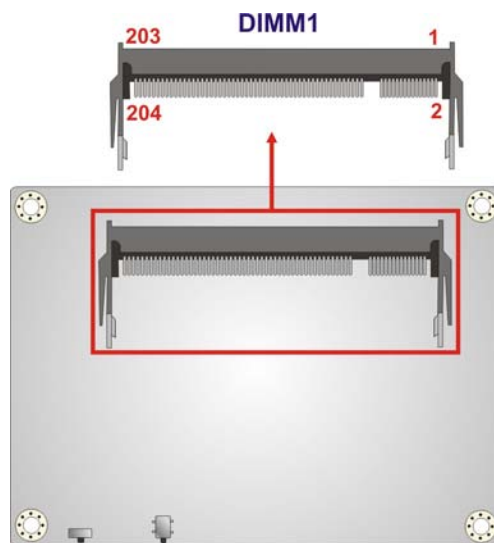

Figure 3-8: DDR3 SO-DIMM Slot Location

3.2.7 Front Panel Connector

CN Label:	CN2
CN Type:	6-pin wafer
CN Location:	See Figure 3-9
CN Pinouts:	See Table 3-8

The front panel connector connects to the indicator LEDs on the system front panel.

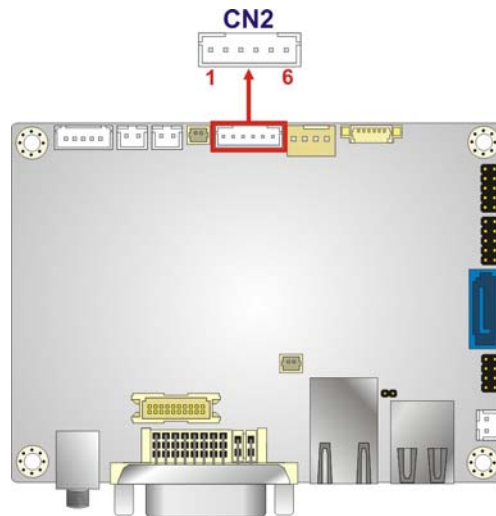

Figure 3-9: Front Panel Connector Location

PIN NO.	DESCRIPTION	PIN NO.	DESCRIPTION
1	+5V	2	GND
3	PWR LED+	4	PWR LED-
5	HDD LED+	6	HDD LED-

Table 3-8: Front Panel Connector Pinouts

3.2.8 LAN LED Connector

- CN Label: CN1
- CN Type: 2-pin header
- CN Location: See **Figure 3-10**
- CN Pinouts: See **Table 3-9**

The LAN LED connectors connect to the LAN link LEDs on the system.

HYPER-KBN

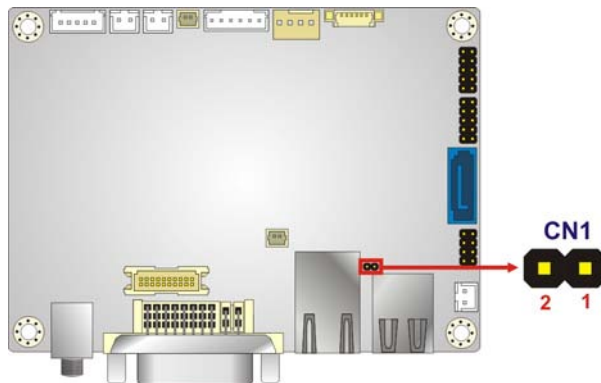

Figure 3-10: LAN LED Connector Location

PIN NO.	DESCRIPTION	PIN NO.	DESCRIPTION
1	LAN1_AVDD33	2	LAN1_LED0_LINK_ACT#

Table 3-9: LAN LED Connector Pinouts

3.2.9 LVDS LCD Connector

- CN Label: LVDS 1
- CN Type: 20-pin crimp
- CN Location: See **Figure 3-11**
- CN Pinouts: See **Table 3-10**

The LVDS connector is for an LCD panel connected to the board.

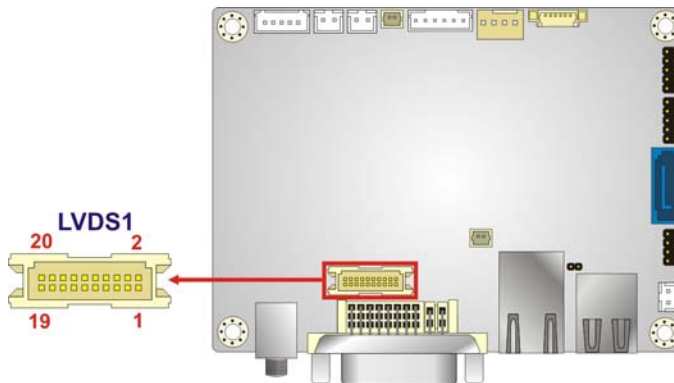

Figure 3-11: LVDS Connector Location

Pin	Description	Pin	Description
1	GND	2	GND
3	DPO_TX0P	4	DPO_TX0N
5	DPO_TX1P	6	DPO_TX1N
7	DPO_TX2P	8	DPO_TX2N
9	DPO_TX3P	10	DPO_TX3N
11	NC	12	NC
13	GND	14	GND
15	DPO_AUXN	16	DPO_AUXP
17	VCC_LCD	18	VCC_LCD
19	VCC_LCD	20	VCC_LCD

Table 3-10: LVDS Connector Pinouts

3.2.10 LVDS Backlight Inverter Connector

- CN Label: INV1
- CN Type: 5-pin wafer
- CN Location: See **Figure 3-12**
- CN Pinouts: See **Table 3-11**

The backlight inverter connector provides power to an LCD panel.

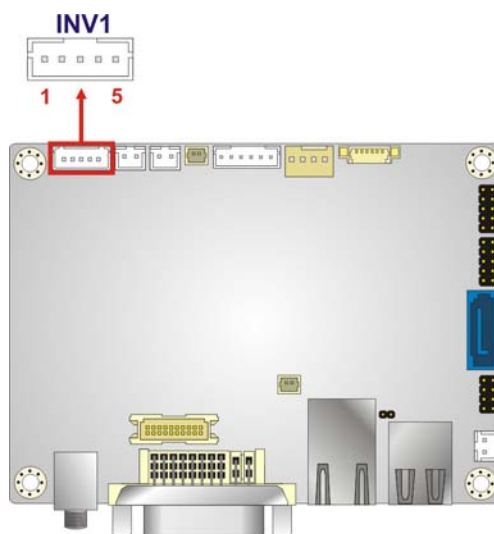

Figure 3-12: Backlight Inverter Connector Location

HYPER-KBN

Pin	Description
1	BRIGHTNESS
2	GND
3	BKL_PWR
4	GND
5	ENABKL

Table 3-11: Backlight Inverter Connector Pinouts

3.2.11 Power Button Connector

CN Label: PWR_BTN1

CN Type: 2-pin wafer

CN Location: See **Figure 3-13**

CN Pinouts: See **Table 3-12**

The power button connector is connected to a power switch on the system chassis to enable users to turn the system on and off.

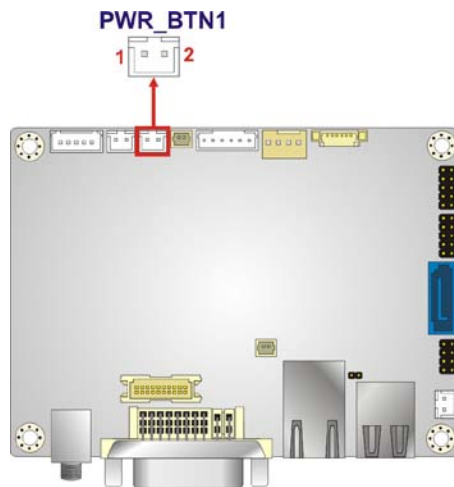

Figure 3-13: Power Button Connector Location

Pin	Description
1	PWR_BTN+
2	PWR_BTN-

Table 3-12: Power Button Connector Pinouts

3.2.12 Reset Button Connector

- CN Label: RST_BTN1
- CN Type: 2-pin wafer
- CN Location: See **Figure 3-14**
- CN Pinouts: See **Table 3-13**

The reset button connector is connected to a reset switch on the system chassis to enable users to reboot the system when the system is turned on.

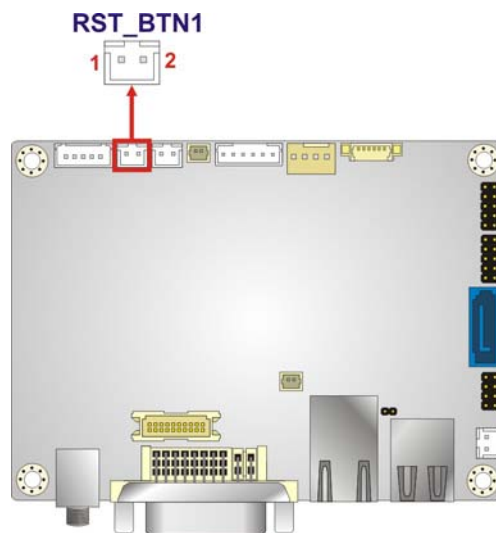

Figure 3-14: Reset Button Connector Location

Pin	Description
1	RESET+
2	RESET-

Table 3-13: Reset Button Connector Pinouts

3.2.13 RS-232 Serial Port Connector

- CN Label: COM1
- CN Type: 10-pin header
- CN Location: See **Figure 3-15**
- CN Pinouts: See **Table 3-14**

HYPER-KBN

The serial connector provides RS-232 connection.

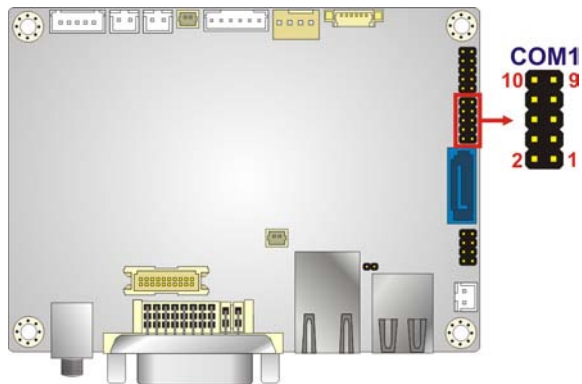

Figure 3-15: RS-232 Serial Port Connector Location

PIN NO.	DESCRIPTION	PIN NO.	DESCRIPTION
1	NDCD1	2	NDSR1
3	NRX1	4	NRTS1
5	NTX1	6	NCTS1
7	NDTR1	8	NRI1
9	GND	10	GND

Table 3-14: RS-232 Serial Port Connector Pinouts

3.2.14 SATA 6Gb/s Drive Connector

CN Label: **SATA1**

CN Type: 7-pin SATA connector

CN Location: See **Figure 3-16**

The SATA 6Gb/s drive connector is connected to a SATA 6Gb/s drive. The SATA 6Gb/s drive transfers data at speeds as high as 6Gb/s.

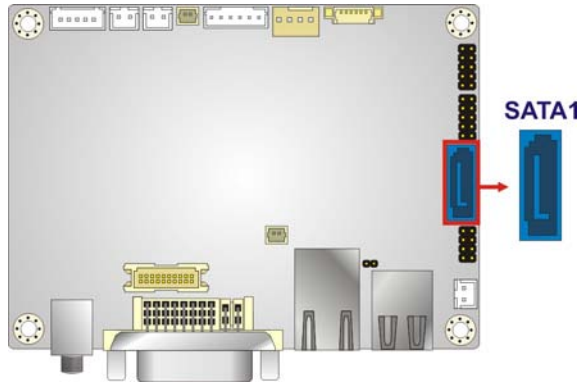

Figure 3-16: SATA 6Gb/s Drive Connector Location

3.2.15 SATA Power Connector

- CN Label: **SATA_PWR1**
- CN Type: 2-pin wafer
- CN Location: See **Figure 3-17**
- CN Pinouts: See **Table 3-15**

The SATA power connector provides +5V power output to the SATA connector.

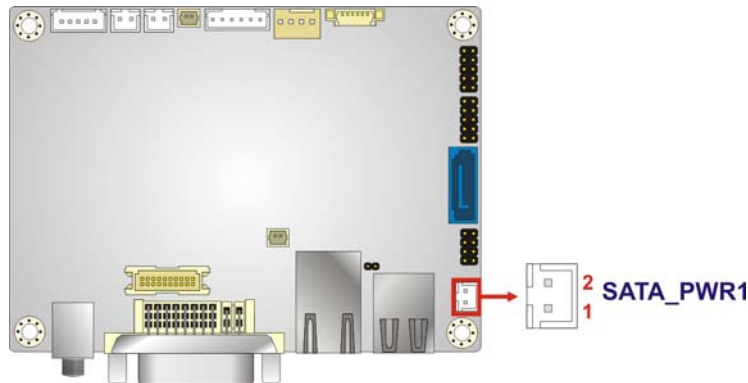

Figure 3-17: SATA Power Connector Location

PIN NO.	DESCRIPTION
1	+5V
2	GND

Table 3-15: SATA Power Connector Pinouts

HYPER-KBN

3.2.16 SPI Flash Connector

CN Label:	SPI1
CN Type:	6-pin wafer
CN Location:	See Figure 3-18
CN Pinouts:	See Table 3-16

The SPI Flash connector is used to flash the BIOS.

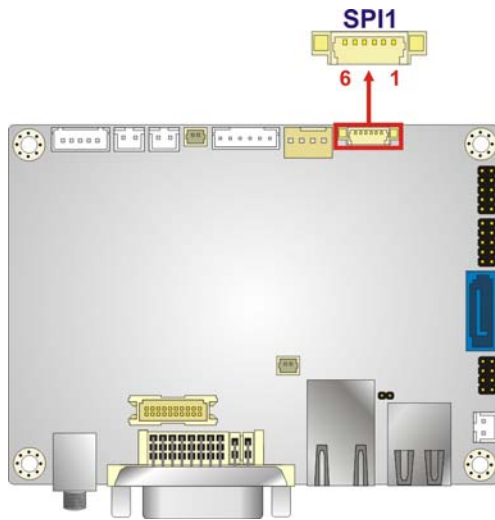

Figure 3-18: SPI Flash Connector Location

Pin	Description
1	SPI_POWER
2	SPI_CS#
3	SPI_DATAIN
4	SPI_CLK
5	SPI_DATAOUT
6	GND

Table 3-16: SPI Flash Connector Pinouts

3.2.17 System Fan Connector

CN Label:	FAN1
CN Type:	4-pin wafer

CN Location: See **Figure 3-19**

CN Pinouts: See **Table 3-17**

The fan connector attaches to a system cooling fan.

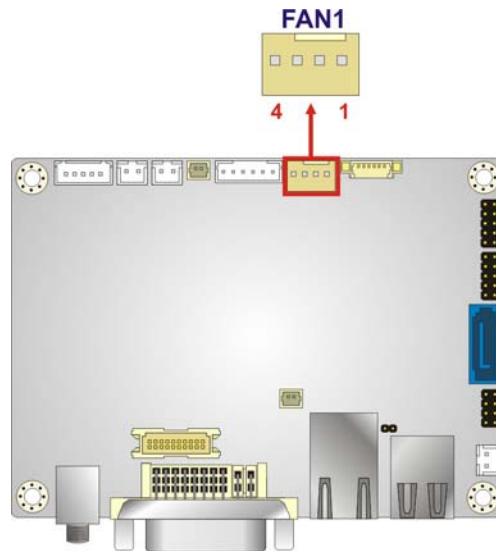

Figure 3-19: System Fan Connector Locations

PIN NO.	DESCRIPTION	PIN NO.	DESCRIPTION
1	GND	2	+12V
3	APU_FANTACH0	4	APU_FANOUT0

Table 3-17: System Fan Connector Pinouts

3.2.18 USB Connector

CN Label: **USB2**

CN Type: 8-pin header

CN Location: See **Figure 3-20**

CN Pinouts: See **Table 3-18**

The USB connector provides two USB 2.0 ports by dual-port USB cable.

HYPER-KBN

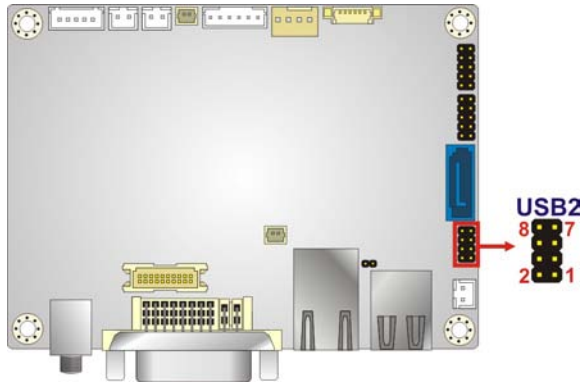

Figure 3-20: USB Connector Locations

PIN NO.	DESCRIPTION	PIN NO.	DESCRIPTION
1	USBVOL	2	GND
3	DATA0_N	4	DATA1_P
5	DATA0_P	6	DATA1_N
7	GND	8	USBVOL

Table 3-18: USB Connector Pinouts

3.3 External Peripheral Interface Connector Panel

Figure 3-21 shows the HYPER-KBN external peripheral interface connector (EPIC) panel.

The EPIC panel consists of the following:

- 1 x DVI connector
- 1 x LAN connector
- 1 x Power connector
- 2 x USB 3.0 connectors

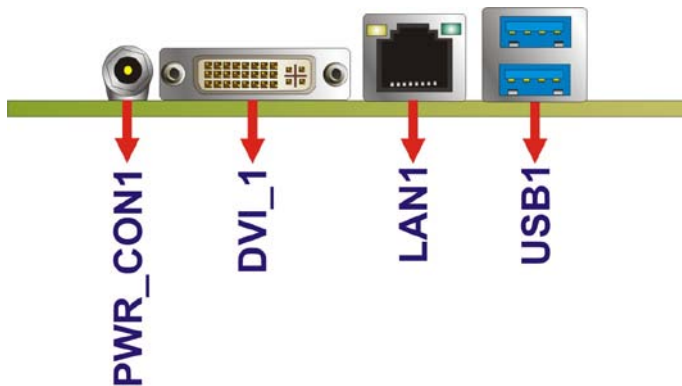

Figure 3-21: External Peripheral Interface Connector

3.3.1 DVI Connector

- CN Label: DVI_1
- CN Type: 24-pin female
- CN Location: See **Figure 3-21**
- CN Pinouts: See **Table 3-19**

The DVI (Digital Visual Interface) port connects to a monitor that supports DVI video input.

PIN NO.	DESCRIPTION	PIN NO.	DESCRIPTION
1	DDI2_LANE_NO	14	+5V_DVI
2	DDI2_LANE_P0	15	GND
3	GND	16	CON_DP1_HPDP
4	NC	17	DDI2_LANE_N2
5	NC	18	DDI2_LANE_P2
6	CON_DP1_AUXP	19	GND
7	CON_DP1_AUXN	20	NC
8	VGA_VSYNC	21	NC
9	DDI2_LANE_N1	22	GND
10	DDI2_LANE_P1	23	DDI2_LANE_P3
11	GND	24	DDI2_LANE_N3
12	NC	25	GND_DVI-I
13	NC	26	GND_DVI-I
C1	RED	C2	GREEN
C3	BLUE	C4	VGA_HSYNC
C5	GND_VGA		

Table 3-19: DVI Connector Pinouts

3.3.2 LAN Connectors

- CN Label: LAN1
- CN Type: RJ-45
- CN Location: See **Figure 3-21**

HYPER-KBN

CN Pinouts: See **Figure 3-22** and **Table 3-20**

The LAN connector connects to a local network.

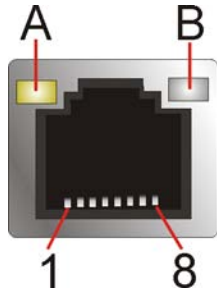

Figure 3-22: LAN Connector

Pin	Description	Pin	Description
1	MDIA3-	5	MDIA1+
2	MDIA3+	6	MDIA2+
3	MDIA2-	7	MDIA0-
4	MDIA1-	8	MDIA0+

Table 3-20: LAN Pinouts

LED	Description	LED	Description
A	on: linked blinking: data is being sent/received	B	off: 10 Mb/s green: 100 Mb/s orange: 1000 Mb/s

Table 3-21: Connector LEDs

3.3.3 Power Connectors

CN Label: PWR_CON1

CN Type: DC power jack

CN Location: See **Figure 3-21**

CN Pinouts: See **Table 3-22**

The power connector supports 12V DC power input.

PIN NO.	DESCRIPTION	PIN NO.	DESCRIPTION
1	12VIN	2	GND

PIN NO.	DESCRIPTION	PIN NO.	DESCRIPTION
3	GND		

Table 3-22: Power Connector Pinouts

3.3.4 USB Connectors

- CN Label: USB1
- CN Type: USB 3.0 ports
- CN Location: See **Figure 3-21**
- CN Pinouts: See **Table 3-22**

The HYPER-KBN has two external USB 3.0 ports. The USB 3.0 ports are for attaching USB 3.0 peripheral devices to the system. The pinouts of USB 3.0 connectors are shown below.

PIN NO.	DESCRIPTION	PIN NO.	DESCRIPTION
1	USB_3P0_VCC1	10	USB_3P0_VCC2
2	USB2P8_DM0_L	11	USB2P9_DM1_L
3	USB2P8_DP0_L	12	USB2P9_DP1_L
4	GND	13	GND
5	USB3P0_RXDN0_C	14	USB3P0_RXDN1_C
6	USB3P0_RXDP0_C	15	USB3P0_RXDP1_C
7	GND	16	GND
8	USB3P0_TXDN0_C	17	USB3P0_TXDN1_C
9	USB3P0_TXDP0_C	18	USB3P0_TXDP1_C

Table 3-23: USB 3.0 Port Pinouts

Chapter

4

Installation

4.1 Anti-static Precautions



WARNING:

Failure to take ESD precautions during the installation of the HYPER-KBN may result in permanent damage to the HYPER-KBN and severe injury to the user.

Electrostatic discharge (ESD) can cause serious damage to electronic components, including the HYPER-KBN. Dry climates are especially susceptible to ESD. It is therefore critical that whenever the HYPER-KBN or any other electrical component is handled, the following anti-static precautions are strictly adhered to.

- **Wear an anti-static wristband:** Wearing a simple anti-static wristband can help to prevent ESD from damaging the board.
- **Self-grounding:** Before handling the board, touch any grounded conducting material. During the time the board is handled, frequently touch any conducting materials that are connected to the ground.
- **Use an anti-static pad:** When configuring the HYPER-KBN, place it on an anti-static pad. This reduces the possibility of ESD damaging the HYPER-KBN.
- **Only handle the edges of the PCB:** When handling the PCB, hold the PCB by the edges.

4.2 Installation Considerations



NOTE:

The following installation notices and installation considerations should be read and understood before installation. All installation notices must be strictly adhered to. Failing to adhere to these precautions may lead to severe damage and injury to the person performing the installation.

HYPER-KBN



WARNING:

The installation instructions described in this manual should be carefully followed in order to prevent damage to the HYPER-KBN, HYPER-KBN components and injury to the user.

Before and during the installation please **DO** the following:

- Read the user manual:
 - The user manual provides a complete description of the HYPER-KBN installation instructions and configuration options.
- Wear an electrostatic discharge cuff (ESD):
 - Electronic components are easily damaged by ESD. Wearing an ESD cuff removes ESD from the body and helps prevent ESD damage.
- Place the HYPER-KBN on an antistatic pad:
 - When installing or configuring the motherboard, place it on an antistatic pad. This helps to prevent potential ESD damage.
- Turn all power to the HYPER-KBN off:
 - When working with the HYPER-KBN, make sure that it is disconnected from all power supplies and that no electricity is being fed into the system.

Before and during the installation of the HYPER-KBN **DO NOT:**

- Remove any of the stickers on the PCB board. These stickers are required for warranty validation.
- Use the product before verifying all the cables and power connectors are properly connected.
- Allow screws to come in contact with the PCB circuit, connector pins, or its components.

4.3 SO-DIMM Installation

**WARNING:**

Using incorrectly specified SO-DIMM may cause permanently damage the HYPER-KBN. Please make sure the purchased SO-DIMM complies with the memory specifications of the HYPER-KBN. SO-DIMM specifications compliant with the HYPER-KBN are listed in the specification table of Chapter 1.

To install an SO-DIMM, please follow the steps below and refer to Figure 4-1.

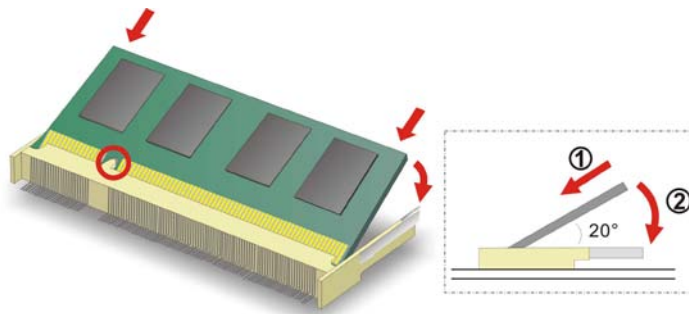

Figure 4-1: SO-DIMM Installation

- Step 1:** **Locate the SO-DIMM socket.** Place the board on an anti-static mat.
- Step 2:** **Align the SO-DIMM with the socket.** Align the notch on the memory with the notch on the memory socket.
- Step 3:** **Insert the SO-DIMM.** Push the memory in at a 20° angle. (See Figure 4-1)
- Step 4:** **Seat the SO-DIMM.** Gently push downwards and the arms clip into place. (See Figure 4-1)

HYPER-KBN

4.4 Internal Peripheral Device Connections

This section outlines the installation of peripheral devices to the on-board connectors

4.4.1 Audio Kit Installation

The Audio Kit that came with the HYPER-KBN connects to the audio connector on the HYPER-KBN. The audio kit consists of three audio jacks. Mic-in connects to a microphone. Line-in provides a stereo line-level input to connect to the output of an audio device. Line-out, a stereo line-level output, connects to two amplified speakers. To install the audio kit, please refer to the steps below:

Step 1: **Locate the audio connector.** The location of the 10-pin audio connector is shown in **Chapter 3**.

Step 2: **Align pin 1.** Align pin 1 on the on-board connector with pin 1 on the audio kit connector. Pin 1 on the audio kit connector is indicated with a white dot. See Figure 4-2.

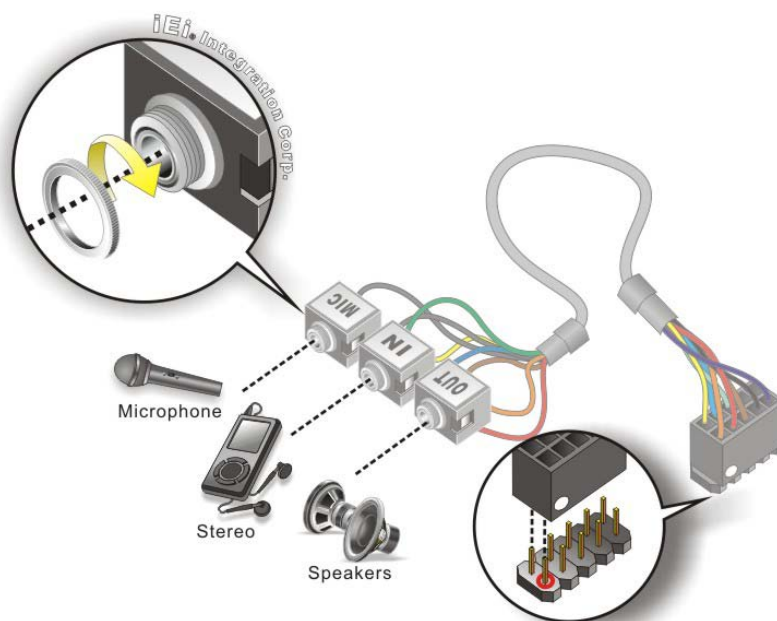

Figure 4-2: Audio Kit Cable Connection

Step 3: Connect the audio devices. Connect speakers to the line-out audio jack. Connect the output of an audio device to the line-in audio jack. Connect a microphone to the mic-in audio jack.

4.4.2 SATA Drive Connection

The HYPER-KBN is shipped with a SATA drive cable. To connect the SATA drive to the connector, please follow the steps below.

Step 1: Locate the SATA connector and the SATA power connector. The locations of the connectors are shown in **Chapter 3**.

Step 2: Insert the cable connector. Insert the cable connector into the on-board SATA drive connector and the SATA power connector. See **Figure 4-3**.

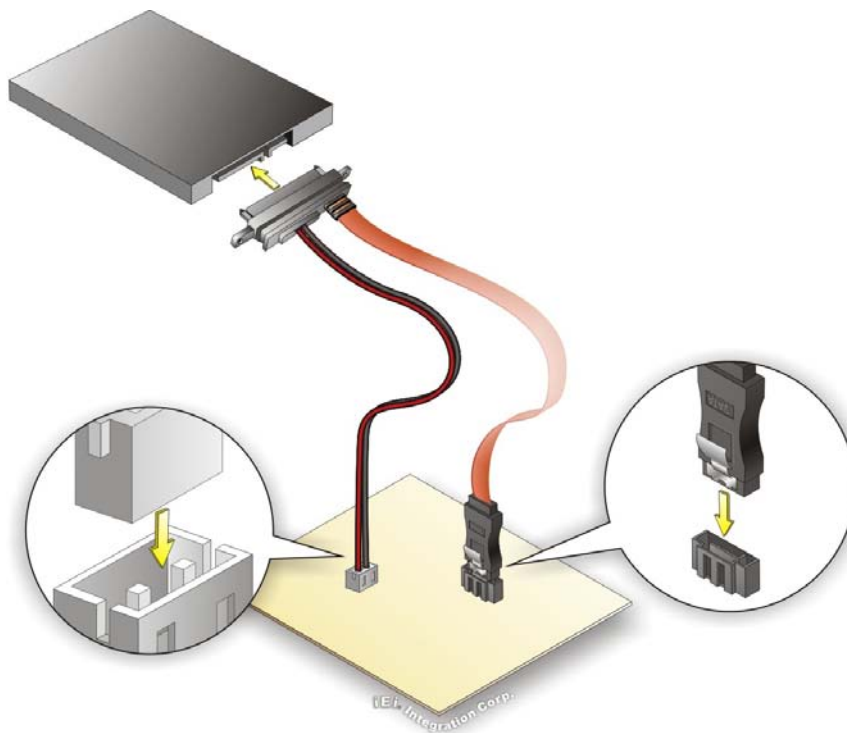

Figure 4-3: SATA Drive Cable Connection

Step 3: Connect the cable to the SATA disk. Connect the connector on the other end of the cable to the connector at the back of the SATA drive. See **Figure 4-3**.

HYPER-KBN

Step 4: To remove the SATA cable from the SATA connector, press the clip on the connector at the end of the cable.

4.4.3 Single RS-232 Cable

The single RS-232 cable consists of one serial port connector attached to a serial communications cable that is then attached to a D-sub 9 male connector. To install the single RS-232 cable, please follow the steps below.

Step 1: Locate the connector. The location of the RS-232 connector is shown in **Chapter 3**.

Step 2: Insert the cable connector. Insert the connector into the serial port box header. See Figure 4-4. A key on the front of the cable connectors ensures the connector can only be installed in one direction.

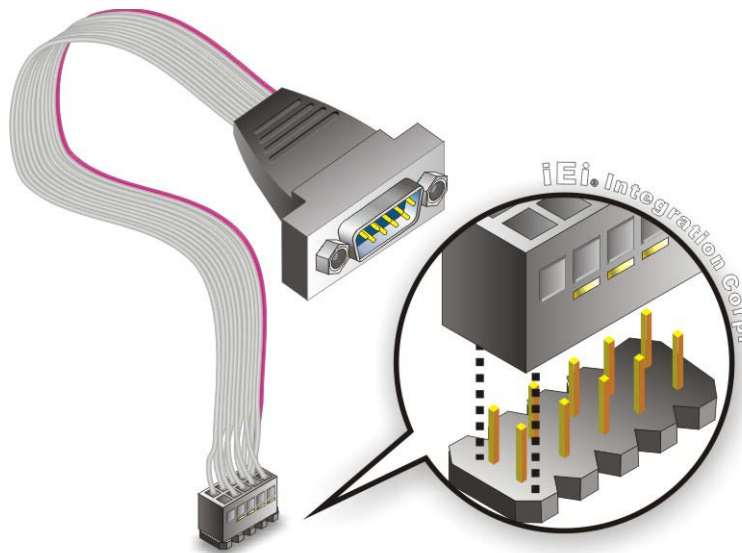

Figure 4-4: Single RS-232 Cable Installation

Step 3: Secure the bracket. The single RS-232 connector has two retention screws that must be secured to a chassis or bracket.

Step 4: Connect the serial device. Once the single RS-232 connector is connected to a chassis or bracket, a serial communications device can be connected to the system.

4.5 External Peripheral Interface Connection

The following external peripheral devices can be connected to the external peripheral interface connectors.

- DVI devices
- RJ-45 LAN cable
- USB devices

To install these devices, connect the corresponding cable connector from the actual device to the corresponding HYPER-KBN external peripheral interface connector making sure the pins are properly aligned.

4.5.1 DVI Display Device Connection

The HYPER-KBN has a single female DVI connector on the external peripheral interface panel. The DVI connector is connected to a digital display device. To connect a digital display device to the HYPER-KBN, please follow the instructions below.

Step 1: Locate the DVI connector. The location of the DVI connector is shown in **Chapter 3**.

Step 2: Align the DVI connector. Align the male DVI connector on the digital display device cable with the female DVI connector on the external peripheral interface.

Step 3: Insert the DVI connector. Once the connectors are properly aligned with the male connector, insert the male connector from the digital display device into the female connector on the HYPER-KBN. See **Figure 4-5**.

HYPER-KBN

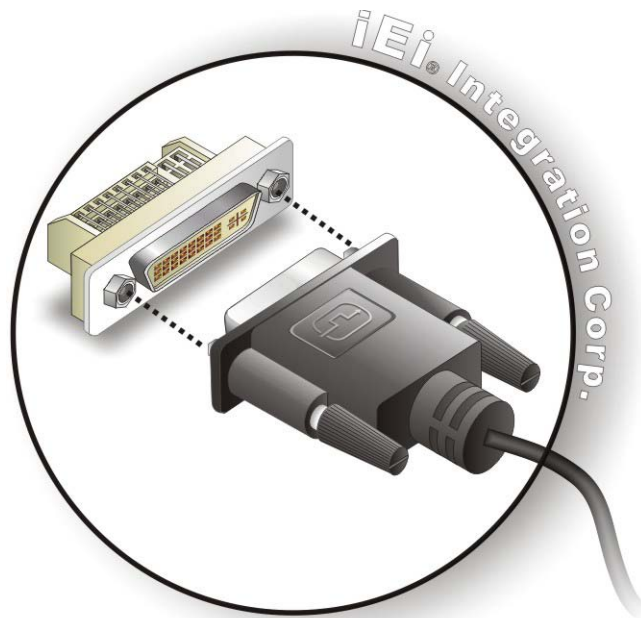

Figure 4-5: DVI Connector

Step 4: Secure the connector. Secure the DVI connector from the digital display device to the external interface by tightening the two retention screws on either side of the connector.

4.5.2 LAN Connection

There is one external RJ-45 LAN connector on the external peripheral interface panel. The RJ-45 connector enables connection to an external network. To connect a LAN cable with an RJ-45 connector, please follow the instructions below.

Step 1: Locate the RJ-45 connector. The location of the LAN connector is shown in **Chapter 3**.

Step 2: Align the connector. Align the RJ-45 connector on the LAN cable with the RJ-45 connectors on the HYPER-KBN. See **Figure 4-6**.

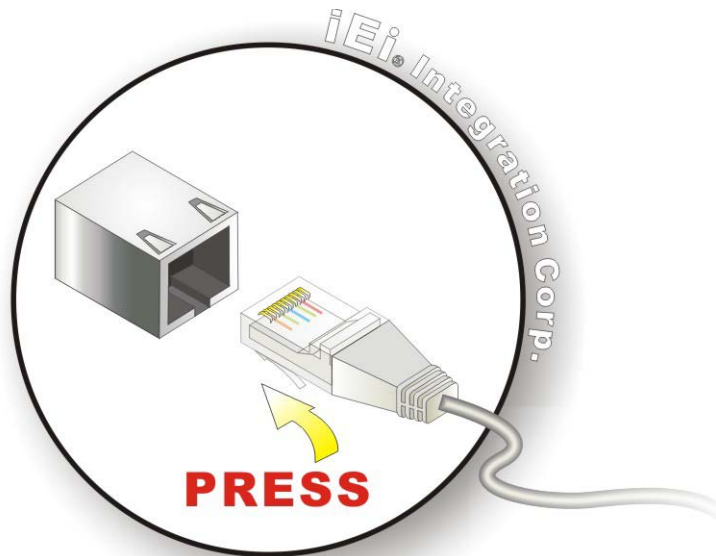

Figure 4-6: LAN Connection

Step 3: Insert the LAN cable RJ-45 connector. Once aligned, gently insert the LAN cable RJ-45 connector into the on-board RJ-45 connector.

4.5.3 USB Connection

The external USB Series "A" receptacle connectors provide easier and quicker access to external USB devices. Follow the steps below to connect USB devices to the HYPER-KBN.

Step 1: Locate the USB Series "A" receptacle connectors. The locations of the USB Series "A" receptacle connectors are shown in **Chapter 3**.

Step 2: Insert a USB Series "A" plug. Insert the USB Series "A" plug of a device into the USB Series "A" receptacle on the external peripheral interface. See **Figure 4-7**.

HYPER-KBN

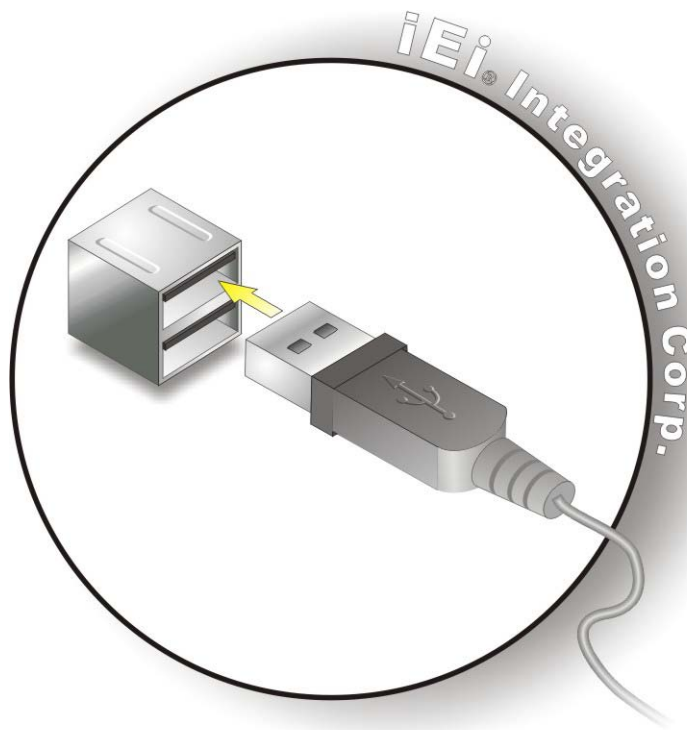

Figure 4-7: USB Connector

4.6 Heat Sink Enclosure



WARNING:

Never run the HYPER-KBN without the heat sink secured to the board. The heat sink ensures the system remains cool and does not need addition heat sinks to cool the system.

The HYPER-KBN is shipped with a specific heat sink module and four retention screws, four hex head studs and four intermediate poles. To install the heat sink module, see **Figure 4-8** below.

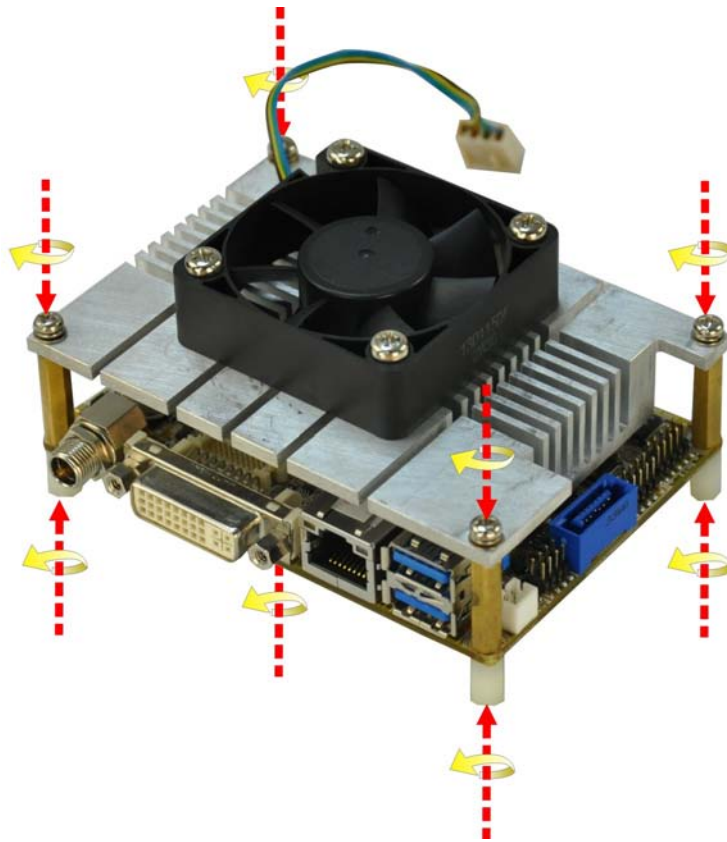

Figure 4-8: Heat Sink Retention Screws

Chapter

5

BIOS

5.1 Introduction

The BIOS is programmed onto the BIOS chip. The BIOS setup program allows changes to certain system settings. This chapter outlines the options that can be changed.



NOTE:

Some of the BIOS options may vary throughout the life cycle of the product and are subject to change without prior notice.

5.1.1 Starting Setup

The UEFI BIOS is activated when the computer is turned on. The setup program can be activated in one of two ways.

1. Press the **DELETE** or **F2** key as soon as the system is turned on or
2. Press the **DELETE** or **F2** key when the “**Press Del to enter SETUP**” message appears on the screen.

If the message disappears before the **DELETE** or **F2** key is pressed, restart the computer and try again.

5.1.2 Using Setup

Use the arrow keys to highlight items, press **ENTER** to select, use the PageUp and PageDown keys to change entries, press **F1** for help and press **ESC** to quit. Navigation keys are shown in.

Key	Function
Up arrow	Move to the item above
Down arrow	Move to the item below
Left arrow	Move to the item on the left hand side
Right arrow	Move to the item on the right hand side
+	Increase the numeric value or make changes

HYPER-KBN

Key	Function
-	Decrease the numeric value or make changes
Page up	Move to the next page
Page down	Move to the previous page
Esc	Main Menu – Quit and do not save changes into CMOS Status Page Setup Menu and Option Page Setup Menu -- Exit current page and return to Main Menu
F1	General help, only for Status Page Setup Menu and Option Page Setup Menu
F9	Load optimized defaults
F10	Save changes and Exit BIOS

Table 5-1: BIOS Navigation Keys

5.1.3 Getting Help

When **F1** is pressed a small help window describing the appropriate keys to use and the possible selections for the highlighted item appears. To exit the Help Window press **Esc** or the **F1** key again.

5.1.4 Unable to Reboot after Configuration Changes

If the computer cannot boot after changes to the system configuration is made, CMOS defaults. Use the jumper described in Chapter 3.

5.1.5 BIOS Menu Bar

The **menu bar** on top of the BIOS screen has the following main items:

- Main – Changes the basic system configuration.
- Advanced – Changes the advanced system settings.
- Chipset – Changes the chipset settings.
- Boot – Changes the system boot configuration.
- Security – Sets User and Supervisor Passwords.
- Save & Exit – Selects exit options and loads default settings

The following sections completely describe the configuration options found in the menu items at the top of the BIOS screen and listed above.

5.2 Main

The **Main** BIOS menu (**BIOS Menu 1**) appears when the **BIOS Setup** program is entered. The **Main** menu gives an overview of the basic system information.

```

Aptio Setup Utility - Copyright (C) 2012 American Megatrends, Inc.
Main  Advanced  Chipset  Boot  Security  Save & Exit

BIOS Information
BIOS Vendor                American Megatrends
Core Version                4.6.5.4
Compliancy                 UEFI 2.3.1; PI 1.2
Project Version            SA99AR05.rom
Build Date and Time        08/28/2013 16:46:14

System Date                 [Fri 08/30/2013]
System Time                 [19:43:27]

Access Level                Administrator

Set the Date. Use Tab to
switch between Data
elements.

-----
<->: Select Screen
^ v: Select Item
Enter>Select
+/-: Change Opt.
F1:  General Help
F2:  Previous Values
F3:  Optimized Defaults
F4:  Save & Exit
ESC: Exit

Version 2.15.1236. Copyright (C) 2012 American Megatrends, Inc.
    
```

BIOS Menu 1: Main

→ BIOS Information

The **BIOS Information** lists a brief summary of the BIOS. The fields in **BIOS Information** cannot be changed. The items shown in the system overview include:

- **BIOS Vendor:** Installed BIOS vendor
- **Core Version:** Current BIOS version
- **Compliancy:** Current compliant version
- **Project Version:** the board version
- **Build Date and Time:** Date the current BIOS version was made

The System Overview field also has two user configurable fields:

HYPER-KBN

➔ System Date [xx/xx/xx]

Use the **System Date** option to set the system date. Manually enter the day, month and year.

➔ System Time [xx:xx:xx]

Use the **System Time** option to set the system time. Manually enter the hours, minutes and seconds.

5.3 Advanced

Use the **Advanced** menu (**BIOS Menu 2**) to configure the CPU and peripheral devices through the following sub-menus:



WARNING!

Setting the wrong values in the sections below may cause the system to malfunction. Make sure that the settings made are compatible with the hardware.

```

Aptio Setup Utility - Copyright (C) 2012 American Megatrends, Inc.
Main  Advanced  Chipset  Boot  Security  Save & Exit
-----
> ACPI Settings
> RTC Wake Settings
> CPU Configuration
> IDE Configuration
> USB Configuration
> F81216 Super IO Configuration
> Serial Port Console Redirection

System ACPI Parameters.
-----
<->: Select Screen
↑ ↓: Select Item
Enter>Select
F1  General Help
F2  Previous Values
F3  Optimized Defaults
F4  Save
ESC Exit

Version 2.15.1236. Copyright (C) 2012 American Megatrends, Inc.
    
```

BIOS Menu 2: Advanced

5.3.1 ACPI Settings

The **ACPI Settings** menu (**BIOS Menu 3**) configures the Advanced Configuration and Power Interface (ACPI) options.

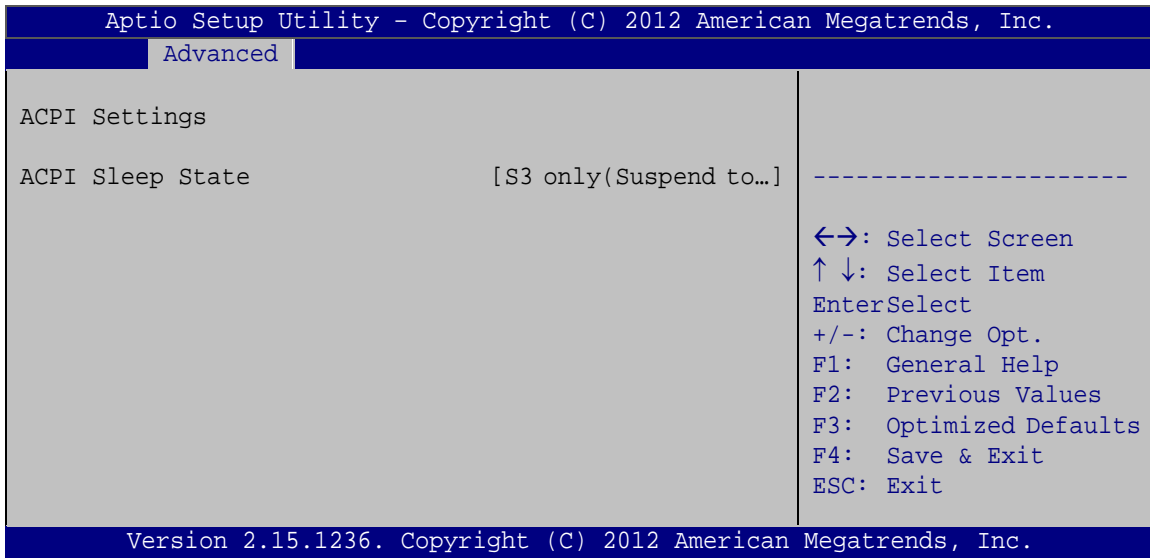

BIOS Menu 3: ACPI Configuration

→ ACPI Sleep State [S3 only (Suspend to RAM)]

The fields in **ACPI Sleep State** option cannot be changed.

- **S3 only (Suspend to RAM)** **DEFAULT** The caches are flushed and the CPU is powered off. Power to the RAM is maintained. The computer returns slower to a working state, but more power is saved.

5.3.2 RTC Wake Settings

The **RTC Wake Settings** menu (**BIOS Menu 4**) configures RTC wake event.

HYPER-KBN

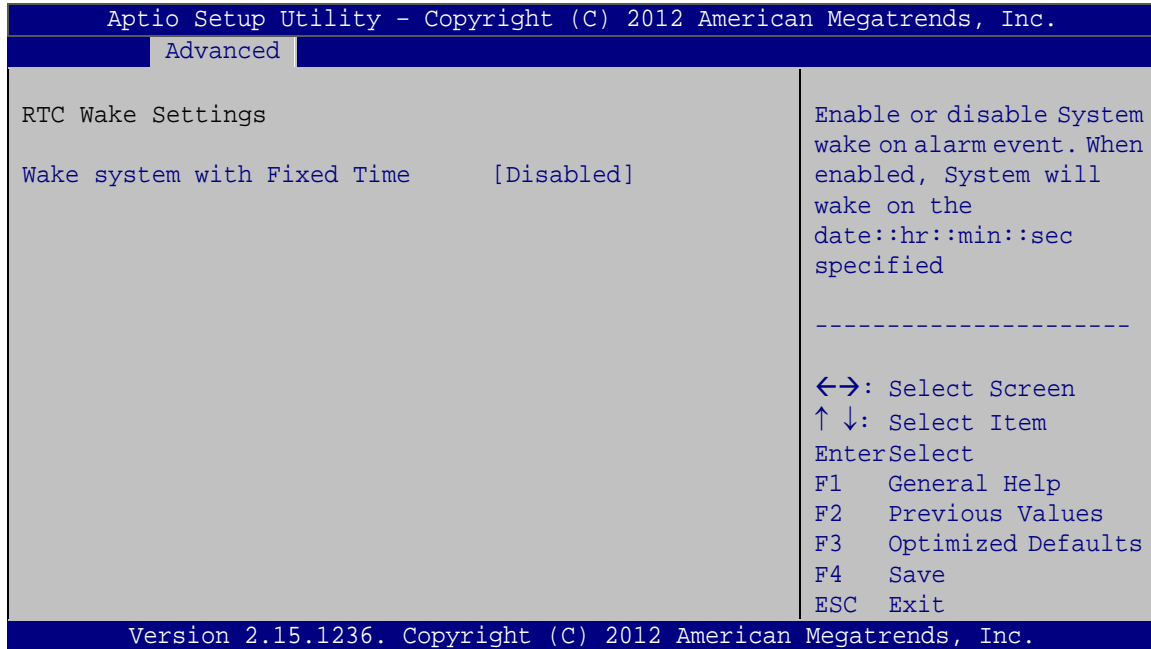

BIOS Menu 4: RTC Wake Settings

→ Wake system with Fixed Time [Disabled]

Use the **Wake system with Fixed Time** option to enable or disable the system wake on alarm event.

→ **Disabled** **DEFAULT** The real time clock (RTC) cannot generate a wake event

→ **Enabled** If selected, the **Wake up every day** option appears allowing you to enable to disable the system to wake every day at the specified time. Besides, the following options appear with values that can be selected:

Wake up date

Wake up hour

Wake up minute

Wake up second

After setting the alarm, the computer turns itself on from a suspend state when the alarm goes off.

5.3.3 CPU Configuration

Use the **CPU Configuration** menu (**BIOS Menu 5**) to view detailed CPU specifications and configure the CPU.

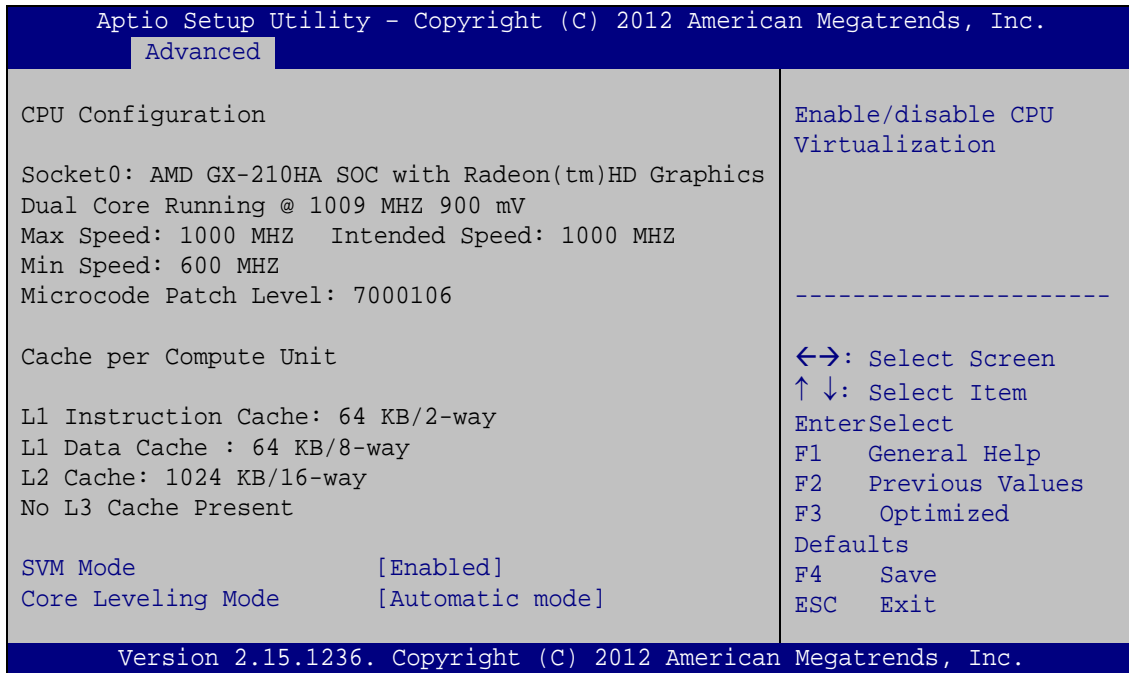

BIOS Menu 5: CPU Configuration

➔ SVM Mode [Enabled]

Use the **SVM Mode** option to enable or disable the CPU virtualization function.

- ➔ **Disabled** Disables the CPU virtualization function
- ➔ **Enabled** **DEFAULT** Enables the CPU virtualization function

➔ Core Leveling Mode [Automatic mode]

Use the **Core Leveling Mode** option to configure the number of the active processor cores.

- ➔ **Automatic mode** **DEFAULT** Active the processor cores by automatic mode

HYPER-KBN

- ➔ **Three cores per processor** Active three of the processor cores
- ➔ **Two cores per processor** Active two of the processor cores
- ➔ **One core per processor** Active one of the processor cores

5.3.4 IDE Configuration

Use the **IDE Configuration** menu (**BIOS Menu 6**) to change and/or set the configuration of the SATA devices installed in the system.

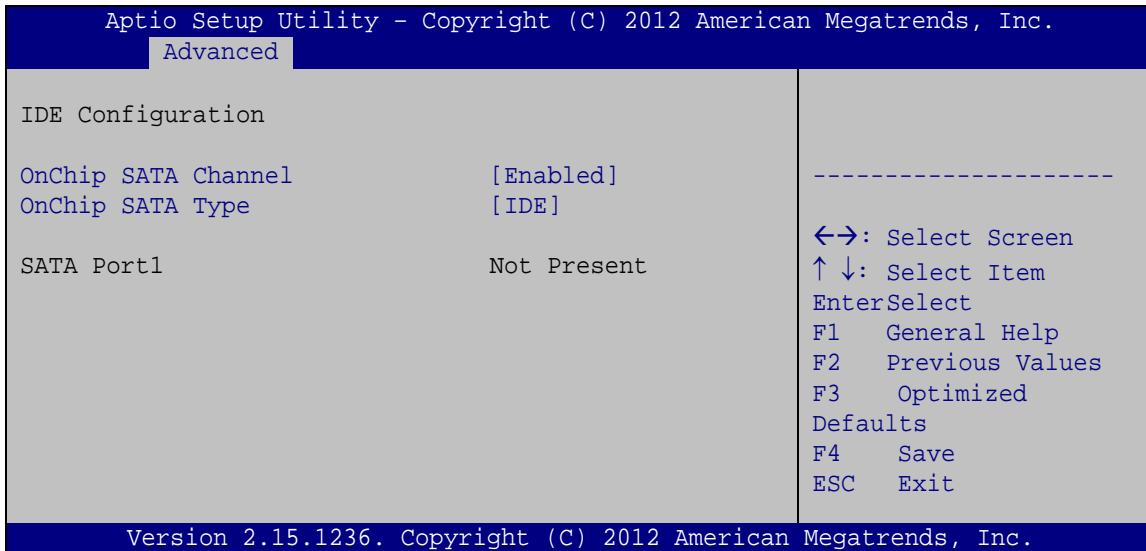

BIOS Menu 6: IDE Configuration

- ➔ OnChip SATA Channel [Enabled]

Use the **OnChip SATA Channel** option to configure Onchip SATA channel.

- ➔ **Disabled** Disables Onchip SATA channel.
- ➔ **Enabled** **DEFAULT** Enables Onchip SATA channel.

- ➔ OnChip SATA Type [IDE]

Use the **OnChip SATA Type** option to configure Onchip SATA type.

- ➔ **IDE** **DEFAULT** Configures SATA devices as normal IDE device.
- ➔ **AHCI** Configures SATA devices as AHCI device.

5.3.5 USB Configuration

Use the **USB Configuration** menu (**BIOS Menu 7**) to read USB configuration information and configure the USB settings.

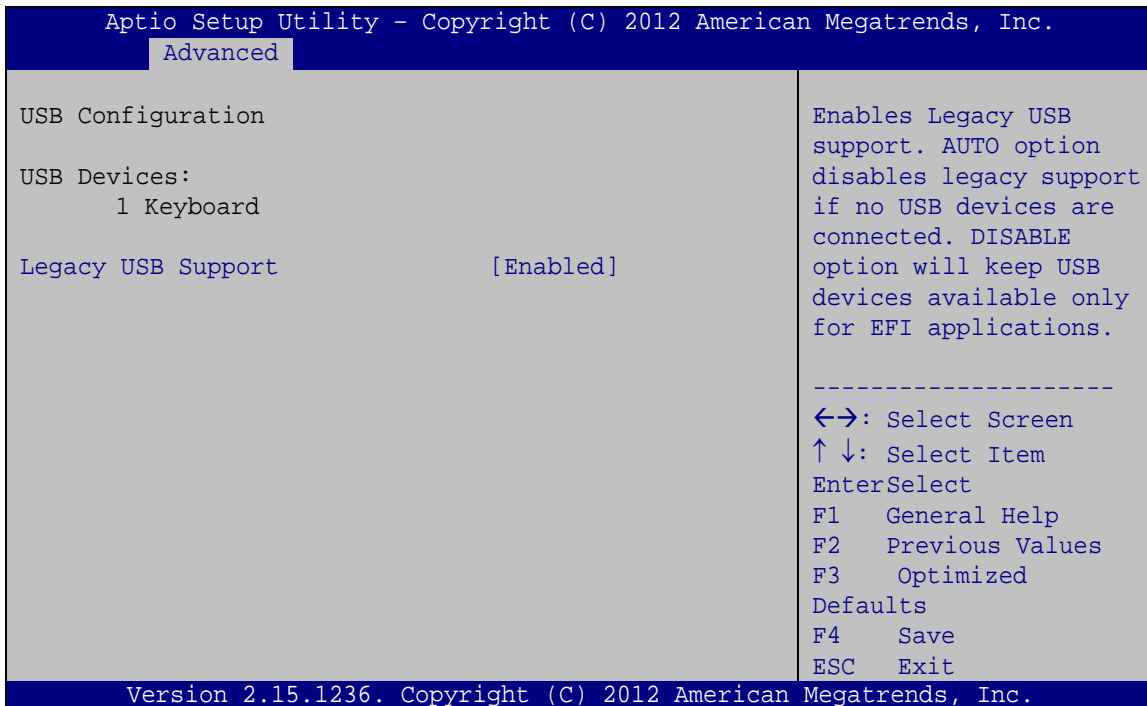

BIOS Menu 7: USB Configuration

- ➔ USB Devices

The **USB Devices Enabled** field lists the USB devices that are enabled on the system

- ➔ Legacy USB Support [Enabled]

Use the **Legacy USB Support** BIOS option to enable USB mouse and USB keyboard support. Normally if this option is not enabled, any attached USB mouse or USB keyboard does not become available until a USB compatible operating system is fully booted with all USB drivers loaded. When this option is enabled, any attached USB mouse or USB

HYPER-KBN

keyboard can control the system even when there is no USB driver loaded onto the system.

- ➔ **Enabled** **DEFAULT** Legacy USB support enabled
- ➔ **Disabled** Legacy USB support disabled
- ➔ **Auto** Legacy USB support disabled if no USB devices are connected

5.3.6 F81216 Super IO Configuration

Use the **F81216 Super IO Configuration** menu (**BIOS Menu 8**) to set or change the configurations for the serial ports.

```

Aptio Setup Utility - Copyright (C) 2012 American Megatrends, Inc.
  Advanced
F81216 Super IO Configuration
Super IO Chip                      Fintek F81216
> F81216 Serial Port 1 Configuration
Set Parameters of Serial Port 1 (COMA)
-----
<=>: Select Screen
↑ ↓: Select Item
EnterSelect
F1    General Help
F2    Previous Values
F3    Optimized Defaults
F4    Save
ESC   Exit
Version 2.15.1236. Copyright (C) 2012 American Megatrends, Inc.
  
```

BIOS Menu 8: Super IO Configuration

5.3.6.1 Serial Port 1 Configuration

Use the **Serial Port 1 Configuration** menu (**BIOS Menu 13**) to configure the serial port 1.

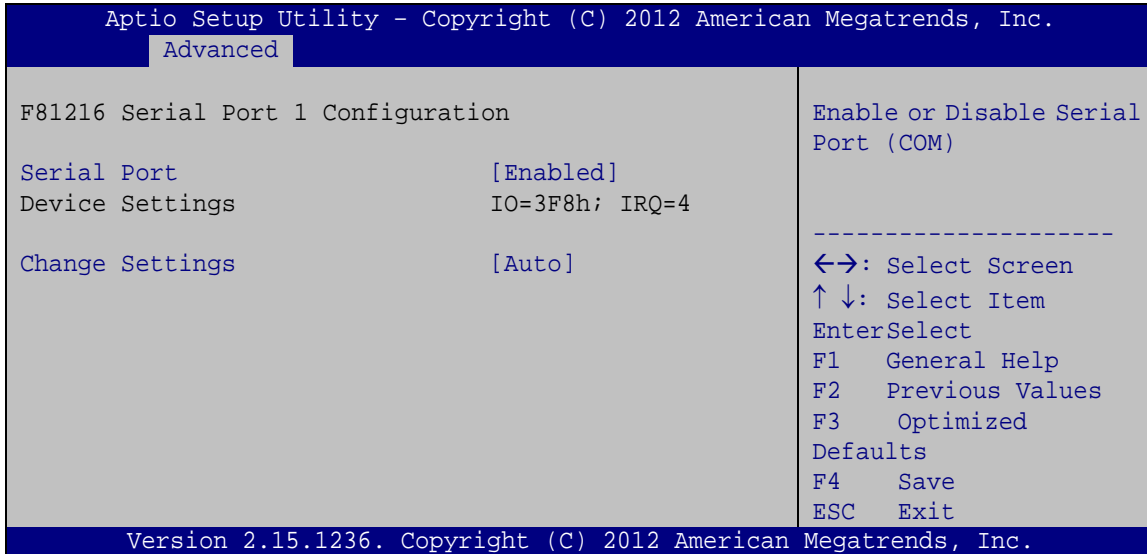

BIOS Menu 9: Serial Port 1 Configuration Menu

➔ Serial Port [Enabled]

Use the **Serial Port** option to enable or disable the serial port.

- ➔ **Disabled** Disable the serial port
- ➔ **Enabled** **DEFAULT** Enable the serial port

➔ Change Settings [Auto]

Use the **Change Settings** option to change the serial port IO port address and interrupt address.

- ➔ **Auto** **DEFAULT** The serial port IO port address and interrupt address are automatically detected.
- ➔ **IO=3F8h; IRQ=4** Serial Port I/O port address is 3F8h and the interrupt address is IRQ4
- ➔ **IO=3F8h; IRQ=3, 4,5,6,7,10,11,12** Serial Port I/O port address is 3F8h and the interrupt address is IRQ3,4,5,6,7,10,11,12

HYPER-KBN

- | | |
|--|--|
| <ul style="list-style-type: none"> ➔ IO=2F8h; IRQ=3, 4,5,6,7,10,11,12 ➔ IO=3E8h; IRQ=3, 4,5,6,7,10,11,12 ➔ IO=2E8h; IRQ=3, 4,5,6,7,10,11,12 | <p>Serial Port I/O port address is 2F8h and the interrupt address is IRQ3,4,5,6,7,10,11,12</p> <p>Serial Port I/O port address is 3E8h and the interrupt address is IRQ3,4,5,6,7,10,11,12</p> <p>Serial Port I/O port address is 2E8h and the interrupt address is IRQ3,4,5,6,7,10,11,12</p> |
|--|--|

5.3.7 Serial Port Console Redirection

The **Serial Port Console Redirection** menu (**BIOS Menu 10**) allows the console redirection options to be configured. Console redirection allows users to maintain a system remotely by re-directing keyboard input and text output through the serial port.

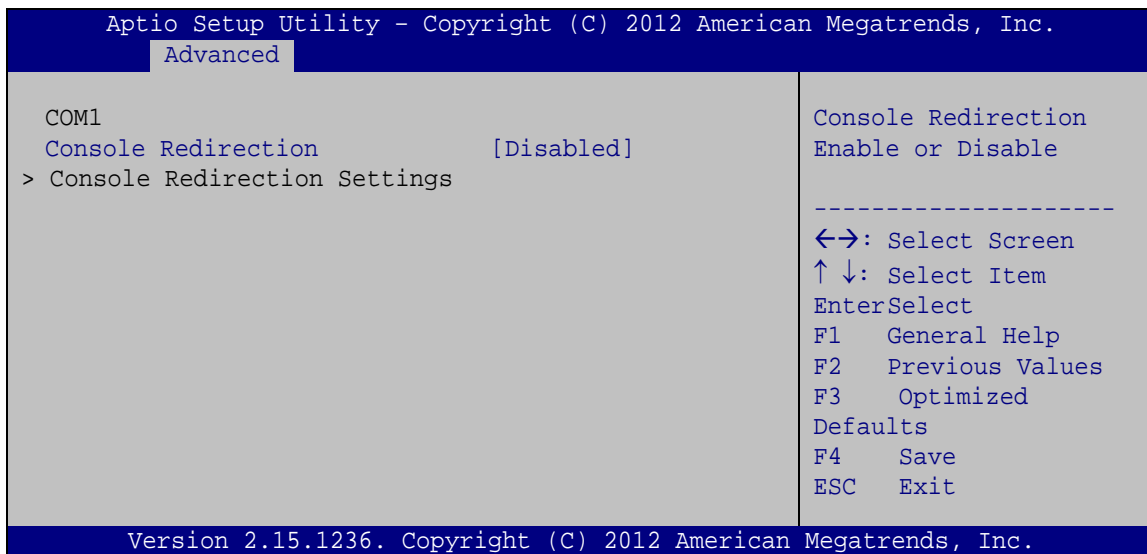

BIOS Menu 10: Serial Port Console Redirection

- ➔ Console Redirection [Disabled]

Use **Console Redirection** option to enable or disable the console redirection function.

- | | |
|---|---|
| <ul style="list-style-type: none"> ➔ Disabled ➔ Enabled | <p>DEFAULT Disabled the console redirection function</p> <p>Enabled the console redirection function</p> |
|---|---|

5.3.7.1 Console Redirection Settings

The **Console Redirection Settings** menu (**BIOS Menu 11**) allows the console redirection options to be configured. The option is active when Console Redirection option is enabled.

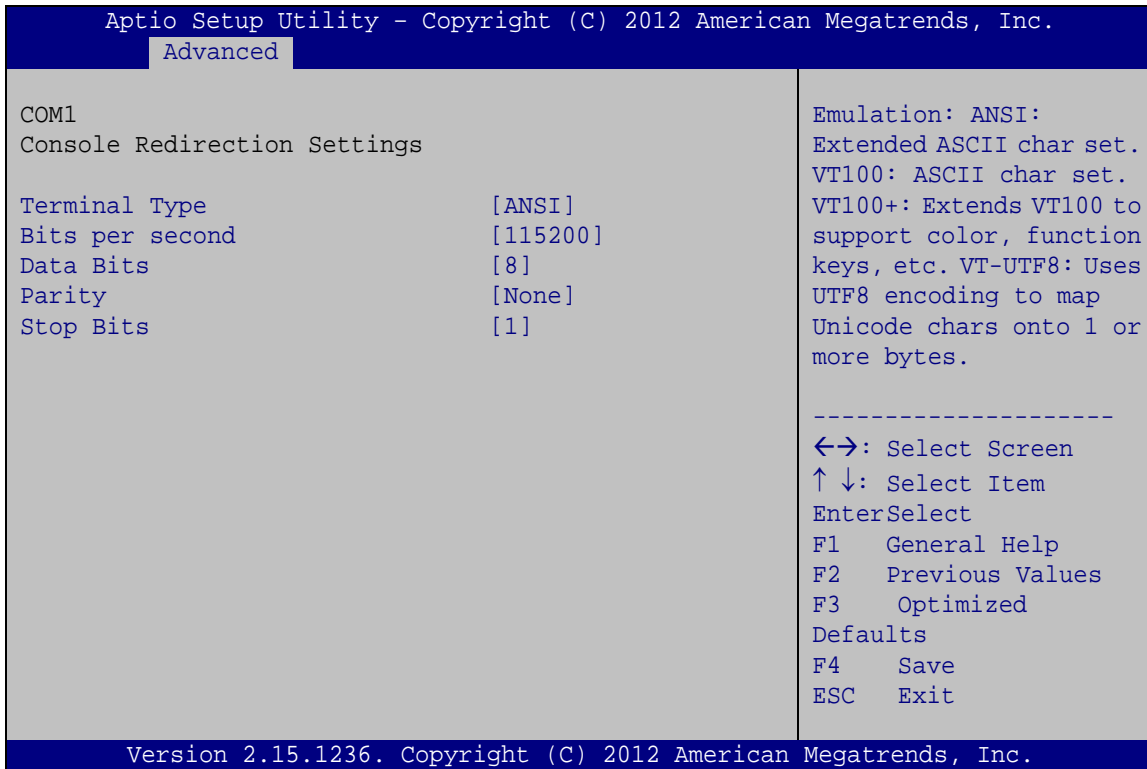

BIOS Menu 11: Console Redirection Settings

➔ Terminal Type [ANSI]

Use the **Terminal Type** option to specify the remote terminal type.

- ➔ **VT100** The target terminal type is VT100
- ➔ **VT100+** The target terminal type is VT100+
- ➔ **VT-UTF8** The target terminal type is VT-UTF8
- ➔ **ANSI** **DEFAULT** The target terminal type is ANSI

HYPER-KBN

→ Bits per second [115200]

Use the **Bits per second** option to specify the serial port transmission speed. The speed must match the other side. Long or noisy lines may require lower speeds.

- | | | | |
|---|---------------|----------------|--|
| → | 9600 | | Sets the serial port transmission speed at 9600. |
| → | 19200 | | Sets the serial port transmission speed at 19200. |
| → | 38400 | | Sets the serial port transmission speed at 38400. |
| → | 57600 | | Sets the serial port transmission speed at 57600. |
| → | 115200 | DEFAULT | Sets the serial port transmission speed at 115200. |

→ Data Bits [8]

Use the **Data Bits** option to specify the number of data bits.

- | | | | |
|---|----------|----------------|--------------------------|
| → | 7 | | Sets the data bits at 7. |
| → | 8 | DEFAULT | Sets the data bits at 8. |

→ Parity [None]

Use the **Parity** option to specify the parity bit that can be sent with the data bits for detecting the transmission errors.

- | | | | |
|---|--------------|----------------|---|
| → | None | DEFAULT | No parity bit is sent with the data bits. |
| → | Even | | The parity bit is 0 if the number of ones in the data bits is even. |
| → | Odd | | The parity bit is 0 if the number of ones in the data bits is odd. |
| → | Mark | | The parity bit is always 1. This option does not provide error detection. |
| → | Space | | The parity bit is always 0. This option does not provide error detection. |

➔ Stop Bits [1]

Use the **Stop Bits** option to specify the number of stop bits used to indicate the end of a serial data packet. Communication with slow devices may require more than 1 stop bit.

- ➔ 1 **DEFAULT** Sets the number of stop bits at 1.
- ➔ 2 Sets the number of stop bits at 2.

5.4 Chipset

Use the **Chipset** menu (**BIOS Menu 18**) to access the PCH-IO and System Agent (SA) configuration menus.



WARNING!

Setting the wrong values for the Chipset BIOS selections in the Chipset BIOS menu may cause the system to malfunction.

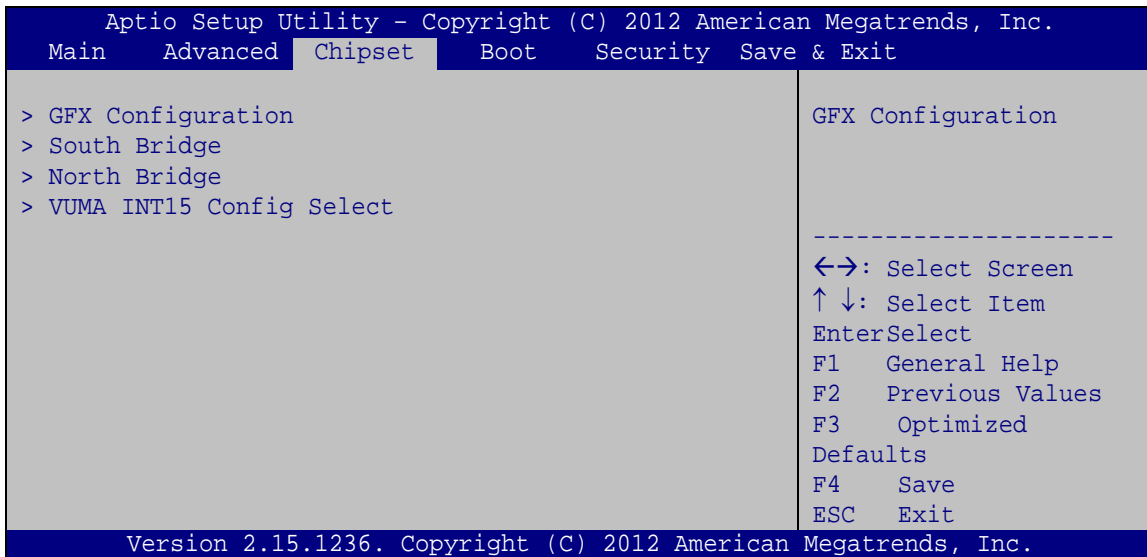

BIOS Menu 12: Chipset

HYPER-KBN

5.4.1 GFX Configuration

Use the **GFX Configuration** menu (**BIOS Menu 13**) to configure the video device connected to the system.

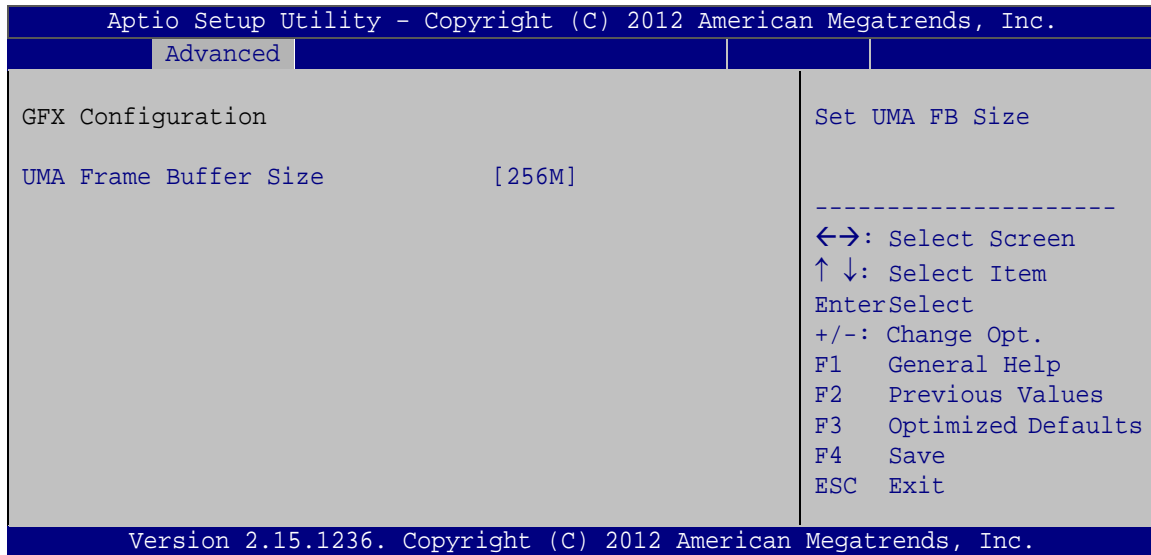

BIOS Menu 13: GFX Configuration

→ UMA Frame Buffer Size [256M]

Use the **UMA Frame Buffer** option to specify the amount of system memory that can be allocated as graphics memory. Configuration options are listed below.

- 32M
- 64M
- 128M
- 256M **DEFAULT**
- 512M

5.4.2 South Bridge Configuration

Use the **South Bridge Configuration** menu (**BIOS Menu 14**) to configure the South Bridge chipset.

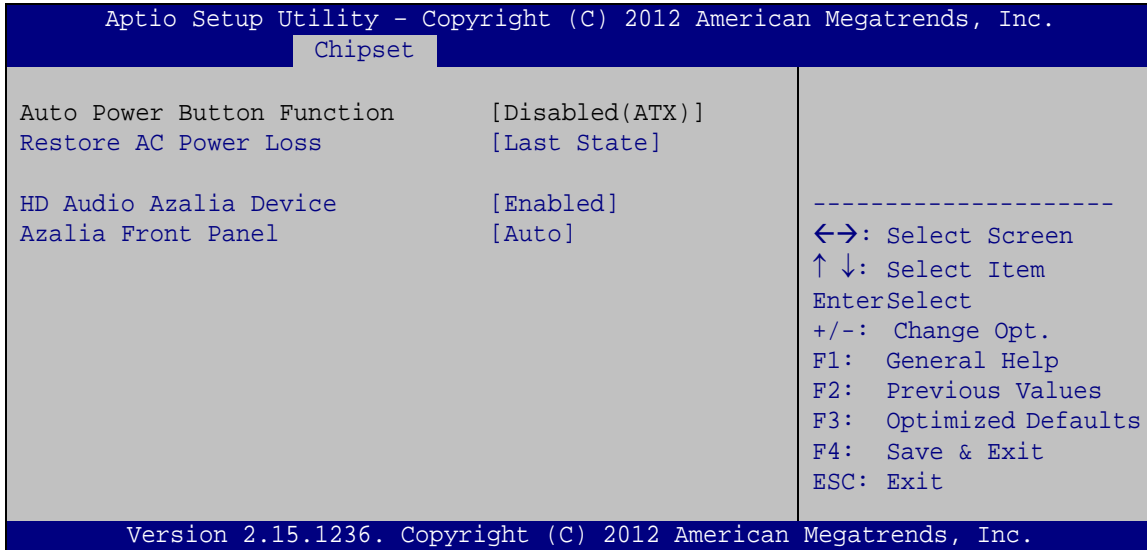

BIOS Menu 14: South Bridge Configuration

➔ Restore AC Power Loss [Last State]

Use the **Restore on AC Power Loss** option to specify what state the system returns to if there is a sudden loss of power to the system.

- ➔ **Power On** The system turns on
- ➔ **Power Off** The system remains turned off
- ➔ **Last State** **DEFAULT** The system returns to its previous state. If it was on, it turns itself on. If it was off, it remains off.

➔ HD Audio Azalia Device [Enabled]

Use the **HD Audio Azalia Device** option to enable or disable the High Definition Audio controller.

- ➔ **Auto** The onboard High Definition Audio controller will be enabled if present, disabled otherwise.
- ➔ **Disabled** The onboard High Definition Audio controller is disabled
- ➔ **Enabled** **DEFAULT** The onboard High Definition Audio controller is detected automatically and enabled

HYPER-KBN

→ Azalia Front Panel [Enabled]

Use the **Azalia Front Panel** option to enable or disable the front panel audio controller.

- **Auto** The front panel audio controller will be enabled if present, disabled otherwise.
- **Disabled** The front panel audio controller is disabled
- **Enabled** **DEFAULT** The front panel audio controller is detected automatically and enabled

5.4.3 North Bridge Configuration

Use the **North Bridge** menu (**BIOS Menu 17**) to configure the North Bridge chipset.

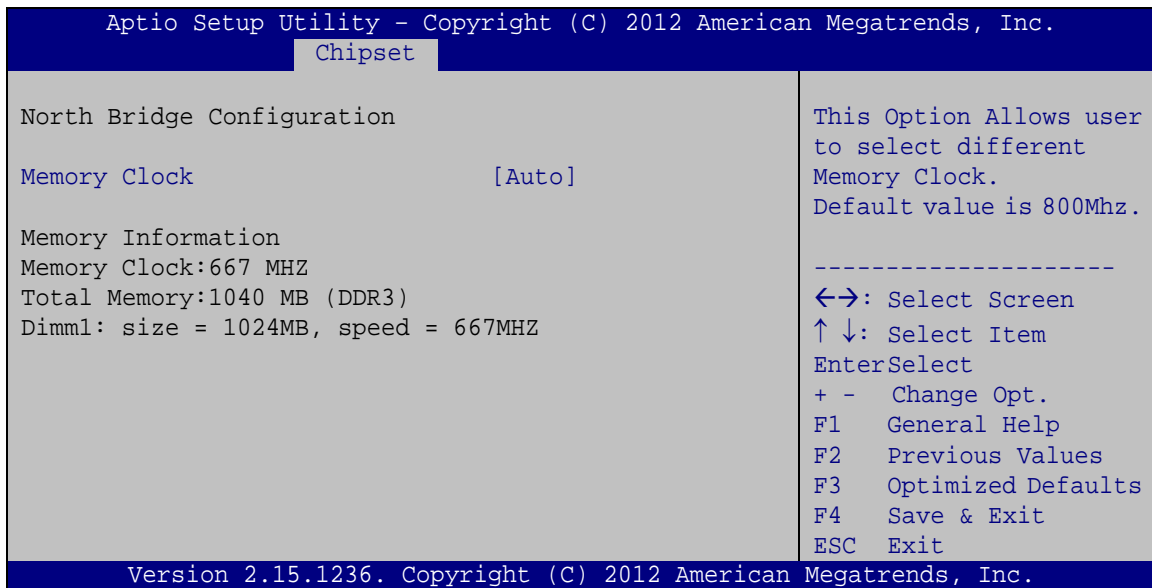

BIOS Menu 15: North Bridge Configuration

→ Memory Clock [Auto]

Use the **Memory Clock** option to select different memory clock. Configuration options are listed below:

- Auto **DEFAULT**
- 800MHZ
- 1066MHZ

- 1333MHZ
- 1600MHZ
- 1866MHZ

5.4.4 VUMA INT15 Config Select

Use the **VUMA INT15 Config Select** menu (**BIOS Menu 16**) to configure the video device connected to the system.

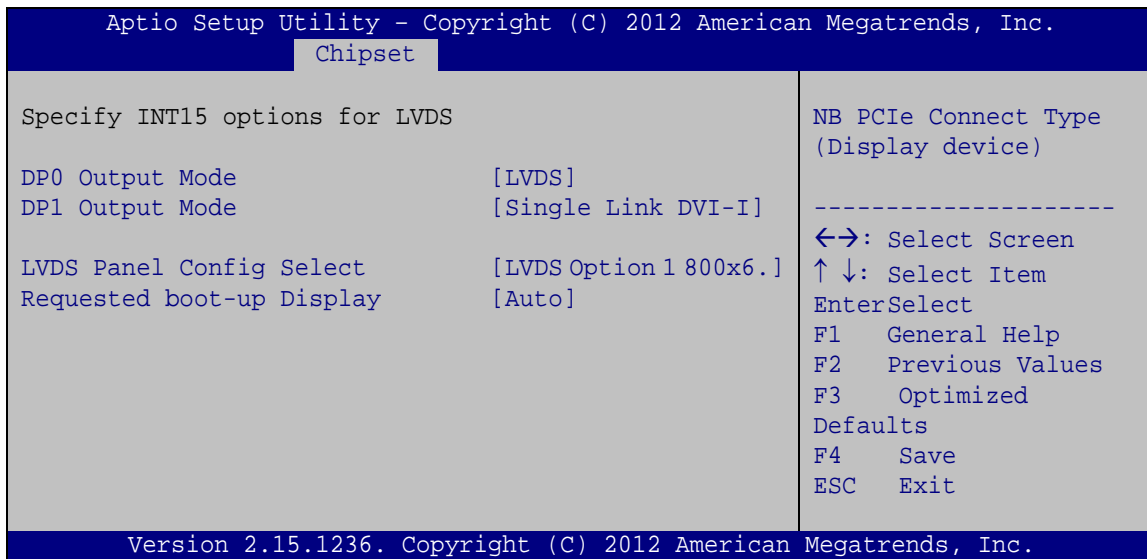

BIOS Menu 16: VUMA INT15 Configuration

➔ DP0 Output Mode [LVDS]

Use the **DP0 Output Mode** BIOS option to enable or disable LVDS.

- ➔ **LVDS** **DEFAULT** LVDS is enabled
- ➔ **Disabled** LVDS is disabled

➔ DP1 Output Mode [Single Link DVI-I]

Use the **DP1 Output Mode** BIOS option to enable or disable DVI-I.

- ➔ **Single Link DVI-I** **DEFAULT** DVI-I is enabled
- ➔ **Disabled** DVI-I is disabled

HYPER-KBN

➔ LVDS Panel Config Select [LVDS Option 1 800x600]

Use the **LVDS Panel Config Select** BIOS option to select the type of flat panel connected to the system. Configuration options are listed below.

- LVDS Option 1 800x600 **DEFAULT**
- LVDS Option 2 1024x768
- LVDS Option 3 1280x720
- LVDS Option 4 1280x800
- LVDS Option 5 1280x1024
- LVDS Option 6 1366x768
- LVDS Option 7 1440x900
- LVDS Option 8 1600x900
- LVDS Option 8 1920x1024

➔ Request boot-up Display [Auto]

Use the **Request boot-up Display** BIOS option to select the display device used by the system when it boots. Configuration options are listed below.

- Auto **DEFAULT**
- CRT Only
- LCD Only
- DPP Only
- CRT and LCD
- CRT and DFP

5.5 Boot

Use the **Boot** menu (**BIOS Menu 17**) to configure system boot options.

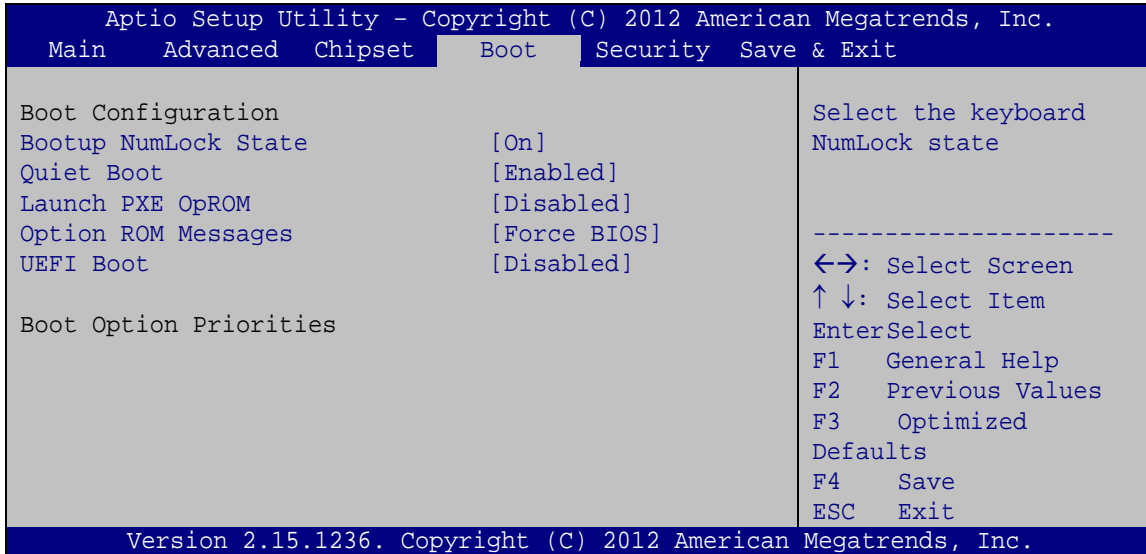

BIOS Menu 17: Boot

➔ Bootup NumLock State [On]

Use the **Bootup NumLock State** BIOS option to specify if the number lock setting must be modified during boot up.

➔ **On** **DEFAULT** Allows the Number Lock on the keyboard to be enabled automatically when the computer system boots up. This allows the immediate use of the 10-key numeric keypad located on the right side of the keyboard. To confirm this, the Number Lock LED light on the keyboard is lit.

➔ **Off** Does not enable the keyboard Number Lock automatically. To use the 10-keys on the keyboard, press the Number Lock key located on the upper left-hand corner of the 10-key pad. The Number Lock LED on the keyboard lights up when the Number Lock is engaged.

HYPER-KBN

→ Quiet Boot [Enabled]

Use the **Quiet Boot** BIOS option to select the screen display when the system boots.

- **Disabled** Normal POST messages displayed
- **Enabled** **DEFAULT** OEM Logo displayed instead of POST messages

→ Launch PXE OpROM [Disabled]

Use the **Launch PXE OpROM** option to enable or disable boot option for legacy network devices.

- **Disabled** **DEFAULT** Ignore all PXE Option ROMs
- **Enabled** Load PXE Option ROMs.

→ Option ROM Messages [Force BIOS]

Use the **Option ROM Messages** option to set the Option ROM display mode.

- **Force BIOS** **DEFAULT** Sets display mode to force BIOS.
- **Keep Current** Sets display mode to current.

→ UEFI Boot [Disabled]

Use the **UEFI Boot** option to enable or disable to boot from the UEFI devices.

- **Auto** If the first boot HDD is GPT then enable UEFI boot options, otherwise disable,
- **Enabled** Boot from UEFI devices is enabled.
- **Disabled** **DEFAULT** Boot from UEFI devices is disabled.

➔ **Boot Option Priority**

Use the **Boot Option Priority** function to set the system boot sequence from the available devices. The drive sequence also depends on the boot sequence in the individual device section.

5.6 Security

Use the **Security** menu (**BIOS Menu 18**) to set system and user passwords.

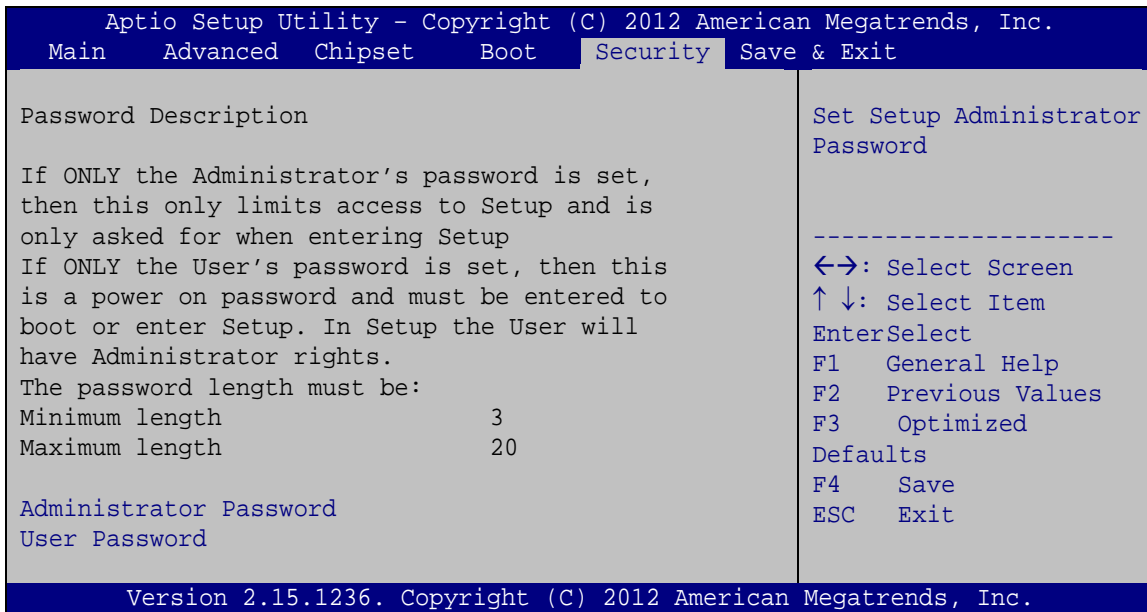

BIOS Menu 18: Security

➔ **Administrator Password**

Use the **Administrator Password** to set or change a administrator password.

➔ **User Password**

Use the **User Password** to set or change a user password.

5.7 Exit

Use the **Exit** menu (**BIOS Menu 19**) to load default BIOS values, optimal failsafe values and to save configuration changes.

HYPER-KBN

```

Aptio Setup Utility - Copyright (C) 2012 American Megatrends, Inc.
Main   Advanced   Chipset   Boot   Security   Save & Exit
-----
Save Changes and Reset
Discard Changes and Reset

Restore Defaults
Save as User Defaults
Restore User Defaults

-----
<->: Select Screen
↑ ↓: Select Item
Enter>Select
F1   General Help
F2   Previous Values
F3   Optimized
Defaults
F4   Save
ESC  Exit

Version 2.15.1236. Copyright (C) 2012 American Megatrends, Inc.

```

BIOS Menu 19:Exit

→ Save Changes and Reset

Use the **Save Changes and Reset** option to save the changes made to the BIOS options and to exit the BIOS configuration setup program.

→ Discard Changes and Reset

Use the **Discard Changes and Reset** option to exit the system without saving the changes made to the BIOS configuration setup program.

→ Restore Defaults

Use the **Restore Defaults** option to load the optimal default values for each of the parameters on the Setup menus. **F3 key can be used for this operation.**

→ Save as User Defaults

Use the **Save as User Defaults** option to save the changes done so far as user defaults.

→ Restore User Defaults

Use the **Restore User Defaults** option to restore the user defaults to all the setup options.

Appendix

A

BIOS Menu Options

HYPER-KBN

➔ BIOS Information	50
➔ System Date [xx/xx/xx]	51
➔ System Time [xx:xx:xx]	51
➔ ACPI Sleep State [S3 only (Suspend to RAM)]	52
➔ Wake system with Fixed Time [Disabled].....	53
➔ SVM Mode [Enabled]	54
➔ Core Leveling Mode [Automatic mode]	54
➔ OnChip SATA Channel [Enabled].....	55
➔ OnChip SATA Type [IDE]	55
➔ USB Devices	56
➔ Legacy USB Support [Enabled].....	56
➔ Serial Port [Enabled].....	58
➔ Change Settings [Auto]	58
➔ Console Redirection [Disabled].....	59
➔ Terminal Type [ANSI].....	60
➔ Bits per second [115200].....	61
➔ Data Bits [8]	61
➔ Parity [None].....	61
➔ Stop Bits [1]	62
➔ UMA Frame Buffer Size [256M].....	63
➔ Restore AC Power Loss [Last State]	64
➔ HD Audio Azalia Device [Enabled]	64
➔ Azalia Front Panel [Enabled]	65
➔ Memory Clock [Auto].....	65
➔ DP0 Output Mode [LVDS].....	66
➔ DP1 Output Mode [Single Link DVI-I].....	66
➔ LVDS Panel Config Select [LVDS Option 1 800x600]	67
➔ Request boot-up Display [Auto].....	67
➔ Bootup NumLock State [On].....	68
➔ Quiet Boot [Enabled]	69
➔ Launch PXE OpROM [Disabled]	69
➔ Option ROM Messages [Force BIOS].....	69
➔ UEFI Boot [Disabled]	69
➔ Boot Option Priority.....	70

- ➔ Administrator Password70
- ➔ User Password70
- ➔ Save Changes and Reset71
- ➔ Discard Changes and Reset71
- ➔ Restore Defaults71
- ➔ Save as User Defaults71
- ➔ Restore User Defaults71

Appendix

B

One Key Recovery

B.1 One Key Recovery Introduction

The IEI one key recovery is an easy-to-use front end for the Norton Ghost system backup and recovery tool. This tool provides quick and easy shortcuts for creating a backup and reverting to that backup or reverting to the factory default settings.



NOTE:

The latest One Key Recovery software provides an auto recovery function that allows a system running Microsoft Windows OS to automatically restore from the factory default image after encountering a Blue Screen of Death (BSoD) or a hang for around 10 minutes. Please refer to Section B.3 for the detailed setup procedure.

The IEI One Key Recovery tool menu is shown below.

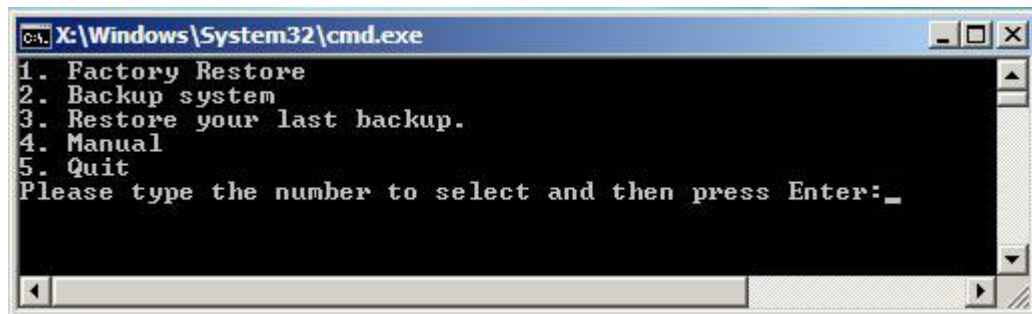

Figure B-1: IEI One Key Recovery Tool Menu

Prior to using the IEI One Key Recovery tool (as shown in **Figure B-1**) to backup or restore Windows system, five setup procedures are required.

1. Hardware and BIOS setup (see **Section B.2.1**)
2. Create partitions (see **Section B.2.2**)
3. Install operating system, drivers and system applications (see **Section B.2.3**)
4. Build the recovery partition (see **Section B.2.4**)
5. Create factory default image (see **Section B.2.5**)

HYPER-KBN

After completing the five initial setup procedures as described above, users can access the recovery tool by pressing <F3> while booting up the system. The detailed information of each function is described in **Section B.5**.



NOTE:

The initial setup procedures for Linux system are described in **Section B.3**.

B.1.1 System Requirement



NOTE:

The recovery CD can only be used with IEI products. The software will fail to run and a warning message will appear when used on non-IEI hardware.



To create the system backup, the main storage device must be split into two partitions (three partitions for Linux). The first partition will be for the operating system, while the second partition will be invisible to the operating system and contain the backup made by the one key recovery software.

The partition created for recovery images must be big enough to contain both the factory default image and the user backup image. The size must be calculated before creating the

partitions. Please take the following table as a reference when calculating the size of the partition.

	OS	OS Image after Ghost	Compression Ratio
Windows® 7	7 GB	5 GB	70%
Windows® XPE	776 MB	560 MB	70%
Windows® CE 6.0	36 MB	28 MB	77%

**NOTE:**

Specialized tools are required to change the partition size if the operating system is already installed.

B.1.2 Supported Operating System

The recovery CD is compatible with both Microsoft Windows and Linux operating systems (OS). The supported OS versions are listed below.

- Microsoft Windows
 - Windows XP (Service Pack 2 or 3 required)
 - Windows Vista
 - Windows 7
 - Windows CE 5.0
 - Windows CE 6.0
 - Windows XP Embedded
- Linux
 - Fedora Core 12 (Constantine)
 - Fedora Core 11 (Leonidas)
 - Fedora Core 10 (Cambridge)
 - Fedora Core 8 (Werewolf)
 - Fedora Core 7 (Moonshine)
 - RedHat RHEL-5.4
 - RedHat 9 (Ghirke)

HYPER-KBN

- Ubuntu 8.10 (Intrepid)
- Ubuntu 7.10 (Gutsy)
- Ubuntu 6.10 (Edgy)
- Debian 5.0 (Lenny)
- Debian 4.0 (Etch)
- SuSe 11.2
- SuSe 10.3



NOTE:

Installing unsupported OS versions may cause the recovery tool to fail.

B.2 Setup Procedure for Windows

Prior to using the recovery tool to backup or restore, a few setup procedures are required.

Step 1: Hardware and BIOS setup (see **Section B.2.1**)

Step 2: Create partitions (see **Section B.2.2**)

Step 3: Install operating system, drivers and system applications (see **Section B.2.3**)

Step 4: Build the recovery partition (see **Section B.2.4**) or build the auto recovery partition (see **Section B.3**)

Step 5: Create factory default image (see **Section B.2.5**)

The detailed descriptions are described in the following sections.



NOTE:

The setup procedures described below are for Microsoft Windows operating system users. For Linux, most of the setup procedures are the same except for several steps described in **Section B.3**.

B.2.1 Hardware and BIOS Setup

- Step 1:** Make sure the system is powered off and unplugged.
- Step 2:** Install a hard drive or SSD in the system. An unformatted and unpartitioned disk is recommended.
- Step 3:** Connect an optical disk drive to the system and insert the recovery CD.
- Step 4:** Turn on the system.
- Step 5:** Press the <DELETE> key as soon as the system is turned on to enter the BIOS.
- Step 6:** Select the connected optical disk drive as the 1st boot device. (**Boot → Boot Device Priority → 1st Boot Device**).
- Step 7:** Save changes and restart the computer. Continue to the next section for instructions on partitioning the internal storage.

B.2.2 Create Partitions

To create the system backup, the main storage device must be split into two partitions (three partitions for Linux). The first partition will be for the operating system, while the second partition will be invisible to the operating system and contain the backup made by the one key recovery software.

- Step 1:** Put the recovery CD in the optical drive of the system.
- Step 2:** **Boot the system from recovery CD.** When prompted, press any key to boot from the recovery CD. It will take a while to launch the recovery tool. Please be patient!

HYPER-KBN

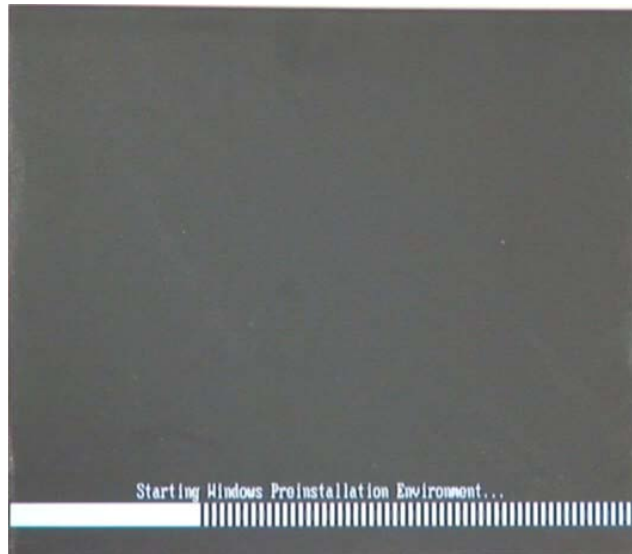

Figure B-2: Launching the Recovery Tool

Step 3: The recovery tool setup menu is shown as below.

```
C:\WINDOWS\system32\cmd.exe

1.Execute Ghost
2.Manual Recovery environment For Windows
3.Manual Recovery environment For Linux
4.Auto Recovery environment For Windows
5.Exit
6.Command Prompt
Type the number to print text.
```

Figure B-3: Recovery Tool Setup Menu

Step 4: Press <6> then <Enter>.

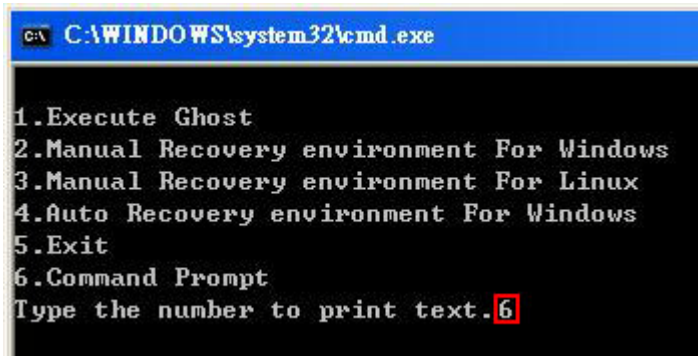

```
C:\WINDOWS\system32\cmd.exe

1.Execute Ghost
2.Manual Recovery environment For Windows
3.Manual Recovery environment For Linux
4.Auto Recovery environment For Windows
5.Exit
6.Command Prompt
Type the number to print text. 6
```

Figure B-4: Command Prompt

Step 5: The command prompt window appears. Type the following commands (marked in red) to create two partitions. One is for the OS installation; the other is for saving recovery files and images which will be an invisible partition. (Press <Enter> after entering each line below)

```
system32>diskpart
DISKPART>list vol
DISKPART>sel disk 0
DISKPART>create part pri size= ____
DISKPART>assign letter=N
DISKPART>create part pri size= ____
DISKPART>assign letter=F
DISKPART>exit
system32>format N: /fs:ntfs /q /y
system32>format F: /fs:ntfs /q /v:Recovery /y
system32>exit
```

HYPER-KBN

```

X:\I386\SYSTEM32\CMD.EXE
X:\I386\SYSTEM32>diskpart → Starts the Microsoft disk partitioning tool.

Microsoft DiskPart version 5.2.3790.1830
Copyright (C) 1999-2001 Microsoft Corporation.
On computer: MININT-JUC

DISKPART> list vol → Show partition information

   Volume ###  Ltr  Label          Fs          Type          Size         Status       Info
   -----
   Volume 0          X  CD_ROM         CDFS        DUD-ROM       405 MB       Healthy      Boot
   Volume 1          D                FAT32        Removeable   3854 MB       Healthy

DISKPART> sel disk 0 → Select a disk
Disk 0 is now the selected disk.

DISKPART> create part pri size=2000 → Create partition 1 and assign a size.
This partition is for OS installation.
DiskPart succeeded in creating the specified partition.

DISKPART> assign letter=N → Assign partition 1 a code name (N).
DiskPart successfully assigned the drive letter or mount point.

DISKPART> create part pri size=1800 → Create partition 2 and assign a size.
This partition is for recovery images.
DiskPart succeeded in creating the specified partition.

DISKPART> assign letter=F → Assign partition 2 a code name (F).
DiskPart successfully assigned the drive letter or mount point.

DISKPART> exit → Exit diskpart

X:\I386\SYSTEM32>format n: /fs:ntfs /q /y → Format partition 1 (N) as NTFS format.
The type of the file system is RAW.
The new file system is NTFS.
QuickFormatting 2000M
Creating file system structures.
Format complete.
 2048254 KB total disk space.
 2035620 KB are available.

X:\I386\SYSTEM32>format f: /fs:ntfs /q /v:Recovery /y → Formate partition 2 (F) as NTFS formate and
name it as "Recovery".
The type of the file system is RAW.
The new file system is NTFS.
QuickFormatting 1804M
Creating file system structures.
Format complete.
 1847474 KB total disk space.
 1835860 KB are available.

X:\I386\SYSTEM32>exit → Exit Windows PE

```

Figure B-5: Partition Creation Commands

**NOTE:**

Use the following commands to check if the partitions were created successfully.

```
X:\I386\SYSTEM32>diskpart
Microsoft DiskPart version 5.2.3790.1830
Copyright (C) 1999-2001 Microsoft Corporation.
On computer: MININT-JUC

DISKPART> sel disk 0
Disk 0 is now the selected disk.

DISKPART> list part

   Partition ###   Type              Size              Offset
-----
   Partition 1     Primary            2000 MB           32 KB
   Partition 2     Primary            1804 MB          2000 MB

DISKPART> exit
```

Step 6: Press any key to exit the recovery tool and automatically reboot the system.

Please continue to the following procedure: Build the Recovery Partition.

B.2.3 Install Operating System, Drivers and Applications

Install the operating system onto the unlabelled partition. The partition labeled "Recovery" is for use by the system recovery tool and should not be used for installing the operating system or any applications.

**NOTE:**

The operating system installation program may offer to reformat the chosen partition. DO NOT format the partition again. The partition has already been formatted and is ready for installing the new operating system.

To install the operating system, insert the operating system installation CD into the optical drive. Restart the computer and follow the installation instructions.

HYPER-KBN

B.2.4 Building the Recovery Partition

- Step 1:** Put the recover CD in the optical drive.
- Step 2:** Start the system.
- Step 3:** **Boot the system from the recovery CD.** When prompted, press any key to boot from the recovery CD. It will take a while to launch the recovery tool. Please be patient!

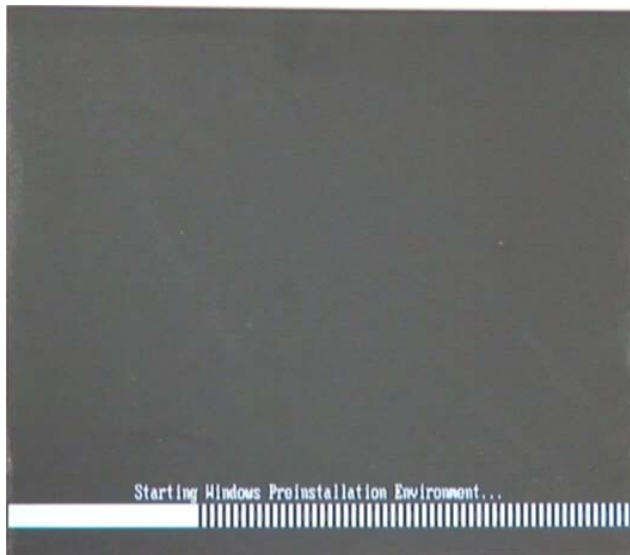

Figure B-6: Launching the Recovery Tool

- Step 4:** When the recovery tool setup menu appears, press <2> then <Enter>.

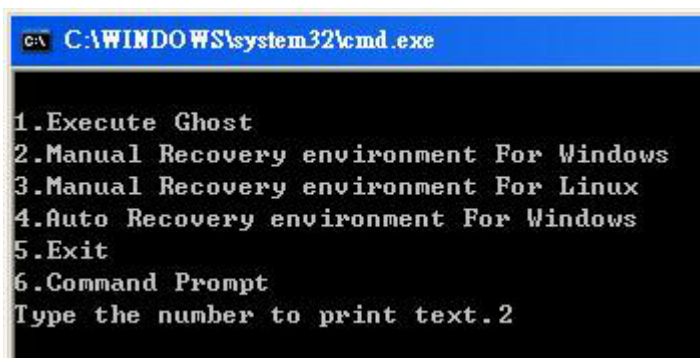

Figure B-7: Manual Recovery Environment for Windows

Step 5: The Symantec Ghost window appears and starts configuring the system to build a recovery partition. In this process the partition created for recovery files in **Section B.2.2** is hidden and the recovery tool is saved in this partition.

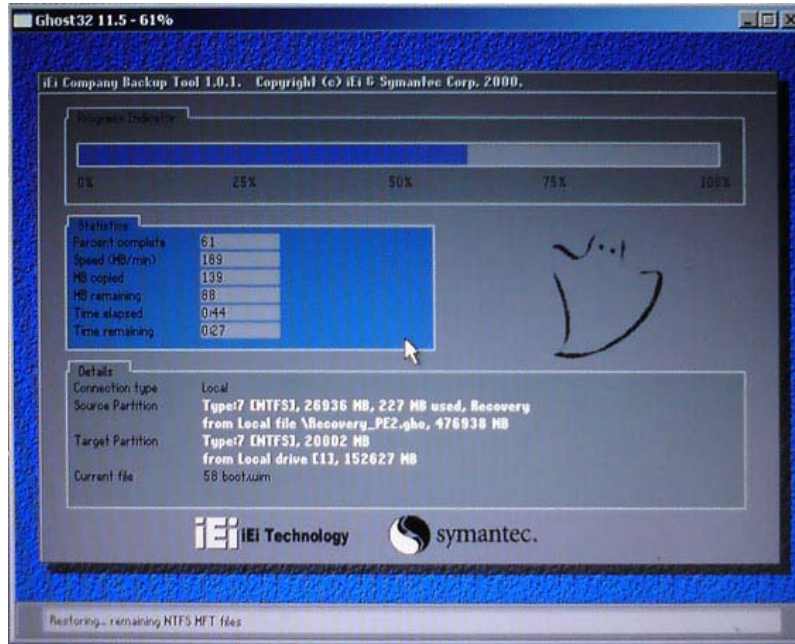

Figure B-8: Building the Recovery Partition

Step 6: After completing the system configuration, press any key in the following window to reboot the system.

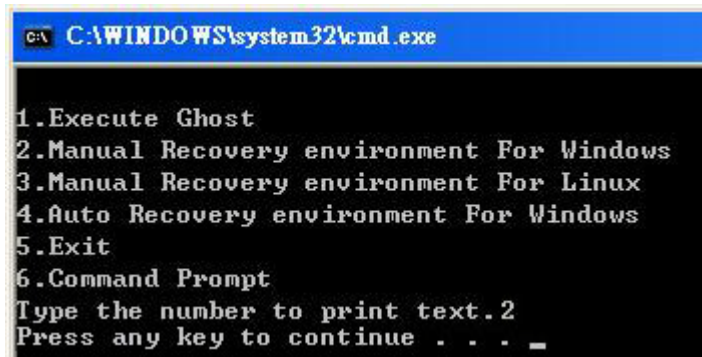

Figure B-9: Press Any Key to Continue

Step 7: Eject the recovery CD.

HYPER-KBN

B.2.5 Create Factory Default Image



NOTE:

Before creating the factory default image, please configure the system to a factory default environment, including driver and application installations.

To create a factory default image, please follow the steps below.

Step 1: Turn on the system. When the following screen displays (**Figure B-10**), press the <F3> key to access the recovery tool. The message will display for 10 seconds, please press F3 before the system boots into the operating system.

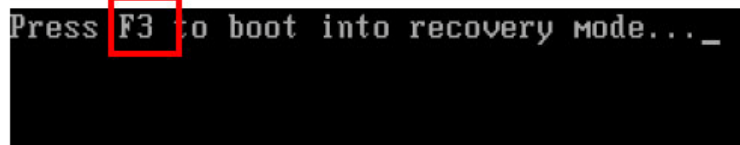

Figure B-10: Press F3 to Boot into Recovery Mode

Step 2: The recovery tool menu appears. Type <4> and press <Enter>. (**Figure B-11**)

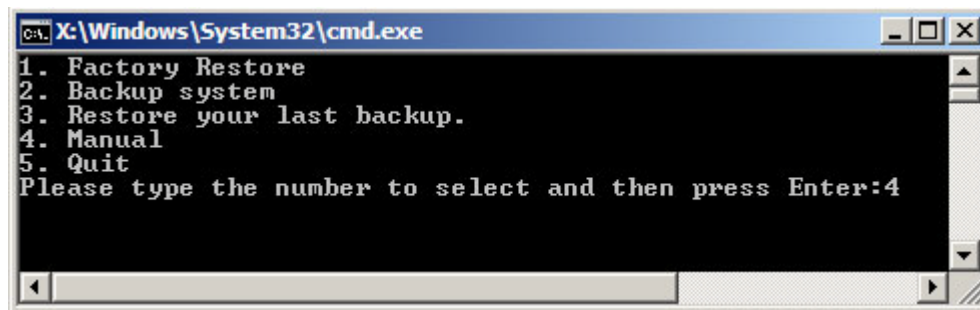

Figure B-11: Recovery Tool Menu

Step 3: The About Symantec Ghost window appears. Click **OK** button to continue.

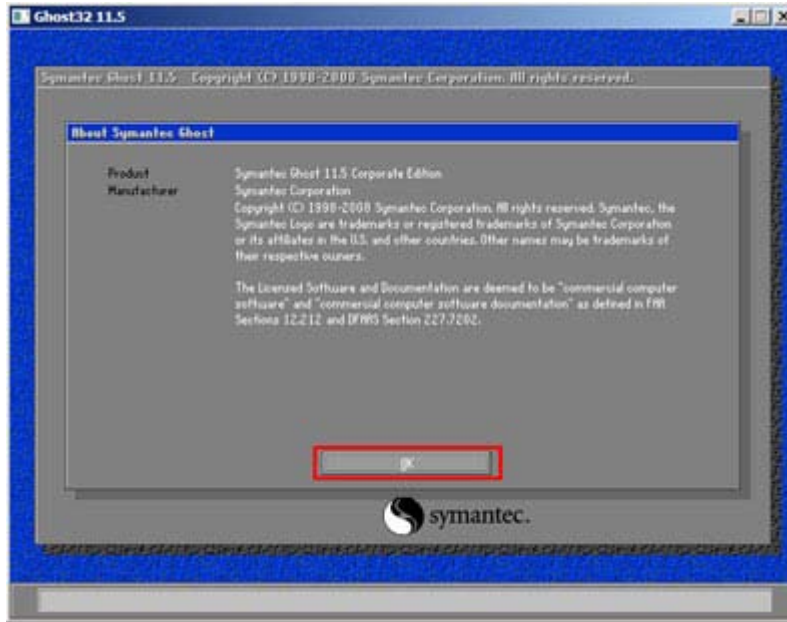

Figure B-12: About Symantec Ghost Window

Step 4: Use mouse to navigate to the option shown below (Figure B-13).

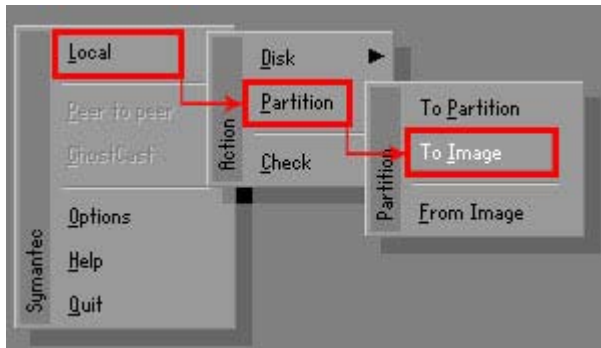

Figure B-13: Symantec Ghost Path

Step 5: Select the local source drive (Drive 1) as shown in Figure B-14. Then click OK.

HYPER-KBN

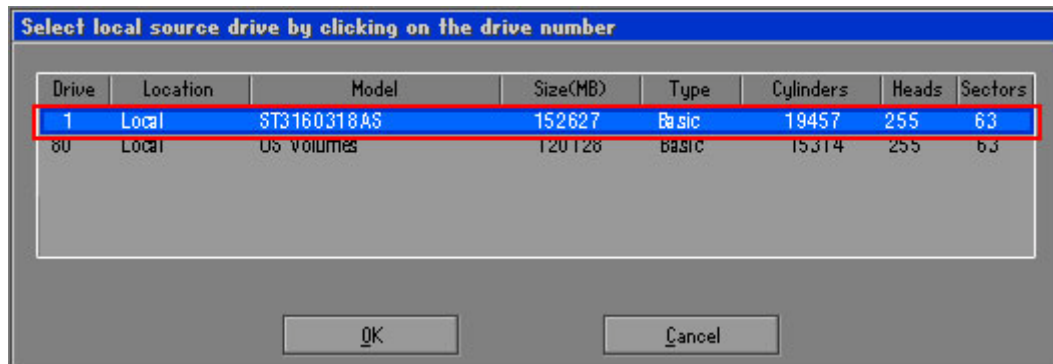

Figure B-14: Select a Local Source Drive

Step 6: Select a source partition (Part 1) from basic drive as shown in **Figure B-15**. Then click OK.

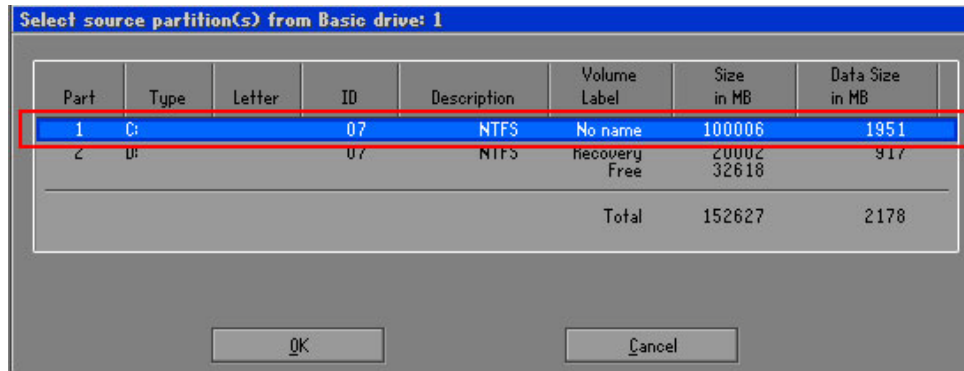

Figure B-15: Select a Source Partition from Basic Drive

Step 7: Select **1.2: [Recovery] NTFS drive** and enter a file name called **iei** (**Figure B-16**). Click **Save**. The factory default image will then be saved in the selected recovery drive and named **IEI.GHO**.



WARNING:

The file name of the factory default image must be **iei.GHO**.

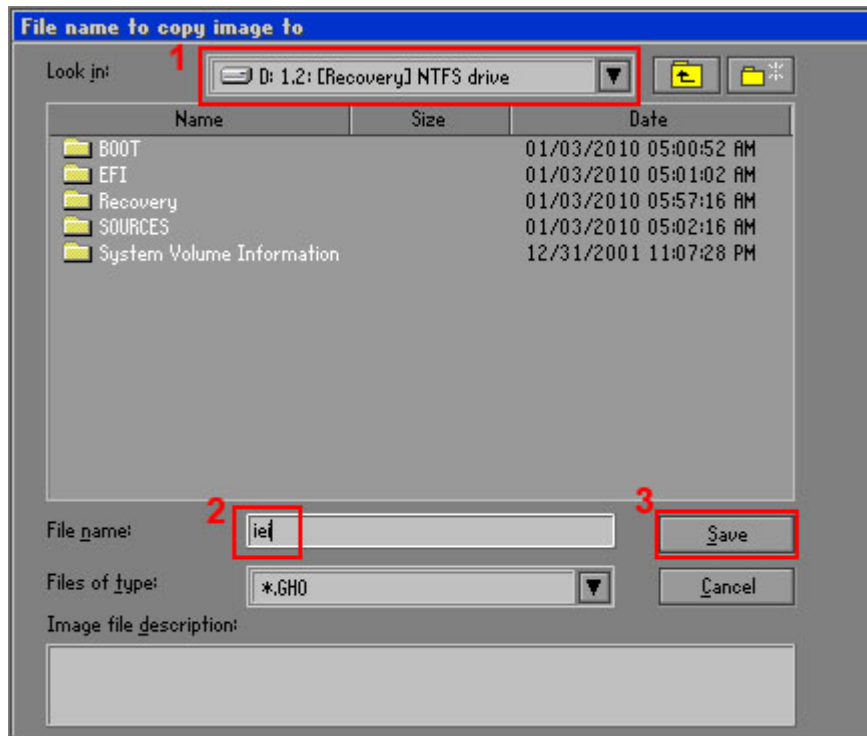

Figure B-16: File Name to Copy Image to

Step 8: When the Compress Image screen in **Figure B-17** prompts, click **High** to make the image file smaller.

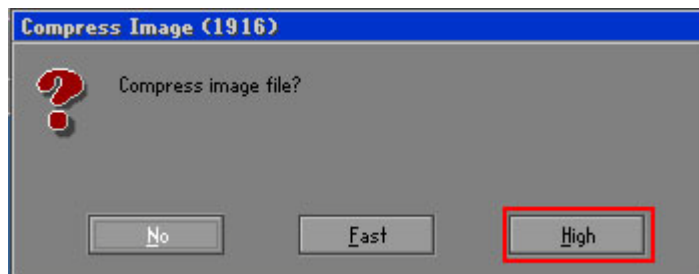

Figure B-17: Compress Image

HYPER-KBN

Step 9: The Proceed with partition image creation window appears, click **Yes** to continue.

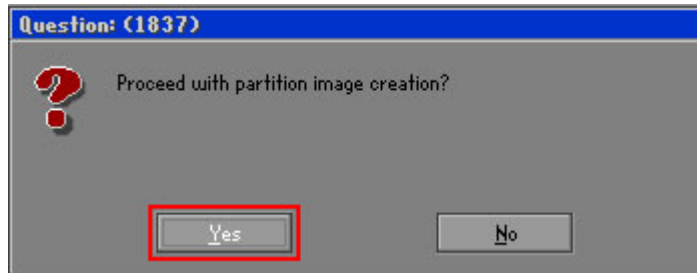

Figure B-18: Image Creation Confirmation

Step 10: The Symantec Ghost starts to create the factory default image (**Figure B-19**).

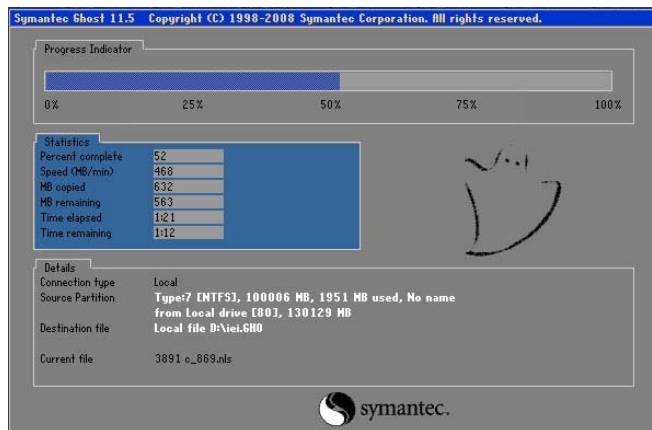

Figure B-19: Image Creation Complete

Step 11: When the image creation completes, a screen prompts as shown in **Figure B-20**.

Click **Continue** and close the Ghost window to exit the program.

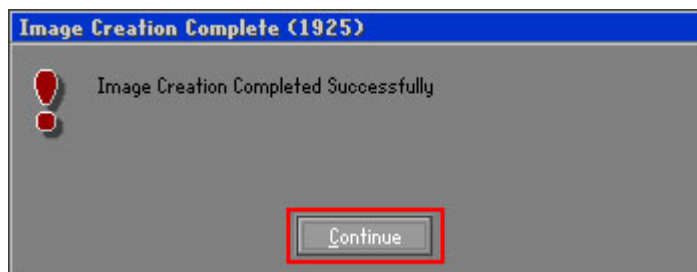
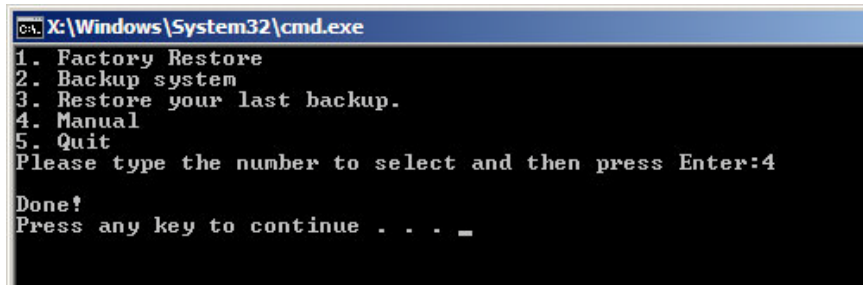

Figure B-20: Image Creation Complete

Step 12: The recovery tool main menu window is shown as below. Press any key to reboot the system.

A screenshot of a Windows command prompt window titled "C:\Windows\System32\cmd.exe". The window contains a menu with five numbered options: 1. Factory Restore, 2. Backup system, 3. Restore your last backup., 4. Manual, and 5. Quit. Below the menu, it says "Please type the number to select and then press Enter:4". At the bottom, it says "Done!" and "Press any key to continue . . . _".

```
C:\Windows\System32\cmd.exe
1. Factory Restore
2. Backup system
3. Restore your last backup.
4. Manual
5. Quit
Please type the number to select and then press Enter:4
Done!
Press any key to continue . . . _
```

Figure B-21: Press Any Key to Continue

B.3 Auto Recovery Setup Procedure

The auto recovery function allows a system to automatically restore from the factory default image after encountering a Blue Screen of Death (BSoD) or a hang for around 10 minutes. To use the auto recovery function, follow the steps described in the following sections.



CAUTION:

The setup procedure may include a step to create a factory default image. It is suggested to configure the system to a factory default environment before the configuration, including driver and application installations.

Step 1: Follow the steps described in **Section B.2.1 ~ Section B.2.3** to setup BIOS, create partitions and install operating system.

Step 2: Install the auto recovery utility into the system by double clicking the **Utility/AUTORECOVERY-SETUP.exe** in the One Key Recovery CD. This utility **MUST** be installed in the system, otherwise, the system will automatically restore from the factory default image every ten (10) minutes.

HYPER-KBN



Figure B-22: Auto Recovery Utility

Step 3: Reboot the system from the recovery CD. When prompted, press any key to boot from the recovery CD. It will take a while to launch the recovery tool. Please be patient!

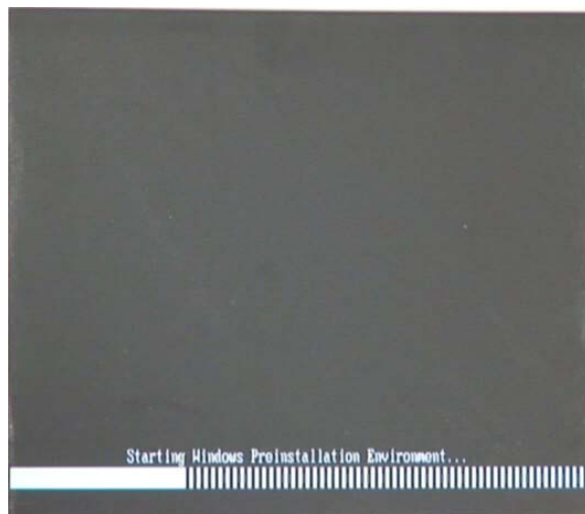

Figure B-23: Launching the Recovery Tool

Step 4: When the recovery tool setup menu appears, press <4> then <Enter>.

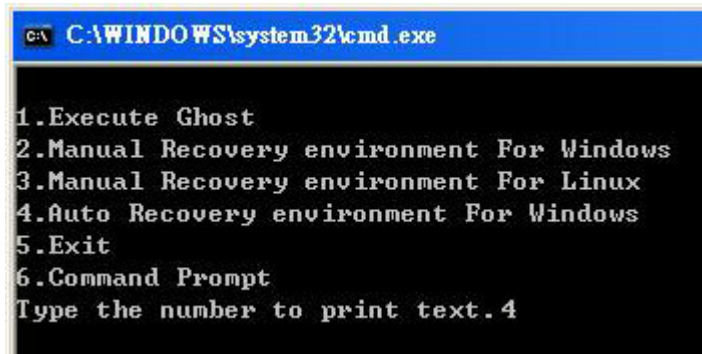

Figure B-24: Auto Recovery Environment for Windows

Step 5: The Symantec Ghost window appears and starts configuring the system to build an auto recovery partition. In this process the partition created for recovery files in **Section B.2.2** is hidden and the auto recovery tool is saved in this partition.

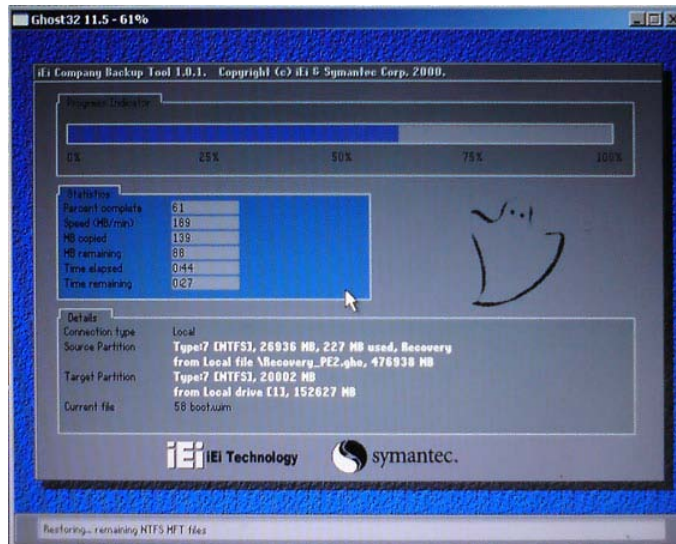

Figure B-25: Building the Auto Recovery Partition

Step 6: After completing the system configuration, the following message prompts to confirm whether to create a factory default image. Type **Y** to have the system create a factory default image automatically. Type **N** within 6 seconds to skip this process (The default option is YES). It is suggested to choose YES for this option.



Figure B-26: Factory Default Image Confirmation

HYPER-KBN

Step 7: The Symantec Ghost starts to create the factory default image (**Figure B-27**).

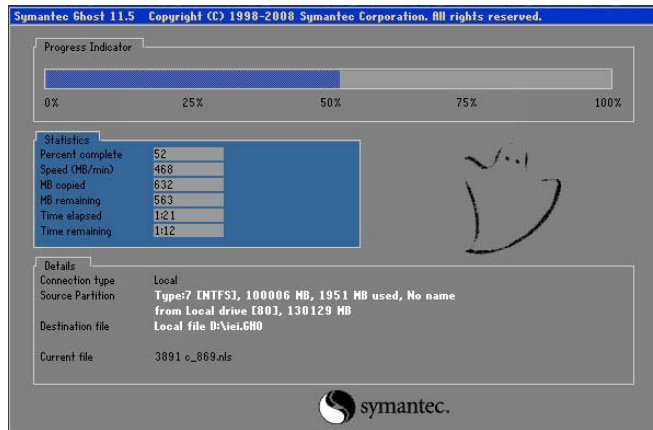

Figure B-27: Image Creation Complete

Step 8: After completing the system configuration, press any key in the following window to restart the system.

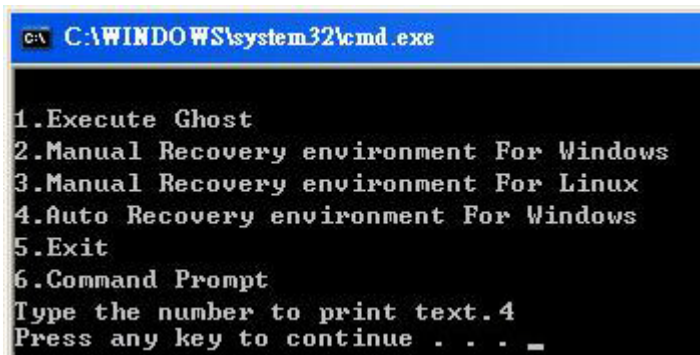

Figure B-28: Press any key to continue

Step 9: Eject the One Key Recovery CD and restart the system.

Step 10: Press the <DELETE> key as soon as the system is turned on to enter the BIOS.

Step 11: Enable the Auto Recovery Function option (**Advanced** → **iEi Feature** → **Auto Recovery Function**).

```

BIOS SETUP UTILITY
Main  Advanced  PCIPNP  Boot  Security  Chipset  Exit
-----
iEi Feature
-----
Auto Recovery Function      [Enabled]
  Recover from PXE          [Disabled]

                                  ←→  Select Screen
                                  ↑↓  Select Item
                                  Enter Go to SubScreen
                                  F1   General Help
                                  F10  Save and Exit
                                  ESC  Exit

v02.61 ©Copyright 1985-2006, American Megatrends, Inc.

```

BIOS Menu 20: IEI Feature

Step 12: Save changes and restart the system. If the system encounters a Blue Screen of Death (BSoD) or a hang for around 10 minutes, it will automatically restore from the factory default image.



CAUTION:

The auto recovery function can only apply on a Microsoft Windows system running the following OS versions:

- Windows XP
- Windows Vista
- Windows 7

B.4 Setup Procedure for Linux

The initial setup procedure for Linux system is mostly the same with the procedure for Microsoft Windows. Please follow the steps below to setup recovery tool for Linux OS.

Step 1: **Hardware and BIOS setup.** Refer to **Section B.2.1.**

HYPER-KBN

Step 2: Install Linux operating system. Make sure to install GRUB (v0.97 or earlier) MBR type and Ext3 partition type. Leave enough space on the hard drive to create the recover partition later.



NOTE:

If the Linux OS is not installed with GRUB (v0.97 or earlier) and Ext3, the Symantec Ghost may not function properly.

While installing Linux OS, please create two partitions:

- Partition 1: /
- Partition 2: **SWAP**



NOTE:

Please reserve enough space for partition 3 for saving recovery images.

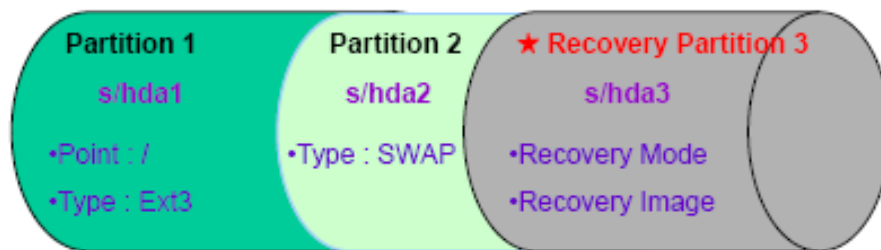

Figure B-29: Partitions for Linux

Step 3: Create a recovery partition. Insert the recovery CD into the optical disk drive. Follow **Step 1 ~ Step 3** described in **Section B.2.2**. Then type the following commands (marked in red) to create a partition for recovery images.

```
system32>diskpart
```

```
DISKPART>list vol
```

```
DISKPART>sel disk 0
```

```
DISKPART>create part pri size= ____
```

```
DISKPART>assign letter=N
```

```
DISKPART>exit
```

```
system32>format N: /fs:ntfs /q /v:Recovery /y
```

```
system32>exit
```

Step 4: Build the recovery partition. Press any key to boot from the recovery CD. It will take a while to launch the recovery tool. Please be patient. When the recovery tool setup menu appears, type <3> and press <Enter> (**Figure B-30**). The Symantec Ghost window appears and starts configuring the system to build a recovery partition. After completing the system configuration, press any key to reboot the system. Eject the recovery CD.

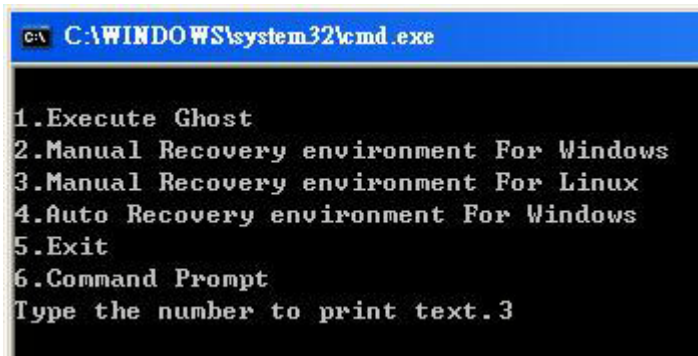
A screenshot of a Windows command prompt window. The title bar reads "C:\WINDOWS\system32\cmd.exe". The window content shows a menu with the following options:

```
1. Execute Ghost
2. Manual Recovery environment For Windows
3. Manual Recovery environment For Linux
4. Auto Recovery environment For Windows
5. Exit
6. Command Prompt
Type the number to print text.3
```

Figure B-30: Manual Recovery Environment for Linux

Step 5: Access the recovery tool main menu by modifying the “menu.lst”. To first access the recovery tool main menu, the menu.lst must be modified. In Linux, enter Administrator (root). When prompt appears, type:

```
cd /boot/grub
```

```
vi menu.lst
```

HYPER-KBN

```
Fedora release 9 (Sulphur)
Kernel 2.6.25-14.fc9.i686 on an i686 (tty2)

localhost login: root
Password:
[root@localhost ~]# cd /boot/grub/
[root@localhost grub]# vi menu.lst _
```

Figure B-31: Access menu.lst in Linux (Text Mode)

Step 6: Modify the menu.lst as shown below.

```
#boot=/dev/sda
default=0
timeout=10 ← Modify timeout=10
splashimage=(hd0,0)/grub/splash.xpm.gz
hiddenmenu
title Fedora (2.6.25-14.fc9.i686)
    root (hd0,0)
    kernel /vmlinuz-2.6.25-14.fc9.i686 ro root=UUID=10f1acda
    ac38b5c78910 rhgb quiet
    initrd /initrd-2.6.25-14.fc9.i686.img

title Recovery Partition
root (hd0,2)
makeactive ← Type command
chainloader +1
```

- Type command:
title Recovery Partition
root (hd0,2)
makeactive
chainloader +1

Step 7: The recovery tool menu appears. (Figure B-32)

```
1. Factory Restore
2. Backup system
3. Restore your last backup.
4. Manual
5. Quit
Please type the number to select and then press Enter:
```

Figure B-32: Recovery Tool Menu

Step 8: Create a factory default image. Follow Step 2 ~ Step 12 described in Section B.2.5 to create a factory default image.

B.5 Recovery Tool Functions

After completing the initial setup procedures as described above, users can access the recovery tool by pressing <F3> while booting up the system. However, if the setup procedure in Section B.3 has been completed and the auto recovery function is enabled, the system will automatically restore from the factory default image without pressing the F3 key. The recovery tool main menu is shown below.

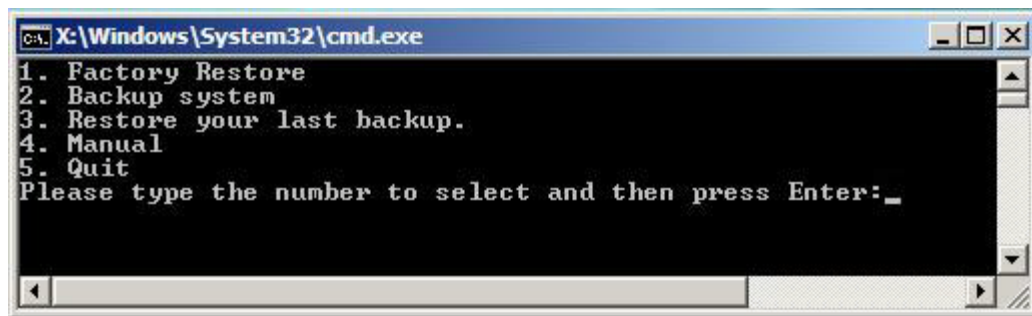

Figure B-33: Recovery Tool Main Menu

The recovery tool has several functions including:

1. **Factory Restore:** Restore the factory default image (iei.GHO) created in Section B.2.5.
2. **Backup system:** Create a system backup image (iei_user.GHO) which will be saved in the hidden partition.
3. **Restore your last backup:** Restore the last system backup image
4. **Manual:** Enter the Symantec Ghost window to configure manually.
5. **Quit:** Exit the recovery tool and restart the system.



WARNING:

Please do not turn off the system power during the process of system recovery or backup.

HYPER-KBN

**WARNING:**

All data in the system will be deleted during the system recovery. Please backup the system files before restoring the system (either Factory Restore or Restore Backup).

B.5.1 Factory Restore

To restore the factory default image, please follow the steps below.

Step 1: Type <1> and press <Enter> in the main menu.

Step 2: The Symantec Ghost window appears and starts to restore the factory default. A factory default image called **iei.GHO** is created in the hidden Recovery partition.

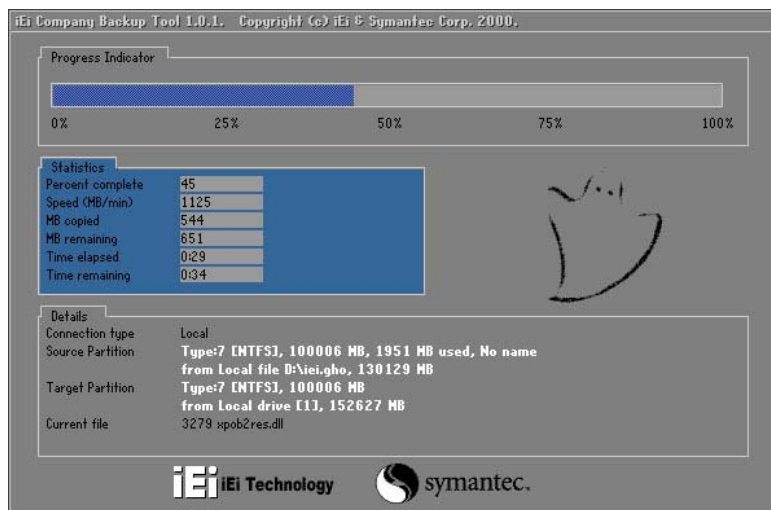

Figure B-34: Restore Factory Default

Step 3: The screen shown in **Figure B-35** appears when completed. Press any key to reboot the system.

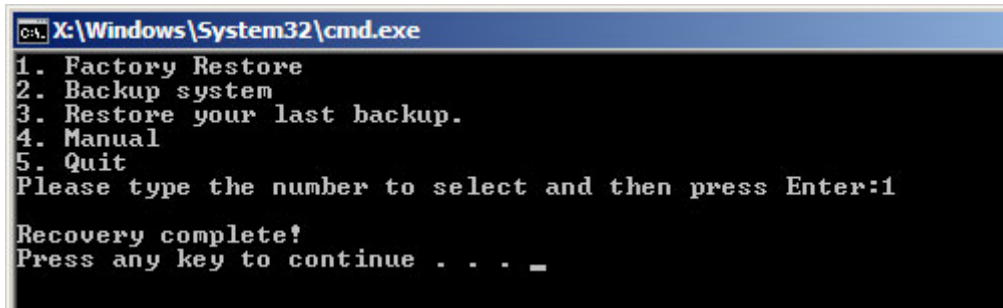

Figure B-35: Recovery Complete Window

B.5.2 Backup System

To backup the system, please follow the steps below.

Step 1: Type **<2>** and press **<Enter>** in the main menu.

Step 2: The Symantec Ghost window appears and starts to backup the system. A backup image called **iei_user.GHO** is created in the hidden Recovery partition.

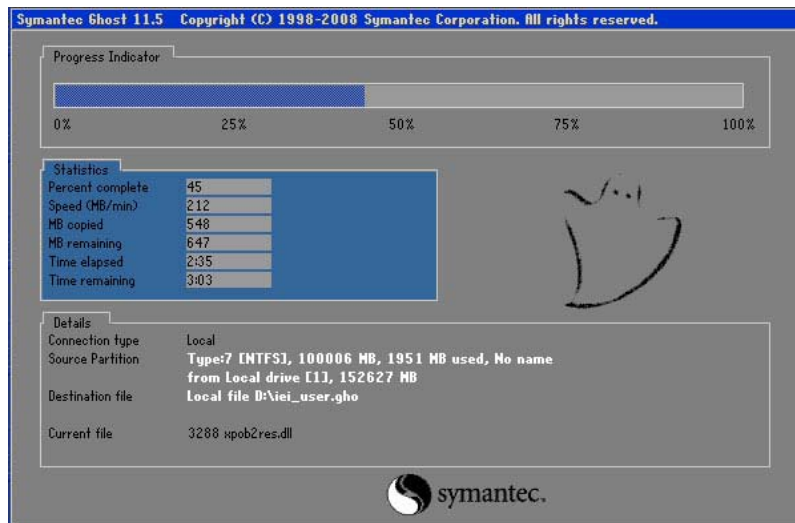

Figure B-36: Backup System

Step 3: The screen shown in **Figure B-37** appears when system backup is complete. Press any key to reboot the system.

HYPER-KBN

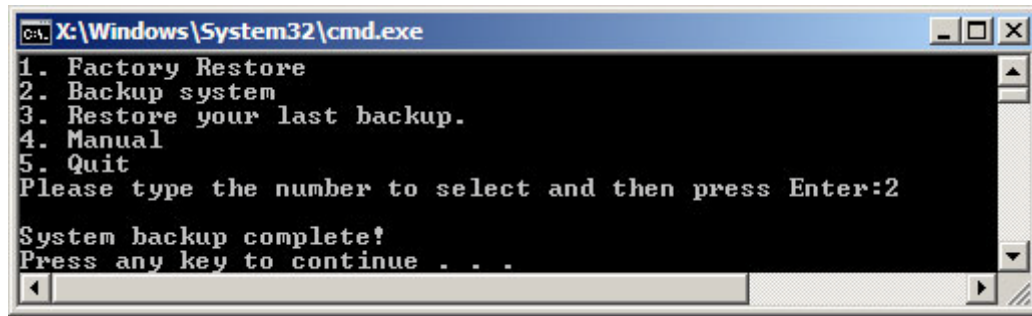

Figure B-37: System Backup Complete Window

B.5.3 Restore Your Last Backup

To restore the last system backup, please follow the steps below.

Step 1: Type <3> and press <Enter> in the main menu.

Step 2: The Symantec Ghost window appears and starts to restore the last backup image (iei_user.GHO).

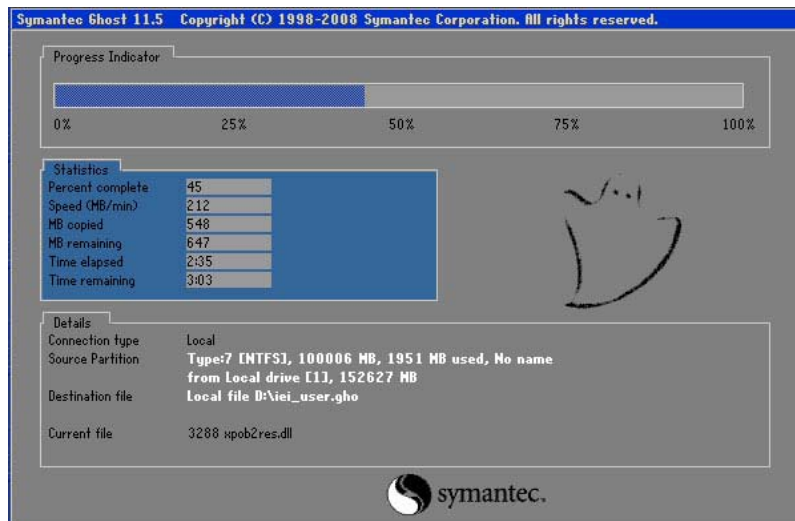
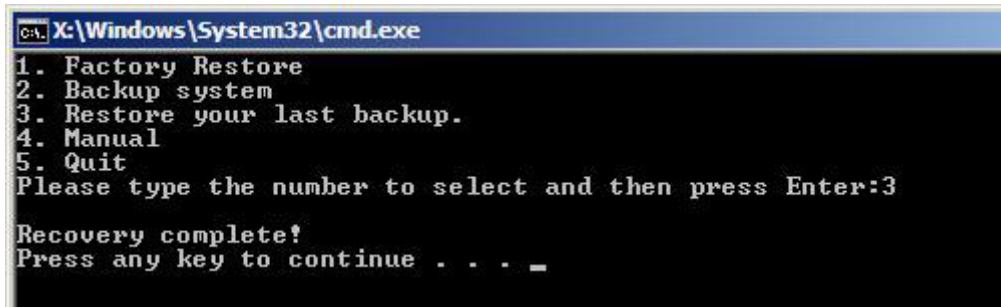

Figure B-38: Restore Backup

Step 3: The screen shown in **Figure B-39** appears when backup recovery is complete. Press any key to reboot the system.



```
C:\X:\Windows\System32\cmd.exe
1. Factory Restore
2. Backup system
3. Restore your last backup.
4. Manual
5. Quit
Please type the number to select and then press Enter:3
Recovery complete!
Press any key to continue . . . _
```

Figure B-39: Restore System Backup Complete Window

B.5.4 Manual

To restore the last system backup, please follow the steps below.

Step 4: Type <4> and press <Enter> in the main menu.

Step 5: The Symantec Ghost window appears. Use the Ghost program to backup or recover the system manually.

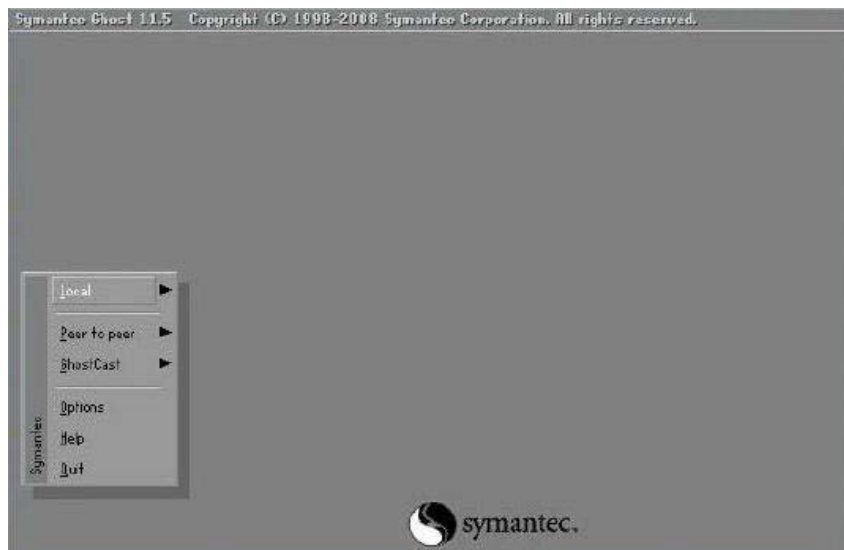

Figure B-40: Symantec Ghost Window

Step 6: When backup or recovery is completed, press any key to reboot the system.

HYPER-KBN

B.6 Restore Systems from a Linux Server through LAN

The One Key Recovery allows a client system to automatically restore to a factory default image saved in a Linux system (the server) through LAN connectivity after encountering a Blue Screen of Death (BSoD) or a hang for around 10 minutes. To be able to use this function, the client system and the Linux system MUST reside in the same domain.

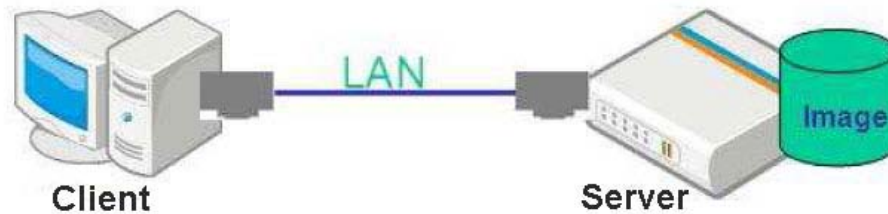

NOTE:

The supported client OS includes:

- Windows 2000
- Windows XP
- Windows Vista
- Windows 7
- Windows CE
- Windows XP Embedded

Prior to restoring client systems from a Linux server, a few setup procedures are required.

Step 1: Configure DHCP server settings

Step 2: Configure TFTP settings

Step 3: Configure One Key Recovery server settings

Step 4: Start DHCP, TFTP and HTTP

Step 5: Create a shared directory

Step 6: Setup a client system for auto recovery

The detailed descriptions are described in the following sections. In this document, two types of Linux OS are used as examples to explain the configuration process – CentOS 5.5 (Kernel 2.6.18) and Debian 5.0.7 (Kernel 2.6.26).

B.6.1 Configure DHCP Server Settings

Step 1: Install the DHCP

`#yum install dhcp` (CentOS, commands marked in red)

`#apt-get install dhcp3-server` (Debian, commands marked in blue)

Step 2: Confirm the operating system default settings: dhcpd.conf.

CentOS

Use the following command to show the DHCP server sample location:

`#vi /etc/dhcpd.conf`

The DHCP server sample location is shown as below:

```
# DHCP Server Configuration file.
# see /usr/share/doc/dhcp*/dhcpd.conf.sample
#
```

Use the following command to copy the DHCP server sample to etc/dhcpd.conf:

`#cp /usr/share/doc/dhcp-3.0.5/dhcpd.conf.sample /etc/dhcpd.conf`

`#vi /etc/dhcpd.conf`

```
ddns-update-style interim;
ignore client-updates;

subnet 192.168.0.0 netmask 255.255.255.0 {
# --- default gateway
    option routers                192.168.0.2;
    option subnet-mask            255.255.255.0;

    option nis-domain             "domain.org";
    option domain-name            "domain.org";
    option domain-name-servers    192.168.0.1;
    next-server 192.168.0.6;
    filename "pxelinux.0";
    option time-offset             -18000; # Eastern Standard Time
    option ntp-servers             192.168.1.1;
}
```

Debian

`#vi /etc/dhcpd.conf`

Edit “/etc/dhcpd.conf” for your environment. For example, add

`next-server PXE server IP address;`

HYPER-KBN

```
filename "pxelinux.0";
```

```
ddns-update-style interim;
ignore client-updates;

subnet 192.168.0.0 netmask 255.255.255.0 {
# --- default gateway
    option routers                192.168.0.2;
    option subnet-mask            255.255.255.0;

    option nis-domain              "domain.org";
    option domain-name            "domain.org";
    option domain-name-servers    192.168.0.1;
    next-server 192.168.0.6;
    filename "pxelinux.0";
    option time-offset            -18000; # Eastern Standard time
    option ntp-servers            192.168.1.1;
}
```

B.6.2 Configure TFTP Settings

Step 1: Install the tftp, httpd and syslinux.

```
#yum install tftp-server httpd syslinux (CentOS)
```

```
#apt-get install tftpd-hpa xinetd syslinux (Debian)
```

Step 2: Enable the TFTP server by editing the "/etc/xinetd.d/tftp" file and make it use the remap file. The "-vvv" is optional but it could definitely help on getting more information while running the remap file. For example:

CentOS

```
#vi /etc/xinetd.d/tftp
```

Modify:

```
disable = no
```

```
server_args = -s /tftpboot -m /tftpboot/tftpd.remap -vvv_
```

```
socket_type      = dgram
protocol         = udp
wait             = yes
user             = root
server           = /usr/sbin/in.tftpd
server_args      = -s /tftpboot -m /tftpboot/tftpd.remap -vvv
disable          = no
per_source       = 11
cps              = 100 2
flags            = IPv4
```

Debian

Replace the TFTP settings from “inetd” to “xinetd” and annotate the “inetd” by adding “#”.

`#vi /etc/inetd.conf`

Modify: `#tftp dgram udp wait root /usr/sbin.....` (as shown below)

```
#:BOOT: TFTP service is provided primarily for booting. Most sites
#      run this only on machines acting as "boot servers."
#tftp  dgram  udp   wait  root  /usr/sbin/in.tftpd /usr/sbin/in.tftpd -s
/var/lib/tftpboot
```

`#vi /etc/xinetd.d/tftp`

```
socket_type      = dgram
protocol         = udp
wait            = yes
user            = root
server          = /usr/sbin/in.tftpd
server_args     = -s /tftpboot -m /tftpboot/tftpd.remap -vvv
disable         = no
per_source      = 11
cps             = 100 2
flags           = IPv4
```

B.6.3 Configure One Key Recovery Server Settings

Step 1: Copy the **Utility/RECOVERYR10.TAR.BZ2** package from the One Key Recovery CD to the system (server side).



Step 2: Extract the recovery package to /.

```
#cp RecoveryR10.tar.bz2 /
#cd /
#tar -xvjf RecoveryR10.tar.bz2
```

Step 3: Copy “pxelinux.0” from “syslinux” and install to “tftpboot”.

```
#cp /usr/lib/syslinux/pxelinux.0 /tftpboot/
```

HYPER-KBN

B.6.4 Start the DHCP, TFTP and HTTP

Start the DHCP, TFTP and HTTP. For example:

CentOS

```
#service xinetd restart
```

```
#service httpd restart
```

```
#service dhcpd restart
```

Debian

```
#/etc/init.d/xinetd reload
```

```
#/etc/init.d/xinetd restart
```

```
#/etc/init.d/dhcp3-server restart
```

B.6.5 Create Shared Directory

Step 1: Install the samba.

```
#yum install samba
```

Step 2: Create a shared directory for the factory default image.

```
#mkdir /share
```

```
#cd /share
```

```
#mkdir /image
```

```
#cp iei.gho /image
```



WARNING:

The file name of the factory default image must be **iei.gho**.

Step 3: Confirm the operating system default settings: smb.conf.

```
#vi /etc/samba/smb.conf
```

Modify:

[image]

comment = One Key Recovery

path = /share/image

browseable = yes

writable = yes

public = yes

create mask = 0644

directory mask = 0755

Step 4: Edit "/etc/samba/smb.conf" for your environment. For example:

```
# "security = user" is always a good idea. This will require a Unix account
# in this server for every user accessing the server. See
# /usr/share/doc/samba-doc/htmldocs/Samba3-HOWTO/ServerType.html
# in the samba-doc package for details.
security = share
```

```
[image]
comment = One Key Recovery
path = /share/image
browseable = yes
writable = yes
public = yes
create mask = 0644
directory mask = 0755
```

Step 5: Modify the hostname

```
#vi /etc/hostname
```

Modify: RecoveryServer

```
RecoveryServer
```

B.6.6 Setup a Client System for Auto Recovery

Step 1: Configure the following BIOS options of the client system.

Advanced → iEi Feature → Auto Recovery Function → **Enabled**

Advanced → iEi Feature → Recover from PXE → **Enabled**

Boot → Launch PXE OpROM → **Enabled**

HYPER-KBN

Step 2: Continue to configure the **Boot Option Priorities** BIOS option of the client system:

Boot Option #1 → remain the default setting to boot from the original OS.

Boot Option #2 → select the boot from LAN option.

Step 3: Save changes and exit BIOS menu.

Exit → **Save Changes and Exit**

Step 4: Install the auto recovery utility into the system by double clicking the **Utility/AUTORECOVERY-SETUP.exe** in the One Key Recovery CD. This utility **MUST** be installed in the system, otherwise, the system will automatically restore from the factory default image every ten (10) minutes.



Step 5: Restart the client system from LAN. If the system encounters a Blue Screen of Death (BSoD) or a hang for around 10 minutes, it will automatically restore from the factory default image. The following screens will show when the system starts auto recovering.

```
Realtek PCIe GBE Family Controller Series v2.35 (06/14/10)
CLIENT MAC ADDR: 00 18 7D 13 E6 89  GUID: 00020003-0004-0005-0006-0007000000
DHCP . ./
```



```
My IP address seems to be C0A80009 192.168.0.9
ip=192.168.0.9:192.168.0.8:192.168.0.2:255.255.255.0
TFTP prefix:
Trying to load: pxelinux.cfg/00020003-0004-0005-0006-000700080009
Trying to load: pxelinux.cfg/01-00-18-7d-13-e6-89
Trying to load: pxelinux.cfg/C0A80009
Trying to load: pxelinux.cfg/C0A8000
Trying to load: pxelinux.cfg/C0A800
Trying to load: pxelinux.cfg/C0A80
Trying to load: pxelinux.cfg/C0A8
Trying to load: pxelinux.cfg/C0A
Trying to load: pxelinux.cfg/C0
Trying to load: pxelinux.cfg/C
Trying to load: pxelinux.cfg/default
boot:
```

```
Windows is loading files...
IP: 192.168.0.8, File: \Boot\WinPE.wim
```

Symantec Ghost 11.5 Copyright (C) 1998-2008 Symantec Corporation. All rights reserved.

Progress Indicator: 0% 25% 50% 75% 100%

Statistics	
Percent complete	52
Speed (MB/min)	468
MB copied	632
MB remaining	563
Time elapsed	1:21
Time remaining	1:12

Details:

Connection type	Local
Source Partition	Type:7 [NTFS], 100006 MB, 1951 MB used, No name from Local drive [80], 130129 MB
Destination file	Local file D:\iei.GHO
Current file	3891_e_869.nls

symantec.



NOTE:

A firewall or a SELinux is not in use in the whole setup process. If there is a firewall or a SELinux protecting the system, modify the configuration information to accommodate them.

HYPER-KBN

B.7 Other Information

B.7.1 Using AHCI Mode or ALi M5283 / VIA VT6421A Controller

When the system uses AHCI mode or some specific SATA controllers such as ALi M5283 or VIA VT6421A, the SATA RAID/AHCI driver must be installed before using one key recovery. Please follow the steps below to install the SATA RAID/AHCI driver.

Step 1: Copy the SATA RAID/AHCI driver to a floppy disk and insert the floppy disk into a USB floppy disk drive. The SATA RAID/AHCI driver must be especially designed for the on-board SATA controller.

Step 2: Connect the USB floppy disk drive to the system.

Step 3: Insert the One Key Recovery CD into the system and boot the system from the CD.

Step 4: When launching the recovery tool, press <F6>.

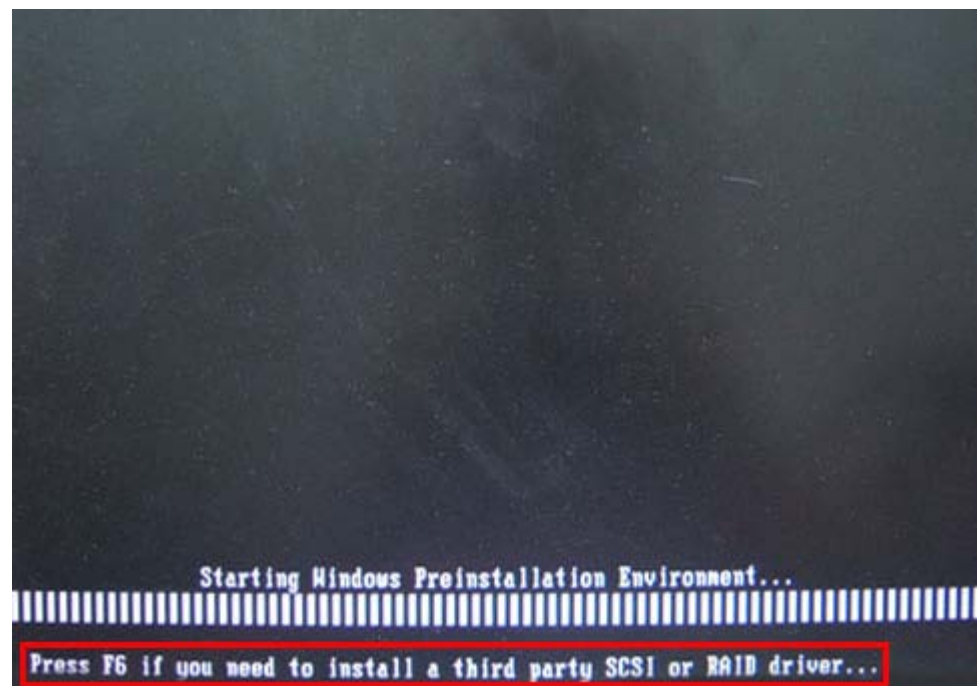

Step 5: When the following window appears, press <**S**> to select “Specify Additional Device”.

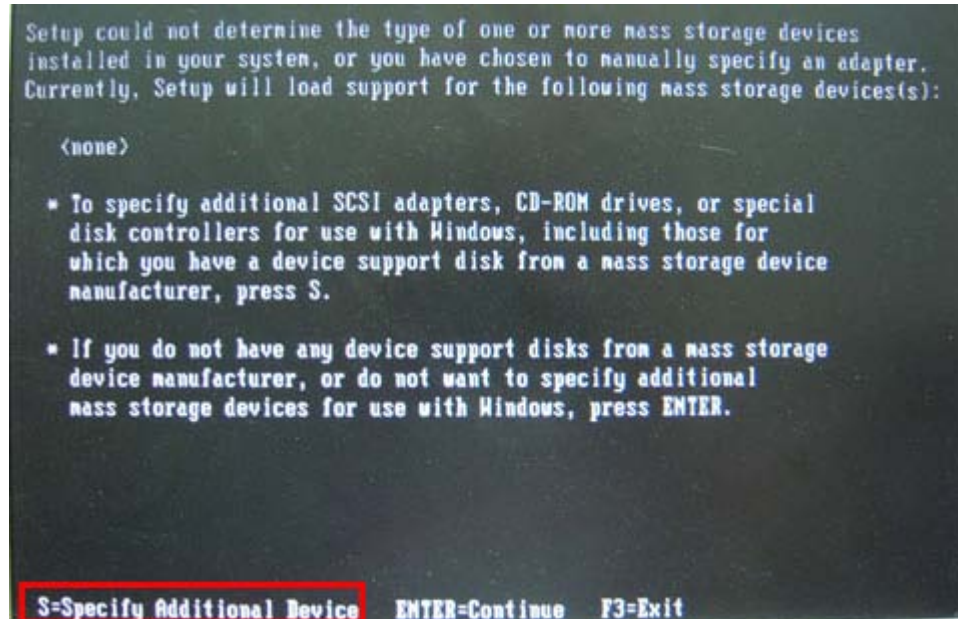

Step 6: In the following window, select a SATA controller mode used in the system. Then press <**Enter**>. The user can now start using the SATA HDD.

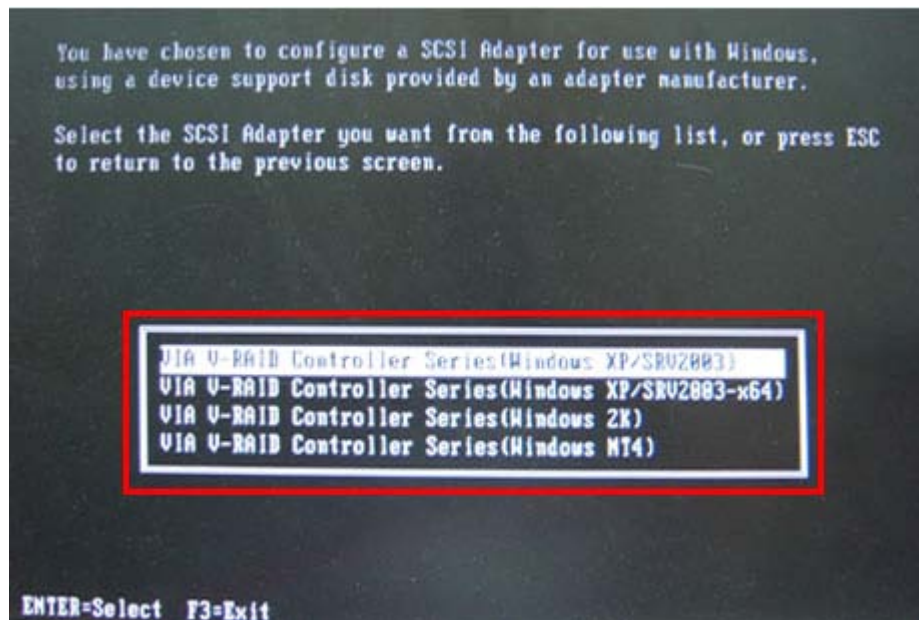

HYPER-KBN

Step 7: After pressing <Enter>, the system will get into the recovery tool setup menu.

Continue to follow the setup procedure from **Step 4** in **Section B.2.2 Create Partitions** to finish the whole setup process.

B.7.2 System Memory Requirement

To be able to access the recovery tool by pressing <F3> while booting up the system, please make sure to have enough system memory. The minimum memory requirement is listed below.

- **Using Award BIOS:** 128 MB system memory
- **Using AMI BIOS:** 512 MB system memory.

Appendix

C

Terminology

HYPER-KBN

AC '97	Audio Codec 97 (AC'97) refers to a codec standard developed by Intel® in 1997.
ACPI	Advanced Configuration and Power Interface (ACPI) is an OS-directed configuration, power management, and thermal management interface.
AHCI	Advanced Host Controller Interface (AHCI) is a SATA Host controller register-level interface.
ATA	The Advanced Technology Attachment (ATA) interface connects storage devices including hard disks and CD-ROM drives to a computer.
APM	The Advanced Power Management (APM) application program interface (API) enables the inclusion of power management in the BIOS.
ARMD	An ATAPI Removable Media Device (ARMD) is any ATAPI device that supports removable media, besides CD and DVD drives.
ASKIR	Amplitude Shift Keyed Infrared (ASKIR) is a form of modulation that represents a digital signal by varying the amplitude (“volume”) of the signal. A low amplitude signal represents a binary 0, while a high amplitude signal represents a binary 1.
BIOS	The Basic Input/Output System (BIOS) is firmware that is first run when the computer is turned on and can be configured by the end user
CODEC	The Compressor-Decompressor (CODEC) encodes and decodes digital audio data on the system.
CMOS	Complimentary metal-oxide-conductor is a type of integrated circuit used in chips like static RAM and microprocessors.
COM	COM is used to refer to serial ports. Serial ports offer serial communication to expansion devices. The serial port on a personal

	computer is usually a male DE-9 connector.
DAC	The Digital-to-Analog Converter (DAC) converts digital signals to analog signals.
DDR	Double Data Rate refers to a data bus transferring data on both the rising and falling edges of the clock signal.
DMA	Direct Memory Access (DMA) enables some peripheral devices to bypass the system processor and communicate directly with the system memory.
DIMM	Dual Inline Memory Modules are a type of RAM that offer a 64-bit data bus and have separate electrical contacts on each side of the module.
EHCI	The Enhanced Host Controller Interface (EHCI) specification is a register-level interface description for USB 2.0 Host Controllers.
GbE	Gigabit Ethernet (GbE) is an Ethernet version that transfers data at 1.0 Gbps and complies with the IEEE 802.3-2005 standard.
GPIO	General purpose input
IrDA	Infrared Data Association (IrDA) specify infrared data transmission protocols used to enable electronic devices to wirelessly communicate with each other.
L1 Cache	The Level 1 Cache (L1 Cache) is a small memory cache built into the system processor.
L2 Cache	The Level 2 Cache (L2 Cache) is an external processor memory cache.
LVDS	Low-voltage differential signaling (LVDS) is a dual-wire, high-speed differential electrical signaling system commonly used to connect LCD displays to a computer.
MAC	The Media Access Control (MAC) protocol enables several terminals or network nodes to communicate in a LAN, or other multipoint networks.

HYPER-KBN

PCIe	PCI Express (PCIe) is a communications bus that uses dual data lines for full-duplex (two-way) serial (point-to-point) communications between the SBC components and/or expansion cards and the SBC chipsets. Each line has a 2.5 Gbps data transmission rate and a 250 MBps sustained data transfer rate.
POST	The Power-on Self Test (POST) is the pre-boot actions the system performs when the system is turned-on.
QVGA	Quarter Video Graphics Array (QVGA) refers to a display with a resolution of 320 x 240 pixels.
RAM	Random Access Memory (RAM) is a form of storage used in computer. RAM is volatile memory, so it loses its data when power is lost. RAM has very fast data transfer rates compared to other storage like hard drives.
SATA	Serial ATA (SATA) is a serial communications bus designed for data transfers between storage devices and the computer chipsets. The SATA bus has transfer speeds up to 1.5 Gbps and the SATA 3Gb/s bus has data transfer speeds of up to 3.0 Gbps.
S.M.A.R.T	Self Monitoring Analysis and Reporting Technology (S.M.A.R.T) refers to automatic status checking technology implemented on hard disk drives.
UART	Universal Asynchronous Receiver-transmitter (UART) is responsible for asynchronous communications on the system and manages the system's serial communication (COM) ports.
UHCI	The Universal Host Controller Interface (UHCI) specification is a register-level interface description for USB 1.1 Host Controllers.
USB	The Universal Serial Bus (USB) is an external bus standard for interfacing devices. USB 1.1 supports 12Mbps data transfer rates, while

USB 2.0 supports 480Mbps data transfer rates.

VGA

The Video Graphics Array (VGA) is a graphics display system developed by IBM.

Appendix

D

Watchdog Timer

**NOTE:**

The following discussion applies to DOS environment. IEI support is contacted or the IEI website visited for specific drivers for more sophisticated operating systems, e.g., Windows and Linux.

The Watchdog Timer is provided to ensure that standalone systems can always recover from catastrophic conditions that cause the CPU to crash. This condition may have occurred by external EMI or a software bug. When the CPU stops working correctly, Watchdog Timer either performs a hardware reset (cold boot) or a Non-Maskable Interrupt (NMI) to bring the system back to a known state.

Call sub-function 2 to set the time-out period of Watchdog Timer first. If the time-out value is not zero, the Watchdog Timer starts counting down. While the timer value reaches zero, the system resets. To ensure that this reset condition does not occur, calling sub-function 2 must periodically refresh the Watchdog Timer. However, the Watchdog timer is disabled if the time-out value is set to zero.

A tolerance of at least 10% must be maintained to avoid unknown routines within the operating system (DOS), such as disk I/O that can be very time-consuming.

**NOTE:**

When exiting a program it is necessary to disable the Watchdog Timer, otherwise the system resets.

Example program:

```
//Enable WDT
mov edi,0xFED80B00h
mov ebx,0x81h
mov es:dword ptr [edi],ebx
```

HYPER-KBN

//Key Time

```
mov edi,0xFED80B04h
```

```
mov ebx,0x00h // 0x0000~0xFFFF
```

```
mov es:dword ptr [edi],ebx
```

//Start WDT

```
mov edi,0xFED80B00h
```

```
mov ebx,0x81h
```

```
mov es:dword ptr [edi],ebx
```

Appendix

E

Hazardous Materials Disclosure

HYPER-KBN

E.1 Hazardous Material Disclosure Table for IPB Products Certified as RoHS Compliant Under 2002/95/EC Without Mercury

The details provided in this appendix are to ensure that the product is compliant with the Peoples Republic of China (China) RoHS standards. The table below acknowledges the presences of small quantities of certain materials in the product, and is applicable to China RoHS only.

A label will be placed on each product to indicate the estimated “Environmentally Friendly Use Period” (EFUP). This is an estimate of the number of years that these substances would “not leak out or undergo abrupt change.” This product may contain replaceable sub-assemblies/components which have a shorter EFUP such as batteries and lamps. These components will be separately marked.

Please refer to the table on the next page.

Part Name	Toxic or Hazardous Substances and Elements					
	Lead (Pb)	Mercury (Hg)	Cadmium (Cd)	Hexavalent Chromium (CR(VI))	Polybrominated Biphenyls (PBB)	Polybrominated Diphenyl Ethers (PBDE)
Housing	X	O	O	O	O	X
Display	X	O	O	O	O	X
Printed Circuit Board	X	O	O	O	O	X
Metal Fasteners	X	O	O	O	O	O
Cable Assembly	X	O	O	O	O	X
Fan Assembly	X	O	O	O	O	X
Power Supply Assemblies	X	O	O	O	O	X
Battery	O	O	O	O	O	O

O: This toxic or hazardous substance is contained in all of the homogeneous materials for the part is below the limit requirement in SJ/T11363-2006

X: This toxic or hazardous substance is contained in at least one of the homogeneous materials for this part is above the limit requirement in SJ/T11363-2006

HYPER-KBN

此附件旨在确保本产品符合中国 RoHS 标准。以下表格标示此产品中某有毒物质的含量符合中国 RoHS 标准规定的限量要求。

本产品上会附有“环境友好使用期限”的标签，此期限是估算这些物质“不会有泄漏或突变”的年限。本产品可能包含有较短的环境友好使用期限的可替换元件，像是电池或灯管，这些元件将会单独标示出来。

部件名称	有毒有害物质或元素					
	铅 (Pb)	汞 (Hg)	镉 (Cd)	六价铬 (CR(VI))	多溴联苯 (PBB)	多溴二苯醚 (PBDE)
壳体	X	O	O	O	O	X
显示	X	O	O	O	O	X
印刷电路板	X	O	O	O	O	X
金属螺帽	X	O	O	O	O	O
电缆组装	X	O	O	O	O	X
风扇组装	X	O	O	O	O	X
电力供应组装	X	O	O	O	O	X
电池	O	O	O	O	O	O

O: 表示该有毒有害物质在该部件所有物质材料中的含量均在 SJ/T11363-2006 标准规定的限量要求以下。

X: 表示该有毒有害物质至少在该部件的某一均质材料中的含量超出 SJ/T11363-2006 标准规定的限量要求。