



NEXCOM International Co., Ltd.

## Industrial Computing Solutions

### Embedded Computing (3.5" CPU Board)

#### EBC 355

#### User Manual

# Contents

## Preface

Copyright .....	iv
Disclaimer .....	iv
Acknowledgements .....	iv
Regulatory Compliance Statements .....	iv
Declaration of Conformity .....	iv
RoHS Compliance .....	v
Warranty and RMA .....	vi
Safety Information .....	viii
Installation Recommendations .....	viii
Safety Precautions .....	ix
Technical Support and Assistance .....	x
Conventions Used in this Manual .....	x
Global Service Contact Information .....	xi
Package Contents .....	xiii
Ordering Information .....	xiv

## Chapter 1: Product Introduction

Overview .....	1
Key Features .....	1
Hardware Specifications .....	2
Knowing Your EBC 355 .....	4
Top View .....	4
Bottom View .....	5

## Chapter 2: Jumpers and Connectors

Before You Begin .....	6
Precautions .....	6
Jumper Settings .....	7
Locations of the Jumpers and Connectors .....	8
Top View .....	8
Bottom View .....	9
Jumpers .....	10
AT/ATX Power Type Select .....	10
LCD Power Select .....	10
PWM/CCFL Select .....	11
Connector Pin Definitions .....	12
External I/O Interfaces .....	12
VGA .....	12
HDMI .....	12
USB 3.0 Connector B .....	13
USB 3.0 Connector A .....	13
LAN1 Port .....	14
LAN2 Port .....	14
Internal Connectors .....	15
ATX Power Output Connector .....	15
Power Button (ATX) .....	15
RTC Clear Select .....	16
System Reset .....	16



SMBus .....	17
PS/2 Keyboard/Mouse Connector .....	17
System Fan Connector .....	18
GPIO Connector.....	18
COM Port 1 (RS232).....	19
COM Port 2 (RS232/RS422/RS485) .....	19
COM Port 3 (RS232).....	20
COM Port 4 (RS232).....	20
Mic-in Connector .....	21
Line-out Connector .....	21
Speaker-out Connector .....	22
LVDS Connector A .....	22
LVDS Connector B .....	23
LVDS Panel Inverter Connector .....	23
Mini-PCIe Slot (Wi-Fi) .....	24
Mini-PCIe Slot (3G).....	25
SIM Card Connector .....	26
SATA Connector A .....	26
SATA DOM Connector .....	27
SATA Power Connector .....	27
SATA DOM Power Connector.....	28
Power/HDD LED Connector.....	28
Block Diagram .....	29

### Chapter 3: BIOS Setup

About BIOS Setup .....	30
When to Configure the BIOS.....	30
Default Configuration .....	31
Entering Setup .....	31
Legends .....	31
BIOS Setup Utility.....	33

Main .....	33
Advanced .....	33
Chipset.....	41
Security .....	44
Boot.....	45
Save & Exit .....	46

### Appendix A: Watchdog Timer Setting.....47

### Appendix B: GPI/O Programming Guide.....48

# Preface

## Copyright

This publication, including all photographs, illustrations and software, is protected under international copyright laws, with all rights reserved. No part of this manual may be reproduced, copied, translated or transmitted in any form or by any means without the prior written consent from NEXCOM International Co., Ltd.

## Disclaimer

The information in this document is subject to change without prior notice and does not represent commitment from NEXCOM International Co., Ltd. However, users may update their knowledge of any product in use by constantly checking its manual posted on our website: <http://www.nexcom.com>. NEXCOM shall not be liable for direct, indirect, special, incidental, or consequential damages arising out of the use of any product, nor for any infringements upon the rights of third parties, which may result from such use. Any implied warranties of merchantability or fitness for any particular purpose is also disclaimed.

## Acknowledgements

EBC 355 is a trademark of NEXCOM International Co., Ltd. All other product names mentioned herein are registered trademarks of their respective owners.

## Regulatory Compliance Statements

This section provides the FCC compliance statement for Class B devices and describes how to keep the system CE compliant.

## Declaration of Conformity

### FCC

This equipment has been tested and verified to comply with the limits for a Class B digital device, pursuant to Part 15 of FCC Rules. These limits are designed to provide reasonable protection against harmful interference when the equipment is operated in a commercial environment. This equipment generates, uses, and can radiate radio frequency energy and, if not installed and used in accordance with the instructions, may cause harmful interference to radio communications. Operation of this equipment in a residential area (domestic environment) is likely to cause harmful interference, in which case the user will be required to correct the interference (take adequate measures) at their own expense.

### CE

The product(s) described in this manual complies with all applicable European Union (CE) directives if it has a CE marking. For computer systems to remain CE compliant, only CE-compliant parts may be used. Maintaining CE compliance also requires proper cable and cabling techniques.

## RoHS Compliance



### **NEXCOM RoHS Environmental Policy and Status Update**

NEXCOM is a global citizen for building the digital infrastructure. We are committed to providing green products and services, which are compliant with European Union RoHS (Restriction on Use of Hazardous Substance in Electronic Equipment) directive 2011/65/EU, to be your trusted green partner and to protect our environment.

RoHS restricts the use of Lead (Pb) < 0.1% or 1,000ppm, Mercury (Hg) < 0.1% or 1,000ppm, Cadmium (Cd) < 0.01% or 100ppm, Hexavalent Chromium (Cr6+) < 0.1% or 1,000ppm, Polybrominated biphenyls (PBB) < 0.1% or 1,000ppm, and Polybrominated diphenyl Ethers (PBDE) < 0.1% or 1,000ppm.

In order to meet the RoHS compliant directives, NEXCOM has established an engineering and manufacturing task force in to implement the introduction of green products. The task force will ensure that we follow the standard NEXCOM development procedure and that all the new RoHS components and new manufacturing processes maintain the highest industry quality levels for which NEXCOM are renowned.

The model selection criteria will be based on market demand. Vendors and suppliers will ensure that all designed components will be RoHS compliant.

### **How to recognize NEXCOM RoHS Products?**

For existing products where there are non-RoHS and RoHS versions, the suffix "(LF)" will be added to the compliant product name.

All new product models launched after January 2013 will be RoHS compliant. They will use the usual NEXCOM naming convention.

## Warranty and RMA

### NEXCOM Warranty Period

NEXCOM manufactures products that are new or equivalent to new in accordance with industry standard. NEXCOM warrants that products will be free from defect in material and workmanship for 2 years, beginning on the date of invoice by NEXCOM. HCP series products (Blade Server) which are manufactured by NEXCOM are covered by a three year warranty period.

### NEXCOM Return Merchandise Authorization (RMA)

- Customers shall enclose the “NEXCOM RMA Service Form” with the returned packages.
- Customers must collect all the information about the problems encountered and note anything abnormal or, print out any on-screen messages, and describe the problems on the “NEXCOM RMA Service Form” for the RMA number apply process.
- Customers can send back the faulty products with or without accessories (manuals, cable, etc.) and any components from the card, such as CPU and RAM. If the components were suspected as part of the problems, please note clearly which components are included. Otherwise, NEXCOM is not responsible for the devices/parts.
- Customers are responsible for the safe packaging of defective products, making sure it is durable enough to be resistant against further damage and deterioration during transportation. In case of damages occurred during transportation, the repair is treated as “Out of Warranty.”
- Any products returned by NEXCOM to other locations besides the customers’ site will bear an extra charge and will be billed to the customer.

### Repair Service Charges for Out-of-Warranty Products

NEXCOM will charge for out-of-warranty products in two categories, one is basic diagnostic fee and another is component (product) fee.

### Repair Service Charges for Out-of-Warranty Products

NEXCOM will charge for out-of-warranty products in two categories, one is basic diagnostic fee and another is component (product) fee.

### System Level

- Component fee: NEXCOM will only charge for main components such as SMD chip, BGA chip, etc. Passive components will be repaired for free, ex: resistor, capacitor.
- Items will be replaced with NEXCOM products if the original one cannot be repaired. Ex: motherboard, power supply, etc.
- Replace with 3rd party products if needed.
- If RMA goods can not be repaired, NEXCOM will return it to the customer without any charge.

### Board Level

- Component fee: NEXCOM will only charge for main components, such as SMD chip, BGA chip, etc. Passive components will be repaired for free, ex: resistors, capacitors.
- If RMA goods can not be repaired, NEXCOM will return it to the customer without any charge.

## Warnings

Read and adhere to all warnings, cautions, and notices in this guide and the documentation supplied with the chassis, power supply, and accessory modules. If the instructions for the chassis and power supply are inconsistent with these instructions or the instructions for accessory modules, contact the supplier to find out how you can ensure that your computer meets safety and regulatory requirements.

## Cautions

Electrostatic discharge (ESD) can damage system components. Do the described procedures only at an ESD workstation. If no such station is available, you can provide some ESD protection by wearing an antistatic wrist strap and attaching it to a metal part of the computer chassis.

## Safety Information

Before installing and using the device, note the following precautions:

- Read all instructions carefully.
- Do not place the unit on an unstable surface, cart, or stand.
- Follow all warnings and cautions in this manual.
- When replacing parts, ensure that your service technician uses parts specified by the manufacturer.
- Avoid using the system near water, in direct sunlight, or near a heating device.
- The load of the system unit does not solely rely for support from the rackmounts located on the sides. Firm support from the bottom is highly necessary in order to provide balance stability.
- The computer is provided with a battery-powered real-time clock circuit. There is a danger of explosion if battery is incorrectly replaced. Replace only with the same or equivalent type recommended by the manufacturer. Discard used batteries according to the manufacturer's instructions.

## Installation Recommendations

Ensure you have a stable, clean working environment. Dust and dirt can get into components and cause a malfunction. Use containers to keep small components separated.

Adequate lighting and proper tools can prevent you from accidentally damaging the internal components. Most of the procedures that follow require only a few simple tools, including the following:

- A Philips screwdriver
- A flat-tipped screwdriver
- A grounding strap
- An anti-static pad

Using your fingers can disconnect most of the connections. It is recommended that you do not use needle-nose pliers to disconnect connections as these can damage the soft metal or plastic parts of the connectors.



## Safety Precautions

1. Read these safety instructions carefully.
2. Keep this User Manual for later reference.
3. Disconnect the equipment from any AC outlet before cleaning or installing a component inside the chassis. Use a damp cloth. Do not use liquid or spray detergents for cleaning.
4. To prevent electrostatic build-up, leave the board in its anti-static bag until you are ready to install it.
5. For plug-in equipment, the power outlet socket must be located near the equipment and must be easily accessible.
6. Keep the board away from humidity.
7. Put the board on a stable surface. Dropping it or letting it fall may cause damage.
8. Wear anti-static wrist strap.
9. Do all preparation work on a static-free surface.
10. Make sure the voltage of the power source is correct before connecting the equipment to the power outlet.
11. Hold the board only by its edges. Be careful not to touch any of the components, contacts or connections.
12. All cautions and warnings on the board should be noted.
13. Use the correct mounting screws and do not over tighten the screws.
14. Keep the original packaging and the anti-static bag; in case the board has to be returned for repair or replacement.

## Technical Support and Assistance

1. For the most updated information of NEXCOM products, visit NEXCOM's website at [www.nexcom.com](http://www.nexcom.com).
2. For technical issues that require contacting our technical support team or sales representative, please have the following information ready before calling:
  - Product name and serial number
  - Detailed information of the peripheral devices
  - Detailed information of the installed software (operating system, version, application software, etc.)
  - A complete description of the problem
  - The exact wordings of the error messages

### Warning!

1. Handling the unit: carry the unit with both hands and handle it with care.
2. Maintenance: to keep the unit clean, use only approved cleaning products or clean with a dry cloth.
3. CompactFlash: Turn off the unit's power before inserting or removing a CompactFlash storage card.

## Conventions Used in this Manual



### Warning:

Information about certain situations, which if not observed, can cause personal injury. This will prevent injury to yourself when performing a task.



### Caution:

Information to avoid damaging components or losing data.



### Note:

Provides additional information to complete a task easily.

## Global Service Contact Information

### Headquarters

#### **NEXCOM International Co., Ltd.**

15F, No. 920, Chung-Cheng Rd.,  
ZhongHe District, New Taipei City, 23586,  
Taiwan, R.O.C.

Tel: +886-2-8226-7786

Fax: +886-2-8226-7782

[www.nexcom.com](http://www.nexcom.com)

### America

#### **USA**

#### **NEXCOM USA**

2883 Bayview Drive,  
Fremont CA 94538, USA

Tel: +1-510-656-2248

Fax: +1-510-656-2158

Email: [sales@nexcom.com](mailto:sales@nexcom.com)

[www.nexcom.com](http://www.nexcom.com)

### Asia

#### **Taiwan**

#### **Central Taiwan Office**

16F, No.250, Sec. 2, Chongde Rd.,  
Beitun Dist., Taichung City 406, R.O.C.

Tel: +886-4-2249-1179

Fax: +886-4-2249-1172

Email: [sales@nexcom.com.tw](mailto:sales@nexcom.com.tw)

[www.nexcom.com.tw](http://www.nexcom.com.tw)

### Japan

#### **NEXCOM Japan**

9F, Tamachi Hara Bldg., 4-11-5, Shiba Minato-ku,  
Tokyo, 108-0014, Japan

Tel: +81-3-5419-7830

Fax: +81-3-5419-7832

Email: [sales@nexcom-jp.com](mailto:sales@nexcom-jp.com)

[www.nexcom-jp.com](http://www.nexcom-jp.com)

### China

#### **NEXCOM China**

1F & 2F, Block A, No. 16 Yonyou Software Park,  
No. 68 Beiqing Road, Haidian District,

Beijing, 100094, China

Tel: +86-010-5704-2680

Fax: +86-010-5704-2681

Email: [sales@nexcom.cn](mailto:sales@nexcom.cn)

[www.nexcom.cn](http://www.nexcom.cn)

### Shanghai Office

Room 603/604, Huiyinmingzun Plaza Bldg., 1,  
No.609, Yunlin East Rd.,

Shanghai, 200062, China

Tel: +86-21-5278-5868

Fax: +86-21-3251-6358

Email: [sales@nexcom.cn](mailto:sales@nexcom.cn)

[www.nexcom.cn](http://www.nexcom.cn)

## Shenzhen Office

Room1707, North Block, Pines Bldg.,  
No.7 Tairan Rd., Futian Area,  
Shenzhen, 518040, China  
Tel: +86-755-8332-7203  
Fax: +86-755-8332-7213  
Email: sales@nexcom.cn  
www.nexcom.cn

## Wuhan Office

1-C1804/ 1805, Mingze Liwan,  
No. 519 South Luoshi Rd.,  
Hongshan District,  
Wuhan, 430070, China  
Tel: +86-27-8722-7400  
Fax: +86-27-8722-7400  
Email: sales@nexcom.cn  
www.nexcom.cn

## Chengdu Office

9F, Shuxiangxie, Xuefu Garden,  
No.12 Section 1, South Yihuan Rd.,  
Chengdu, 610061, China  
Tel: +86-28-8523-0186  
Fax: +86-28-8523-0186  
Email: sales@nexcom.cn  
www.nexcom.cn

## Europe

### Italy

#### NEXCOM ITALIA S.r.l

Via Gaudenzio Ferrari 29,  
21047 Saronno (VA), Italia  
Tel: +39 02 9628 0333  
Fax: +39 02 9286 9215  
Email: nexcomitalia@nexcom.eu  
www.nexcomitalia.it

### United Kingdom

#### NEXCOM EUROPE

10 Vincent Avenue,  
Crownhill Business Centre,  
Milton Keynes, Buckinghamshire MK8 0AB,  
United Kingdom  
Tel: +44-1908-267121  
Fax: +44-1908-262042  
Email: sales.uk@nexcom.eu  
www.nexcom.eu

## Package Contents

Before continuing, verify that the EBC 355 package that you received is complete. Your package should have all the items listed in the following table.

### EBC 355-E3845 (PN: 10E00035502X0) / EBC 355-E3826 (PN: 10E00035500X0)

Item	Part Number	Name	Description	Qty
1	20E00035502X0	ASSY EBC 355-E3845		1
2	60177A0359X00	(N)EBC 355 Quick Reference Guide VER:A SIZE:A4	KRAMER	1
3	602DCD0845X00	(N)EBC 355 CD DRIVER VER:1.0	JCL	1

### EBC 355 Cable Kit Optional (PN: 10E00035501X0)

Item	Part Number	Name	Description	Qty
1	60233ATA73X00	SATA Cable ACMELUX:19922413	Standard L:300mm	1
2	60233PS223X00	EBC563IO PS2 KB/MS Cable ACMELUX:19922439	PS2 to JST 8PIN 2.54mm L:200mm+-10mm	1
3	60233PW148X00	SATA Power Cable BEST:901-0405-300R	Housing 4P to Housing 5P L:300mm	1
4	60233SIO62X00	COM Port Cable CP:NEX-110819-01	UL2651#28x9C-DB9+TU1001-10 L:200mm	2

### EBC 355 Heatsink Kit Optional (PN: EBC 355 Heatsink Kit)

Item	Part Number	Name	Description	Qty
1	5044440079X00	Gasket for VIA CPU KGS:C-4505(20X20x1)+G4000	20x20x1.1mm	1
2	5044440090X00	(H)Thermal Pad APUS:3A2015001001500	15x10x1.5mm XR-PE	1
3	5050300683X00	(N)EBC 355 Heatsink VER:A THERMO TOUCH	74.3x98x21.4mm AL:6063	1

## Ordering Information

The following below provides ordering information for EBC 355.

### **EBC 355-E3826 (P/N: 10E00035500X0) RoHS Compliant**

Low power embedded board with Intel® Atom™ processor E3826 and based on Intel® integrated graphics engine w/ HDMI/24/48bit LVDS/4x USB3.0/4x COMs/2x Mini-PCIe/2x Gigabit LAN/2x SATA

### **EBC 355-E3845 (P/N: 10E000355001X0) RoHS Compliant**

Low power embedded board with Intel® Atom™ processor E3845 and based on Intel® integrated graphics engine w/ HDMI/24/48bit LVDS/4x USB3.0/4x COMs/2x Mini-PCIe/2x Gigabit LAN/2x SATA

# Chapter 1: Product Introduction

## Overview

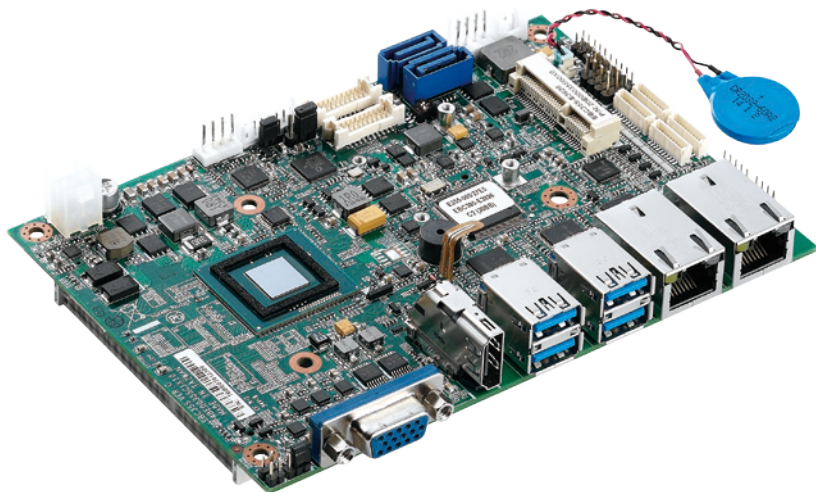

## Key Features

- On-board Intel® Atom™ Processor E3800 Product Family
- One 204-pin SO-DIMM socket supports up to 8GB DDR3L 1066/1333 MHz SDRAM
- Display: HDMI/VGA/1x LVDS (2x DF13 20-pin 24/48-bit Single channel)
- 2x Mini-PCIe
- 2x Intel® i210 PCI Express Gigabit Ethernet
- 2x SATA2.0
- 4x USB3.0, 4-in/4-out GPIO, Mic-in , Speak out
- Serial port: 3x RS232, 1x RS232/422/485 port
- Support AT/ATX mode and single +12VDC input

## Hardware Specifications

### CPU Support

- Support Intel® Atom™ processor E3800 product family

### Main Memory

- Single 204-pin SO-DIMM socket supports up to 8 GB DDR3L 1066/1333 MHz SDRAM

### Platform Control Hub

- Atom™ processor E3800 product family (formerly codenamed “Bay Trail-I”)

### BIOS

- AMI System BIOS
- Plug and play support
- Advanced Power Management and Advanced Configuration & Power Interface support

### On-board LAN

- 2x Intel® PCI Express Gigabit Ethernet
- Support Boot From LAN (PXE)
- 2x RJ45 with LED

### Display

- Integrated Intel® Gen.7 Graphics Engine
- Analog VGA interface
- Analog VGA interface: 1x DB-15 connector, resolution up to 1920 x 1200 @75Hz
- HDMI interface: 1x HDMI connector, resolution up to 1920 x 1200

- LVDS interface: 1x dual (24/48-bit) LVDS panel, resolution up to 1920 x 1200 DF13 20-pin LVDS connector for internal connection

### Audio

- Realtek ALC886 CODEC for High Definition:
  - 1x 4 2.0 pitch pin-header for Mic-in
  - 1x 4 2.0 pitch pin-header for Line-out
  - 1x 5 2.0 pitch pin-header for speaker out

### On-board LAN

- 2x Intel® i210 Gigabit Ethernet
- Support PXE boot from LAN, wake on LAN function

### Expansion

- 2x Mini-PCIe

### I/O Interface

- Serial port: 4 ports
  - COM1, 3, 4 support RS232 with 10-pin box header
  - COM2 support RS232/422/485 with 10-pin box header
- USB 3.0: 4 ports
  - 4x ports edge connector
- 8 GPIO lines via header (GPI 0~3 and GPO0~3) TTL level (0/5V)
- On-board power LED and HDD active LED pin header
- 1x 4-pin fan connector (for CPU)
- 1x keyboard/mouse pin header
- Onboard buzzer/SMBus2.0/reset SW/on & off switch button



### Edge I/O Interface

- 1x VGA connector
- 1x HDMI connector
- 2x dual stack USB 3.0 connector
- 2x RJ45 with LED connector

### Watchdog Timer

- Watchdog time-out can be programmed by software from 1 second to 255 seconds, and from 1 minute to 255 minutes (tolerance 15% under room temperature 25°C)

### Storage

- 2x SATA2.0 ports

### System Monitor

- Monitoring of 4 voltages and 2 temperatures
- 4 voltage (Vcore, +12V, +3.3V, 5V)
- 2 temperatures (CPU, system)
- 1 fan speed detection

### On-board RTC

- On-chip RTC with battery backup
- 1x external Li-ion battery

### Power Requirements

- Power requirement: +12V DC Input
- One 4-pin power connector

### Dimensions

- 146mm (L) x 102mm (W) 5.7" x 4.0"

### Environment

- Board level operating temperatures: -20°C to 60°C
- Storage temperatures: -25°C to 85°C
- Relative humidity:
  - 10% to 90% (operating, non-condensing)
  - 5% to 95% (non-operating, non-condensing)

### Certifications

- Meet CE
- FCC Class A

# Knowing Your EBC 355

## Top View

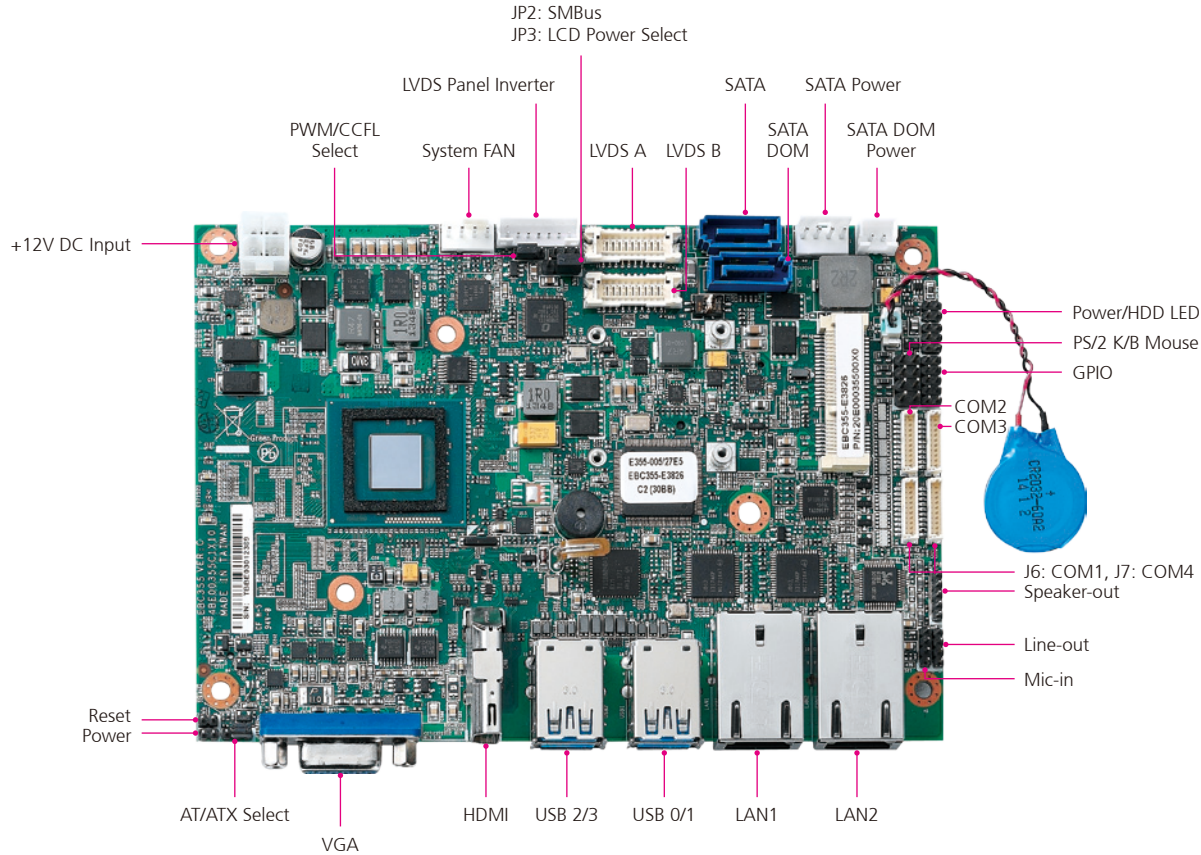

## Bottom View

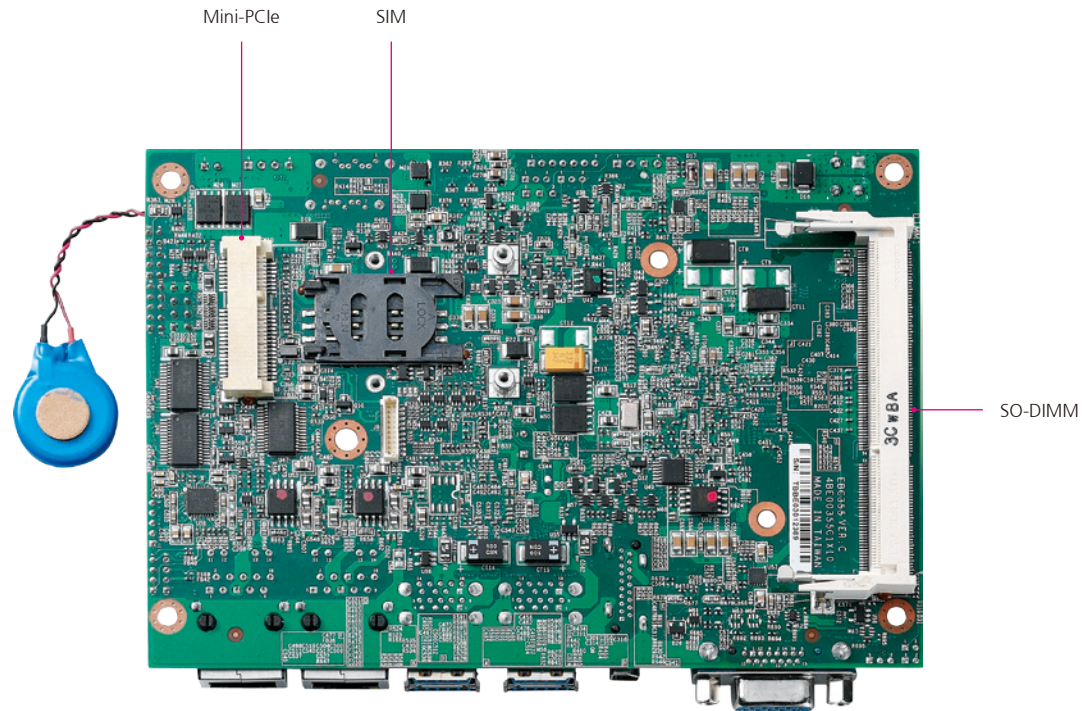

# Chapter 2: Jumpers and Connectors

This chapter describes how to set the jumpers and connectors on the EBC 355 motherboard.

## Before You Begin

- Ensure you have a stable, clean working environment. Dust and dirt can get into components and cause a malfunction. Use containers to keep small components separated.
- Adequate lighting and proper tools can prevent you from accidentally damaging the internal components. Most of the procedures that follow require only a few simple tools, including the following:
  - A Philips screwdriver
  - A flat-tipped screwdriver
  - A set of jewelers screwdrivers
  - A grounding strap
  - An anti-static pad
- Using your fingers can disconnect most of the connections. It is recommended that you do not use needle-nosed pliers to disconnect connections as these can damage the soft metal or plastic parts of the connectors.
- Before working on internal components, make sure that the power is off. Ground yourself before touching any internal components, by touching a metal object. Static electricity can damage many of the electronic components. Humid environments tend to have less static electricity than

dry environments. A grounding strap is warranted whenever danger of static electricity exists.

## Precautions

Computer components and electronic circuit boards can be damaged by discharges of static electricity. Working on computers that are still connected to a power supply can be extremely dangerous.

Follow the guidelines below to avoid damage to your computer or yourself:

- Always disconnect the unit from the power outlet whenever you are working inside the case.
- If possible, wear a grounded wrist strap when you are working inside the computer case. Alternatively, discharge any static electricity by touching the bare metal chassis of the unit case, or the bare metal body of any other grounded appliance.
- Hold electronic circuit boards by the edges only. Do not touch the components on the board unless it is necessary to do so. Don't flex or stress the circuit board.
- Leave all components inside the static-proof packaging that they shipped with until they are ready for installation.
- Use correct screws and do not over tighten screws.

## Jumper Settings

A jumper is the simplest kind of electric switch. It consists of two metal pins and a cap. When setting the jumpers, ensure that the jumper caps are placed on the correct pins. When the jumper cap is placed on both pins, the jumper is short. If you remove the jumper cap, or place the jumper cap on just one pin, the jumper is open.

Refer to the illustrations below for examples of what the 2-pin and 3-pin jumpers look like when they are short (on) and open (off).

Two-Pin Jumpers: Open (Left) and Short (Right)

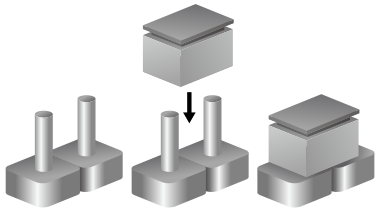

Three-Pin Jumpers: Pins 1 and 2 are Short

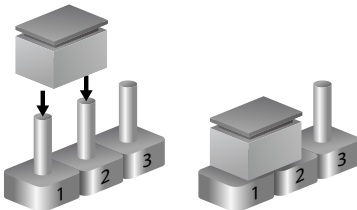

# Locations of the Jumpers and Connectors

The figure below shows the location of the jumpers and connectors.

## Top View

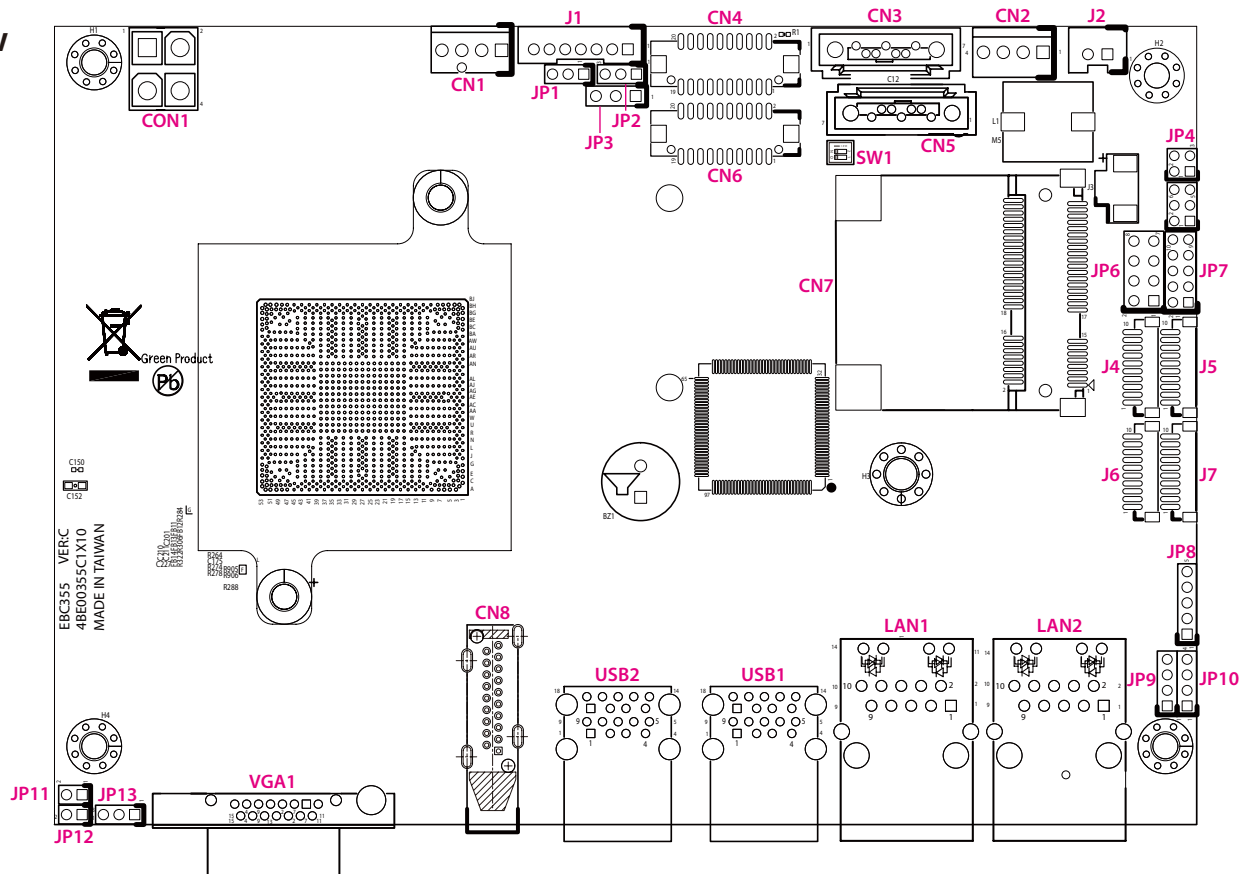

### Bottom View

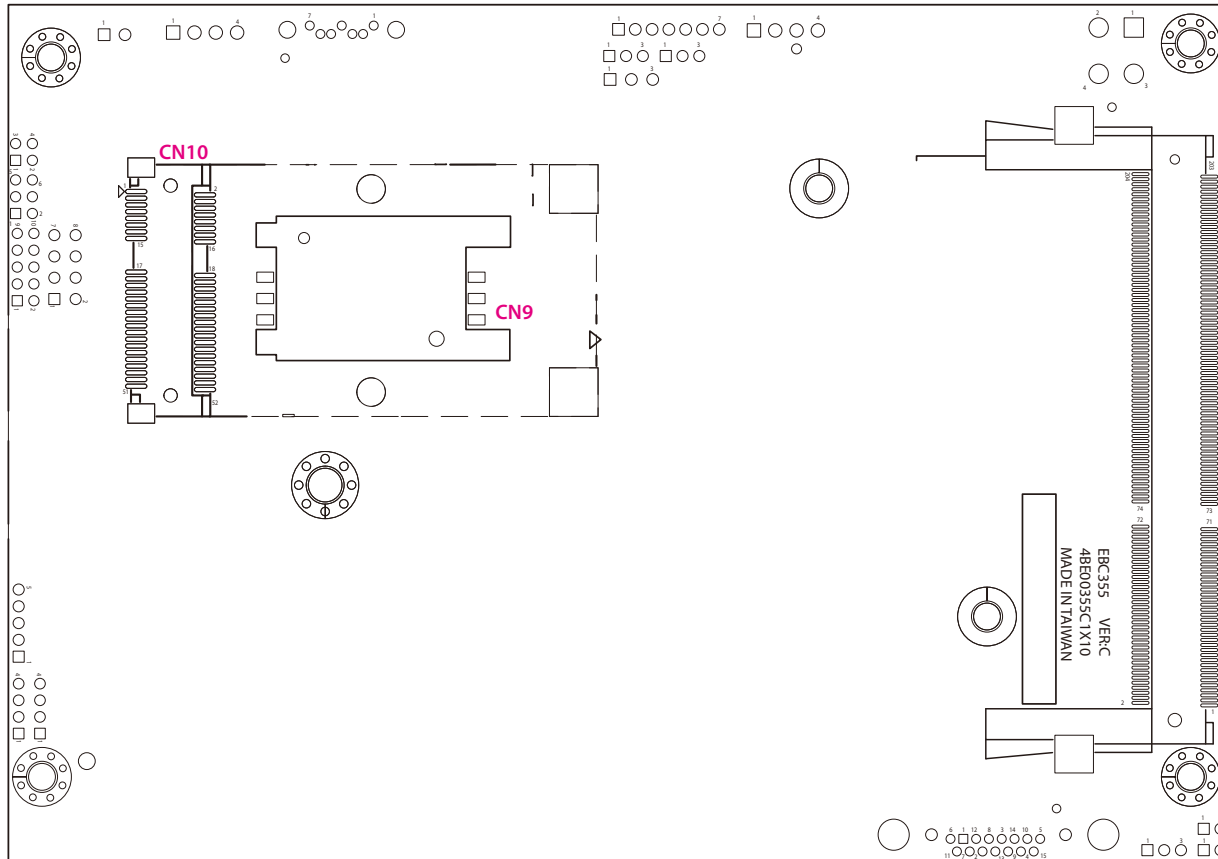

## Jumpers

### AT/ATX Power Type Select

Connector type: 1x3 3-pin header, 2.0mm pitch  
Connector location: JP13



Pin	Settings
1-2 On	AT Mode
2-3 On	ATX Mode

### LCD Power Select

Connector type: 1x3 3-pin header, 2.54mm  
Connector location: JP3



Pin	Settings
1-2 On	VCC3
2-3 On	VCC5



## PWM/CCFL Select

Connector type: 1x3 3-pin header, 2.0mm pitch  
Connector location: JP1



Pin	Definition
1-2	CCFL
2-3	PWM

## Connector Pin Definitions

### External I/O Interfaces

#### VGA

Connector type: DB-15 port, 15-pin D-Sub

Connector location: VGA1

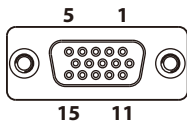

Pin	Definition	Pin	Definition
1	RED_VGA	2	GREEN_VGA
3	BLUE_VGA	4	NC
5	GND	6	VGADET
7	GND	8	GND
9	VCC5	10	GND
11	NC	12	DATA_VGA
13	HSYNC_VGA	14	VSYNC_VGA
15	DDCCLK_VGA		

#### HDMI

Connector type: HDMI port

Connector location: CN8

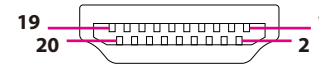

Pin	Definition	Pin	Definition
1	DATA2P	2	GND
3	DATA2N	4	DATA1P
5	GND	6	DATA1N
7	DATA0P	8	GND
9	DATA0N	10	CLKP
11	GND	12	CLKN
13	NC	14	NC
15	SCL CLK	16	SCL Data
17	GND	18	VCC5
19	HPD	MH1	GND
MH2	GND	MH3	GND
MH4	GND		

## USB 3.0 Connector B

Connector type: Dual USB port, Type A

Connector location: USB2

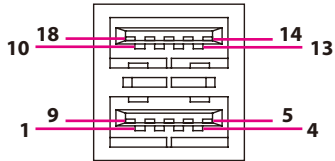

Pin	Definition	Pin	Definition
1	VCC5	2	DATA0-
3	DATA0+	4	GND
5	USB_RX2-	6	USB_RX2+
7	GND	8	USB_TX2-
9	USB_TX2+	10	VCC5
11	DATA1-	12	DATA1+
13	GND	14	USB_RX3-
15	USB_RX3+	16	GND
17	USB_TX3-	18	USB_TX3+

## USB 3.0 Connector A

Connector type: Dual USB port, Type A

Connector location: USB1

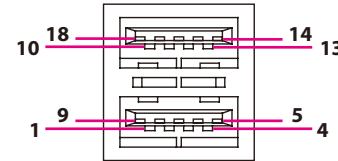

Pin	Definition	Pin	Definition
1	VCC5	2	DATA0-
3	DATA0+	4	GND
5	USB_RX0-	6	USB_RX0+
7	GND	8	USB_TX0-
9	USB_TX0+	10	VCC5
11	DATA1-	12	DATA1+
13	GND	14	USB_RX1-
15	USB_RX1+	16	GND
17	USB_TX1-	18	USB_TX1+

## LAN1 Port

Connector type: RJ45 port with LEDs

Connector location: LAN1

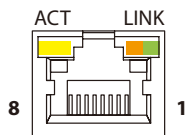

Act	Status
Flashing Yellow	Data activity
Off	No activity

Link	Status
Steady Green	1G network link
Steady Orange	100Mbps network link
Off	No link

Pin	Definition	Pin	Definition
1	LAN1_MDI0P	2	LAN1_MDI0N
3	LAN1_MDI1P	4	LAN1_MDI1N
5	1.5V	6	GND
7	LAN1_MDI2P	8	LAN1_MDI2N
9	LAN1_MDI3P	10	LAN1_MDI3N
11	LAN1_LED_LINK#	12	LAN1_LED_LINK1G#
13	LAN1_LED_ACT#	14	3VSB

## LAN2 Port

Connector type: RJ45 port with LEDs

Connector location: LAN2

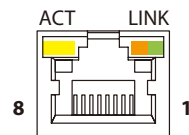

Act	Status
Flashing Yellow	Data activity
Off	No activity

Link	Status
Steady Green	1G network link
Steady Orange	100Mbps network link
Off	No link

Pin	Definition	Pin	Definition
1	LAN2_MDI0P	2	LAN2_MDI0N
3	LAN2_MDI1P	4	LAN2_MDI1N
5	1.5V	6	GND
7	LAN2_MDI2P	8	LAN2_MDI2N
9	LAN2_MDI3P	10	LAN2_MDI3N
11	LAN2_LED_LINK#	12	LAN2_LED_LINK1G#
13	LAN2_LED_ACT#	14	3VSB

## Internal Connectors

### ATX Power Output Connector

Connector type: 2x2 Aux power connector

Connector location: CON1

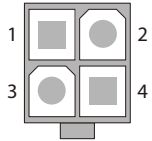

Pin	Definition
1	GND
2	GND
3	12V
4	12V

### Power Button (ATX)

Connector type: 1x2 2-pin header, 2.0mm pitch

Connector location: JP12



Pin	Definition
1	ATXBT
2	GND

## RTC Clear Select

Connector type: 2x2 4-pin DIP switch  
Connector location: SW1

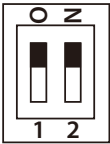

Pin	Definition
1 ON	Clear CMOS
2 ON	Clear ME

## System Reset

Connector type: 1x2 2-pin header, 2.0mm pitch  
Connector location: JP11



Pin	Definition
1	Reset
2	GND

## SMBus

Connector type: 1x3 3-pin header, 2.0mm pitch

Connector location: JP2



Pin	Definition
1	SMB_CLK
2	SMB_DATA
3	GND

## PS/2 Keyboard/Mouse Connector

Connector type: 2x4 8-pin header, 2.54mm pitch

Connector location: JP6

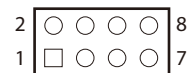

Pin	Definition	Pin	Definition
1	VCC5	2	VCC5
3	KDAT_R	4	MDAT_R
5	KCLK_R	6	MCLK_R
7	GND	8	GND

## System Fan Connector

Connector type: 1x4 4-pin Wafer, 2.54mm pitch

Connector location: CN1

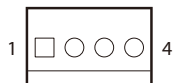

Pin	Definition
1	GND
2	12V
3	FANIN
4	FANOUT

## GPIO Connector

Connector type: 2x5 10-pin header, 2.0mm pitch

Connector location: JP7

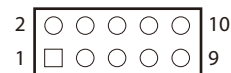

Pin	Definition	Pin	Definition
1	VCC5	2	GND
3	GPO0	4	GPIO
5	GPO1	6	GPI1
7	GPO2	8	GPI2
9	GPO3	10	GPI3



### COM Port 1 (RS232)

Connector type: 1x10 10-pin Wafer, 1.0mm pitch

Connector location: J6

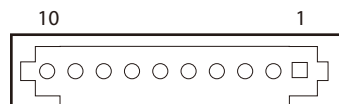

Pin	Definition	Pin	Definition
1	DCD1	2	RXD1
3	TXD1	4	DTR1
5	GND	6	DSR1
7	RTS1	8	CTS1
9	RI1	10	GND

### COM Port 2 (RS232/RS422/RS485)

Connector type: 1x10 10-pin header, 1.0mm pitch

Connector location: J4

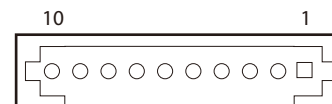

Pin	Definition	Pin	Definition
1	DCD2	2	RXD2
3	TXD2	4	DTR2
5	GND	6	DSR2
7	RTS2	8	CTS2
9	RI2	10	GND

### COM Port 3 (RS232)

Connector type: 1x10 10-pin header, 1.0mm pitch

Connector location: J5

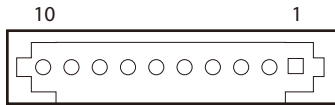

Pin	Definition	Pin	Definition
1	DCD3	2	RXD3
3	TXD3	4	DTR3
5	GND	6	DSR3
7	RTS3	8	CTS3
9	RI3	10	GND

### COM Port 4 (RS232)

Connector type: 1x10 10-pin header, 1.0mm pitch

Connector location: J7

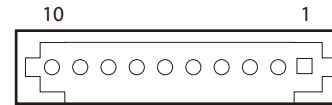

Pin	Definition	Pin	Definition
1	DCD4	2	RXD4
3	TXD4	4	DTR4
5	GND	6	DSR4
7	RTS4	8	CTS4
9	RI4	10	GND

## Mic-in Connector

Connector type: 1x4 4-pin header, 2.0mm pitch

Connector location: JP9



Pin	Definition
1	MIC1_L
2	GND
3	MIC_JD
4	MIC1_R

## Line-out Connector

Connector type: 1x4 4-pin header, 2.0mm pitch

Connector location: JP10



Pin	Definition
1	LOUT_L
2	GND
3	LOUT_JD
4	LOUT_R

## Speaker-out Connector

Connector type: 1x5 5-pin header, 2.0mm pitch

Connector location: JP8



Pin	Definition	Pin	Definition
1	FRONT_L+	2	FRONT_L-
3	GND	4	FRONT_R+
5	FRONT_R		

## LVDS Connector A

Connector type: 2x10 20-pin header, 1.25mm pitch

Connector location: CN4

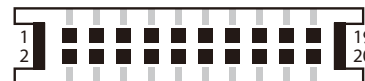

Pin	Definition	Pin	Definition
1	LVDS_DDC_CLK	2	LVDS_DDC_DATA
3	Panel_VDD	4	LVDSA_DATA0
5	LVDSA_DATA3	6	LVDSA_DATA3
7	LVDSA_DATA#3	8	Panel_VDD
9	Panel_VDD	10	LVDSA_DATA1
11	LVDSA_CLK	12	LVDSA_DATA#1
13	LVDSA_CLK#	14	GND
15	GND	16	Panel Inverter 12V
17	LVDSA_DATA2	18	Panel_backlight
19	LVDSA_DATA#2	20	GND

## LVDS Connector B

Connector type: 2x10 20-pin header, 1.25mm pitch  
Connector location: CN6

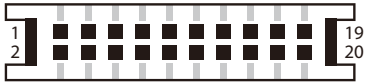

Pin	Definition	Pin	Definition
1	LVDS_DDC_CLK	2	LVDS_DDC_DATA
3	Panel_VDD	4	LVDSB_DATA0
5	LVDSB_DATA3	6	LVDSB_DATA#0
7	LVDSB_DATA#3	8	Panel_VDD
9	GND	10	LVDSB_DATA1
11	LVDSB_CLK	12	LVDSB_DATA#1
13	LVDSB_CLK#	14	GND
15	GND	16	Panel Inverter 12V
17	LVDSB_DATA2	18	Panel_backlight
19	LVDSB_DATA#2	20	GND

## LVDS Panel Inverter Connector

Connector type: 1x7 JST, 7-pin header, 2.0mm pitch  
Connector location: J1

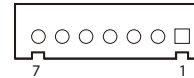

Pin	Definition	Pin	Definition
1	VCC5	2	+12V
3	+12V	4	Panel Backlight Brightness Control
5	GND	6	GND
7	Panel Backlight Enable		

## Mini-PCIe Slot (Wi-Fi)

Connector location: CN7

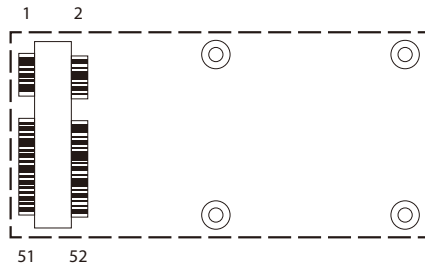

Pin	Definition	Pin	Definition
1	WAKE#	2	+3VSB
3	NC	4	GND
5	NC	6	+1.5V
7	CLKREQ#	8	NC
9	GND	10	NC
11	REF CLK-	12	NC
13	REF CLK+	14	NC
15	GND	16	NC
17	NC	18	GND
19	NC	20	Disable#
21	GND	22	PERST#
23	PCIERX1N	24	+3VSB
25	PCIERX1P	26	GND

Pin	Definition	Pin	Definition
27	GND	28	+1.5V
29	GND	30	SMBCLK
31	PCIETX-	32	SMBDATA
33	PCIETX+	34	GND
35	GND	36	USB_ON
37	GND	38	USB_OP
39	+3VSB	40	GND
41	+3VSB	42	NC
43	GND	44	NC
45	NC	46	NC
47	NC	48	+1.5V
49	NC	50	GND
51	NC	52	+3VSB

## Mini-PCIe Slot (3G)

Connector location: CN10

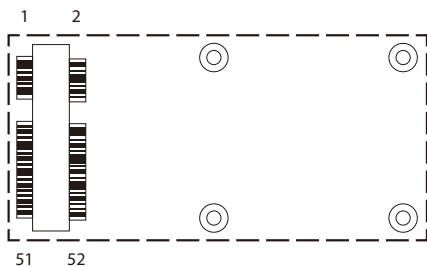

Pin	Definition	Pin	Definition
1	WAKE#	2	+3VSB
3	NC	4	GND
5	NC	6	+1.5V
7	CLKREQ#	8	UIM_PWR
9	GND	10	UIM_DATA
11	REF CLK-	12	UIM_CLK
13	REF CLK+	14	UIM_RESET
15	GND	16	UIM_VPP
17	NC	18	GND
19	NC	20	Disable#
21	GND	22	PERST#
23	PCIERX1N	24	+3VSB
25	PCIERX1P	26	GND

Pin	Definition	Pin	Definition
27	GND	28	+1.5V
29	GND	30	SMBCLK
31	PCIETX-	32	SMBDATA
33	PCIETX+	34	GND
35	GND	36	USB_1N
37	GND	38	USB_1P
39	+3VSB	40	GND
41	+3VSB	42	NC
43	GND	44	NC
45	NC	46	NC
47	NC	48	+1.5V
49	NC	50	GND
51	NC	52	+3VSB

## SIM Card Connector

Connector type: SIM card slot and 2x3 6-pin header, 2.0mm pitch

Connector location: CN9 and JP5 (co-layout)

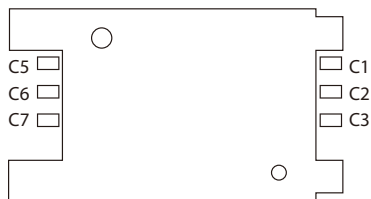

### CN7

Pin	Definition	Pin	Definition
C1	UIM_PWR	C2	UIM_RESET
C3	UIM_CLK	C5	GND
C6	UIM_VPP	C7	UIM_DATA

### JP5

Pin	Definition	Pin	Definition
1	UIM_PWR	2	GND
3	UIM_RESET	4	UIM_VPP
5	UIM_CLK	6	UIM_DATA

## SATA Connector A

Connector type: Standard Serial ATA 7P (1.27mm, SATA-M-180)

Connector location: CN3

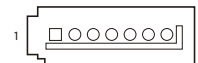

Pin	Definition	Pin	Definition
1	GND	2	SATA_TXP0
3	SATA_TXN0	4	GND
5	SATA_RXN0	6	SATA_RXP0
7	GND		



## SATA DOM Connector

Connector type: Standard Serial ATA 7P (1.27mm, SATA-M-180)

Connector location: CN5

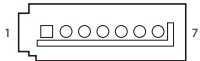

Pin	Definition	Pin	Definition
1	GND	2	SATA_TXP1
3	SATA_TXN1	4	GND
5	SATA_RXN1	6	SATA_RXP1
7	GND		

## SATA Power Connector

Connector type: 1x4 4-pin Wafer, 2.54mm pitch

Connector location: CN2



Pin	Definition
1	12V
2	GND
3	GND
4	VCC5

## SATA DOM Power Connector

Connector type: 1x2 JST, 2-pin header, 2.5mm pitch

Connector location: J2



Pin	Definition
1	VCC5
2	GND

## Power/HDD LED Connector

Connector type: 2x2 4-pin header, 2.0mm pitch

Connector location: JP4

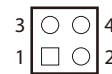

Pin	Definition
1	PWRLEDP
2	GND
3	HDDLEDP
4	GND

# Block Diagram

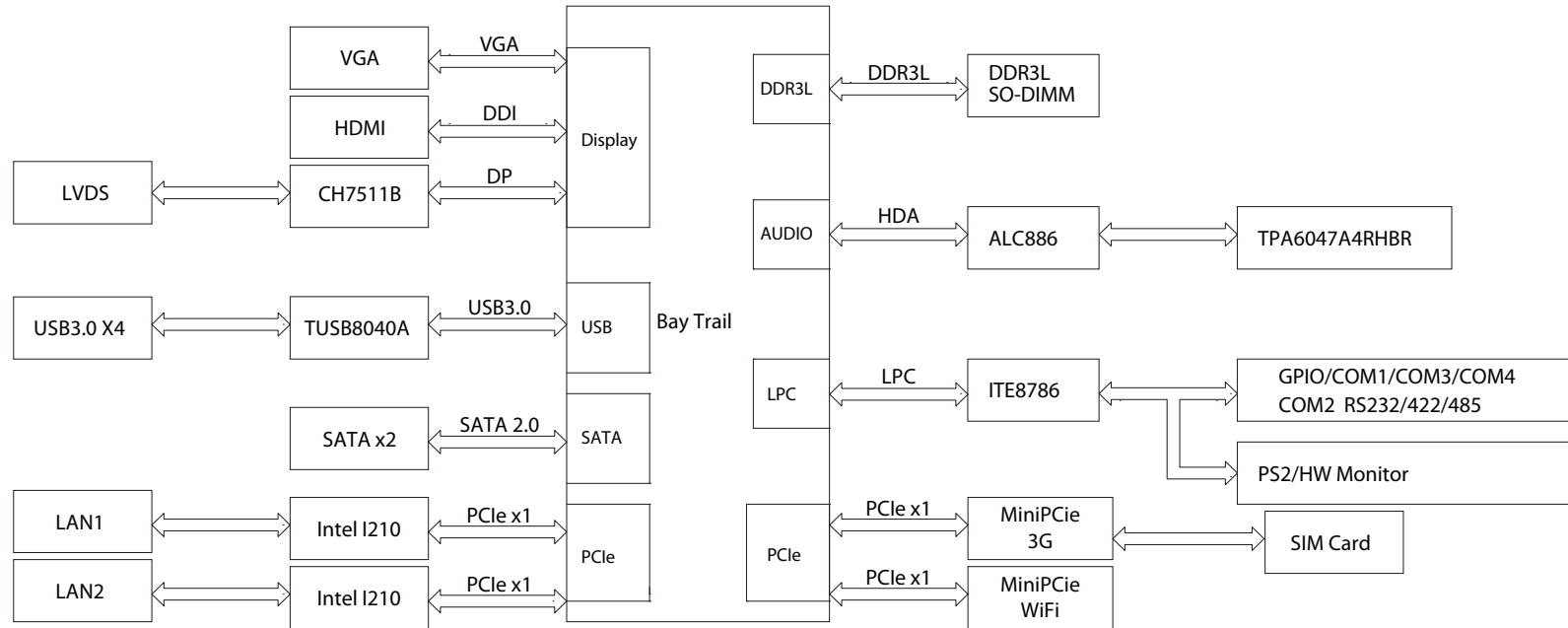

# Chapter 3: BIOS Setup

This chapter describes how to use the BIOS setup program for the EBC 355. The BIOS screens provided in this chapter are for reference only and may change if the BIOS is updated in the future.

To check for the latest updates and revisions, visit the NEXCOM Web site at [www.nexcom.com.tw](http://www.nexcom.com.tw).

## About BIOS Setup

The BIOS (Basic Input and Output System) Setup program is a menu driven utility that enables you to make changes to the system configuration and tailor your system to suit your individual work needs. It is a ROM-based configuration utility that displays the system's configuration status and provides you with a tool to set system parameters.

These parameters are stored in non-volatile battery-backed-up CMOS RAM that saves this information even when the power is turned off. When the system is turned back on, the system is configured with the values found in CMOS.

With easy-to-use pull down menus, you can configure such items as:

- Hard drives, diskette drives, and peripherals
- Video display type and display options
- Password protection from unauthorized use
- Power management features

The settings made in the setup program affect how the computer performs. It is important, therefore, first to try to understand all the setup options, and second, to make settings appropriate for the way you use the computer.

## When to Configure the BIOS

This program should be executed under the following conditions:

- When changing the system configuration
- When a configuration error is detected by the system and you are prompted to make changes to the setup program
- When resetting the system clock
- When redefining the communication ports to prevent any conflicts
- When making changes to the Power Management configuration
- When changing the password or making other changes to the security setup

Normally, CMOS setup is needed when the system hardware is not consistent with the information contained in the CMOS RAM, whenever the CMOS RAM has lost power, or the system features need to be changed.

## Default Configuration

Most of the configuration settings are either predefined according to the Load Optimal Defaults settings which are stored in the BIOS or are automatically detected and configured without requiring any actions. There are a few settings that you may need to change depending on your system configuration.

## Entering Setup

When the system is powered on, the BIOS will enter the Power-On Self Test (POST) routines. These routines perform various diagnostic checks; if an error is encountered, the error will be reported in one of two different ways:

- If the error occurs before the display device is initialized, a series of beeps will be transmitted.
- If the error occurs after the display device is initialized, the screen will display the error message.

Powering on the computer and immediately pressing <Del> allows you to enter Setup. Another way to enter Setup is to power on the computer and wait for the following message during the POST:

TO ENTER SETUP BEFORE BOOT PRESS + +

Press the key to enter Setup:

## Legends

Key	Function
	Moves the highlight left or right to select a menu.
	Moves the highlight up or down between sub-menu or fields.
	Exits the BIOS Setup Utility.
	Scrolls forward through the values or options of the highlighted field.
	Scrolls backward through the values or options of the highlighted field.
	Selects a field.
	Displays General Help.
	Load previous values.
	Load optimized default values.
	Saves and exits the Setup program.
	Press <Enter> to enter the highlighted sub-menu

### Scroll Bar

When a scroll bar appears to the right of the setup screen, it indicates that there are more available fields not shown on the screen. Use the up and down arrow keys to scroll through all the available fields.

### Submenu

When “▶” appears on the left of a particular field, it indicates that a submenu which contains additional options are available for that field. To display the submenu, move the highlight to that field and press  .

## BIOS Setup Utility

Once you enter the AMI BIOS Setup Utility, the Main Menu will appear on the screen. The main menu allows you to select from several setup functions and one exit. Use arrow keys to select among the items and press  to accept or enter the submenu.

### Main

The Main menu is the first screen that you will see when you enter the BIOS Setup Utility.



### Advanced

The Advanced menu allows you to configure your system for basic operation. Some entries are defaults required by the system board, while others, if enabled, will improve the performance of your system or let you set some features according to your preference.



Setting incorrect field values may cause the system to malfunction.



## IT8786E Super IO Configuration

This section is used to configure the serial ports.



### Super IO Chip

Displays the Super I/O chip used on the board.

## Serial Port 1 Configuration

This section is used to configure serial port 1.

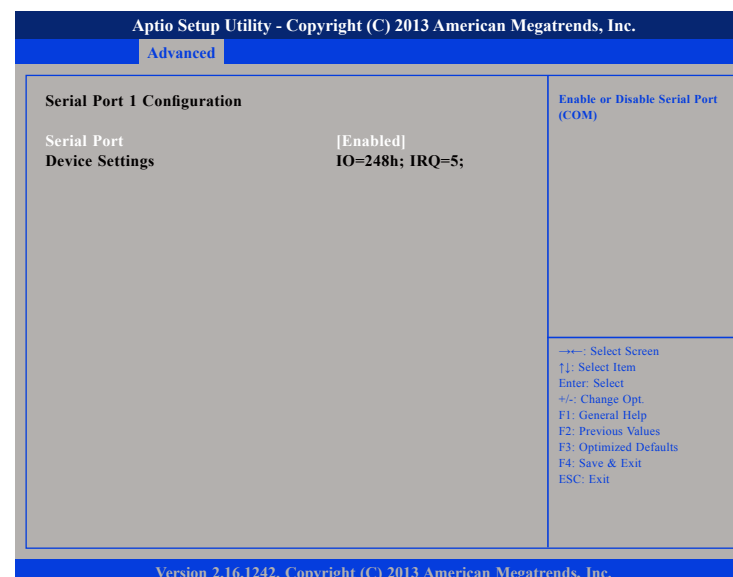

### Serial Port

Enables or disables the serial port.

### Change Settings

Selects an optimal setting for the Super IO device.

### Onboard Serial Port Max Baud Rate

Select this to change the max baud rate of the serial port.



## Serial Port 2 Configuration

This section is used to configure serial port 2.



### Serial Port

Enables or disables the serial port.

### Onboard Serial Port Mode

Select this to change the serial port mode to RS232, RS422 or RS485.

## Serial Port 3 Configuration

This section is used to configure serial port 3.

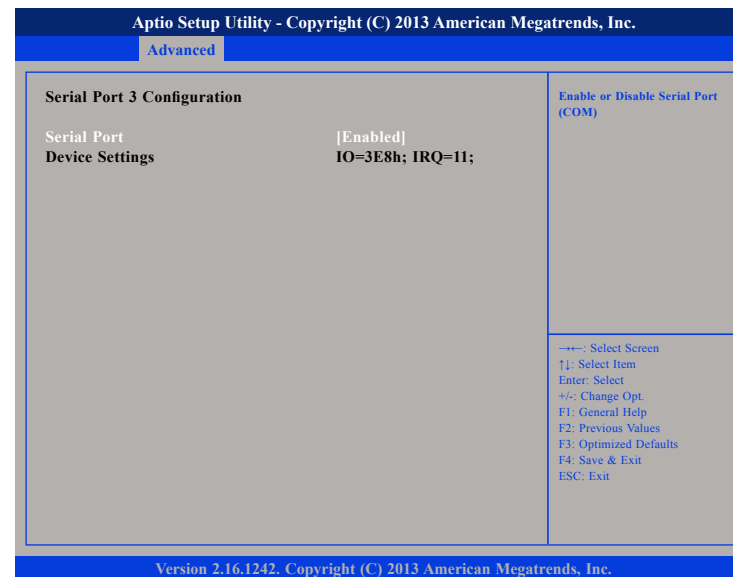

### Serial Port

Enables or disables the serial port.

## Serial Port 4 Configuration

This section is used to configure serial port 4.



### Serial Port

Enables or disables the serial port.

## Hardware Monitor

This section is used to monitor hardware status such as temperature, fan speed and voltages.

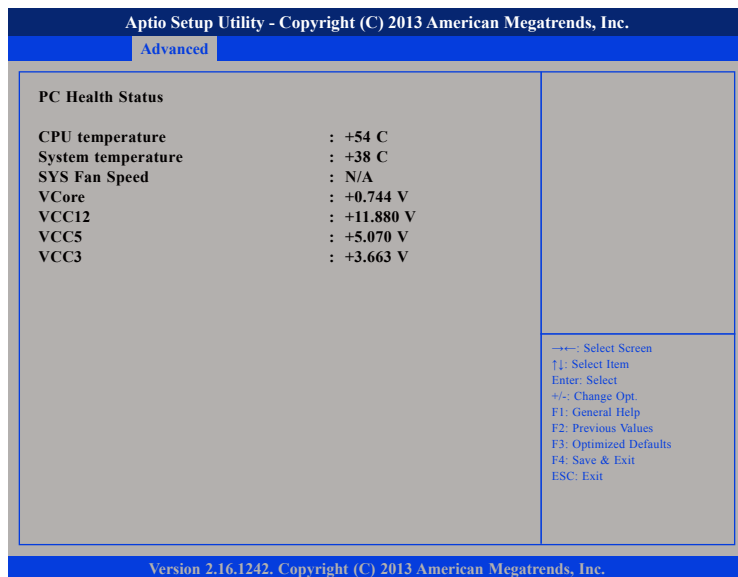

### VCore

Detects and displays the Vcore CPU voltage.

### VCC12

Detects and displays 12V voltage.

### VCC5

Detects and displays 5V voltage.

### VCC3

Detects and displays 3.3V voltage.

### CPU Temperature

Detects and displays the current CPU temperature.

### System Temperature

Detects and displays the current system temperature.

### SYS Fan Speed

Detects and displays the system fan speed.

## CPU Configuration

This section is used to configure the CPU.



### Active Processor Cores

Select the number of cores to enable in each processor package.

### Limit CPUID Maximum

The CPUID instruction of some newer CPUs will return a value greater than 3. The default is Disabled because this problem does not exist in the Windows series operating systems. If you are using an operating system other than Windows, this problem may occur. To avoid this problem, enable this field to limit the return value to 3 or lesser than 3.

### Execute Disable Bit

When this field is set to Disabled, it will force the XD feature flag to always return to 0. XD can prevent certain classes of malicious buffer overflow attacks when combined with a supporting OS (Windows Server 2003 SP1, Windows XP SP2, SuSE Linux 9.2, RedHat Enterprise 3 Update 3).

### Intel® Virtualization Technology

When this field is set to Enabled, the VMM can utilize the additional hardware capabilities provided by Vanderpool Technology.

## PPM Configuration

This section is used to configure Intel® PPM configuration.

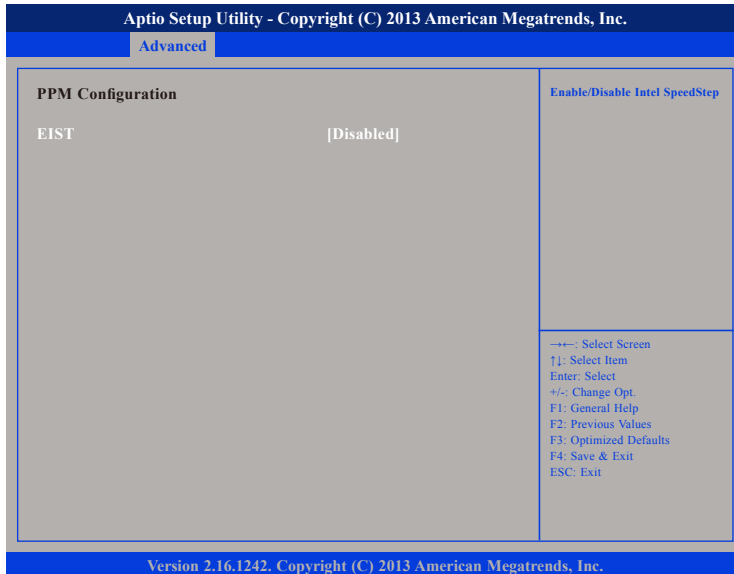

### EIST

Enables or disables Intel® SpeedStep.

## IDE Configuration

This section is used to configure the SATA drives.



### Serial-ATA (SATA)

Enables or disables the SATA device.

### SATA Speed Support

Configures the SATA controller to Gen1 or Gen2 speed.

## Configure SATA As

Configures the SATA as IDE, AHCI or RAID mode.

- IDE This option configures the Serial ATA drives as Parallel ATA physical storage device.
- RAID This option allows you to create RAID or Intel Matrix Storage configuration on Serial ATA devices.
- AHCI This option configures the Serial ATA drives to use AHCI (Advanced Host Controller Interface). AHCI allows the storage driver to enable the advanced Serial ATA features which will increase storage performance.

### Serial-ATA Port 0 and Serial-ATA Port 1

Enables or disables SATA port 0 and SATA port 1.

### SATA Port1 Hotplug and SATA Port2 Hotplug

Enables or disables hotplug support on SATA port 1 and SATA port 2.

## USB Configuration

This section is used to configure the USB.



### Legacy USB Support

Enable Enables Legacy USB.  
 Auto Disables support for Legacy when no USB devices are connected.  
 Disable Keeps USB devices available only for EFI applications.

### USB3.0 Support

Enables or disables USB 3.0 controller support.

### XHCI Hand-off and EHCI Hand-off

This is a workaround for OSs that does not support XHCI hand-off and EHCI Hand-off. The XHCI and EHCI ownership change should be claimed by the XHCI and EHCI driver respectively.

## Chipset

This section gives you functions to configure the system based on the specific features of the chipset. The chipset manages bus speeds and access to system memory resources.

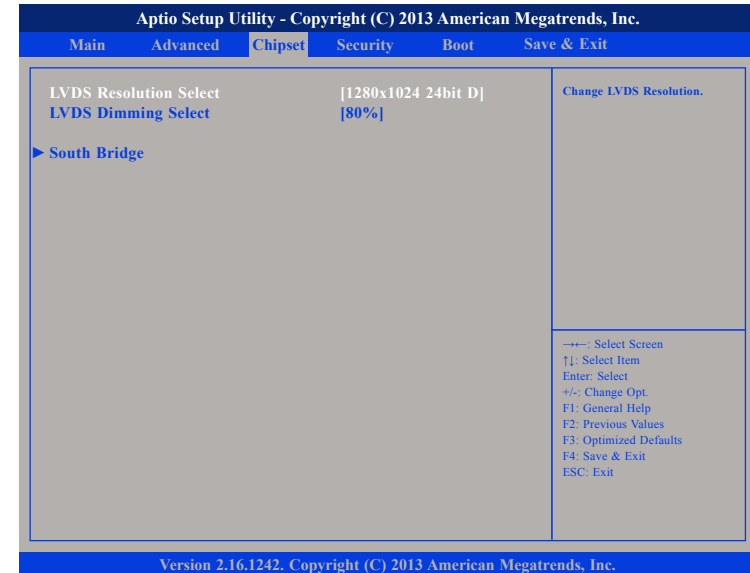

### LVDS Resolution Select

Configures the resolution of the LVDS.

### LVDS Dimming Select

Adjusts the brightness of the LVDS backlight.

## South Bridge

This section is used to configure the south bridge features.



### High Precision Timer

Enables or disables the high precision event timer.

### Restore AC Power Loss

- |            |  |
|------------|--|
| Power Off  | When power returns after an AC power failure, the system's power is off. You must press the Power button to power-on the system.   |
| Power On   | When power returns after an AC power failure, the system will automatically power-on.  |
| Last State | When power returns after an AC power failure, the system will return to the state where you left off before power failure occurs. If the system's power is off when AC power failure occurs, it will remain off when power returns. If the system's power is on when AC power failure occurs, the system will power-on when power returns. |



## PCH Azalia Configuration



### Azalia

Control detection of the Azalia device.

- Disabled Azalia will be unconditionally disabled.
- Enabled Azalia will be unconditionally Enabled.

### Azalia HDMI Codec

Enables or disables internal HDMI codec for Azalia.

## USB Configuration

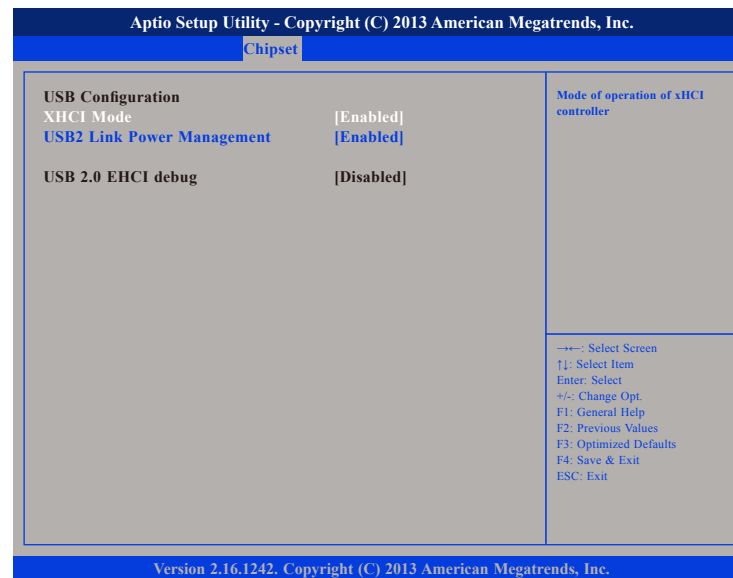

### XHCI Mode

Enables or disables XHCI mode.

### USB2 Link Power Management

Enables or disables USB link power management.

## PCI Express Configuration

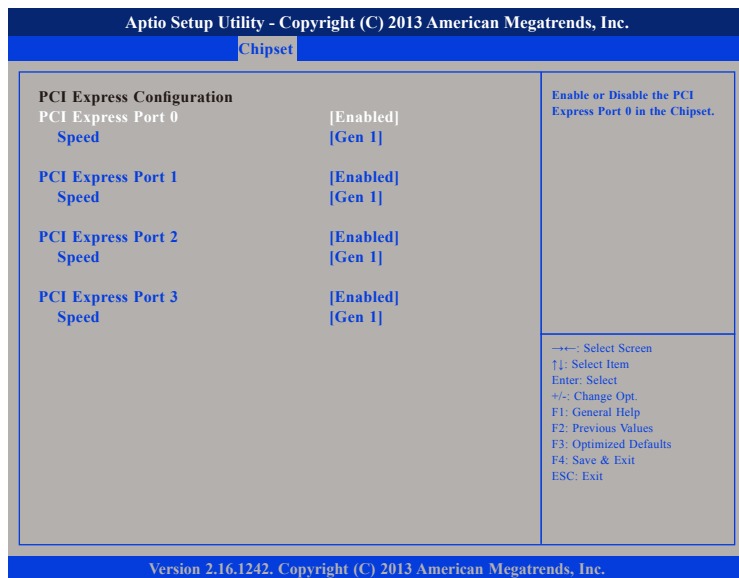

### PCI Express Port 0 to PCI Express Port 3

Enables or disables the PCI Express ports 0 to 3 on the chipset.

### Speed

Configures the PCI Express speed of ports 0 to 3.

## Security



### Administrator Password

Select this to reconfigure the administrator's password.

### User Password

Select this to reconfigure the user's password.

## Boot

This section is used to configure the boot features.

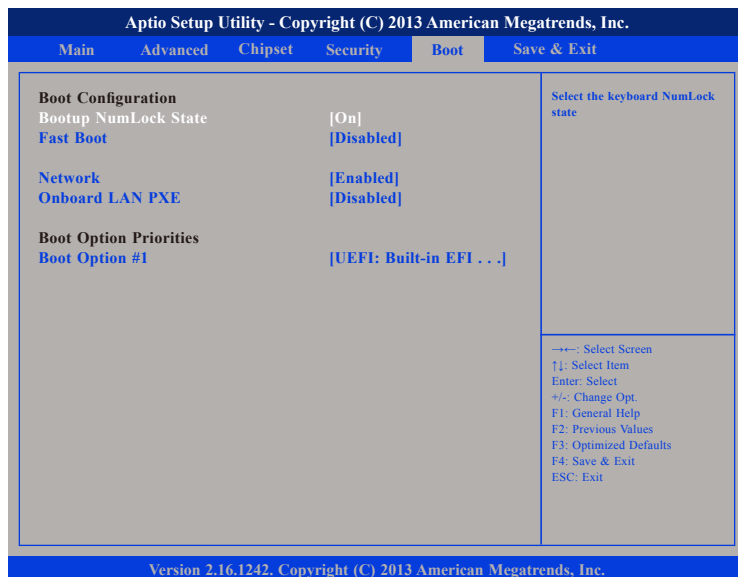

### Bootup NumLock State

This allows you to determine the default state of the numeric keypad. By default, the system boots up with NumLock on wherein the function of the numeric keypad is the number keys. When set to Off, the function of the numeric keypad is the arrow keys.

### Fast Boot

When enabled, the BIOS will shorten or skip some check items during POST. This will decrease the time needed to boot the system.

### Network

Controls the execution of UEFI and legacy PXE OpROM.

### Onboard LAN PXE

Enables or disables onboard LAN PXE ROM.

### Boot Option Priorities

Adjust the boot sequence of the system. Boot Option #1 is the first boot device that the system will boot from, next will be #2 and so forth.

## Save & Exit



### Save Changes and Reset

To save the changes and reset, select this field then press <Enter>. A dialog box will appear. Confirm by selecting Yes.

### Discard Changes and Reset

To exit the Setup utility without saving the changes, select this field then press <Enter>. You may be prompted to confirm again before exiting.

### Restore Defaults

To restore the BIOS to default settings, select this field then press <Enter>. A dialog box will appear. Confirm by selecting Yes.

# Appendix A: Watchdog Timer Setting

## EBC 355 WatchDog Programming Guide

```
#define SUPERIO_PORT    0x2E
#define WDT_SET        0x72
#define WDT_VALUE      0x73

void main(void)
{
    #Enter SuperIO Configuration
    outputb(SUPERIO_PORT, 0x87);
    outputb(SUPERIO_PORT, 0x01);
    outputb(SUPERIO_PORT, 0x55);
    outputb(SUPERIO_PORT, 0x55);

    # Set LDN
    outputb(SUPERIO_PORT, 0x07);
    outputb(SUPERIO_PORT+1 ,0x07);

    # Set WDT setting
    outputb(SUPERIO_PORT, WDT_SET);
    outputb(SUPERIO_PORT+1, 0xC0);           # Use the second
                                           # Use the minute, change value to 0x40

    # Set WDT sec/min
    outputb(SUPERIO_PORT, WDT_VALUE);
    outputb(SUPERIO_PORT+1, 0x05);         #Set 5 seconds
}
```

# Appendix B: GPIO Programming Guide

GPIO (General Purpose Input/Output) pins are provided for custom system design. This appendix provides definitions and its default setting for the ten GPIO pins. The pin definition is shown in the following table:

Pin	GPIO mode	PowerOn Default	Address	Pin	GPIO mode	PowerOn Default	Address
1	VCC	-	-	2	GND	-	-
3	GPO0	Low	A03h (Bit6)	4	GPIO	High	A03h (Bit1)
5	GPO1	Low	A02h (Bit5)	6	GPI1	High	A05h (Bit5)
7	GPO2	Low	A07h (Bit0)	8	GPI2	High	A05h (Bit4)
9	GPO3	Low	A07h (Bit1)	10	GPI3	High	A00h (Bit1)

Control the GPIO pin 3 level from I/O port A03h bit 6.

Control the GPIO pin 5 level from I/O port A02h bit 5.

Control the GPIO pin 7 level from I/O port A07h bit 0.

Control the GPIO pin 9 level from I/O port A07h bit 1.

The bit is Set/Clear indicated output High/Low.

## GPIO programming sample code

```
#define GPIO_PORT1    0xA03
#define GPIO_PORT2    0xA02
#define GPIO_PORT3    0xA07
#define GPO0          (0x01 << 6)
#define GPO1          (0x01 << 5)
#define GPO2          (0x01 << 0)
#define GPO3          (0x01 << 1)

#define GPO0_HI      outportb(GPIO_PORT1, GPO0)
#define GPO0_LO      outportb(GPIO_PORT1, 0x00)
#define GPO1_HI      outportb(GPIO_PORT2, GPO1)
#define GPO1_LO      outportb(GPIO_PORT2, 0x00)
#define GPO2_HI      outportb(GPIO_PORT3, GPO2)
#define GPO2_LO      outportb(GPIO_PORT3, 0x00)
#define GPO3_HI      outportb(GPIO_PORT3, GPO3)
#define GPO3_LO      outportb(GPIO_PORT3, 0x00)
void main(void)
{
    GPO0_HI;
    GPO1_LO;
    GPO2_HI;
    GPO3_LO;
}
```