



NEXCOM International Co., Ltd.

Multi-Media Solutions

Digital Signage Platform

NDiS M324

User Manual

Contents

Preface

Copyright	iv
Disclaimer	iv
Acknowledgements	iv
Regulatory Compliance Statements	iv
Declaration of Conformity	iv
RoHS Compliance	v
Warranty and RMA	vi
Safety Information	viii
Installation Recommendations	viii
Safety Precautions	ix
Technical Support and Assistance	x
Conventions Used in this Manual	x
Global Service Contact Information	xi
Package Contents	xiii
Ordering Information	xiv

Chapter 1: Product Introduction

Overview	1
Key Features	1
Physical Features	2
Front Panel	2
Rear Panel	2
Hardware Specifications	3
Mechanical Dimensions	4

Chapter 2: Jumpers and Connectors

Before You Begin	5
Precautions	5
Locations of the Jumpers and Connectors for NDiB M324	6
NDiB M324	6
Top View	6
Bottom View	7
Jumper Settings	8
Jumpers	9
CMOS Clear Select	9
Connector Pin Definitions	10
External I/O Interfaces	10
LED Connector	10
Power Button	10
Reset Button	11
Line-out Connector	11
Line-in Connector	12
USB 3.0 Ports	12
USB 3.0 and USB 2.0 Port	13
HDMI	13
LAN Port	14
JAE-TX25	15
Internal Connectors	16
Mini-PCIe Connector	16
SATA Connector (7-pin and 15-pin)	17
Battery Connector	17



Debug Port	18
FAN Connector	18
SIM Card Slot.....	19

Chapter 3: System Setup

Removing the Chassis Cover	20
Installing a SO-DIMM.....	21
Installing to DIMM2 Slot (Primary).....	21
Installing to DIMM1 Slot (Secondary)	23
Installing a 2.5" HDD Storage	26
Installing a Wireless LAN Module	27
Installing a 3G Module.....	31

Chapter 4: BIOS Setup

About BIOS Setup.....	33
When to Configure the BIOS.....	33
Default Configuration	34
Entering Setup	34
Legends.....	34
BIOS Setup Utility.....	36
Main	36
Advanced	37
Security	49
Boot.....	50
Save & Exit	50

Appendix A: Watchdog Timer.....51

Appendix B: DASH Function (Remote Management).....52

Preface

Copyright

This publication, including all photographs, illustrations and software, is protected under international copyright laws, with all rights reserved. No part of this manual may be reproduced, copied, translated or transmitted in any form or by any means without the prior written consent from NEXCOM International Co., Ltd.

Disclaimer

The information in this document is subject to change without prior notice and does not represent commitment from NEXCOM International Co., Ltd. However, users may update their knowledge of any product in use by constantly checking its manual posted on our website: <http://www.nexcom.com>. NEXCOM shall not be liable for direct, indirect, special, incidental, or consequential damages arising out of the use of any product, nor for any infringements upon the rights of third parties, which may result from such use. Any implied warranties of merchantability or fitness for any particular purpose is also disclaimed.

Acknowledgements

NDiS M324 is a trademark of NEXCOM International Co., Ltd. All other product names mentioned herein are registered trademarks of their respective owners.

Regulatory Compliance Statements

This section provides the FCC compliance statement for Class B devices and describes how to keep the system CE compliant.

Declaration of Conformity

FCC

This equipment has been tested and verified to comply with the limits for a Class B digital device, pursuant to Part 15 of FCC Rules. These limits are designed to provide reasonable protection against harmful interference when the equipment is operated in a commercial environment. This equipment generates, uses, and can radiate radio frequency energy and, if not installed and used in accordance with the instructions, may cause harmful interference to radio communications. Operation of this equipment in a residential area (domestic environment) is likely to cause harmful interference, in which case the user will be required to correct the interference (take adequate measures) at their own expense.

CE

The product(s) described in this manual complies with all applicable European Union (CE) directives if it has a CE marking. For computer systems to remain CE compliant, only CE-compliant parts may be used. Maintaining CE compliance also requires proper cable and cabling techniques.

RoHS Compliance



NEXCOM RoHS Environmental Policy and Status Update

NEXCOM is a global citizen for building the digital infrastructure. We are committed to providing green products and services, which are compliant with European Union RoHS (Restriction on Use of Hazardous Substance in Electronic Equipment) directive 2011/65/EU, to be your trusted green partner and to protect our environment.

RoHS restricts the use of Lead (Pb) < 0.1% or 1,000ppm, Mercury (Hg) < 0.1% or 1,000ppm, Cadmium (Cd) < 0.01% or 100ppm, Hexavalent Chromium (Cr6+) < 0.1% or 1,000ppm, Polybrominated biphenyls (PBB) < 0.1% or 1,000ppm, and Polybrominated diphenyl Ethers (PBDE) < 0.1% or 1,000ppm.

In order to meet the RoHS compliant directives, NEXCOM has established an engineering and manufacturing task force to implement the introduction of green products. The task force will ensure that we follow the standard NEXCOM development procedure and that all the new RoHS components and new manufacturing processes maintain the highest industry quality levels for which NEXCOM are renowned.

The model selection criteria will be based on market demand. Vendors and suppliers will ensure that all designed components will be RoHS compliant.

How to recognize NEXCOM RoHS Products?

For existing products where there are non-RoHS and RoHS versions, the suffix "(LF)" will be added to the compliant product name.

All new product models launched after January 2013 will be RoHS compliant. They will use the usual NEXCOM naming convention.

Warranty and RMA

NEXCOM Warranty Period

NEXCOM manufactures products that are new or equivalent to new in accordance with industry standard. NEXCOM warrants that products will be free from defect in material and workmanship for 2 years, beginning on the date of invoice by NEXCOM. HCP series products (Blade Server) which are manufactured by NEXCOM are covered by a three year warranty period.

NEXCOM Return Merchandise Authorization (RMA)

- Customers shall enclose the “NEXCOM RMA Service Form” with the returned packages.
- Customers must collect all the information about the problems encountered and note anything abnormal or, print out any on-screen messages, and describe the problems on the “NEXCOM RMA Service Form” for the RMA number apply process.
- Customers can send back the faulty products with or without accessories (manuals, cable, etc.) and any components from the card, such as CPU and RAM. If the components were suspected as part of the problems, please note clearly which components are included. Otherwise, NEXCOM is not responsible for the devices/parts.
- Customers are responsible for the safe packaging of defective products, making sure it is durable enough to be resistant against further damage and deterioration during transportation. In case of damages occurred during transportation, the repair is treated as “Out of Warranty.”
- Any products returned by NEXCOM to other locations besides the customers’ site will bear an extra charge and will be billed to the customer.

Repair Service Charges for Out-of-Warranty Products

NEXCOM will charge for out-of-warranty products in two categories, one is basic diagnostic fee and another is component (product) fee.

Repair Service Charges for Out-of-Warranty Products

NEXCOM will charge for out-of-warranty products in two categories, one is basic diagnostic fee and another is component (product) fee.

System Level

- Component fee: NEXCOM will only charge for main components such as SMD chip, BGA chip, etc. Passive components will be repaired for free, ex: resistor, capacitor.
- Items will be replaced with NEXCOM products if the original one cannot be repaired. Ex: motherboard, power supply, etc.
- Replace with 3rd party products if needed.
- If RMA goods can not be repaired, NEXCOM will return it to the customer without any charge.

Board Level

- Component fee: NEXCOM will only charge for main components, such as SMD chip, BGA chip, etc. Passive components will be repaired for free, ex: resistors, capacitors.
- If RMA goods can not be repaired, NEXCOM will return it to the customer without any charge.

Warnings

Read and adhere to all warnings, cautions, and notices in this guide and the documentation supplied with the chassis, power supply, and accessory modules. If the instructions for the chassis and power supply are inconsistent with these instructions or the instructions for accessory modules, contact the supplier to find out how you can ensure that your computer meets safety and regulatory requirements.

Cautions

Electrostatic discharge (ESD) can damage system components. Do the described procedures only at an ESD workstation. If no such station is available, you can provide some ESD protection by wearing an antistatic wrist strap and attaching it to a metal part of the computer chassis.

Safety Information

Before installing and using the device, note the following precautions:

- Read all instructions carefully.
- Do not place the unit on an unstable surface, cart, or stand.
- Follow all warnings and cautions in this manual.
- When replacing parts, ensure that your service technician uses parts specified by the manufacturer.
- Avoid using the system near water, in direct sunlight, or near a heating device.
- The load of the system unit does not solely rely for support from the rackmounts located on the sides. Firm support from the bottom is highly necessary in order to provide balance stability.
- The computer is provided with a battery-powered real-time clock circuit. There is a danger of explosion if battery is incorrectly replaced. Replace only with the same or equivalent type recommended by the manufacturer. Discard used batteries according to the manufacturer's instructions.

Installation Recommendations

Ensure you have a stable, clean working environment. Dust and dirt can get into components and cause a malfunction. Use containers to keep small components separated.

Adequate lighting and proper tools can prevent you from accidentally damaging the internal components. Most of the procedures that follow require only a few simple tools, including the following:

- A Philips screwdriver
- A flat-tipped screwdriver
- A grounding strap
- An anti-static pad

Using your fingers can disconnect most of the connections. It is recommended that you do not use needle-nose pliers to disconnect connections as these can damage the soft metal or plastic parts of the connectors.

Safety Precautions

1. Read these safety instructions carefully.
2. Keep this User Manual for later reference.
3. Disconnect this equipment from any AC outlet before cleaning. Use a damp cloth. Do not use liquid or spray detergents for cleaning.
4. For plug-in equipment, the power outlet socket must be located near the equipment and must be easily accessible.
5. Keep this equipment away from humidity.
6. Put this equipment on a stable surface during installation. Dropping it or letting it fall may cause damage.
7. The openings on the enclosure are for air convection to protect the equipment from overheating. **DO NOT COVER THE OPENINGS.**
8. Make sure the voltage of the power source is correct before connecting the equipment to the power outlet.
9. Place the power cord in a way so that people will not step on it. Do not place anything on top of the power cord. Use a power cord that has been approved for use with the product and that it matches the voltage and current marked on the product's electrical range label. The voltage and current rating of the cord must be greater than the voltage and current rating marked on the product.
10. All cautions and warnings on the equipment should be noted.
11. If the equipment is not used for a long time, disconnect it from the power source to avoid damage by transient overvoltage.
12. Never pour any liquid into an opening. This may cause fire or electrical shock.
13. Never open the equipment. For safety reasons, the equipment should be opened only by qualified service personnel.
14. If one of the following situations arises, get the equipment checked by service personnel:
 - a. The power cord or plug is damaged.
 - b. Liquid has penetrated into the equipment.
 - c. The equipment has been exposed to moisture.
 - d. The equipment does not work well, or you cannot get it to work according to the user's manual.
 - e. The equipment has been dropped and damaged.
 - f. The equipment has obvious signs of breakage.
15. Do not place heavy objects on the equipment.
16. The unit uses a three-wire ground cable which is equipped with a third pin to ground the unit and prevent electric shock. Do not defeat the purpose of this pin. If your outlet does not support this kind of plug, contact your electrician to replace your obsolete outlet.
17. **CAUTION: DANGER OF EXPLOSION IF BATTERY IS INCORRECTLY REPLACED. REPLACE ONLY WITH THE SAME OR EQUIVALENT TYPE RECOMMENDED BY THE MANUFACTURER. DISCARD USED BATTERIES ACCORDING TO THE MANUFACTURER'S INSTRUCTIONS.**

Technical Support and Assistance

1. For the most updated information of NEXCOM products, visit NEXCOM's website at www.nexcom.com.
2. For technical issues that require contacting our technical support team or sales representative, please have the following information ready before calling:
 - Product name and serial number
 - Detailed information of the peripheral devices
 - Detailed information of the installed software (operating system, version, application software, etc.)
 - A complete description of the problem
 - The exact wordings of the error messages

Warning!

1. Handling the unit: carry the unit with both hands and handle it with care.
2. Maintenance: to keep the unit clean, use only approved cleaning products or clean with a dry cloth.
3. CompactFlash: Turn off the unit's power before inserting or removing a CompactFlash storage card.

Conventions Used in this Manual



Warning:

Information about certain situations, which if not observed, can cause personal injury. This will prevent injury to yourself when performing a task.



Caution:

Information to avoid damaging components or losing data.



Note:

Provides additional information to complete a task easily.

Global Service Contact Information

Headquarters

NEXCOM International Co., Ltd.

15F, No. 920, Chung-Cheng Rd.,
ZhongHe District, New Taipei City, 23586,
Taiwan, R.O.C.

Tel: +886-2-8226-7786

Fax: +886-2-8226-7782

www.nexcom.com

America

USA

NEXCOM USA

2883 Bayview Drive,
Fremont CA 94538, USA

Tel: +1-510-656-2248

Fax: +1-510-656-2158

Email: sales@nexcom.com

www.nexcom.com

Asia

Taiwan

NEXCOM Intelligent Systems

Taipei Office

13F, No.920, Chung-Cheng Rd.,
ZhongHe District,
New Taipei City, 23586, Taiwan, R.O.C.

Tel: +886-2-8226-7796

Fax: +886-2-8226-7792

Email: sales@nexcom.com.tw

www.nexcom.com.tw

NEXCOM Intelligent Systems

Taichung Office

16F, No.250, Sec. 2, Chongde Rd.,
Beitun Dist.,

Taichung City 406, R.O.C.

Tel: +886-4-2249-1179

Fax: +886-4-2249-1172

Email: sales@nexcom.com.tw

www.nexcom.com.tw

Japan

NEXCOM Japan

9F, Tamachi Hara Bldg.,
4-11-5, Shiba Minato-ku,
Tokyo, 108-0014, Japan

Tel: +81-3-5419-7830

Fax: +81-3-5419-7832

Email: sales@nexcom-jp.com

www.nexcom-jp.com

China

NEXCOM China

1F & 2F, Block A, No. 16 Yonyou Software Park,
No. 68 Beiqing Road, Haidian District,
Beijing, 100094, China

Tel: +86-010-5704-2680

Fax: +86-010-5704-2681

Email: sales@nexcom.cn

www.nexcom.cn

Chengdu Office

9F, Shuxiangxie, Xuefu Garden,
No.12 Section 1, South Yihuan Rd.,
Chengdu, 610061, China
Tel: +86-28-8523-0186
Fax: +86-28-8523-0186
Email: sales@nexcom.cn
www.nexcom.cn

Shanghai Office

Room 603/604, Huiyinmingzun Plaza Bldg., 1,
No.609, Yunlin East Rd.,
Shanghai, 200333, China
Tel: +86-21-5278-5868
Fax: +86-21-3251-6358
Email: sales@nexcom.cn
www.nexcom.cn

Shenzhen Office

Room1707, North Block, Pines Bldg.,
No.7 Tairan Rd., Futian Area,
Shenzhen, 518040, China
Tel: +86-755-8332-7203
Fax: +86-755-8332-7213
Email: sales@nexcom.cn
www.nexcom.cn

Wuhan Office

1-C1804/1805, Mingze Liwan, No. 519
South Luoshi Rd., Hongshan District,
Wuhan, 430070, China
Tel: +86-27-8722-7400
Fax: +86-27-8722-7400
Email: sales@nexcom.cn
www.nexcom.cn

Europe

United Kingdom

NEXCOM EUROPE

10 Vincent Avenue,
Crownhill Business Centre,
Milton Keynes, Buckinghamshire
MK8 0AB, United Kingdom
Tel: +44-1908-267121
Fax: +44-1908-262042
Email: sales.uk@nexcom.eu
www.nexcom.eu

Italy

NEXCOM ITALIA S.r.l

Via Gaudenzio Ferrari 29,
21047 Saronno (VA), Italia
Tel: +39 02 9628 0333
Fax: +39 02 9286 9215
Email: nexcomitalia@nexcom.eu
www.nexcomitalia.it

Package Contents

Before continuing, verify that the NDiS M324 package that you received is complete. Your package should have all the items listed in the following table.

Item	Part Number	Name	Description	Qty
1	50311F0112X00	(H)Flat Head Screw Long FEI:F3x4iso	For SPC-150 M3x4mm(NYLOK) Black	2
2	50311F0295X00	Flat Head Screw Long FEI:F2x4 NYLOK NIGP	F2x4 NIGP NYLOK	2
3	5040420019X00	Mini-Card Bracket For NDiS M323 VER:A CHYUAN-JYH	29x30x2.1mm t=1.0mm SPCC+NI	1
4	6012200049X00	ASG110 PE Bag 24x38cm	240x380x0.08mm	1
5	6012200052X00	PE Zipper Bag #8	170x240mm, W/China RoHS SYMBOL	1
6	6012200053X00	PE Zipper Bag #3	100x70mm, W/China RoHS SYMBOL	1
7	602DCD0795X00	(N)NDiS M324 DVD Driver Manual VER:1.0	JCL	1

Ordering Information

The following below provides ordering information for NDiS M324.

NDiS M324 (P/N: 10W00M32400X0)

Intel® Celeron® J1900 processor SoC OPS

Test board kit (Optional)

OPS-TB-KIT (P/N: 10QOPSTB00X1)

Chapter 1: Product Introduction

Overview



NDiS M324 is based on Intel® Celeron® Processor J1900 (formerly codenamed “Bay Trail”) and follows the electrical and mechanical specifications of the Open Pluggable Specification. NDiS M324 can be plugged into any OPS-complaint display devices to render rich multimedia contents. Thanks to the modular and cable-less, NDiS M324 satisfies the need for quick deployment and hassle-free maintenance of large digital signage network dispersed in different geographical locations. NDiS M324 is powered by the Intel® Celeron® Processor J1900. The digital signage player has an integrated Intel Gen.7 graphic engine and supports Microsoft DirectX 11. Taking advantage of the latest Intel technology, NDiS M324 can accelerate, 3D rendering, image processing and video decoding to provide highly personalized information base on the result of audience measurement to deliver accurate marketing message to target audience.

Key Features

- Intel® Celeron™ Processor J1900
- Integrated Intel® Gen 7 graphics
- Dual SO-DIMM slots for up to 8GB of DDR3L 1333 memory
- WWAN/ WLAN/ TV tuner support
- Remote management
- Comply with Open Pluggable Specification
- Fanless Design

Physical Features

Front Panel

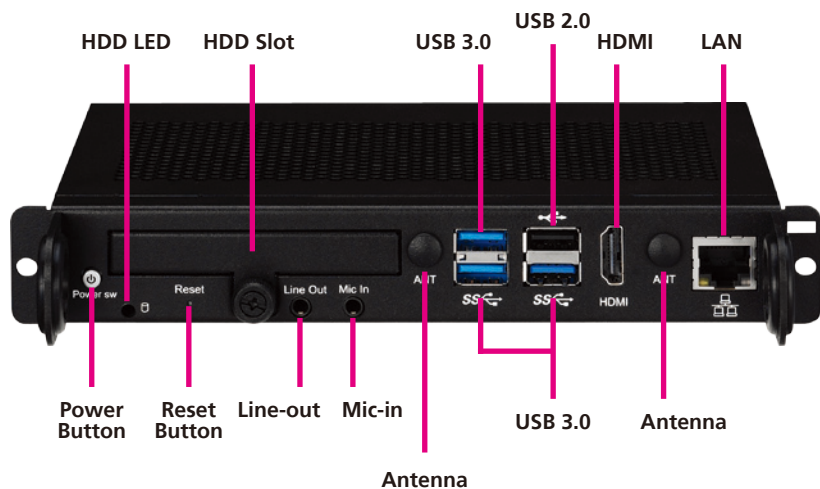

Rear Panel

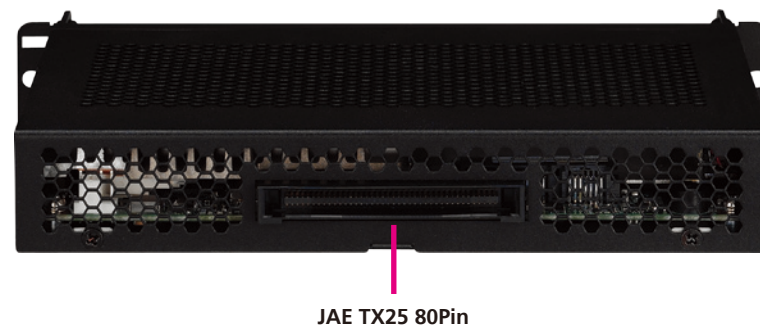

Hardware Specifications

CPU Support

- Intel® Celeron® Processor J1900 Quad Core 2.0GHz SoC processor

Graphics

- Integrated Intel® Gen 7 graphics

Main Memory

- 2x 204 pin SO-DIMM socket, support DDR3L 1333 MHz with un-buffered and non-ECC SDRAM up to 8GB

I/O Interface-Front

- 1x Power button
- 1x Reset button
- 1x HDD LED
- 3x USB 3.0
- 1x USB 2.0
- 1x HDMI
- 1x Mic-in
- 1x Line-out
- 1x 2.5" HDD slot
- 1x RJ45 with LEDs for Gigabit LAN
- 2x Antenna hole

I/O Interface-Rear

- 1x TMDS
- 1x UART
- 1x Audio out L/R
- 2x USB 2.0
- 1x USB 3.0

- DC input +12V~+19V
- Control signals (PWR_STATUS, PS_ON#, PB_DET, CEC, SYS_FAN)

Storage Device

- 1x 2.5" SATA storage bay for HDD/ SSD

Expansion

- 1x Mini-PCI for optional WLAN/ TV tuner module
- 1x SIM slot

Dimensions

- 200mm (W) x 119mm (D) x 30mm (H) (7.8" x 4.7" x 1.1")

Power Supply

- DC power input +12V~19V

Environment

- Operating temperature:
 - Ambient with air flow from 0°C to 40°C (with HDD)
 - Ambient with air flow from 0°C to 45°C (with SSD)
- Storage temperature : -20°C to 80°C
- Humidity: 10 to 90% (non-condensing)

Certification

- CE approval
- FCC Class A

Operating System

- Windows 7/ Windows 8 / WES7/ WES8 / Linux

Mechanical Dimensions

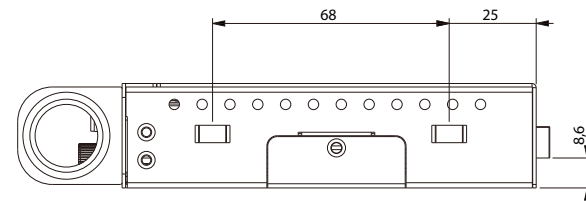
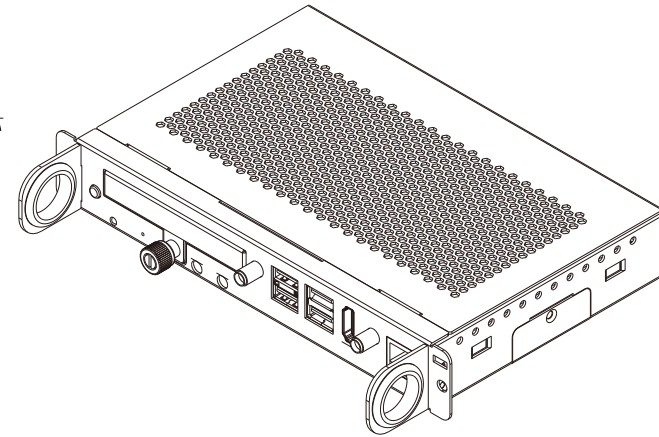
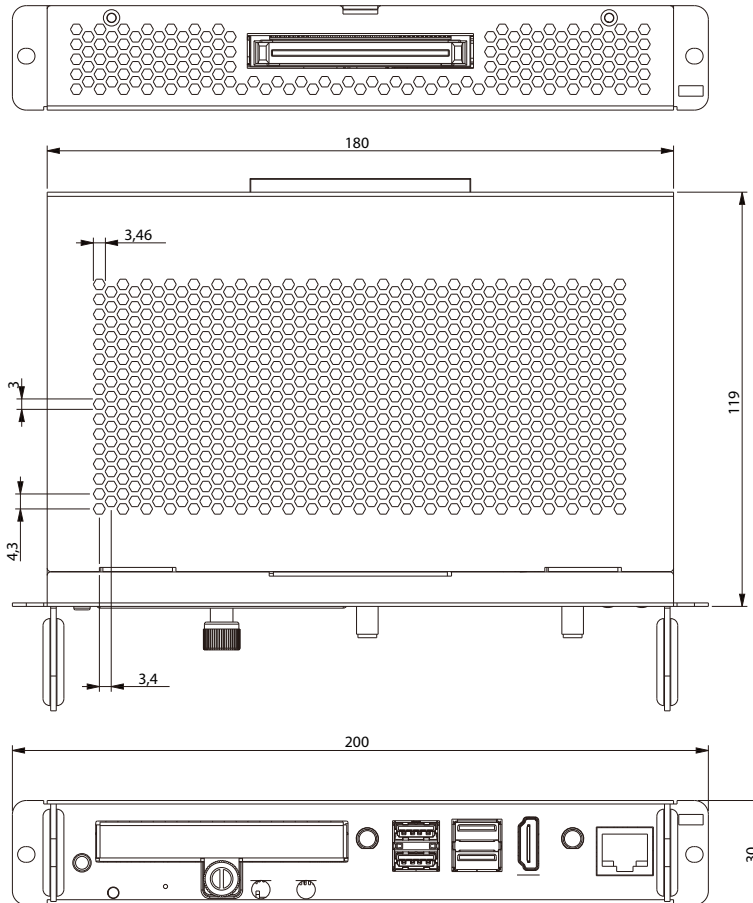

Chapter 2: Jumpers and Connectors

This chapter describes how to set the jumpers and connectors on the NDiS M324 motherboard.

Before You Begin

- Ensure you have a stable, clean working environment. Dust and dirt can get into components and cause a malfunction. Use containers to keep small components separated.
- Adequate lighting and proper tools can prevent you from accidentally damaging the internal components. Most of the procedures that follow require only a few simple tools, including the following:
 - A Philips screwdriver
 - A flat-tipped screwdriver
 - A set of jewelers screwdrivers
 - A grounding strap
 - An anti-static pad
- Using your fingers can disconnect most of the connections. It is recommended that you do not use needle-nosed pliers to disconnect connections as these can damage the soft metal or plastic parts of the connectors.
- Before working on internal components, make sure that the power is off. Ground yourself before touching any internal components, by touching a metal object. Static electricity can damage many of the electronic components. Humid environments tend to have less static electricity than

dry environments. A grounding strap is warranted whenever danger of static electricity exists.

Precautions

Computer components and electronic circuit boards can be damaged by discharges of static electricity. Working on computers that are still connected to a power supply can be extremely dangerous.

Follow the guidelines below to avoid damage to your computer or yourself:

- Always disconnect the unit from the power outlet whenever you are working inside the case.
- If possible, wear a grounded wrist strap when you are working inside the computer case. Alternatively, discharge any static electricity by touching the bare metal chassis of the unit case, or the bare metal body of any other grounded appliance.
- Hold electronic circuit boards by the edges only. Do not touch the components on the board unless it is necessary to do so. Don't flex or stress the circuit board.
- Leave all components inside the static-proof packaging that they shipped with until they are ready for installation.
- Use correct screws and do not over tighten screws.

Locations of the Jumpers and Connectors for NDiB M324

NDiB M324

The figure below is the top and bottom view of the NDiB M324 main board which is the main board used in the NDiS M324. It shows the locations of the jumpers and connectors.

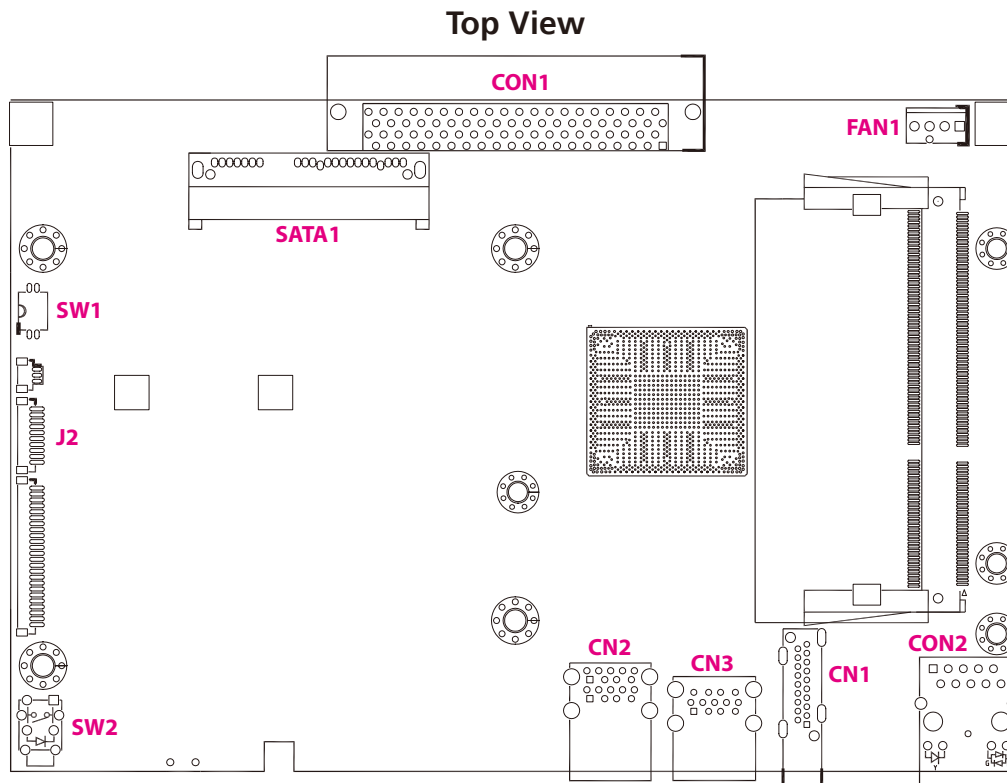

Bottom View

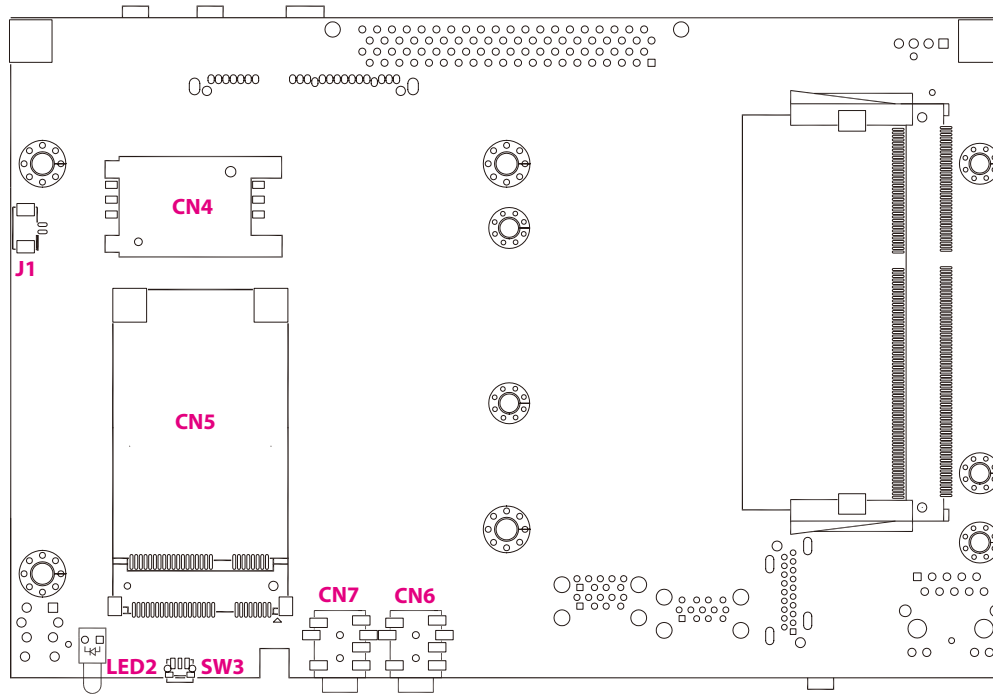

Jumper Settings

A jumper is the simplest kind of electric switch. It consists of two metal pins and a cap. When setting the jumpers, ensure that the jumper caps are placed on the correct pins. When the jumper cap is placed on both pins, the jumper is short. If you remove the jumper cap, or place the jumper cap on just one pin, the jumper is open.

Refer to the illustrations below for examples of what the 2-pin and 3-pin jumpers look like when they are short (on) and open (off).

Two-Pin Jumpers: Open (Left) and Short (Right)

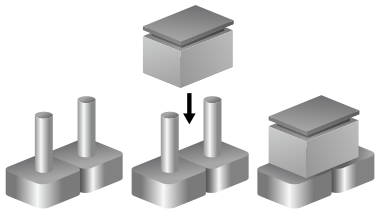

Three-Pin Jumpers: Pins 1 and 2 are Short

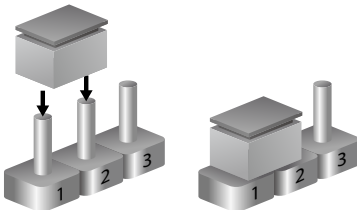

Jumpers

CMOS Clear Select

Connector type: 1x2 2-pin DIP switch

Connector location: SW1

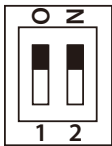

Pin	Status	Settings
OFF	Short	Normal
ON(1-4)	Short	Clear BIOS
ON(2-3)	Short	Clear ME

1-2 On: default

Connector Pin Definitions

External I/O Interfaces

LED Connector

Connector location: LED2



HDD

Pin	Definition
A	HD_LED
C	SATA_LED_V3P3#

Power Button

Connector location: SW2



Pin	Definition	Pin	Definition
1	GND	2	PWR_BTN#
3	PWR_BTN#	4	GND
A1	PWRLED_N	C1	PWRLED_P
MH1	NC	MH2	NC

Reset Button

Connector location: SW3



Pin	Definition	Pin	Definition
1	GND	2	RST_BTN#
3	GND	MH1	GND
MH2	PWRLED_N		

Line-out Connector

Connector type: 3.5mm TRS

Connector location: CN7



Pin	Definition	Pin	Definition
1	AUDGND	2	AUDGND
3	LINE_OUTR	4	LINE_OUTL
5	SURR_JD	G1,G2	AUDGND

Line-in Connector

Connector type: 3.5mm TRS

Connector location: CN6



Pin	Definition	Pin	Definition
1	AUDGND	2	AUDGND
3	LINE_INR	4	LINE_INL
5	LIMIC_JD	G1,G2	AUDGND

USB 3.0 Ports

Connector type: Dual USB 3.0 ports

Connector location: CN2

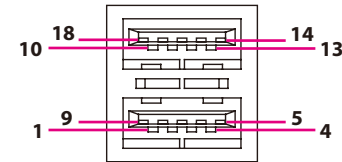

Pin	Definition	Pin	Definition
1	USB01_P5V	2	USB_DN0
3	USB_DP0	4	GND
5	USB_RX0N	6	USB_RX0P
7	GND	8	USB_TX0N
9	USB_TX0P	10	USB01_P5V
11	USB_DN1	12	USB_DP1
13	GND	14	USB_RX1N
15	USB_RX1P	16	GND
17	USB_TX1N	18	USB_TX1P
MH1	GND	MH2	GND
MH3	GND	MH4	GND

USB 3.0 and USB 2.0 Port

Connector type: USB 3.0 and USB 2.0 port

Connector location: CN3

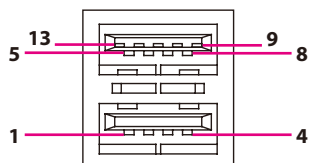

Pin	Definition	Pin	Definition
1	USB01_P5V	2	USB_DN0
3	USB_DP0	4	GND
5	USB_RX0N	6	USB_RX0P
7	GND	8	USB_TX0N
9	USB_TX0P	10	USB01_P5V
11	USB_DN1	12	USB_DP1
13	GND	MH1	GND
MH2	GND	MH3	GND
MH4	GND		

HDMI

Connector type: HDMI port

Connector location: CN1

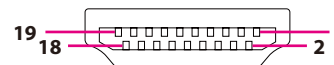

Pin	Definition	Pin	Definition
1	HDMI1_TX2P	2	GND
3	HDMI1_TX2N	4	HDMI1_TX1P
5	GND	6	HDMI1_TX1N
7	HDMI1_TX0P	8	GND
9	HDMI1_TX0N	10	HDMI1_CLK_P
11	GND	12	HDMI1_CLK_N
13	NC	14	NC
15	HDMI1_SCL	16	HDMI1_SDA
17	GND	18	HDMI1_P5V
19	HDMI1_HPD	H1	GND
H2	GND	H3	GND
H4	GND		

LAN Port

Connector type: RJ45 port with LEDs

Connector location: CON2

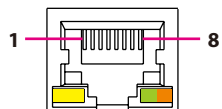

Pin	Definition	Pin	Definition
1	TCT	2	LAN2_MDI3N
3	LAN1_MDI3P	4	LAN1_MDI2N
5	LAN1_MDI2P	6	LAN1_MDI1N
7	LAN1_MDI1P	8	LAN1_MDI0N
9	LAN1_MDI0P	10	GND
11	LAN1_LED1P	12	LAN1_LED_ACT#
13	LAN1_LED2P	14	LAN1_LED3P
MH1	GND	MH2	GND

JAE-TX25

Connector location: CON1



Pin	Definition	Pin	Definition
1	DDP_3N	18	HDMI0_CLK_P
2	DDP_3P	19	GND
3	GND	20	HDMI0_TX0N
4	DDP_2N	21	HDMI0_TX0P
5	DDP_2P	22	GND
6	GND	23	HDMI0_TX1N
7	DDP_1N	24	HDMI0_TX1P
8	DDP_1P	25	GND
9	GND	26	HDMI0_TX2N
10	DDP_0N	27	HDMI0_TX2P
11	DDP_0P	28	GND
12	GND	29	HDMI0_SDA
13	DDP_AUXN	30	HDMI0_SCL
14	DDP_AUXP	31	HDMI0_HPD
15	DDP_HPD	32	GND
16	GND	33	VIN_M
17	HDMI0_CLK_N	34	VIN_M

Pin	Definition	Pin	Definition
35	VIN_M	58	USB_TX2P
36	VIN_M	59	GND
37	VIN_M	60	USB_DN2
38	VIN_M	61	USB_DP2
39	VIN_M	62	GND
40	VIN_M	63	USB_DN7
41	NC	64	USB_DP7
42	NC	65	GND
43	NC	66	USB_DN6
44	NC	67	USB_DP6
45	NC	68	GND
46	NC	69	SKPR_LOUT 44
47	NC	70	SKPR_ROUT 44
48	NC	71	HDMI0_CEC 40
49	NC	72	GND
50	SYS_FAN_EN# 46	73	PS_ON# 19
51	COM1_RXD 46	74	PWR_STATUS
52	COM1_TXD 46	75	GND
53	GND	76	GND
54	USB_RX2N	77	GND
55	USB_RX2P	78	GND
56	GND	79	GND
57	USB_TX2N	80	GND

Internal Connectors

Mini-PCIe Connector

Connector location: CN5

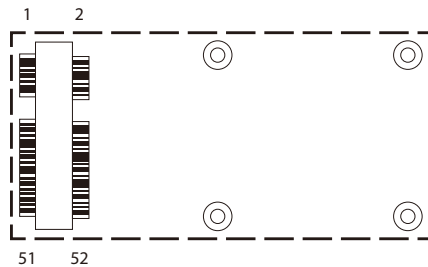

Pin	Definition	Pin	Definition
1	WAKE#	2	+V3.3A_MIN
3	NC	4	GND
5	NC	6	D15VS
7	CLKREQ#	8	NC
9	GND	10	NC
11	REFCLK-	12	NC
13	REFCLK+	14	NC
15	GND	16	NC
17	NC	18	GND
19	NC	20	DISABLE#
21	GND	22	PERST#
23	PERn0	24	+V3.3A_MIN
25	PERp0	26	GND

Pin	Definition	Pin	Definition
27	GND	28	D15VS
29	GND	30	SMB_CLK
31	PETn0	32	SMB_DATA
33	PETp0	34	GND
35	GND	36	USB_D-
37	NC	38	USB_D+
39	+V3.3A_MIN	40	GND
41	+V3.3A_MIN	42	LED_WWAN#
43	NC	44	LED_WLAN#
45	NC	46	LED_WPAN#
47	NC	48	D15VS
49	NC	50	GND
51	NC	52	+V3.3A_MIN

SATA Connector (7-pin and 15-pin)

Connector type: Standard Serial ATAII 7P and 15P

Connector location: SATA1

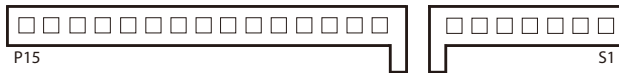

Pin	Definition	Pin	Definition
S1	GND	S2	SATA_TXPO_C
S3	SATA_TXNO_C	S4	GND
S5	SATA_RXNO_C	S6	SATA_RXNO_C
S7	GND	P1	NC
P2	NC	P3	NC
P4	GND	P5	GND
P6	GND	P7	+5V
P8	+5V	P9	+5V
P10	GND	P11	NC
P12	SATA_DET#	P13	NC
P14	NC	P15	NC
MH1	GND	MH2	GND

Battery Connector

Connector type: 1x2 2-pin header JST, 1.25mm pitch

Connector location: J1



Pin	Definition	Pin	Definition
1	GND	2	BAT
MH1	GND	MH2	GND

Debug Port

Connector type: 1x10 10-pin header JST, 1.0mm pitch

Connector location: J2



Pin	Definition	Pin	Definition
1	GND	2	P80_RST#
3	CLK_PCI_P80	4	LPC_FRAME#
5	LPC_AD3	6	LPC_AD2
7	LPC_AD1	8	LPC_ADO
9	3VSB	10	3VSB
MH1	GND	MH2	GND

FAN Connector

Connector type: 1x4 4-pin header, 2.54mm pitch

Connector location: FAN1



Pin	Definition	Pin	Definition
1	GND	2	+12V
3	FAN_TACT	4	FAN_CTRL

SIM Card Slot

Connector location: CN4

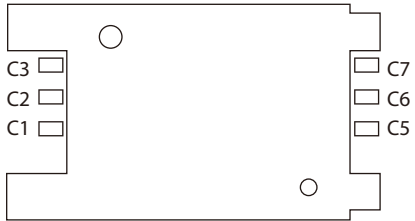

Pin	Definition	Pin	Definition
C1	SIM_VCC	C2	SIM_RST
C3	SIM_CLK	C5	GND
C6	SIM_VPP	C7	SIM_IO

Chapter 3: System Setup

Removing the Chassis Cover



Prior to removing the chassis cover, make sure the unit's power is off and disconnected from the power sources to prevent electric shock or system damage.

1. The screws on the back are used to secure the cover to the chassis. Remove these screws and put them in a safe place for later use.



Installing a SO-DIMM

NDiS M324 supports two channels of SO-DIMM. If you want to install a single memory module, please install to DIMM2 first.

Primary (DIMM2 at bottom of the chassis)

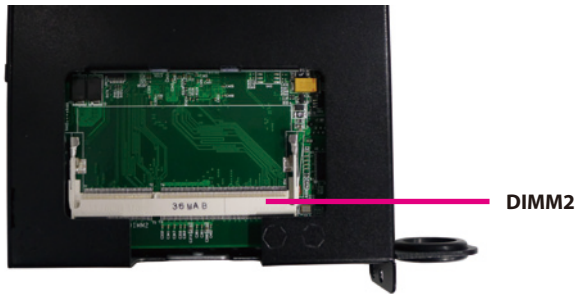

Secondary (DIMM1 at top of the chassis)



Installing to DIMM2 Slot (Primary)

1. At the bottom of the system, loosen the screw on the DIMM cover and remove it from the chassis.

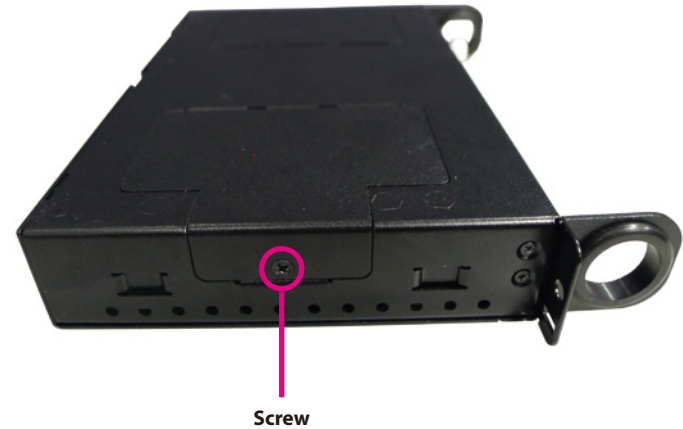

2. Push the ejector tabs which are at the ends of the socket outward. This indicates that the socket is unlocked.

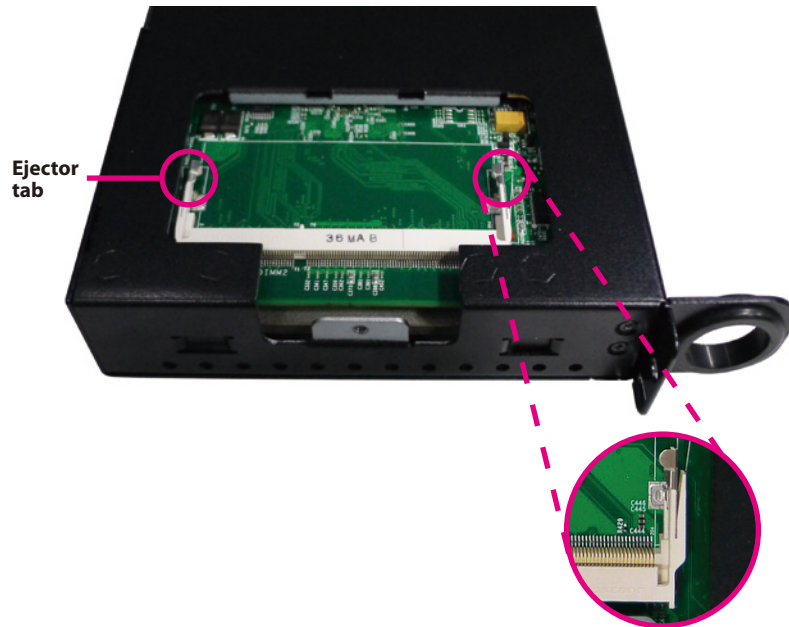

3. Note how the module is keyed to the socket. Grasping the module by its edges, align the module with the socket so that the “notch” on the module is aligned with the “key” on the socket. The key ensures the module can be plugged into the socket in only one direction.

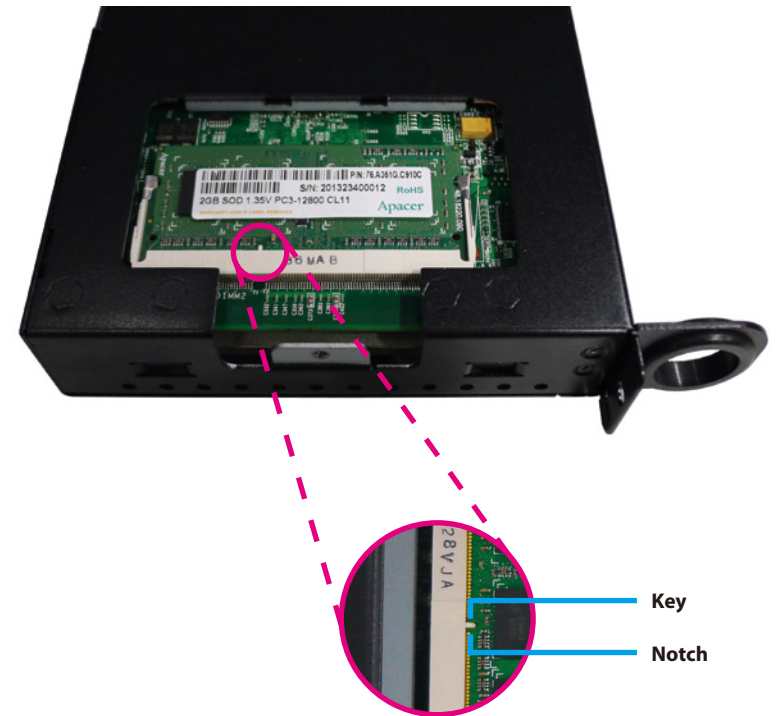

4. Insert the module into the socket at an approximately 30 degrees angle. Apply firm even pressure to each end of the module until it slips down into the socket. The contact fingers on the edge of the module will almost completely disappear inside the socket.

The ejector tabs at the ends of the socket will automatically snap into the locked position to hold the module in place.



Installing to DIMM1 Slot (Secondary)

1. Follow the instructions in the “Removing the Chassis Cover” section to remove the top cover.

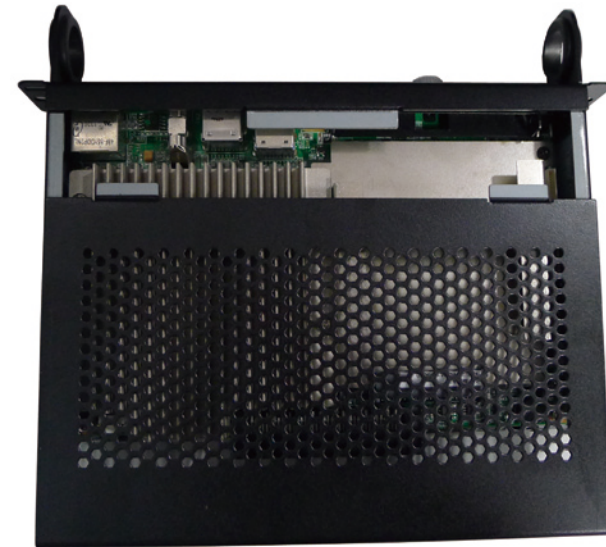

2. Loosen the 4 screws on the heat sink.

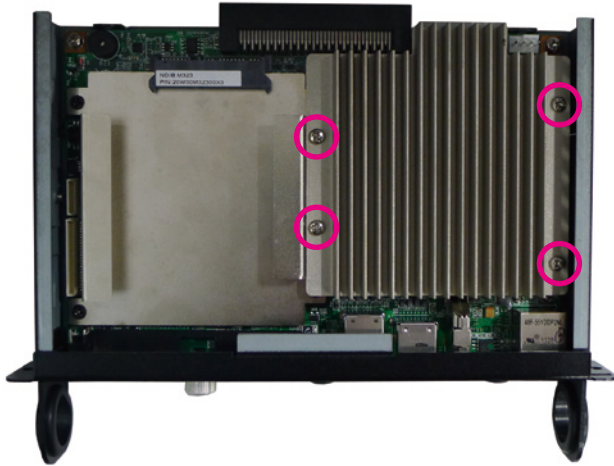

3. Remove the heatsink to access the DIMM slot.

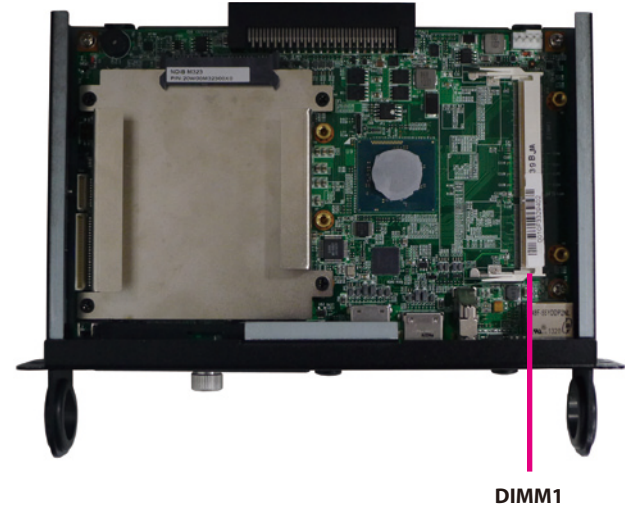

- Note how the module is keyed to the socket. Grasping the module by its edges, align the module with the socket so that the “notch” on the module is aligned with the “key” on the socket. The key ensures the module can be plugged into the socket in only one direction.

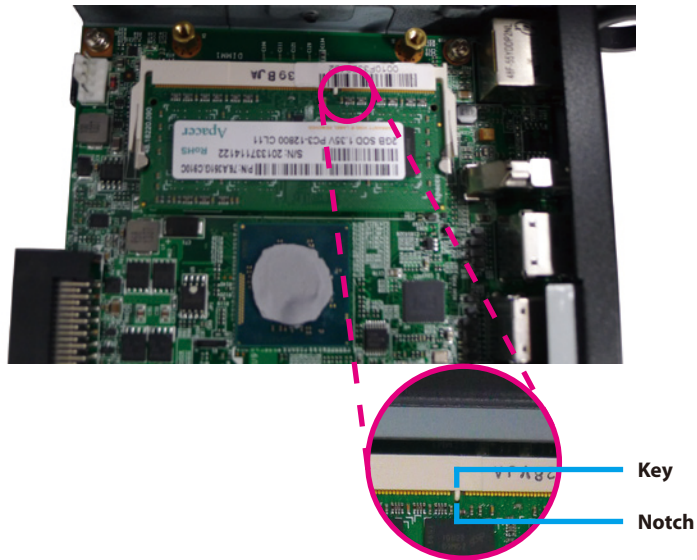

- Insert the module into the socket at an approximately 30 degrees angle. Apply firm even pressure to each end of the module until it slips down into the socket. The contact fingers on the edge of the module will almost completely disappear inside the socket.

The ejector tabs at the ends of the socket will automatically snap into the locked position to hold the module in place.

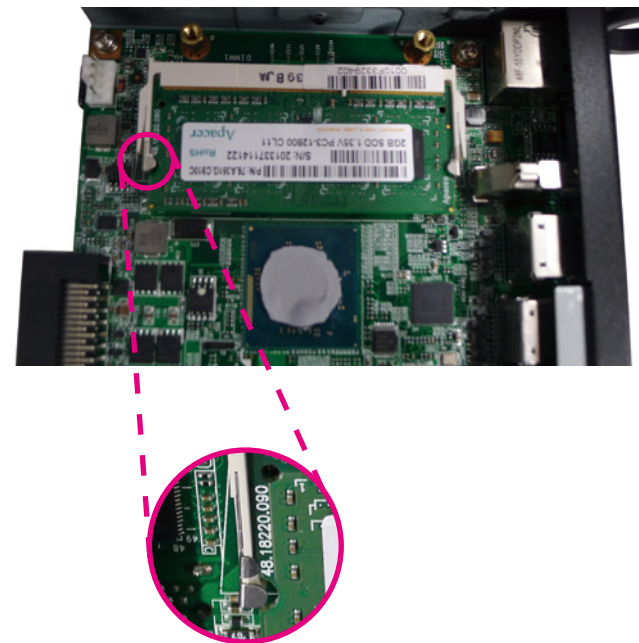

Installing a 2.5" HDD Storage

The system is equipped with a removable 2.5" HDD drive bay. To install a HDD, please follow the instructions below.



Please correctly follow the below instructions and noted items to avoid making unnecessary damages.

1. Remove the HDD cover located at the front panel by loosening the screw.

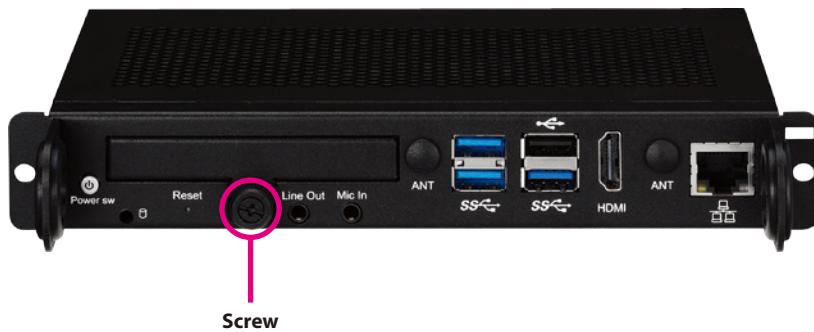

2. Gently take the cover out.



3. Align the mounting holes on the front of the HDD to the mounting holes on the cover, then tighten screws on both sides to secure it. Make sure the connector side of the HDD is facing outwards.

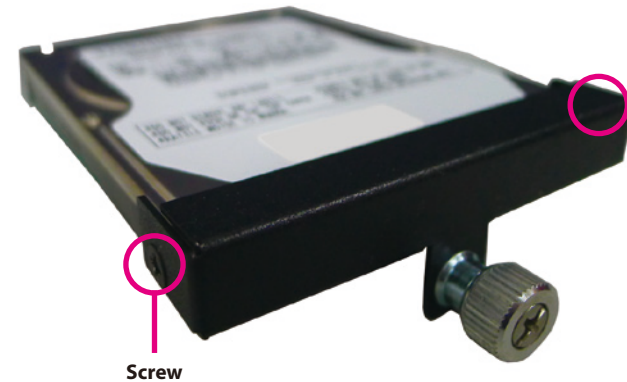

4. Put the HDD back into the slot gently, then tighten the screw to secure it.

Installing a Wireless LAN Module

1. At the bottom of the system, loosen the screw on the mini-PCI express and remove it from the chassis.
2. Locate the mini-PCI express slot on the board and insert the Wi-Fi module into the slot.

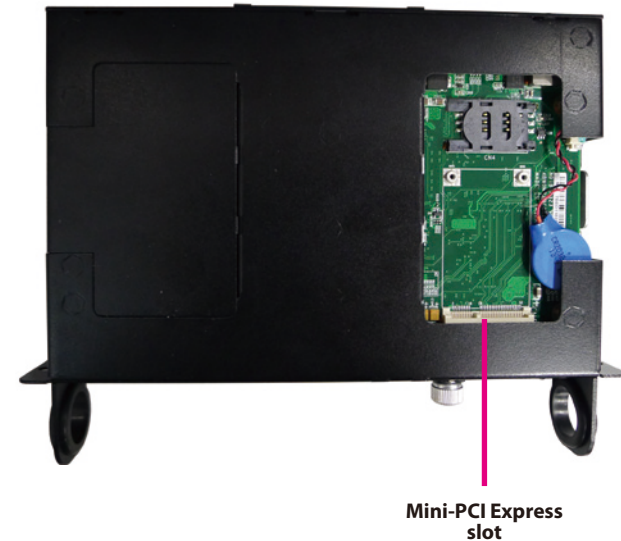
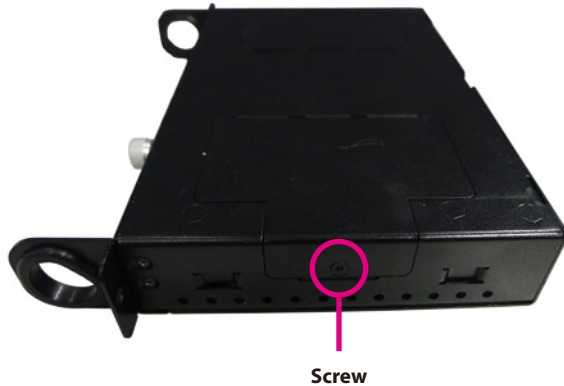

3. With the module fully inserted, tighten screws into the module's mounting holes to secure it.



Screw

4. Attach the RF cables onto the Wi-Fi module and wire the cables to the top side of the mainboard.



RF Cable

5. Insert the 2 rings (ring 1 then ring 2) into the Wi-Fi antenna jacks.

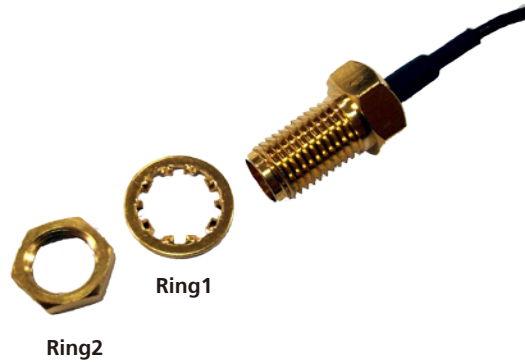

6. Turn to the top side of the mainboard and mount the Wi-Fi antenna jacks to the Wi-Fi antenna holes located at the front panel of the chassis then tighten the rings.



7. Connect the external antennas to the Wi-Fi antenna jacks.



Installing a 3G Module

1. Insert the 3G module in the same way as the instructions in the “Installing a Wireless LAN Module” section.
2. Attach the RF cable onto the 3G module’s RF connector and wire the cable to the top side of the mainboard.

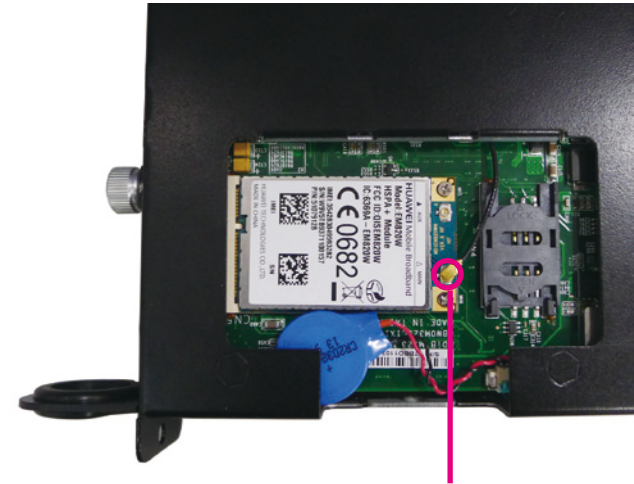

RF cable

3. Mount the 3G antenna jack to the 3G antenna hole located at the front panel of the chassis then tighten the ring.

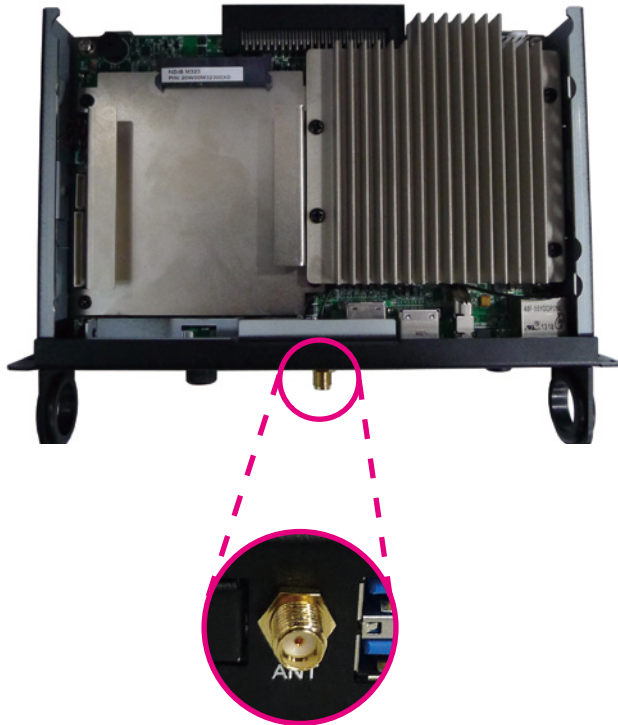

4. Connect an external antenna to the 3G antenna jack.

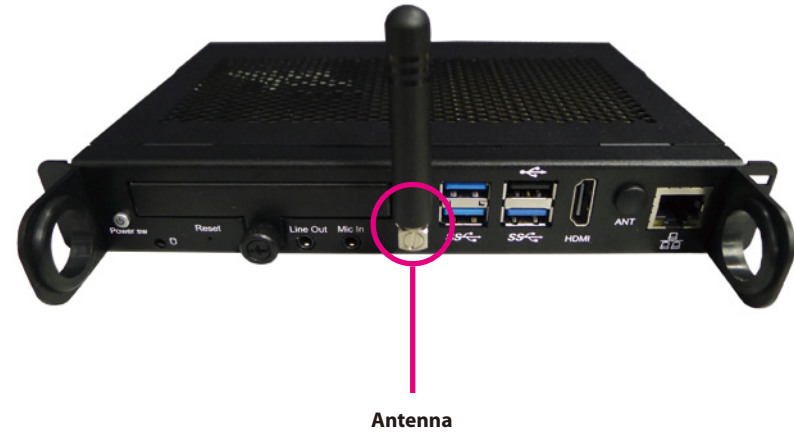

Chapter 4: BIOS Setup

This chapter describes how to use the BIOS setup program for the NDiS M324. The BIOS screens provided in this chapter are for reference only and may change if the BIOS is updated in the future.

To check for the latest updates and revisions, visit the NEXCOM Web site at www.nexcom.com.tw.

About BIOS Setup

The BIOS (Basic Input and Output System) Setup program is a menu driven utility that enables you to make changes to the system configuration and tailor your system to suit your individual work needs. It is a ROM-based configuration utility that displays the system's configuration status and provides you with a tool to set system parameters.

These parameters are stored in non-volatile battery-backed-up CMOS RAM that saves this information even when the power is turned off. When the system is turned back on, the system is configured with the values found in CMOS.

With easy-to-use pull down menus, you can configure such items as:

- Hard drives, diskette drives, and peripherals
- Video display type and display options
- Password protection from unauthorized use
- Power management features

The settings made in the setup program affect how the computer performs. It is important, therefore, first to try to understand all the setup options, and second, to make settings appropriate for the way you use the computer.

When to Configure the BIOS

- This program should be executed under the following conditions:
 - When changing the system configuration
 - When a configuration error is detected by the system and you are prompted to make changes to the setup program
 - When resetting the system clock
 - When redefining the communication ports to prevent any conflicts
 - When making changes to the Power Management configuration
 - When changing the password or making other changes to the security setup

Normally, CMOS setup is needed when the system hardware is not consistent with the information contained in the CMOS RAM, whenever the CMOS RAM has lost power, or the system features need to be changed.

Default Configuration

Most of the configuration settings are either predefined according to the Load Optimal Defaults settings which are stored in the BIOS or are automatically detected and configured without requiring any actions. There are a few settings that you may need to change depending on your system configuration.

Entering Setup











When the system is powered on, the BIOS will enter the Power-On Self Test (POST) routines. These routines perform various diagnostic checks; if an error is encountered, the error will be reported in one of two different ways:

- If the error occurs before the display device is initialized, a series of beeps will be transmitted.
- If the error occurs after the display device is initialized, the screen will display the error message.

Powering on the computer and immediately pressing allows you to enter Setup.

Press the  key to enter Setup:

Legends

Key	Function
	Moves the highlight left or right to select a menu.
	Moves the highlight up or down between sub-menus or fields.
	Exits the BIOS Setup Utility.
	Scrolls forward through the values or options of the highlighted field.
	Scrolls backward through the values or options of the highlighted field.
	Selects a field.
	Displays General Help.
	Load previous values.
	Load optimized default values.
	Saves and exits the Setup program.
	Press <Enter> to enter the highlighted sub-menu

Scroll Bar

When a scroll bar appears to the right of the setup screen, it indicates that there are more available fields not shown on the screen. Use the up and down arrow keys to scroll through all the available fields.

Submenu

When “▶” appears on the left of a particular field, it indicates that a submenu which contains additional options are available for that field. To display the submenu, move the highlight to that field and press  .

BIOS Setup Utility

Once you enter the AMI BIOS Setup Utility, the Main Menu will appear on the screen. The main menu allows you to select from several setup functions and one exit. Use arrow keys to select among the items and press  to accept or enter the submenu.

Main

The Main menu is the first screen that you will see when you enter the BIOS Setup Utility.

System Date

The date format is <day>, <month>, <date>, <year>. Day displays a day, from Monday to Sunday. Month displays the month, from January to December. Date displays the date, from 1 to 31. Year displays the year, from 1999 to 2099.

System Time

The time format is <hour>, <minute>, <second>. The time is based on the 24-hour military-time clock. For example, 1 p.m. is 13:00:00. Hour displays hours from 00 to 23. Minute displays minutes from 00 to 59. Second displays seconds from 00 to 59.

Aptio Setup Utility - Copyright (C) 2013 American Megatrends, Inc.				
Main	Advanced	Security	Boot	Save & Exit
BIOS Information				Set the Time. Use Tab to switch between Time elements.
Production Name	NDiSM324			
BIOS Vendor	American Megatrends			
BIOS Version	D323M086 x64			
Build Date and Time	07/02/2014 13:35:50			
CPU Configuration				
Intel(R) Celeron(R) CPU J1900 @ 1.99GHz				
CPU Signature	30673			
Memory Information				
Total Memory	8192 MB (LPDDR3)			
GOP Information				
Intel(R) GOP Driver	[7.1.1005]			
TXE Information				←→: Select Screen
Sec RC Version	00.05.00.00			↑↓: Select Item
TXE FW Version	01.00.02.1060			Enter: Select
EC Version		M323-R07		+/-: Change Opt.
PCB Version		C		F1: General Help
System Date		[Thu 07/31/2014]		F2: Previous Values
System Time		[11:55:58]		F3: Optimized Defaults
				F4: Save & Exit
				ESC: Exit
Version 2.16.1242. Copyright (C) 2013 American Megatrends, Inc.				

Advanced

The Advanced menu allows you to configure your system for basic operation. Some entries are defaults required by the system board, while others, if enabled, will improve the performance of your system or let you set some features according to your preference.



Setting incorrect field values may cause the system to malfunction.

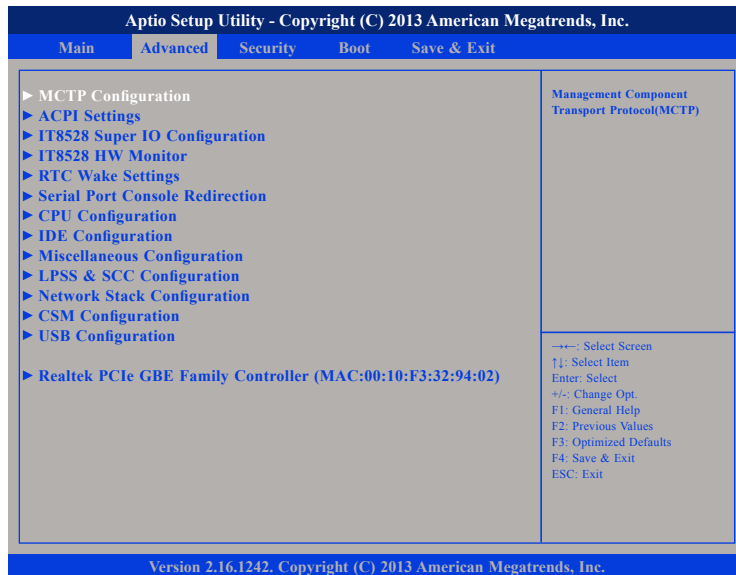

MCTP Support

This section is used to configure MCTP settings.

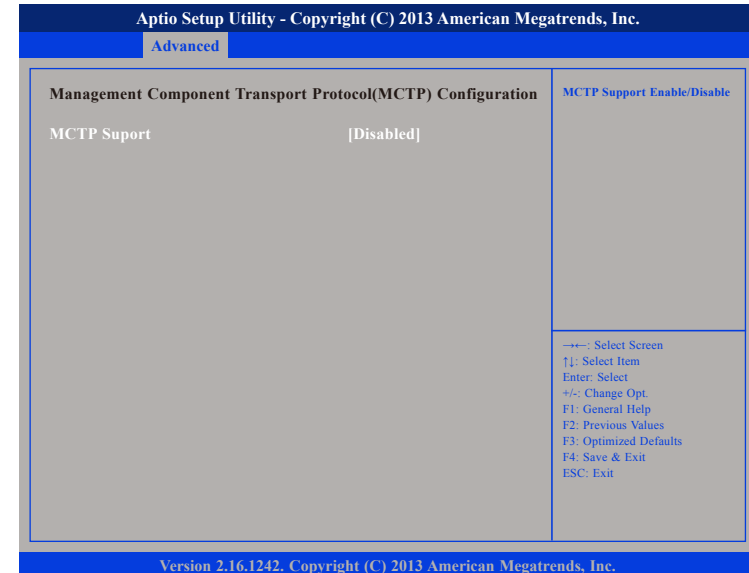

MCTP Support

Enables or disables MCTP support.

ACPI Settings

This section is used to configure ACPI Settings.



Enable Hibernation

Enables or disables system ability to hibernate (OS/S4 Sleep State). This option may not be effective with some OS.

ACPI Sleep State

Select the highest ACPI sleep state the system will enter when the suspend button is pressed. The options are Suspend Disabled and S3 (Suspend to RAM).

Lock Legacy Resources

Enables or disables lock of legacy resources.

IT8528 Super IO Configuration

This section is used to configure serial port 2.

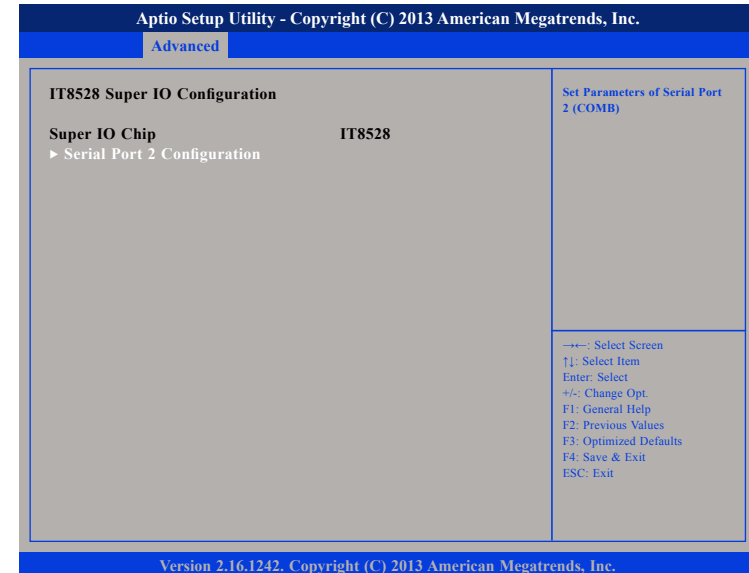

Super IO Chip

Displays the Super I/O chip used on the board.

Serial Port 2 Configuration



Device Settings

Displays the IO address and IRQ of serial port 2.

IT8528 HW Monitor

This section is used to monitor hardware status such as temperature, fan speed and voltages.

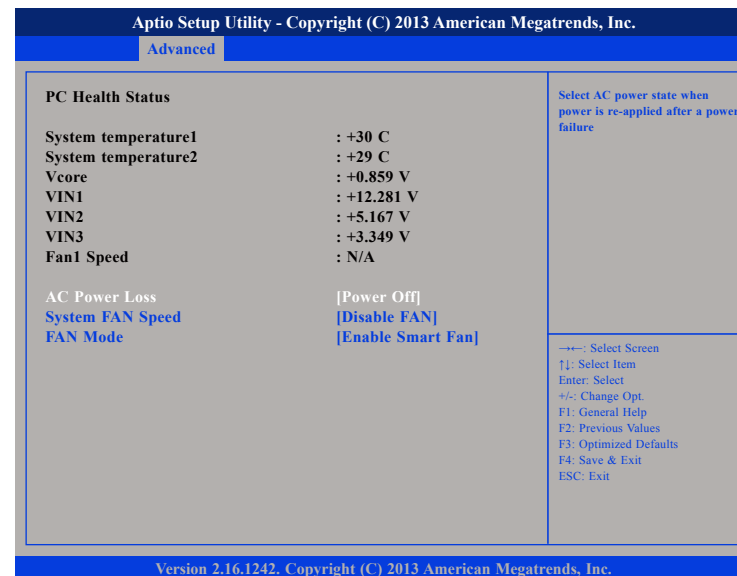

AC Power Loss

Power Off When power returns after an AC power failure, the system's power is off. You must press the power button to power-on the system.

Power On When power returns after an AC power failure, the system will automatically power-on.

System FAN Speed

Enables or disables fan speed control of the system.

FAN Mode

Configures the fan mode. The options are Disable Fan, Enable Smart Fan, Programming Fan and Always Full Speed.

RTC Wake Settings

This section is used to configure RTC Wake settings.

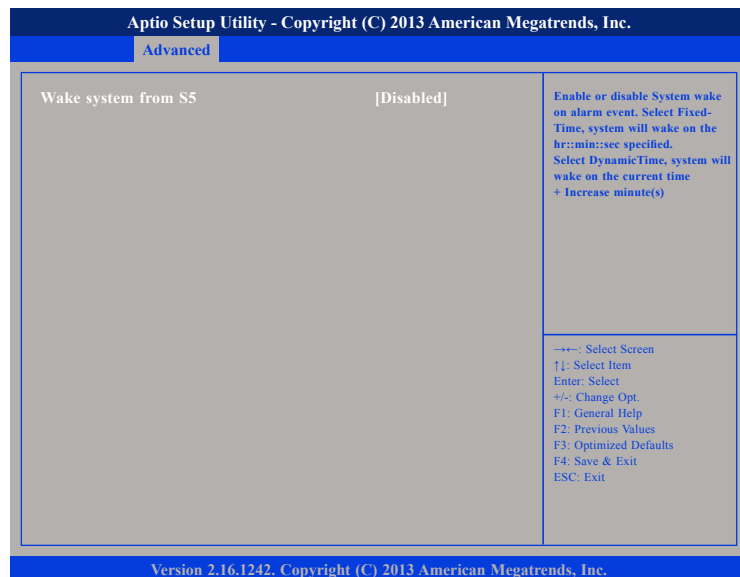

Wake System from S5

Enables or disables system wake on alarm event. When enabled, system will wake on the hr::min::sec specified.

Serial Port Console Redirection

This section is used to configure serial port console redirection settings.

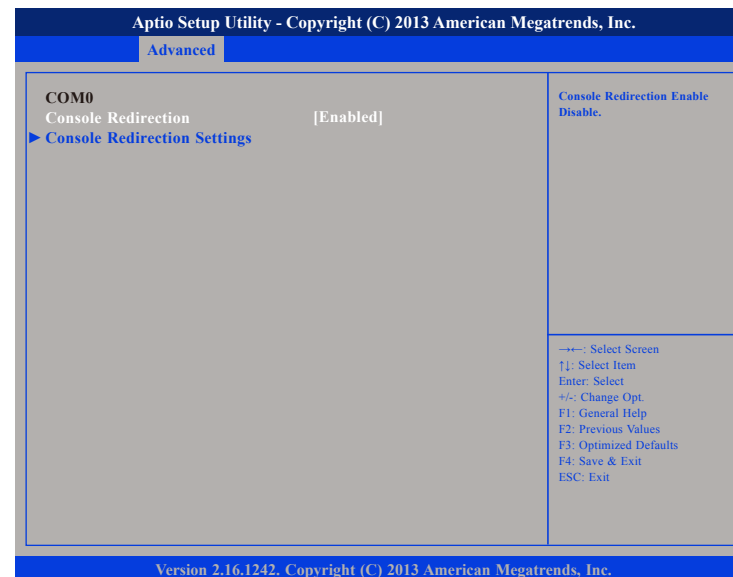

Console Redirection

Enables or disables the console redirection.

Console Redirection Settings

Specifies how the host computer and the remote computer (which the user is using) will exchange data. Both computers should have the same or compatible settings.

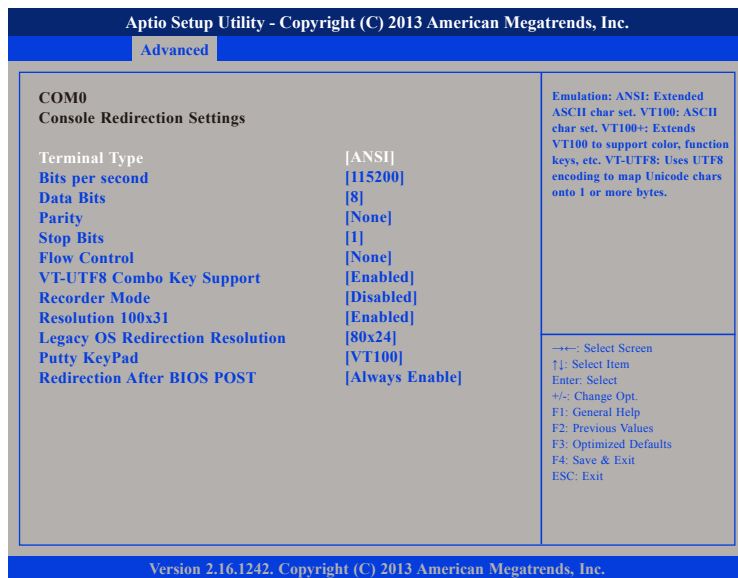

Console Redirection

Enables or disables the console redirection.

Terminal Type

ANSI Extended ASCII character set.

VT100 ASCII character set.

VT100+ Extends VT100 to support color, function keys, etc.

VT-UTF8 Uses UTF8 encoding to map Unicode characters onto 1 or more bytes.

Bits Per Second

Selects the serial port transmission speed. The speed must match the other side. Long or noisy lines may require a lower speed.

Data Bits

The options are 7 and 8.

Parity

A parity bit can be sent with the data bits to detect some transmission errors.

Even Parity bit is 0 if the number of 1's in the data bits is even.

Odd Parity bit is 0 if number of 1's in the data bits is odd.

Stop Bits

Stop bits indicate the end of a serial data packet. (A start bit indicates the beginning). The standard setting is 1 stop bit. Communication with slow devices may require more than 1 stop bit.

Flow Control

Flow control can prevent data loss from buffer overflow. When sending data and the receiving buffers are full, a "stop" signal can be sent to stop the data flow.

VT-UTF8 Combo Key Support

Enables or disables VT-UTF8 combination key support for ANSI/VT100 terminals.

Recorder Mode

When this field is enabled, only text will be sent. This is to capture the terminal data.

Resolution 100x31

Enables or disables extended terminal resolution.

Legacy OS Redirection

Selects the number of rows and columns that support redirection.

Putty KeyPad

Select Function Key and KeyPad on Putty

Redirection After BIOS POST

The settings specify if BootLoader is selected, then Legacy console redirection is disabled before booting to Legacy OS. Default value is Always Enable which means Legacy Console Redirection is enabled for Legacy OS.

CPU Configuration

This section is used to configure the CPU.



Limit CPUID Maximum

The CPUID instruction of some newer CPUs will return a value greater than 3. The default is Disabled because this problem does not exist in the Windows series operating systems. If you are using an operating system other than Windows, this problem may occur. If you are using an operating system other than Windows, this problem may occur

Execute Disable Bit

When this field is set to Disabled, it will force the XD feature flag to always return to 0.

Hardware Prefetcher

Turns on or off the mid level cache (L2) streamer prefetcher.

Adjacent Cache Line Prefetch

Turns on or off prefetching of adjacent cache lines.

Intel® Virtualization Technology

When this field is set to Enabled, the VMM can utilize the additional hardware capabilities provided by Vanderpool Technology.

Socket 0 CPU Information

This section displays the information of the CPU installed in Socket 0.

Aptio Setup Utility - Copyright (C) 2013 American Megatrends, Inc.

Advanced

Socket 0 CPU Information	Socket specific CPU Information
Intel(R) Celeron(R) CPU J1900 @ 1.99GHz	
CPU Signature	30673
Microcode Patch	320
Max CPU Speed	1990 MHz
Min CPU Speed	1334 MHz
Processor Cores	4
Intel HT Technology	Not Supported
Intel VT-x Technology	Supported
L1 Data Cache	24 kB x 4
L1 Code Cache	32 kB x 4
L2 Cache	1024 kB x 2
L3 Cache	Not Present

→←: Select Screen
↑↓: Select Item
Enter: Select
+/-: Change Opt.
F1: General Help
F2: Previous Values
F3: Optimized Defaults
F4: Save & Exit
ESC: Exit

Version 2.16.1242. Copyright (C) 2013 American Megatrends, Inc.

IDE Configuration

This section is used to configure the IDE drives.

Aptio Setup Utility - Copyright (C) 2013 American Megatrends, Inc.

Advanced

IDE Configuration	Select IDE / AHCI
SATA Mode	[AHCI Mode]
SATA Port0	
Not Present	

→←: Select Screen
↑↓: Select Item
Enter: Select
+/-: Change Opt.
F1: General Help
F2: Previous Values
F3: Optimized Defaults
F4: Save & Exit
ESC: Exit

Version 2.16.1242. Copyright (C) 2013 American Megatrends, Inc.

SATA Mode Selection

Configures the SATA as IDE or AHCI mode.

- IDE This option configures the Serial ATA drives as Parallel ATA physical storage device.
- AHCI This option configures the Serial ATA drives to use AHCI (Advanced Host Controller Interface). AHCI allows the storage driver to enable the advanced Serial ATA features which will increase storage performance.

Miscellaneous Configuration

This section is used to configure other miscellaneous settings.



OS Selection

Selects the operating system as Windows 7 or Windows 8.X.

LPSS & SCC Configuration

This section is used to configure LPSS and SCC settings.

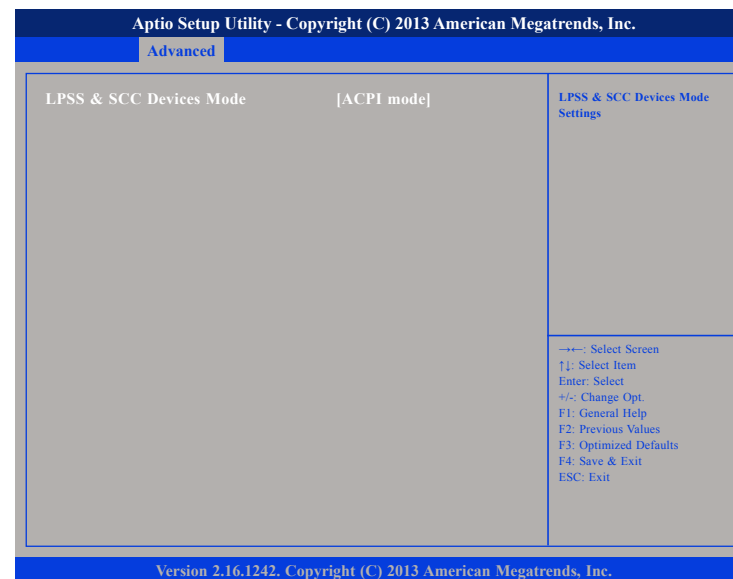

LPSS & SCC Devices Mode

Selects the LPSS and SCC device mode as ACPI mode or PCI mode.

Network Stack Configuration

This section is used to configure the network stack settings.

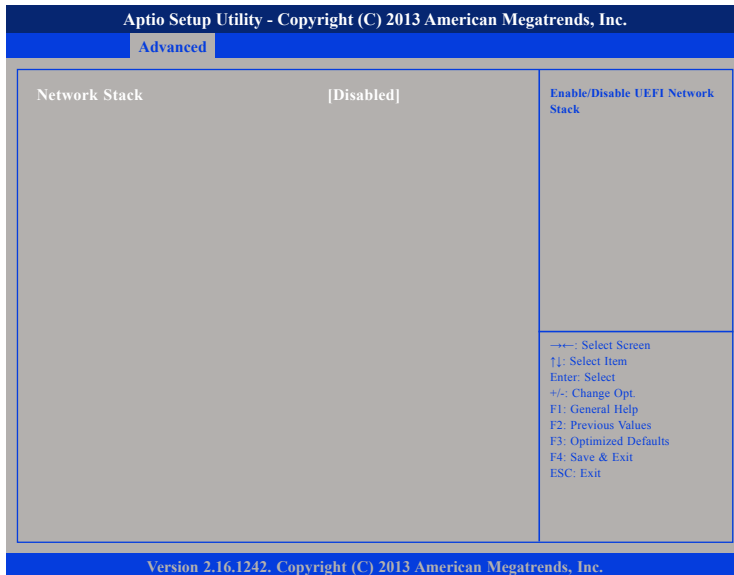

Network Stack

Enables or disables UEFI network stack.

CSM Configuration

This section is used to configure the compatibility support module features.

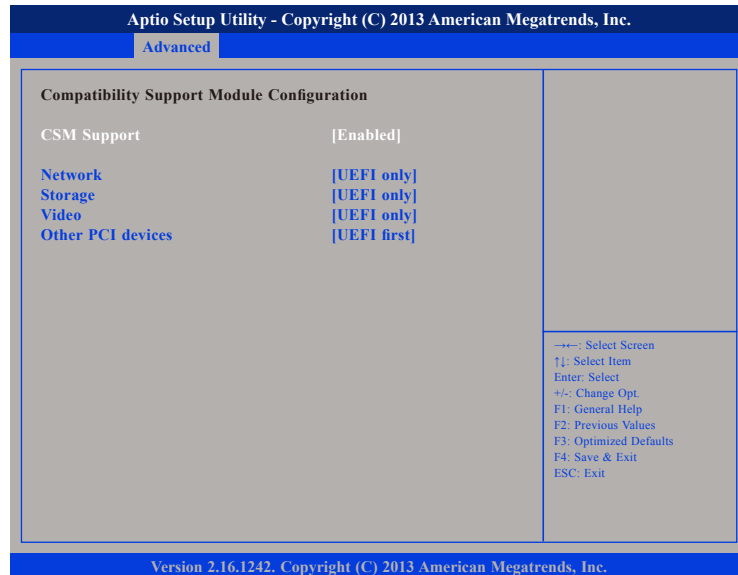

CSM Support

This field is used to enable or disable CSM support, if Auto option is selected, based on OS, CSM will be enabled or disabled automatically.

Network

Enables or disables the boot option for legacy network devices.

Storage

Enables or disables the boot option for legacy storage devices.

Video

Enables or disables the boot option for legacy video devices.

Other PCI Devices

Enables or disables the boot option for legacy PCI devices.



Before Windows 7 installation, please set Network, Storage, Video and Other PCI Devices settings to "Legacy only".

USB Configuration

This section is used to configure the USB.



EHCI Hand-off

This is a workaround for OSs that does not support EHCI hand-off. The EHCI ownership change should be claimed by the EHCI driver.

USB Mode

Configures the USB mode as XHCI Mode or EHCI mode.



Before Windows 7 installation, please set the USB mode as "EHCI mode".

Legacy USB Support

- Enabled Enables Legacy USB.
- Auto Disables support for Legacy when no USB devices are connected.
- Disabled Keeps USB devices available only for EFI applications.

XHCI Hand-off

This is a workaround for OSs that does not support XHCI hand-off. The XHCI ownership change should be claimed by the XHCI driver.

Realtek PCIe GbE Family Controller

Displays the driver information of the Ethernet controller.

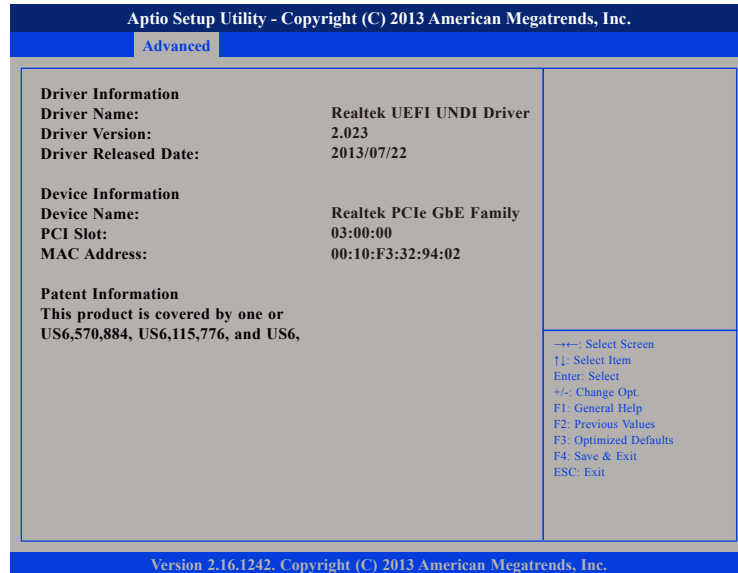

Legacy USB Support

- Enabled Enables Legacy USB.
- Auto Disables support for Legacy when no USB devices are connected.
- Disabled Keeps USB devices available only for EFI applications.

XHCI Hand-off

This is a workaround for OSs that does not support XHCI hand-off. The XHCI ownership change should be claimed by the XHCI driver.

Security

Aptio Setup Utility - Copyright (C) 2013 American Megatrends, Inc.

Main Advanced **Security** Boot Save & Exit

Password Description	Set Administrator Password
<p>If ONLY the Administrator's password is set, then this only limits access to Setup and is only asked for when entering Setup.</p> <p>If ONLY the User's password is set, then this is a power on password and must be entered to boot or enter Setup. In Setup the User will have Administrator rights.</p> <p>The password length must be in the following range:</p> <p>Minimum length 3</p> <p>Maximum length 20</p> <p>Administrator Password</p> <p>User Password</p>	<p>→←: Select Screen ↑↓: Select Item Enter: Select +/-: Change Opt. F1: General Help F2: Previous Values F3: Optimized Defaults F4: Save & Exit ESC: Exit</p>

Version 2.16.1242. Copyright (C) 2013 American Megatrends, Inc.

Administrator Password

Select this to reconfigure the administrator's password.

User Password

Select this to reconfigure the user's password.

Boot

This section is used to configure the boot features.

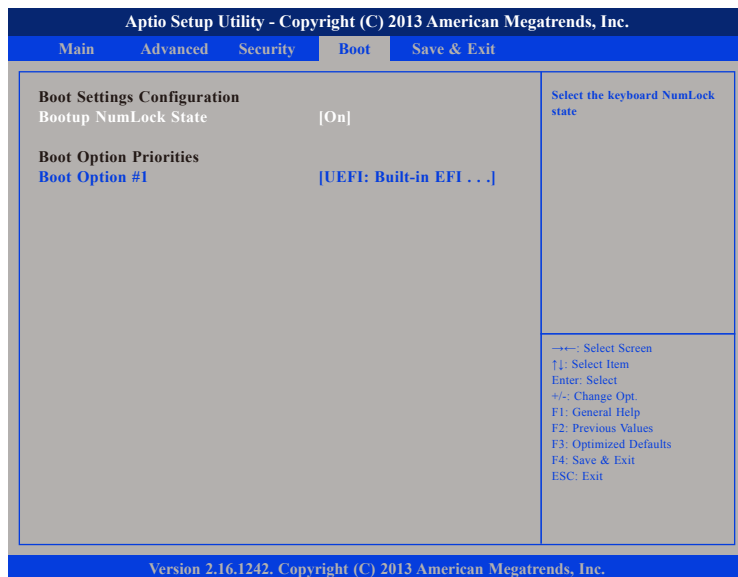

Bootup NumLock State

This allows you to determine the default state of the numeric keypad. By default, the system boots up with NumLock on wherein the function of the numeric keypad is the number keys. When set to Off, the function of the numeric keypad is the arrow keys.

Boot Option Priorities

Adjust the boot sequence of the system. Boot Option #1 is the first boot device that the system will boot from, next will be #2 and so forth.

Save & Exit

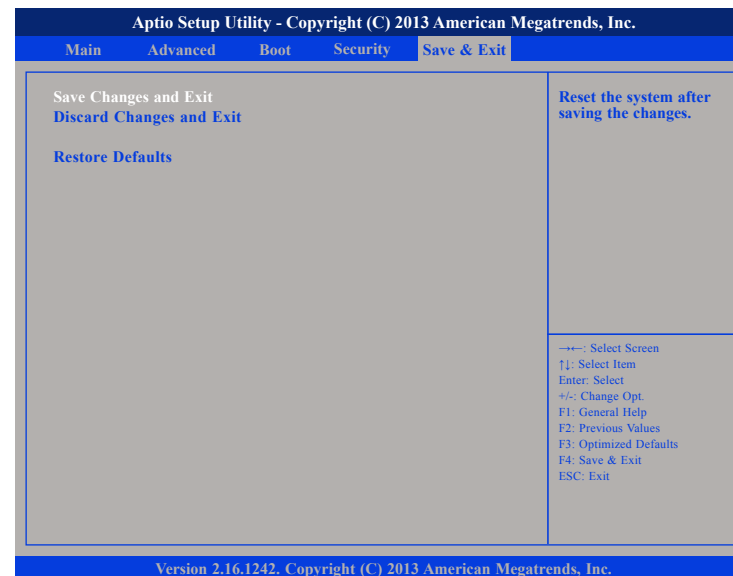

Save Changes and Exit

To save the changes and exit the Setup utility, select this field then press <Enter>. A dialog box will appear. Confirm by selecting Yes. You can also press <F4> to save and exit Setup.

Discard Changes and Exit

To exit the Setup utility without saving the changes, select this field then press <Enter>. You may be prompted to confirm again before exiting. You can also press <ESC> to exit without saving the changes.

Restore Defaults

To restore the BIOS to default settings, select this field then press <Enter>. A dialog box will appear. Confirm by selecting Yes.

Appendix A: Watchdog Timer

NDiS M324 features a watchdog timer that resets the CPU or generates an interrupt if the processor stops operating for any reason. This feature ensures system reliability in industrial standalone or unmanned environments.

Watchdog Timer Control Register

WDT_CONTROL BYTE	0x68	// 0x68
Bit 7: WDT enable	0: Disable WDT, 1: Enable WDT	
Bit 1: WDT output	0: WDT via EC reset, 1: WDT via KBRST	
Bit 0: WDT timeout value unit	0: Second, 1: Minute	
Default: 0x00		
WDT_TIMEOUT BYTE	0x69	// 0x69
Second: 3~255 sec		
Minute: 1~255 min		
Default: 3		

Appendix B: DASH Function (Remote Management)

NDiS M324 supports remote management (DASH).

Main Features

Remote system status monitor

- Device power status monitor

Remote power control

- Power on
- Power off
- Power reset

USB redirection

- Share local drive

Remote BIOS management

- Update BIOS
- Monitoring and Control

Discovery

- Scan DAHS supported computer

Role-base authentication

- Modify role
- Del role
- Assign privileges

Account management

- Add account
- Del account
- Assign role
- Modify password

Serial over LAN (text console redirection)

The software is provided in the driver CD and can also be downloaded from NEXCOM's website.

1. Standard DASH_SDK, Ver. 1.2.

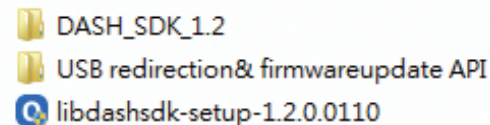

2. NEXCOM sample code and tool.

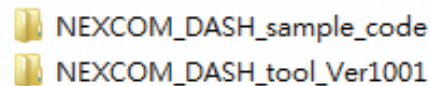

3. Realtek management console tool (free).

