



NEXCOM International Co., Ltd.

IoT Automation Solutions Business Group

Fan-less Computer

NISE 106

User Manual

CONTENTS

Preface

Copyright	iv
Disclaimer	iv
Acknowledgements	iv
Regulatory Compliance Statements	iv
Declaration of Conformity	iv
RoHS Compliance	v
Warranty and RMA	vi
Safety Information	viii
Installation Recommendations	viii
Safety Precautions	ix
Technical Support and Assistance	x
Conventions Used in this Manual	x
Global Service Contact Information	xi
Package Contents	xiii
Ordering Information	xiv

Chapter 1: Product Introduction

Overview	1
Key Features	1
Hardware Specifications	2
Knowing Your NISE 106	4
Front Panel	4
Rear Panel	5
Mechanical Dimensions	6

Chapter 2: Jumpers and Connectors

Before You Begin	7
Precautions	7
Jumper Settings	8
Locations of the Jumpers and Connectors for NISE 106	9
NISB 106	9
Jumpers and DIP Switches	10
AT/ATX Power Select	10
ATX or Reset ON/OFF	10
Clear CMOS	11
OS Type Selection	11
Connector Pin Definitions	12
External I/O Interfaces - Front Panel	12
Power Button	12
9V - 30V DC Power Input	12
USB 3.0 Ports (USB3/4) and LAN2	13
USB 3.0 Ports (USB1/2) and LAN1	14
HDMI	15
DVI-D Connector	15
LED Indicators	16
External I/O Interfaces - Rear Panel	17
CFast Slot	17
SIM Card Slot	17
COM 1 Port (RS232/422/485)	18
COM 2 Port (RS232/422/485)	18

COM 3 and COM 4 Ports (RS232)	19
DisplayPort.....	19
Remote SW/Remote S3 Connector	20
Internal Connectors.....	21
SATA Connector.....	21
SATA Power Connector	21
Fan Connector	22
GPS Connector	22
CMOS Battery Connector.....	23
Port 80 Connector	23
Flash BIOS	24
LED Pin Header	24
Reset Button Connector.....	25
GPIO Pin Header	25
Line-out Pin Header.....	26
Mic-in Pin Header.....	26
Line-in Pin Header	27
COM2 5V/12V/RI Pin Header.....	27
GSM Mini-PCIe Earout Pin Header.....	28
GSM Mini-PCIe Mic-in Pin Header	28
Mini-PCIe Connector (3G/Wi-Fi)	29

Chapter 3: System Setup

Removing the Chassis Cover	30
Installing a SO-DIMM Memory Module	32
Installing a Wireless LAN Module (Half-size)	33
Installing a Wireless LAN Module (Full-size)	35
Installing a SIM Card	37
Installing a SATA Hard Drive	38
Installing a CFast Card	40
Packing.....	41

Chapter 4: BIOS Setup

About BIOS Setup	43
When to Configure the BIOS.....	43
Default Configuration	44
Entering Setup	44
Legends	44
BIOS Setup Utility.....	46
Main	46
Advanced	47
Chipset.....	55
Security	59
Boot.....	59
Save & Exit	60

Appendix A: Power Consumption61

Appendix B: LED Programming Guide.....63

Appendix C: Watchdog Timer Setting64

Appendix D: GPI/O Programming Guide.....65

PREFACE

Copyright

This publication, including all photographs, illustrations and software, is protected under international copyright laws, with all rights reserved. No part of this manual may be reproduced, copied, translated or transmitted in any form or by any means without the prior written consent from NEXCOM International Co., Ltd.

Disclaimer

The information in this document is subject to change without prior notice and does not represent commitment from NEXCOM International Co., Ltd. However, users may update their knowledge of any product in use by constantly checking its manual posted on our website: <http://www.nexcom.com>. NEXCOM shall not be liable for direct, indirect, special, incidental, or consequential damages arising out of the use of any product, nor for any infringements upon the rights of third parties, which may result from such use. Any implied warranties of merchantability or fitness for any particular purpose is also disclaimed.

Acknowledgements

NISE 106 is a trademark of NEXCOM International Co., Ltd. All other product names mentioned herein are registered trademarks of their respective owners.

Regulatory Compliance Statements

This section provides the FCC compliance statement for Class A devices and describes how to keep the system CE compliant.

Declaration of Conformity

FCC

This equipment has been tested and verified to comply with the limits for a Class A digital device, pursuant to Part 15 of FCC Rules. These limits are designed to provide reasonable protection against harmful interference when the equipment is operated in a commercial environment. This equipment generates, uses, and can radiate radio frequency energy and, if not installed and used in accordance with the instructions, may cause harmful interference to radio communications. Operation of this equipment in a residential area (domestic environment) is likely to cause harmful interference, in which case the user will be required to correct the interference (take adequate measures) at their own expense.

CE

The product(s) described in this manual complies with all applicable European Union (CE) directives if it has a CE marking. For computer systems to remain CE compliant, only CE-compliant parts may be used. Maintaining CE compliance also requires proper cable and cabling techniques.

RoHS Compliance



NEXCOM RoHS Environmental Policy and Status Update

NEXCOM is a global citizen for building the digital infrastructure. We are committed to providing green products and services, which are compliant with European Union RoHS (Restriction on Use of Hazardous Substance in Electronic Equipment) directive 2011/65/EU, to be your trusted green partner and to protect our environment.

RoHS restricts the use of Lead (Pb) < 0.1% or 1,000ppm, Mercury (Hg) < 0.1% or 1,000ppm, Cadmium (Cd) < 0.01% or 100ppm, Hexavalent Chromium (Cr6+) < 0.1% or 1,000ppm, Polybrominated biphenyls (PBB) < 0.1% or 1,000ppm, and Polybrominated diphenyl Ethers (PBDE) < 0.1% or 1,000ppm.

In order to meet the RoHS compliant directives, NEXCOM has established an engineering and manufacturing task force to implement the introduction of green products. The task force will ensure that we follow the standard NEXCOM development procedure and that all the new RoHS components and new manufacturing processes maintain the highest industry quality levels for which NEXCOM are renowned.

The model selection criteria will be based on market demand. Vendors and suppliers will ensure that all designed components will be RoHS compliant.

How to recognize NEXCOM RoHS Products?

For existing products where there are non-RoHS and RoHS versions, the suffix "(LF)" will be added to the compliant product name.

All new product models launched after January 2013 will be RoHS compliant. They will use the usual NEXCOM naming convention.

Warranty and RMA

NEXCOM Warranty Period

NEXCOM manufactures products that are new or equivalent to new in accordance with industry standard. NEXCOM warrants that products will be free from defect in material and workmanship for 2 years, beginning on the date of invoice by NEXCOM. HCP series products (Blade Server) which are manufactured by NEXCOM are covered by a three year warranty period.

NEXCOM Return Merchandise Authorization (RMA)

- Customers shall enclose the “NEXCOM RMA Service Form” with the returned packages.
- Customers must collect all the information about the problems encountered and note anything abnormal or, print out any on-screen messages, and describe the problems on the “NEXCOM RMA Service Form” for the RMA number apply process.
- Customers can send back the faulty products with or without accessories (manuals, cable, etc.) and any components from the card, such as CPU and RAM. If the components were suspected as part of the problems, please note clearly which components are included. Otherwise, NEXCOM is not responsible for the devices/parts.
- Customers are responsible for the safe packaging of defective products, making sure it is durable enough to be resistant against further damage and deterioration during transportation. In case of damages occurred during transportation, the repair is treated as “Out of Warranty.”
- Any products returned by NEXCOM to other locations besides the customers’ site will bear an extra charge and will be billed to the customer.

Repair Service Charges for Out-of-Warranty Products

NEXCOM will charge for out-of-warranty products in two categories, one is basic diagnostic fee and another is component (product) fee.

Repair Service Charges for Out-of-Warranty Products

NEXCOM will charge for out-of-warranty products in two categories, one is basic diagnostic fee and another is component (product) fee.

System Level

- Component fee: NEXCOM will only charge for main components such as SMD chip, BGA chip, etc. Passive components will be repaired for free, ex: resistor, capacitor.
- Items will be replaced with NEXCOM products if the original one cannot be repaired. Ex: motherboard, power supply, etc.
- Replace with 3rd party products if needed.
- If RMA goods can not be repaired, NEXCOM will return it to the customer without any charge.

Board Level

- Component fee: NEXCOM will only charge for main components, such as SMD chip, BGA chip, etc. Passive components will be repaired for free, ex: resistors, capacitors.
- If RMA goods can not be repaired, NEXCOM will return it to the customer without any charge.

Warnings

Read and adhere to all warnings, cautions, and notices in this guide and the documentation supplied with the chassis, power supply, and accessory modules. If the instructions for the chassis and power supply are inconsistent with these instructions or the instructions for accessory modules, contact the supplier to find out how you can ensure that your computer meets safety and regulatory requirements.

Cautions

Electrostatic discharge (ESD) can damage system components. Do the described procedures only at an ESD workstation. If no such station is available, you can provide some ESD protection by wearing an antistatic wrist strap and attaching it to a metal part of the computer chassis.

Safety Information

Before installing and using the device, note the following precautions:

- Read all instructions carefully.
- Do not place the unit on an unstable surface, cart, or stand.
- Follow all warnings and cautions in this manual.
- When replacing parts, ensure that your service technician uses parts specified by the manufacturer.
- Avoid using the system near water, in direct sunlight, or near a heating device.
- The load of the system unit does not solely rely for support from the rackmounts located on the sides. Firm support from the bottom is highly necessary in order to provide balance stability.
- The computer is provided with a battery-powered real-time clock circuit. There is a danger of explosion if battery is incorrectly replaced. Replace only with the same or equivalent type recommended by the manufacturer. Discard used batteries according to the manufacturer's instructions.



Danger of explosion if battery is incorrectly replaced. Replace with the same or equivalent type recommended by the manufacturer. Discard used batteries according to the manufacturer's instructions.

Installation Recommendations

Ensure you have a stable, clean working environment. Dust and dirt can get into components and cause a malfunction. Use containers to keep small components separated.

Adequate lighting and proper tools can prevent you from accidentally damaging the internal components. Most of the procedures that follow require only a few simple tools, including the following:

- A Philips screwdriver
- A flat-tipped screwdriver
- A grounding strap
- An anti-static pad

Using your fingers can disconnect most of the connections. It is recommended that you do not use needle-nose pliers to disconnect connections as these can damage the soft metal or plastic parts of the connectors.

Safety Precautions

1. Read these safety instructions carefully.
2. Keep this User Manual for later reference.
3. Disconnect this equipment from any AC outlet before cleaning. Use a damp cloth. Do not use liquid or spray detergents for cleaning.
4. For plug-in equipment, the power outlet socket must be located near the equipment and must be easily accessible.
5. Keep this equipment away from humidity.
6. Put this equipment on a stable surface during installation. Dropping it or letting it fall may cause damage.
7. The openings on the enclosure are for air convection to protect the equipment from overheating. **DO NOT COVER THE OPENINGS.**
8. Make sure the voltage of the power source is correct before connecting the equipment to the power outlet.
9. Place the power cord in a way so that people will not step on it. Do not place anything on top of the power cord. Use a power cord that has been approved for use with the product and that it matches the voltage and current marked on the product's electrical range label. The voltage and current rating of the cord must be greater than the voltage and current rating marked on the product.
10. All cautions and warnings on the equipment should be noted.
11. If the equipment is not used for a long time, disconnect it from the power source to avoid damage by transient overvoltage.
12. Never pour any liquid into an opening. This may cause fire or electrical shock.
13. Never open the equipment. For safety reasons, the equipment should be opened only by qualified service personnel.
14. If one of the following situations arises, get the equipment checked by service personnel:
 - a. The power cord or plug is damaged.
 - b. Liquid has penetrated into the equipment.
 - c. The equipment has been exposed to moisture.
 - d. The equipment does not work well, or you cannot get it to work according to the user's manual.
 - e. The equipment has been dropped and damaged.
 - f. The equipment has obvious signs of breakage.
15. Do not place heavy objects on the equipment.
16. The unit uses a three-wire ground cable which is equipped with a third pin to ground the unit and prevent electric shock. Do not defeat the purpose of this pin. If your outlet does not support this kind of plug, contact your electrician to replace your obsolete outlet.
17. **CAUTION: DANGER OF EXPLOSION IF BATTERY IS INCORRECTLY REPLACED. REPLACE ONLY WITH THE SAME OR EQUIVALENT TYPE RECOMMENDED BY THE MANUFACTURER. DISCARD USED BATTERIES ACCORDING TO THE MANUFACTURER'S INSTRUCTIONS.**

Technical Support and Assistance

1. For the most updated information of NEXCOM products, visit NEXCOM's website at www.nexcom.com.
2. For technical issues that require contacting our technical support team or sales representative, please have the following information ready before calling:
 - Product name and serial number
 - Detailed information of the peripheral devices
 - Detailed information of the installed software (operating system, version, application software, etc.)
 - A complete description of the problem
 - The exact wordings of the error messages

Warning!

1. Handling the unit: carry the unit with both hands and handle it with care.
2. Maintenance: to keep the unit clean, use only approved cleaning products or clean with a dry cloth.
3. CompactFlash: Turn off the unit's power before inserting or removing a CompactFlash storage card.

Conventions Used in this Manual



Warning:

Information about certain situations, which if not observed, can cause personal injury. This will prevent injury to yourself when performing a task.



Caution:

Information to avoid damaging components or losing data.



Note:

Provides additional information to complete a task easily.

Global Service Contact Information

Headquarters

NEXCOM International Co., Ltd.

9F, No. 920, Chung-Cheng Rd.,
ZhongHe District, New Taipei City, 23586,
Taiwan, R.O.C.

Tel: +886-2-8226-7786

Fax: +886-2-8226-7782

www.nexcom.com

America

USA

NEXCOM USA

2883 Bayview Drive,
Fremont CA 94538, USA

Tel: +1-510-656-2248

Fax: +1-510-656-2158

Email: sales@nexcom.com

www.nexcom.com

Asia

Taiwan

NEXCOM Intelligent Systems

Taipei Office

13F, No.920, Chung-Cheng Rd.,
ZhongHe District,
New Taipei City, 23586, Taiwan, R.O.C.

Tel: +886-2-8226-7796

Fax: +886-2-8226-7792

Email: sales@nexcom.com.tw

www.nexcom.com.tw

NEXCOM Intelligent Systems

Taichung Office

16F, No.250, Sec. 2, Chongde Rd.,
Beitun Dist.,

Taichung City 406, R.O.C.

Tel: +886-4-2249-1179

Fax: +886-4-2249-1172

Email: sales@nexcom.com.tw

www.nexcom.com.tw

Japan

NEXCOM Japan

9F, Tamachi Hara Bldg.,
4-11-5, Shiba Minato-ku,
Tokyo, 108-0014, Japan

Tel: +81-3-5419-7830

Fax: +81-3-5419-7832

Email: sales@nexcom-jp.com

www.nexcom-jp.com

China

NEXCOM China

1F & 2F, Block A, No. 16 Yonyou Software Park,
No. 68 Beiqing Road, Haidian District,
Beijing, 100094, China

Tel: +86-10-5704-2680

Fax: +86-10-5704-2681

Email: sales@nexcom.cn

www.nexcom.cn

NEXCOM Shanghai

Room 603/604, Huiyinmingzun Plaza Bldg., 1,
No.609, Yunlin East Rd.,
Shanghai, 200333, China
Tel: +86-21-5278-5868
Fax: +86-21-3251-6358
Email: sales@nexcom.cn
www.nexcom.cn

NEXCOM Surveillance Technology

Room202, Building B, the GuangMing
Industrial Zone Zhonghua Rd.,
Minzhi Street, Longhua District,
Shenzhen, 518000, China
Tel: +86-755-8364-7768
Fax: +86-755-8364-7738
Email: steveyang@nexcom.com.tw
www.nexcom.cn

NEXCOM United System Service

Hui Yin Ming Zun Building Room 1108,
Building No. 11, 599 Yunling Road, Putuo District,
Shanghai, 200062, China
Tel: +86-21-6125-8282
Fax: +86-21-6125-8281
Email: frankyang@nexcom.cn
www.nexcom.cn

Europe

United Kingdom NEXCOM EUROPE

10 Vincent Avenue,
Crownhill Business Centre,
Milton Keynes, Buckinghamshire
MK8 0AB, United Kingdom
Tel: +44-1908-267121
Fax: +44-1908-262042
Email: sales.uk@nexcom.eu
www.nexcom.eu

Italy

NEXCOM ITALIA S.r.l

Via Lanino 42,
21047 Saronno (VA), Italia
Tel: +39 02 9628 0333
Fax: +39 02 9625570
Email: nexcomitalia@nexcom.eu
www.nexcomitalia.it

Package Contents

Before continuing, verify that the NISE 106 package that you received is complete. Your package should have all the items listed in the following table.

Item	Part Number	Description	Qty
1	4NCPM00203X00	Terminal Blocks 2P Phoenix Contact:1803578	2
2	4NCPM00302X00	(T)Terminal Blocks 3P Phoenix Contact:1777992	1
3	50311F0144X00	I Head Screw Long Fei	2
4	50311F0326X00	Flat Head Screw Long Fei: F3x5 Nylok Ni+Heat Treatment	4
5	50311F0330X00	Round Head Screw Long Fei:P2x3 ISO+NYLON	2
6	6012200052X00	PE Zipper Bag #8	1
7	6012200053X00	PE Zipper Bag #3	1
8	60177A0438X00	(E)NISE 106 Quick Reference Guide VER:A SIZE:A4	1
9	602DCD0997X00	(N)NISE 106 DVD Driver VER:1.0	1

Ordering Information

The following information below provides ordering information for NISE 106.

NISE 106-N3160 (P/N: 10J00010603X0)

Intel® Celeron® Processor N3160 Quad Core, 1.6GHz fanless system

NISE 106-N3710 (P/N: 10J00010602X0)

Intel® Pentium® Processor N3710 Quad Core, 1.6GHz fanless system

- **24V, 60W AC/DC power adapter w/o power cord (P/N: 7400060033X00)**

CHAPTER 1: PRODUCT INTRODUCTION

Overview



Key Features

- Onboard Intel® Celeron® Processor N3160 Quad Core, 1.6GHz (NISE 106-N3160)
- Onboard Intel® Pentium® Processor N3710 Quad Core, 1.6GHz (NISE 106-N3710)
- 3x display output: 1x HDMI display + 1x DVI-D + 1x DP port
- 2x Intel® I210AT GbE LAN ports; Support WoL, Teaming and PXE
- 4x USB 3.0
- 2x DB9 for RS232/422/485, 2x DB9 for RS232
- 1x optional interface for optional Wi-Fi/3.5G/LTE modules
- Support -5°C~55°C extended operating temperature
- Support 9~30V DC input

Hardware Specifications

CPU Support

- Onboard Intel® Celeron® Quad Core Processor N3160, 2M Cache, 1.6GHz (NISE 106-N3160)
- Onboard Intel® Pentium® Quad Core Processor N3710, 2M Cache, 1.6GHz (NISE 106-N3710)

Main Memory

- 1x DDR3L SO-DIMM socket, supports DDR3L 1600/1333 4GB RAM max., un-buffered and non-ECC

Display Option

- 1x HDMI + 1x DVI-D + 1x DP DisplayPort

I/O Interface - Front

- ATX power on/off switch
- 1x Power status/1x HDD access/1x battery low/1x programming/4x Tx/Rx LEDs
- 2x Intel® I210AT GbE LAN ports; Support WoL, Teaming and PXE
- 1x HDMI + 1x DVI-D display output
- 4x USB 3.0 (900mA per each)
- 1x 3-pin DC input, supports +9 to 30VDC input

I/O Interface - Rear

- 1x DisplayPort
- 1x SIM Card holder
- 1x external CFast socket
- 2x DB9 for RS232/422/485 with auto flow control (COM1 and COM2)
- 2x DB9 for RS232 (COM3 and COM4)
- 2x Antenna holes for optional Wi-Fi/3.5G antenna

- 1x remote power on/off switch
- 1x optional I/F for optional Mini-PCIe Wi-Fi/3.5G/LTE/NEXCOM's automation module output

I/O Interface - Internal

- 4x GPI and 4x GPO (5V, TTL type)

Storage Device

- 1x 2.5" HDD (SATA3.0)

Expansion Slot

- 1x Mini-PCIe socket for optional Wi-Fi/4G LTE/3.5G modules

Power Requirement

- Power input: +9 to 30 Vdc
- 1x optional 24V, 60W power adapter

Dimensions

- 185mm (W) x 131mm (D) x 54mm (H) without wall-mount bracket

Construction

- Aluminum chassis with fanless design

Environment

- Operating Temperature:
Ambient with air flow: -5°C to 55°C
(according to IEC60068-2-1, IEC60068-2-2, IEC60068-2-14)
- Storage Temperature: -30°C to 85°C
- Relative Humidity: 10% to 95% (non-condensing)

- Shock protection:
 - HDD: 20G, half sine, 11ms, IEC60068-27
 - CFast: 50G, half sine, 11ms, IEC60068-27
- Vibration protection w/HDD condition:
 - Random: 0.5Grms @ 5~500 Hz, IEC60068-2-64
 - Sinusoidal: 0.5Grms @ 5~500 Hz, IEC60068-2-6
- Vibration protection w/CFast & SSD condition:
 - Random: 2Grms @ 5~500 Hz, IEC60068-2-64
 - Sinusoidal: 2Grms @ 5~500 Hz, IEC60068-2-6

Certifications

- CE
- FCC Class A

Support OS

- Windows 7, 32-bit and 64-bit
- Windows 8.1, 64-bit only
- Windows Embedded Standard 7, 32-bit and 64-bit
- Windows Embedded Standard 8, 64-bit only
- Windows 10 IoT Enterprise, 64-bit only

Knowing Your NISE 106

Front Panel

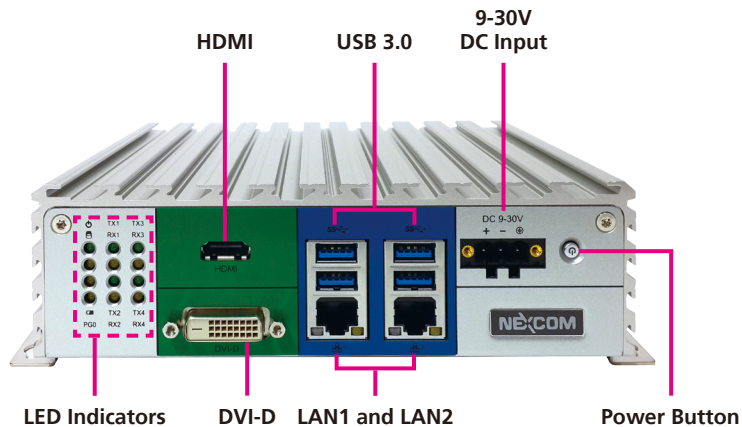

LED Indicators

Indicates the power status, hard drive, battery, GPIO (programmable) and COM1 to COM4 activity of the system.

HDMI

Used to connect a high-definition display.

USB 3.0

USB 3.0 ports to connect the system with USB 3.0/2.0 devices.

9-30V DC Input

Used to plug a DC power cord.

DVI-D

Used to connect a digital LCD panel.

LAN1 and LAN2 Ports

Used to connect the system to a local area network.

Power Button

Press to power-on or power-off the system.

Rear Panel

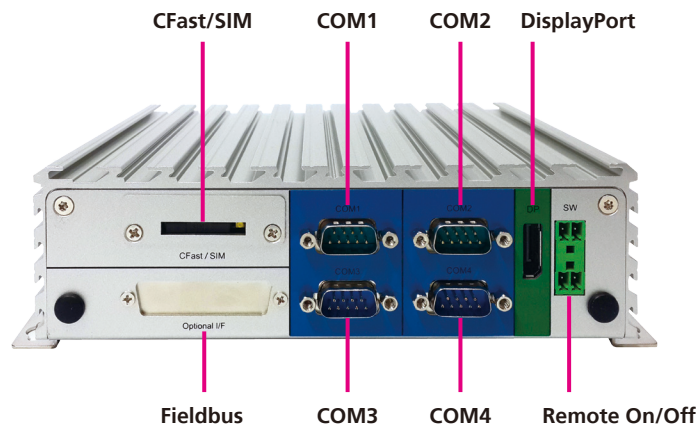

CFast/SIM

Used to insert a SIM card, CFast card can be installed with the cover removed.

COM1 to COM4

Four DB9 ports used to connect serial devices.

COM1 and COM2 support RS232/422/485 compatible devices.

COM3 and COM4 support RS232 compatible devices.

DisplayPort

DisplayPort to connect the system with display devices.

Fieldbus

Expansion slot for add-on fieldbus modules.

Remote On/Off

Used to connect a remote to power on/off the system.

Mechanical Dimensions

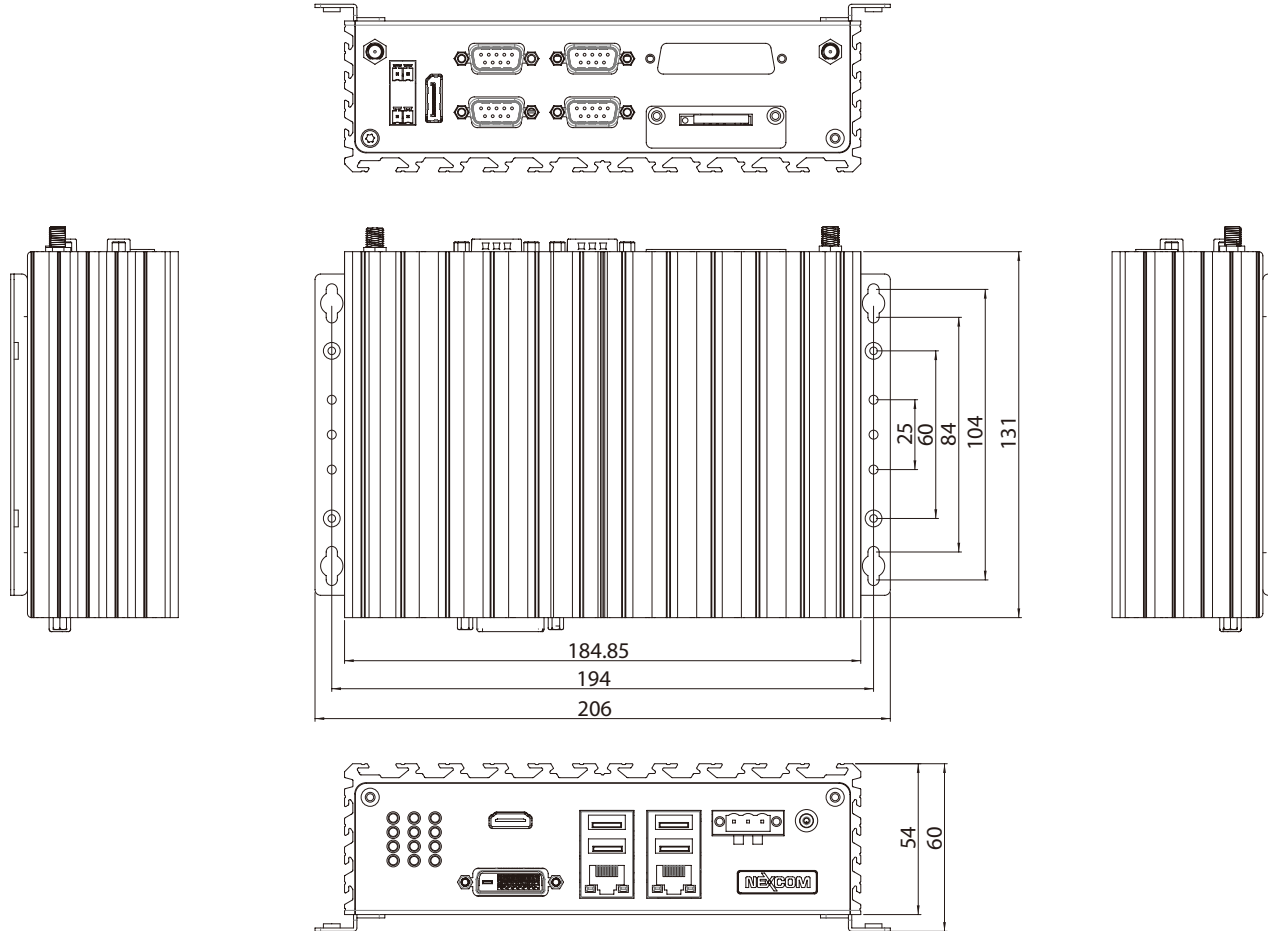

CHAPTER 2: JUMPERS AND CONNECTORS

This chapter describes how to set the jumpers and connectors on the NISE 106 motherboard.

Before You Begin

- Ensure you have a stable, clean working environment. Dust and dirt can get into components and cause a malfunction. Use containers to keep small components separated.
- Adequate lighting and proper tools can prevent you from accidentally damaging the internal components. Most of the procedures that follow require only a few simple tools, including the following:
 - A Philips screwdriver
 - A flat-tipped screwdriver
 - A set of jewelers screwdrivers
 - A grounding strap
 - An anti-static pad
- Using your fingers can disconnect most of the connections. It is recommended that you do not use needle-nosed pliers to disconnect connections as these can damage the soft metal or plastic parts of the connectors.
- Before working on internal components, make sure that the power is off. Ground yourself before touching any internal components, by touching a metal object. Static electricity can damage many of the electronic components. Humid environments tend to have less static electricity than

dry environments. A grounding strap is warranted whenever danger of static electricity exists.

Precautions

Computer components and electronic circuit boards can be damaged by discharges of static electricity. Working on computers that are still connected to a power supply can be extremely dangerous.

Follow the guidelines below to avoid damage to your computer or yourself:

- Always disconnect the unit from the power outlet whenever you are working inside the case.
- If possible, wear a grounded wrist strap when you are working inside the computer case. Alternatively, discharge any static electricity by touching the bare metal chassis of the unit case, or the bare metal body of any other grounded appliance.
- Hold electronic circuit boards by the edges only. Do not touch the components on the board unless it is necessary to do so. Don't flex or stress the circuit board.
- Leave all components inside the static-proof packaging that they shipped with until they are ready for installation.
- Use correct screws and do not over tighten screws.

Jumper Settings

A jumper is the simplest kind of electric switch. It consists of two metal pins and a cap. When setting the jumpers, ensure that the jumper caps are placed on the correct pins. When the jumper cap is placed on both pins, the jumper is short. If you remove the jumper cap, or place the jumper cap on just one pin, the jumper is open.

Refer to the illustrations below for examples of what the 2-pin and 3-pin jumpers look like when they are short (on) and open (off).

Two-Pin Jumpers: Open (Left) and Short (Right)

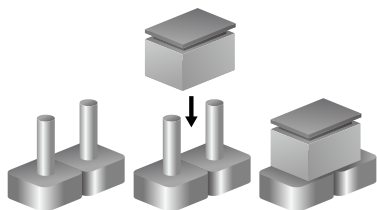

Three-Pin Jumpers: Pins 1 and 2 are Short

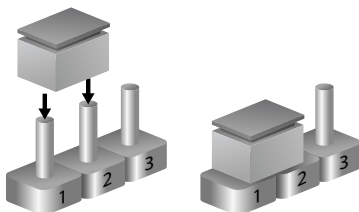

Locations of the Jumpers and Connectors for NISB 106

NISB 106

The figure below is the top view of the NISB 106 main board which is the main board used in NISE 106. It shows the locations of the jumpers and connectors.

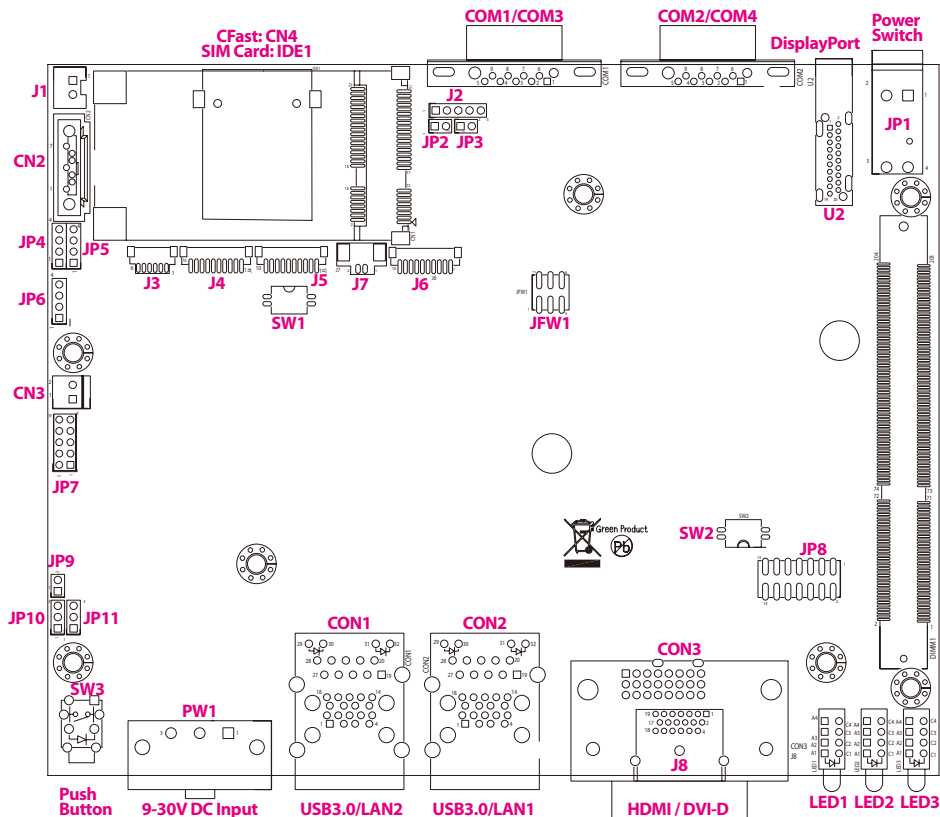

Jumpers and DIP Switches

AT/ATX Power Select

Connector type: 1x3 3-pin header, 2.00mm pitch
Connector location: JP11



Pin	Settings
1-2 On	AT Mode
2-3 On	ATX Mode

2-3 On: default

Pin	Definition
1	AT_PWRBT#
2	PMU_PWRBTN#
3	ATX_PWRBT#

ATX or Reset ON/OFF

Connector type: 1x3 3-pin header, 2.00mm pitch
Connector location: JP10



Pin	Settings
1-2 On	ATX Mode
2-3 On	AT Reset

1-2 On: default

Pin	Definition
1	PBT_TR
2	PBT_SW
3	PM_RESET#_J

Clear CMOS

Connector type: 2x2 DIP switch

Connector location: SW1

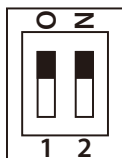

Pin	Settings
1-2 On	Normal
2-3 On	Clear BIOS Setting

1-2 On: default

Pin	Definition
1	GND
2	GND
3	SRTCST#
4	RTEST#

OS Type Selection

Connector type: 2x2 DIP switch

Connector location: SW2



Pin	Definition
1	GND
2	GND
3	OS_GPIO_SUS10
4	OS_GPIO_SUS11

Connector Pin Definitions

External I/O Interfaces - Front Panel

Power Button

Connector location: SW3



Pin	Definition	Pin	Definition
1	GND	2	PBT_SW
3	PBT_SW	4	GND
A1	PWR_SW_P	C1	PWR_SW_N
MH1	GND	MH2	GND

9V - 30V DC Power Input

Connector type: Phoenix Contact 1x3 3-pin terminal block

Connector location: PW1

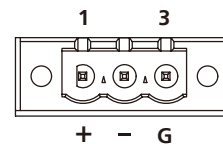

Pin	Definition
1	VIN_2
2	VIN_VSS
3	VIN_GND

USB 3.0 Ports (USB3/4) and LAN2

Connector type: RJ45 port with LEDs and dual USB 3.0 ports

Connector location: CON1A (USB) and CON1B (LAN2)

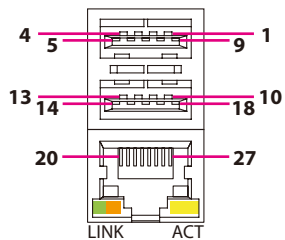

Act	Status
Flashing Yellow	Data activity
Off	No activity

Link	Status
Steady Green	1G network link
Steady Orange	100Mbps network link
Off	10Mbps or no link

USB

Pin	Definition	Pin	Definition
1	5VSB	2	USB_2N
3	USB_2P	4	GND
5	USB3_RXN2	6	USB3_RXP2
7	GND	8	USB3_TXN2
9	USB3_TXP2	10	5VSB
11	USB_3N	12	USB_3P
13	GND	14	USB3_RXN3
15	USB3_RXP3	16	GND
17	USB3_TXN3	18	USB3_TXP3

LAN2

Pin	Definition	Pin	Definition
19	V1P5_LAN2	20	LAN2_MDIOP
21	LAN2_MDION	22	LAN2_MDI1P
23	LAN2_MDI1N	24	LAN2_MDI2P
25	LAN2_MDI2N	26	LAN2_MDI3P
27	LAN2_MDI3N	28	GND
29	LAN2_LINK1G#	30	LAN2_LINK100#
31	LAN2_LED_ACT#	32	3VSB

USB 3.0 Ports (USB1/2) and LAN1

Connector type: RJ45 port with LEDs and dual USB 3.0 ports

Connector location: CON2A (USB) and CON2B (LAN1)

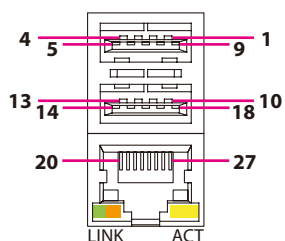

Act	Status
Flashing Yellow	Data activity
Off	No activity

Link	Status
Steady Green	1G network link
Steady Orange	100Mbps network link
Off	10Mbps or no link

USB

Pin	Definition	Pin	Definition
1	5VSB	2	USB_ON
3	USB_OP	4	GND
5	USB3_RXN0	6	USB3_RXP0
7	GND	8	USB3_TXN0
9	USB3_TXP0	10	5VSB
11	USB_1N	12	USB_1P
13	GND	14	USB3_RXN1
15	USB3_RXP1	16	GND
17	USB3_TXN1	18	USB3_TXP1

LAN1

Pin	Definition	Pin	Definition
19	V1P5_LAN	20	LAN1_MDI0P
21	LAN1_MDION	22	LAN1_MDI1P
23	LAN1_MDI1N	24	LAN1_MDI2P
25	LAN1_MDI2N	26	LAN1_MDI3P
27	LAN1_MDI3N	28	GND
29	LAN1_LINK1G#	30	LAN1_LINK100#
31	LAN1_LED_ACT#	32	3VSB

HDMI

Connector type: HDMI port

Connector location: J8

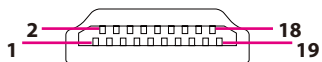

Pin	Definition	Pin	Definition
1	HDMI_TX2P_C	2	GND
3	HDMI_TX2N_C	4	HDMI_TX1P_C
5	GND	6	HDMI_TX1N_C
7	HDMI_TX0P_C	8	GND
9	HDMI_TX0N_C	10	HDMI_CLK_P_C
11	GND	12	HDMI_CLK_N_C
13	NC	14	NC
15	HDMI_CTRL_CLK	16	HDMI_CTRL_DAT
17	GND	18	VCC5
19	HDMI_HPD	MH1	FRONT_GND
MH2	FRONT_GND		

DVI-D Connector

Connector type: 24-pin D-Sub, 2.0mm-M-180 (DVI)

Connector location: CON3

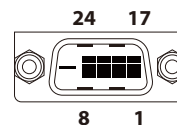

Pin	Definition	Pin	Definition
1	DVI_DATA2_N_C	2	DVI_DATA2_P_C
3	GND	4	NC
5	NC	6	DVI_CTRL_CLK
7	DVI_CTRL_DAT	8	NC
9	DVI_DATA1_N_C	10	DVI_DATA1_P_C
11	GND	12	NC
13	NC	14	VCC5
15	GND	16	DVI_HPD_C
17	DVI_DATA0_N_C	18	DVI_DATA0_P_C
19	GND	20	NC
21	NC	22	GND
23	DVI_CLK_P_C	24	DVI_CLK_N_C

LED Indicators

Connector location: LED1, LED2 and LED3

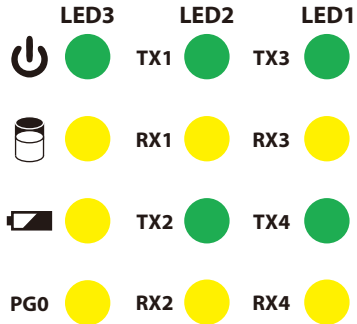

	Pin	Definition	Pin	Definition
LED1	A1	VCC5	C1	COM3_TXLEDN
	A2	VCC5	C2	COM3_RXLEDN
	A3	VCC5	C3	COM4_TXLEDN
	A4	VCC5	C4	COM4_RXLEDN
LED2	A1	VCC5	C1	COM1_TXLEDN
	A2	VCC5	C2	COM1_RXLEDN
	A3	VCC5	C3	COM2_TXLEDN
	A4	VCC5	C4	COM2_RXLEDN
LED3	A1	VCC5	C1	PWR_LED_N
	A2	VCC3	C2	HDD_LED_N
	A3	BAT_LED_N	C3	GND
	A4	VCC5	C4	GPO_PRO

External I/O Interfaces - Rear Panel

CFast Slot

Connector location: CN4

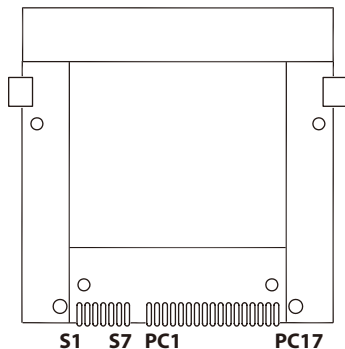

Pin	Definition	Pin	Definition
S1	GND	S2	SATA_TXP0
S3	SATA_TXN0	S4	GND
S5	SATA_RXN0	S6	SATA_RXP0
S7	GND	PC1	GND
PC2	GND	PC3	NC
PC4	NC	PC5	NC
PC6	NC	PC7	GND
PC8	CFAST_LED1_C	PC9	CFAST_ACCESS
PC10	NC	PC11	NC
PC12	NC	PC13	VCC3
PC14	VCC3	PC15	GND
PC16	GND	PC17	CFAST_CDO_C
MH1	GND	MH2	GND

SIM Card Slot

Connector location: IDE1

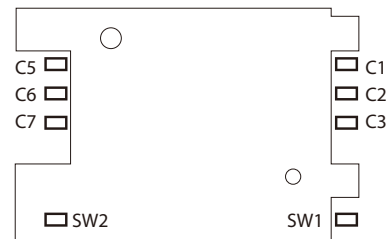

Pin	Definition	Pin	Definition
C1	UIM_PWR	C2	UIM_RESET
C3	UIM_CLK	C5	GND
C6	UIM_VPP	C7	UIM_DATA
SW1	GND	SW2	GND

COM 1 Port (RS232/422/485)

Connector type: DB-9 port, 9-pin D-Sub

Connector location: COM1

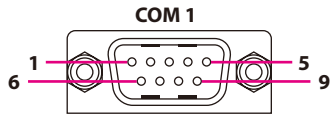

RS232		RS485		RS422	
Pin	Definition	Pin	Definition	Pin	Definition
1	SP1_DCD	1	SP1_DATA-	1	SP1_TX-
2	SP1_RXD	2	SP1_DATA+	2	SP1_TX+
3	SP1_TXD	3	NC	3	SP1_RX+
4	SP1_DTR	4	NC	4	SP1_RX-
5	GND	5	GND	5	GND
6	SP1_DSR	6	NC	6	SP1_RTS-
7	SP1_RTS	7	NC	7	SP1_RTS+
8	SP1_CTS	8	NC	8	SP1_CTS+
9	SP1_RI	9	NC	9	SP1_CTS-
MH2	REAR_GND	MH2	REAR_GND	MH2	REAR_GND
MH1	REAR_GND	MH1	REAR_GND	MH1	REAR_GND

COM 2 Port (RS232/422/485)

Connector type: DB-9 port, 9-pin D-Sub

Connector location: COM2

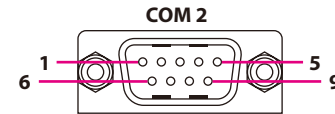

RS232		RS485		RS422	
Pin	Definition	Pin	Definition	Pin	Definition
1	SP2_DCD	1	SP2_DATA-	1	SP2_TX-
2	SP2_RXD	2	SP2_DATA+	2	SP2_TX+
3	SP2_TXD	3	NC	3	SP2_RX+
4	SP2_DTR	4	NC	4	SP2_RX-
5	GND	5	GND	5	GND
6	SP2_DSR	6	NC	6	SP2_RTS-
7	SP2_RTS	7	NC	7	SP2_RTS+
8	SP2_CTS	8	NC	8	SP2_CTS+
9	SP2_RI	9	NC	9	SP2_CTS-
MH2	REAR_GND	MH2	REAR_GND	MH2	REAR_GND
MH1	REAR_GND	MH1	REAR_GND	MH1	REAR_GND

COM 3 and COM 4 Ports (RS232)

Connector type: DB-9 port, 9-pin D-Sub and 1x10 10-pin header, 1mm pitch
 Connector location: COM3 and COM4, J4 and J5

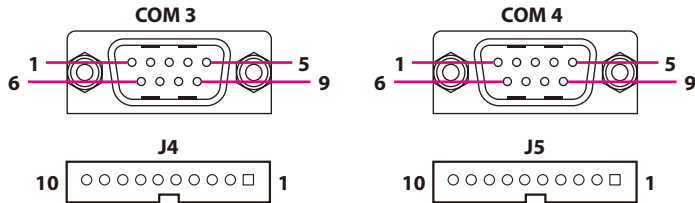

COM3

Pin	Definition	Pin	Definition
1	SP3_DCD	2	SP3_RXD
3	SP3_TXD	4	SP3_DTR
5	GND	6	SP3_DSR
7	SP3_RTS	8	SP3_CTS
9	SP3_RI	10	GND
MH1	GND	MH2	GND

COM4

Pin	Definition	Pin	Definition
1	SP4_DCD	2	SP4_RXD
3	SP4_TXD	4	SP4_DTR
5	GND	6	SP4_DSR
7	SP4_RTS	8	SP4_CTS
9	SP4_RI	10	GND
MH1	GND	MH2	GND

DisplayPort

Connector type: DisplayPort
 Connector location: U2

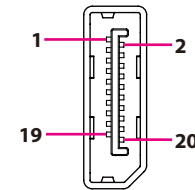

Pin	Definition	Pin	Definition
1	DDI1TXN3_C	2	GND
3	DDI1TXP3_C	4	DDI1TXN2_C
5	GND	6	DDI1TXP2_C
7	DDI1TXN1_C	8	GND
9	DDI1TXP1_C	10	DDI1TXN0_C
11	GND	12	DDI1TXP0_C
13	NC	14	NC
15	DDI1_AUXP_C	16	GND
17	DDI1_AUXN_C	18	DP_HPDC
19	GND	20	VCC3

Remote SW/Remote S3 Connector

Connector type: 4-pin terminal block

Connector location: JP1

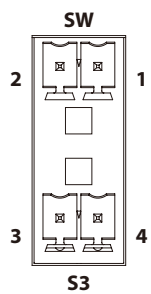

Pin	Definition	Pin	Definition
1	GND	2	PBT_TR
3	REMOTE_S3	4	GND

Internal Connectors

SATA Connector

Connector type: Standard Serial ATA 7P (1.27mm, SATA-M-180)

Connector location: CN2

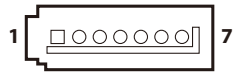

Pin	Definition	Pin	Definition
1	GND	2	SATA_TXP1
3	SATA_TXN1	4	GND
5	SATA_RXN1	6	SATA_RXP1
7	GND		

SATA Power Connector

Connector type: 1x2 2-pin header, 2.5mm pitch

Connector location: J1

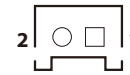

Pin	Definition
1	VCC5
2	GND

Fan Connector

Connector type: 1x2 2-pin header, 2.54mm pitch

Connector location: CN3



Pin	Definition
1	GND
2	VCC12

GPS Connector

Connector type: 1x6 6-pin header, 1mm pitch

Connector location: J3



Pin	Definition	Pin	Definition
1	3VSB	2	NC
3	COM3_TXD	4	COM3_RXD
5	GND	6	VCC3
MH1	GND	MH2	GND

CMOS Battery Connector

Connector type: 1x2 2-pin header, 1.25mm pitch

Connector location: J7



Pin	Definition	Pin	Definition
1	GND	2	VRTC_BAT
MH1	GND	MH2	GND

Port 80 Connector

Connector type: 1x10 10-pin header, 1.0mm pitch

Connector location: J6



Pin	Definition	Pin	Definition
1	GND	2	PLTRST_3P3#
3	LPC_CLK0_DEBUG	4	LPC_FRAME#
5	LPC_AD3	6	LPC_AD2
7	LPC_AD1	8	LPC_AD0
9	VCC3	10	VCC3
MH1	GND	MH2	GND

Flash BIOS

Connector type: 2x3 6-pin Wafer, 2.0mm pitch

Connector location: JFW1

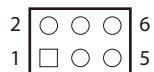

Pin	Definition	Pin	Definition
1	V1P8A	2	GND
3	SPIO_CS#	4	SPIO_CLK
5	SPIO_MISO	6	SPIO_MOSI

LED Pin Header

Connector type: 2x7 14-pin header, 2.0mm pitch

Connector location: JP8

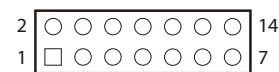

Pin	Definition	Pin	Definition
1	PWR_LED_N	2	POWER_LED_PWR
3	HDD_LED_N	4	HDD_LED_PWR
5	SMB_3P3_CLK	6	SMB_3P3_DAT
7	3VSB	8	GND
9	SLP_S3_3P3#	10	PS_ON
11	PBT_TR	12	GND
13	PMU_RSTBTN#	14	GND

Reset Button Connector

Connector type: 1x2 2-pin header, 2.0mm pitch

Connector location: JP9



Pin	Definition
1	LPC_WDT#
2	GND

GPIO Pin Header

Connector type: 2x5 10-pin header, 2.00mm pitch

Connector location: JP7

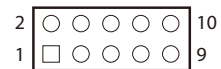

Pin	Definition	Pin	Definition
1	VCC5	2	GND
3	ICH_GPO0_OUT	4	ICH_GPIO_IN
5	ICH_GPO1_OUT	6	ICH_GPI1_IN
7	ICH_GPO2_OUT	8	ICH_GPI2_IN
9	ICH_GPO3_OUT	10	ICH_GPI3_IN

Line-out Pin Header

Connector type: 1x4 4-pin header, 2.0mm pitch
Connector location: JP4



Pin	Definition
1	LOUT_R3
2	EXLINEOUT_JD
3	LINE_GND
4	LOUT_L3

Mic-in Pin Header

Connector type: 1x4 4-pin header, 2.0mm pitch
Connector location: JP5



Pin	Definition
1	MIC1_R3
2	MIC1_JD
3	MIC_GND
4	MIC1_L3

Line-in Pin Header

Connector type: 1x4 4-pin header, 2.0mm pitch

Connector location: JP6



Pin	Definition
1	FLIN_L
2	LIN_JD
3	LIN_GND
4	FLIN_R

COM2 5V/12V/RI Pin Header

Connector type: 1x5 5-pin header, 2.0mm pitch

Connector location: J2



Pin	Definition	Pin	Definition
1	VCC5	2	SP2_RI_T
3	VCC12	4	SP2_RI_T
5	SP2_RI		

GSM Mini-PCle Earout Pin Header

Connector type: 1x2 2-pin header, 2.0mm pitch

Connector location: JP3



Pin	Definition
1	EAROUTN
2	EAROUTP

GSM Mini-PCle Mic-in Pin Header

Connector type: 1x2 2-pin header, 2.0mm pitch

Connector location: JP2



Pin	Definition
1	MICINP
2	MICINN

Mini-PCle Connector (3G/Wi-Fi)

Connector location: CN1

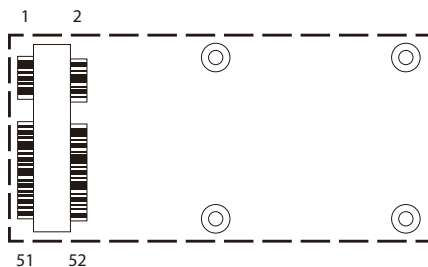

Pin	Definition	Pin	Definition
1	WAKE_3P3#	2	3VSB_MINI1
3	NC	4	GND
5	NC	6	V1P5S_MINI1
7	PCIE_CLKREQ#2	8	UIM_PWR
9	GND	10	UIM_DATA
11	PCIE_CLKN2	12	UIM_CLK
13	PCIE_CLKP2	14	UIM_RESET
15	GND	16	UIM_VPP
17	NC	18	GND
19	NC	20	3VSB_MINI1
21	GND	22	PLTRST_3P3#
23	PCIE_RXN2	24	3VSB_MINI1
25	PCIE_RXP2	26	GND

Pin	Definition	Pin	Definition
27	GND	28	V1P5S_MINI1
29	GND	30	SMB_3P3_CLK
31	PCIE_TXN2	32	SMB_3P3_DAT
33	PCIE_TXP2	34	GND
35	GND	36	USB_4N
37	GND	38	USB_4P
39	3VSB_MINI1	40	GND
41	3VSB_MINI1	42	NC
43	GND	44	NC
45	MCLK	46	NC
47	PCMO	48	V1P5S_MINI1
49	PCMI	50	GND
51	PCMSYNC	52	3VSB_MINI1

CHAPTER 3: SYSTEM SETUP

Removing the Chassis Cover



Prior to removing the chassis cover, make sure the unit's power is off and disconnected from the power sources to prevent electric shock or system damage.

1. Locate the 6 screws on the bottom side of the chassis cover.

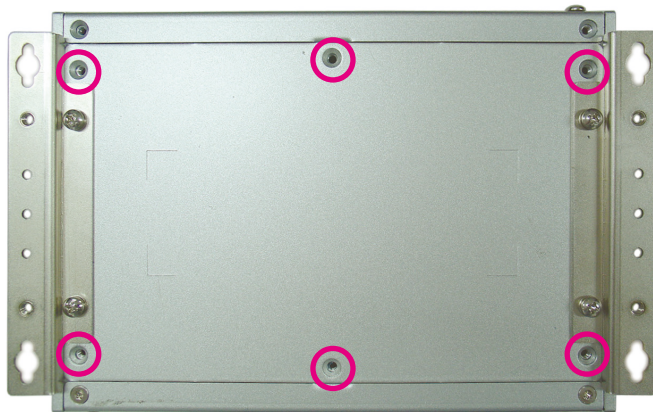

2. Remove all the 6 screws on the bottom side of the chassis cover.

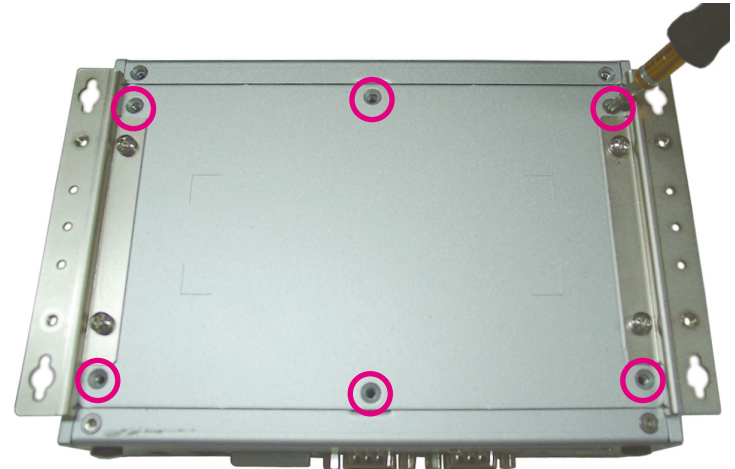

3. Remove the chassis cover.



Installing a SO-DIMM Memory Module



Remove the bottom cover before installing a SO-DIMM.

1. Remove the HDD bracket.

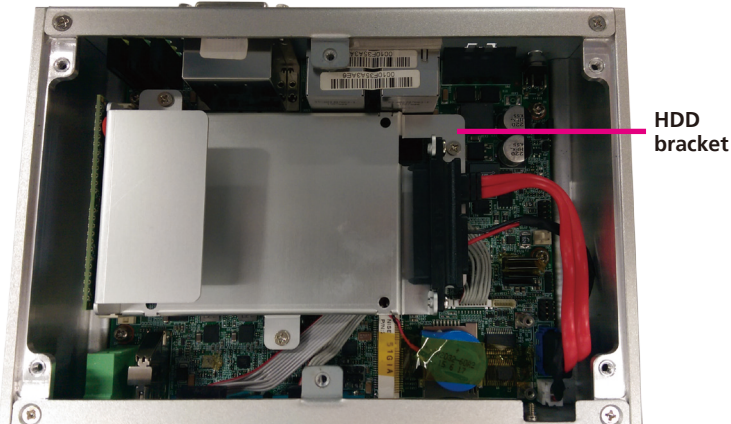

2. Locate the SO-DIMM socket.

3. Insert the SO-DIMM memory module into the socket and push the module down until a clicking sound is heard.

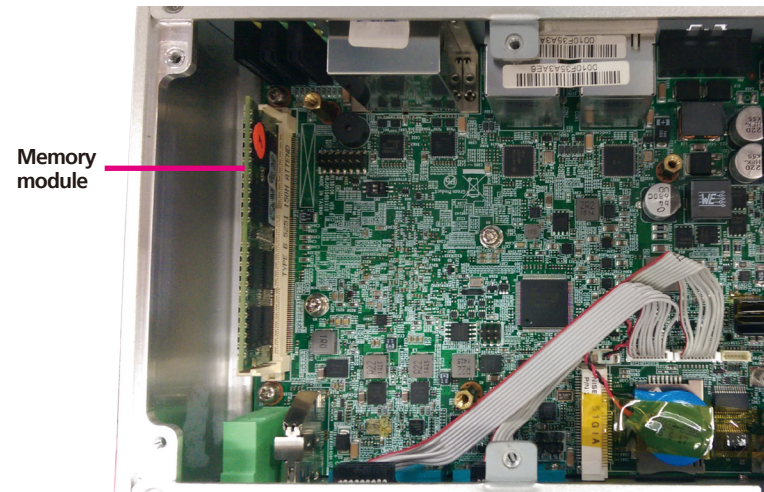

Installing a Wireless LAN Module (Half-size)

1. Locate the mini-PCIe slot on the board.

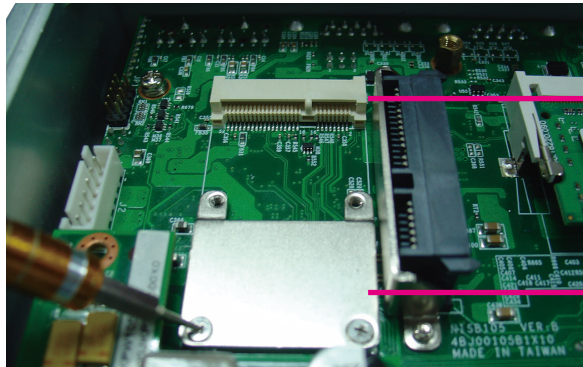

Mini-PCIe slot

Mini-PCIe bracket

2. Remove the mini-PCIe bracket from the board.

3. Install the mini-PCIe bracket to the mini-PCIe module.

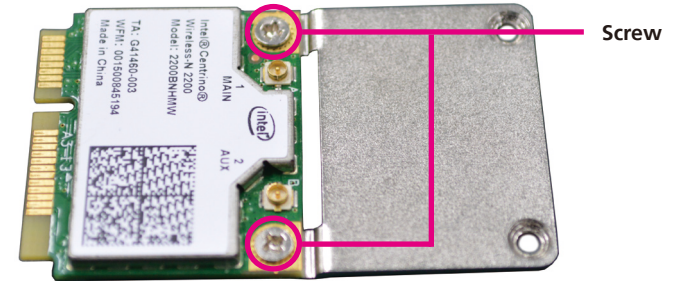

Screw

4. Insert the mini-PCIe module into the mini-PCIe slot at 45 degree angle until the gold-plated connector on the edge of the module completely disappears into the slot.



5. Push the module down and secure it with the screws.



Installing a Wireless LAN Module (Full-size)

1. Locate the mini-PCIe slot on the board and remove the mini-PCIe bracket.

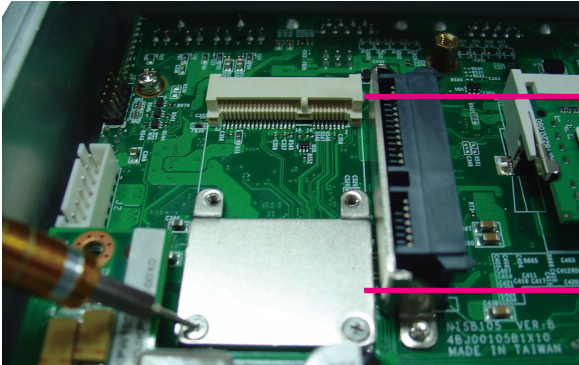

Mini-PCIe slot

Mini-PCIe bracket

2. Insert the mini-PCIe module into the mini-PCIe slot at 45 degree angle until the gold-plated connector on the edge of the module completely disappears into the slot.



3. Push the module down and secure it with the screws.

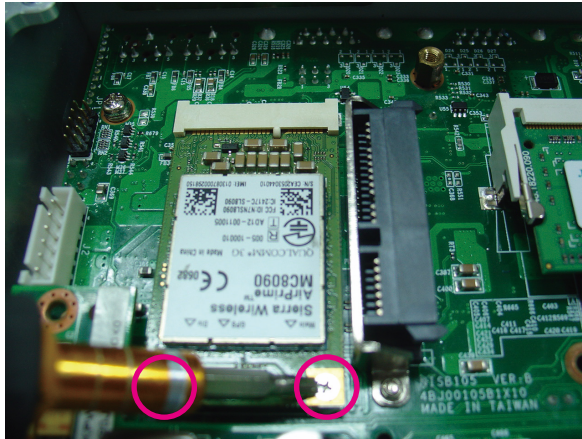

Installing a SIM Card

1. Remove the CFast/SIM card cover.

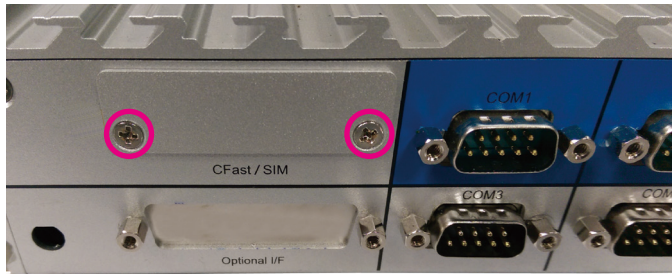

2. Insert the SIM card into the SIM card slot.

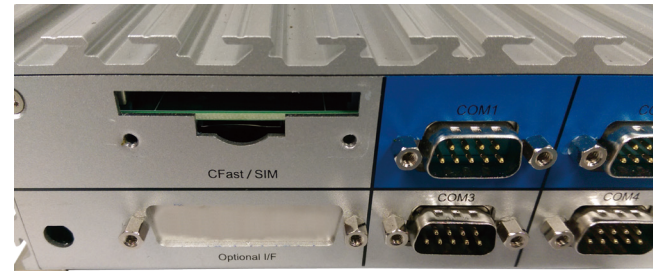

3. Close the cover and secure it to the original position.

Installing a SATA Hard Drive



Remove the bottom cover before installing a SATA HDD.

1. Locate the internal HDD bracket and remove all the 3 screws on the bracket.

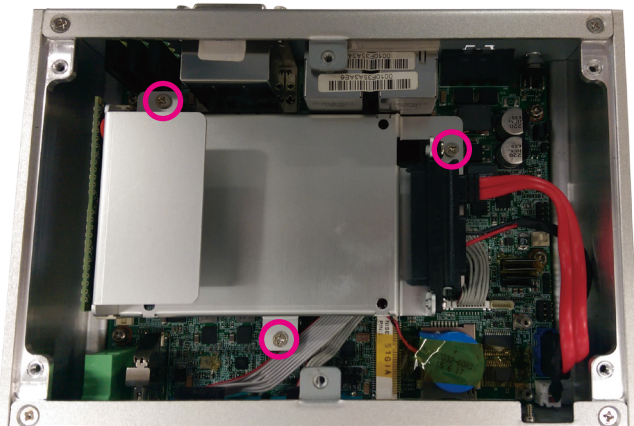

2. Place the 2.5" HDD into the internal HDD bracket then use the screws to secure the 2.5" HDD in place.

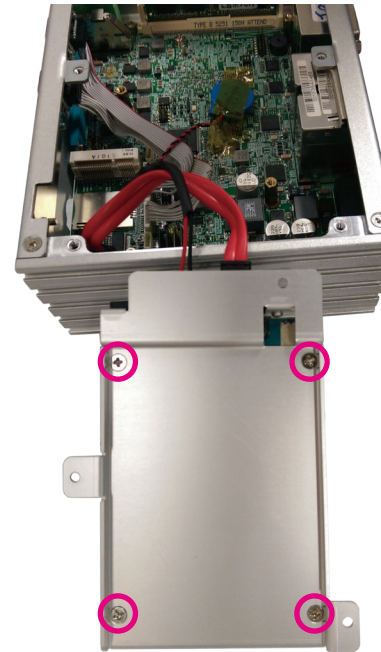

3. Place the internal HDD bracket back to its original position and secure it with screws.

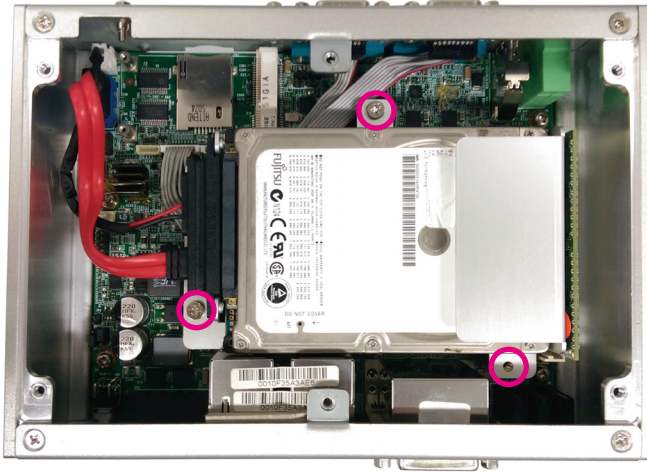

Installing a CFast Card

1. Remove the CFast/SIM card cover.

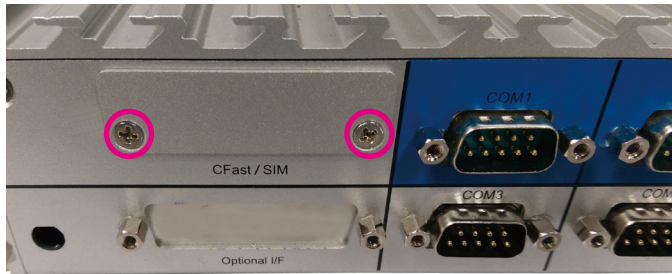

2. Insert the CFast card into the CFast slot.

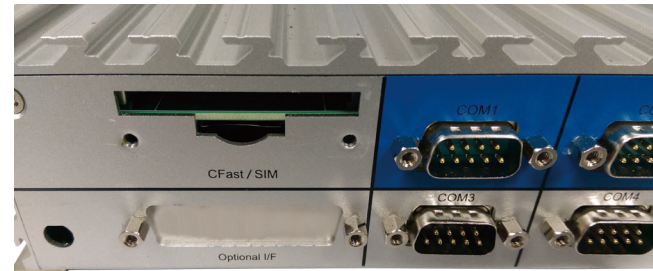

3. Close the cover and secure it to the original position.

Packing



NISE 106 plastic bag and EPE reference.

Front View of Packing

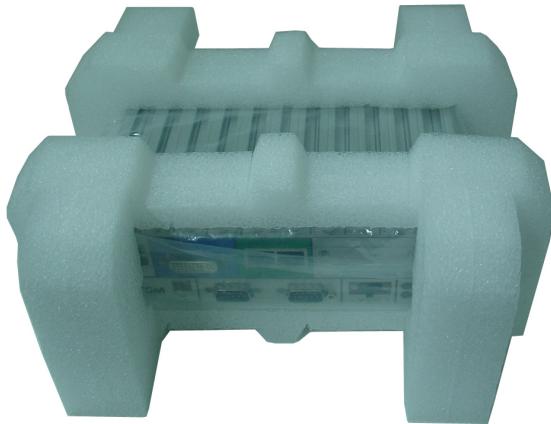

Rear View of Packing



Top View of Packing

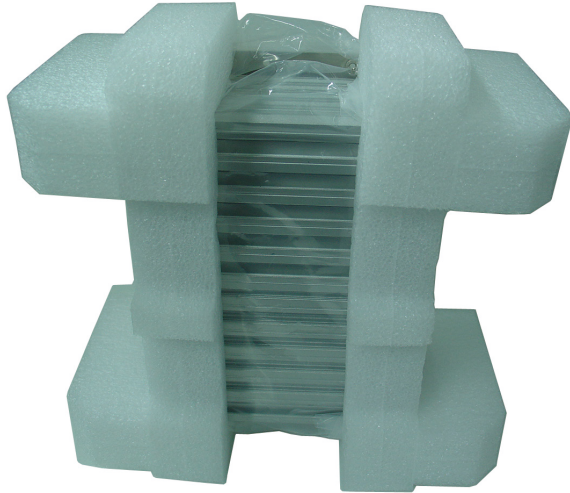

Bottom View of Packing



CHAPTER 4: BIOS SETUP

This chapter describes how to use the BIOS setup program for the NISE 106. The BIOS screens provided in this chapter are for reference only and may change if the BIOS is updated in the future.

To check for the latest updates and revisions, visit the NEXCOM website at www.nexcom.com.tw.

About BIOS Setup

The BIOS (Basic Input and Output System) Setup program is a menu driven utility that enables you to make changes to the system configuration and tailor your system to suit your individual work needs. It is a ROM-based configuration utility that displays the system's configuration status and provides you with a tool to set system parameters.

These parameters are stored in non-volatile battery-backed-up CMOS RAM that saves this information even when the power is turned off. When the system is turned back on, the system is configured with the values found in CMOS.

With easy-to-use pull down menus, you can configure such items as:

- Hard drives, diskette drives, and peripherals
- Video display type and display options
- Password protection from unauthorized use
- Power management features

The settings made in the setup program affect how the computer performs. It is important, therefore, first to try to understand all the setup options, and second, to make settings appropriate for the way you use the computer.

When to Configure the BIOS

- This program should be executed under the following conditions:
 - When changing the system configuration
 - When a configuration error is detected by the system and you are prompted to make changes to the setup program
 - When resetting the system clock
 - When redefining the communication ports to prevent any conflicts
 - When making changes to the Power Management configuration
 - When changing the password or making other changes to the security setup

Normally, CMOS setup is needed when the system hardware is not consistent with the information contained in the CMOS RAM, whenever the CMOS RAM has lost power, or the system features need to be changed.

Default Configuration

Most of the configuration settings are either predefined according to the Load Optimal Defaults settings which are stored in the BIOS or are automatically detected and configured without requiring any actions. There are a few settings that you may need to change depending on your system configuration.

Entering Setup











When the system is powered on, the BIOS will enter the Power-On Self Test (POST) routines. These routines perform various diagnostic checks; if an error is encountered, the error will be reported in one of two different ways:

- If the error occurs before the display device is initialized, a series of beeps will be transmitted.
- If the error occurs after the display device is initialized, the screen will display the error message.

Powering on the computer and immediately pressing allows you to enter Setup.

Press the  key to enter Setup:

Legends

Key	Function
	Moves the highlight left or right to select a menu.
	Moves the highlight up or down between sub-menus or fields.
	Exits the BIOS Setup Utility.
	Scrolls forward through the values or options of the highlighted field.
	Scrolls backward through the values or options of the highlighted field.
	Selects a field.
	Displays General Help.
	Load previous values.
	Load optimized default values.
	Saves and exits the Setup program.
	Press <Enter> to enter the highlighted sub-menu

Scroll Bar

When a scroll bar appears to the right of the setup screen, it indicates that there are more available fields not shown on the screen. Use the up and down arrow keys to scroll through all the available fields.

Submenu

When “▶” appears on the left of a particular field, it indicates that a submenu which contains additional options are available for that field. To display the submenu, move the highlight to that field and press  .

BIOS Setup Utility

Once you enter the AMI BIOS Setup Utility, the Main Menu will appear on the screen. The main menu allows you to select from several setup functions and one exit. Use arrow keys to select among the items and press  to accept or enter the submenu.

Main

The Main menu is the first screen that you will see when you enter the BIOS Setup Utility.

System Date

The date format is <day>, <month>, <date>, <year>. Day displays a day, from Monday to Sunday. Month displays the month, from January to December. Date displays the date, from 1 to 31. Year displays the year, from 1999 to 2099.

System Time

The time format is <hour>, <minute>, <second>. The time is based on the 24-hour military-time clock. For example, 1 p.m. is 13:00:00. Hour displays hours from 00 to 23. Minute displays minutes from 00 to 59. Second displays seconds from 00 to 59.

Aptio Setup Utility - Copyright (C) 2015 American Megatrends, Inc.					
Main	Advanced	Chipset	Security	Boot	Save & Exit
BIOS Information		American Megatrends		Set the Date. Use Tab to switch between Date elements.	
BIOS Vendor	5.11				
Core Version	UEFI 2.4; PI 1.3				
Compliancy	N106-002 x64				
Project Version	08/21/2015 11:06:21				
Build Date and Time					
CPU Configuration		33c			
Microcode Patch					
Memory Information		4096 MB			
Total Memory					
GOP Information		[N/A]		←→: Select Screen ↑↓: Select Item Enter: Select +/-: Change Opt. F1: General Help F2: Previous Values F3: Optimized Defaults F4: Save & Exit ESC: Exit	
Intel(R) GOP Driver					
TXE Information		00.05.00.00			
Sec RC Version	02.00.00.2056				
TXE FW Version					
System Date	[Mon 11/09/2015]				
System Time	[13:37:26]				
Version 2.17.1249. Copyright (C) 2015 American Megatrends, Inc.					

Advanced

The Advanced menu allows you to configure your system for basic operation. Some entries are defaults required by the system board, while others, if enabled, will improve the performance of your system or let you set some features according to your preference.



Setting incorrect field values may cause the system to malfunction.

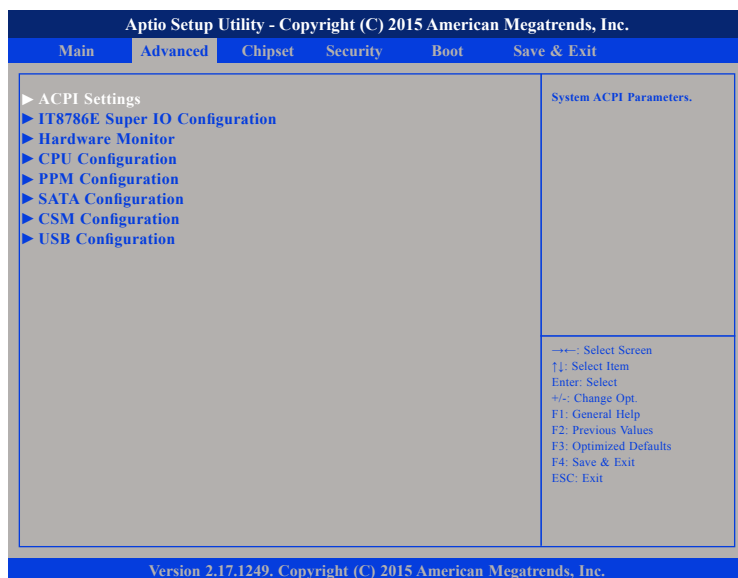

ACPI Settings

This section is used to configure ACPI Settings.

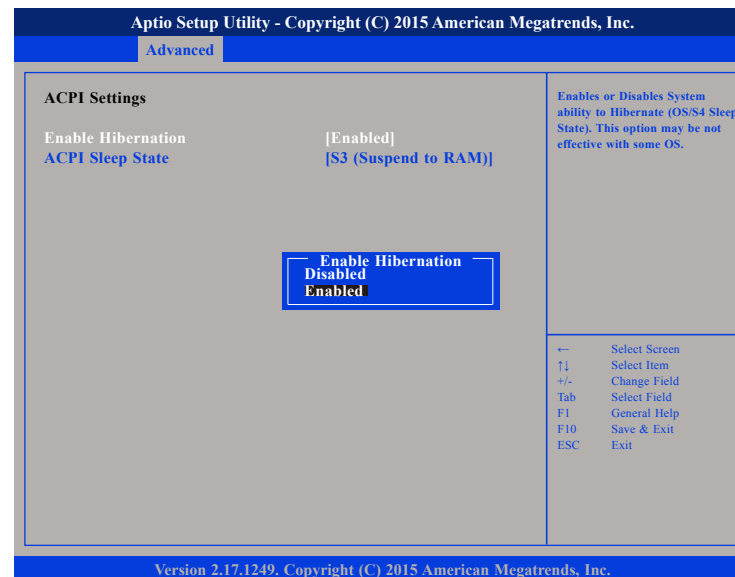

Enable Hibernation

Enables or disables system ability to hibernate (OS/S4 Sleep State). This option may not be effective with some OS.

ACPI Sleep State

Select the highest ACPI sleep state the system will enter when the suspend button is pressed. The options are Suspend Disabled and S3 (Suspend to RAM).

IT8786E Super IO Configuration

This section is used to configure the serial ports.



Super IO Chip

Displays the Super I/O chip used on the board.

Serial Port 1 Configuration

This section is used to configure serial port 1.



Serial Port

Enables or disables the serial port.

Onboard Serial Port Mode

Select this to change the serial port mode to RS232, RS422, RS485 or RS485 Auto.

Serial Port 2 Configuration

This section is used to configure serial port 2.



Serial Port

Enables or disables the serial port.

Onboard Serial Port Mode

Select this to change the serial port mode to RS232, RS422, RS485 or RS485 Auto.

Serial Port 3 Configuration

This section is used to configure serial port 3.

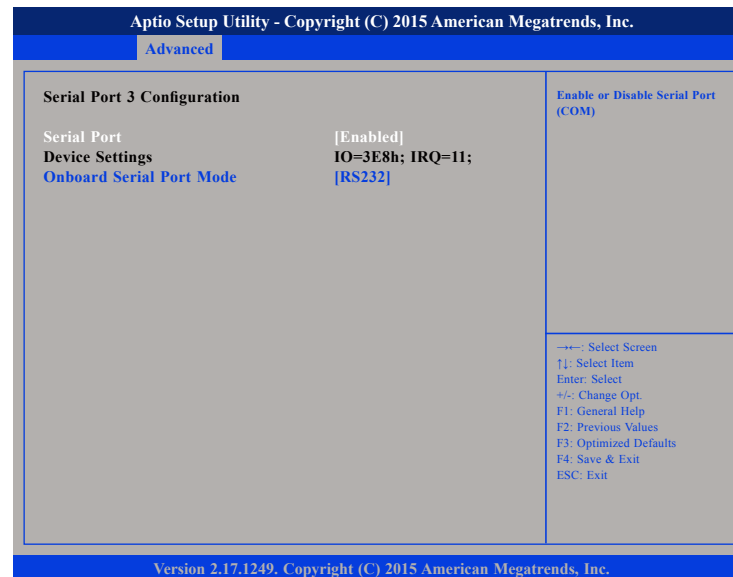

Serial Port

Enables or disables the serial port.

Onboard Serial Port Mode

Select this to change the serial port mode to RS232 or GPS

Serial Port 4 Configuration

This section is used to configure serial port 4.



Serial Port

Enables or disables the serial port.

PPM Configuration

This section is used to configure the Processor Power Management (PPM) configuration.



EIST

Enables or disables Intel® SpeedStep.

Hardware Monitor

This section is used to monitor hardware status such as temperature, fan speed and voltages.

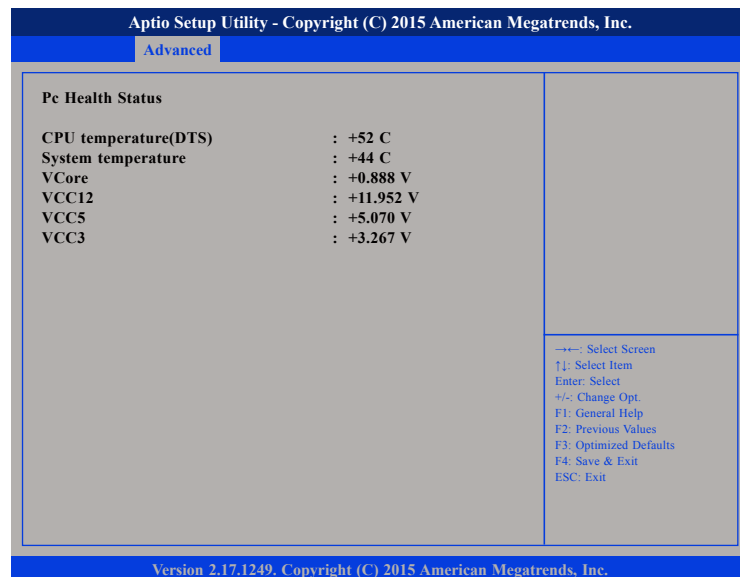

VCC12

Detects and displays 12V voltage.

VCC5

Detects and displays 5V voltage.

VCC3

Detects and displays 3.3V voltage.

CPU Temperature(DTS)

Detects and displays the current CPU temperature.

System Temperature

Detects and displays the current system temperature.

VCore

Detects and displays the Vcore CPU voltage.

CPU Configuration

This section is used to configure the CPU.



Socket 0 CPU Information

Display information on the CPU installed on socket 0.

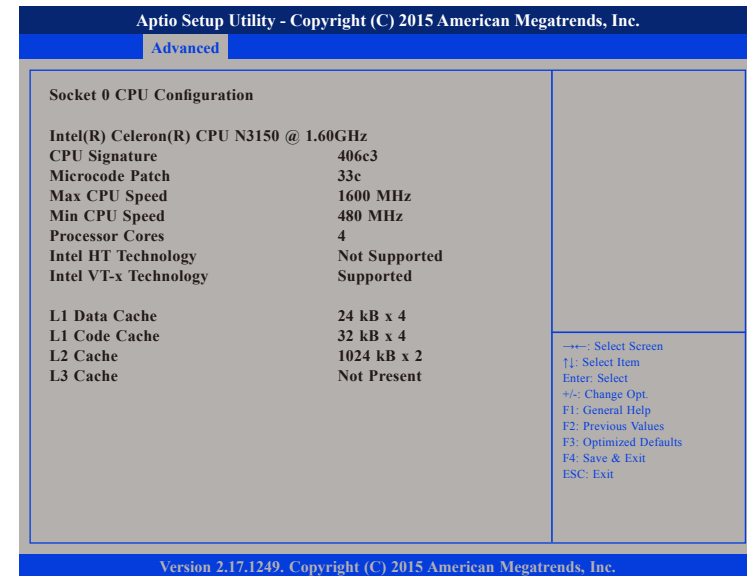

Limit CPUID Maximum

The CPUID instruction of some newer CPUs will return a value greater than 3. The default is Disabled because this problem does not exist in the Windows series operating systems. If you are using an operating system other than Windows, this problem may occur. To avoid this problem, enable this field to limit the return value to 3 or lesser than 3.

Intel® Virtualization Technology

Enables or disables Intel® Virtualization technology.

SATA Configuration

This section is used to configure the SATA drives.

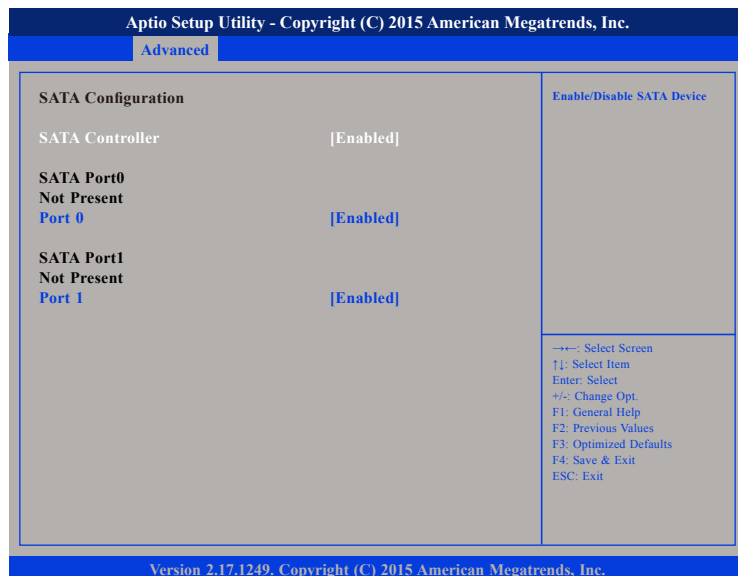

SATA Controller

Enables or disables the SATA controller.

Port 0 and Port 1

Enables or disables SATA port 0 and port 1.

CSM Configuration

This section is used to configure the compatibility support module features.

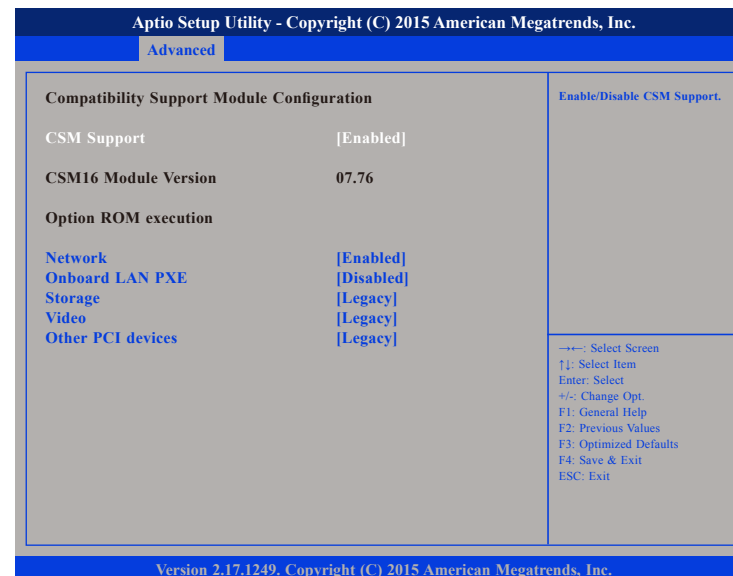

CSM Support

Enables or disables CSM support.

Network

Controls the execution of UEFI and legacy PXE OpROM.

Onboard LAN PXE

Enables or disables onboard LAN PXE ROM.

Storage

Controls the execution of UEFI and legacy storage OpROM.

Video

Controls the execution of UEFI and legacy video OpROM.

Other PCI Devices

Determines OpROM execution policy for devices other than network, storage or video.

USB Configuration

This section is used to configure the USB.

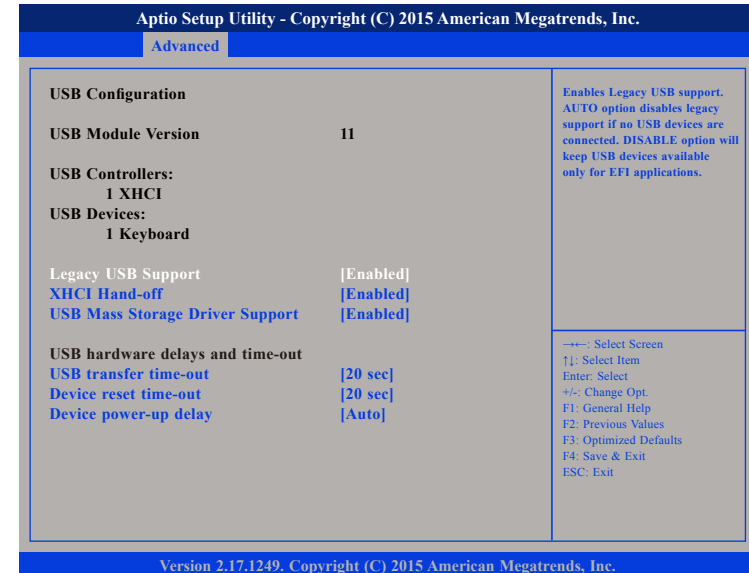

Legacy USB Support

Enable Enables Legacy USB.

Auto Disables support for Legacy when no USB devices are connected.

Disable Keeps USB devices available only for EFI applications.

XHCI Hand-off

This is a workaround for OSs that does not support XHCI hand-off. The XHCI ownership change should be claimed by the XHCI driver.

USB Mass Storage Driver Support

Enables or disables USB mass storage driver support.

USB Transfer Time-out

The time-out value for control, bulk, and Interrupt transfers.

Device Reset Time-out

Selects the USB mass storage device's start unit command timeout.

Device Power-up Delay

Maximum time the value will take before it properly reports it self to the Host Controller. "Auto" uses default value: for a Root port it is 100ms, for a Hub port the delay is taken from Hub descriptor.

Chipset

This section gives you functions to configure the system based on the specific features of the chipset. The chipset manages bus speeds and access to system memory resources.



WWAN Digital Voice Interface

Configures the interface for WWAN digital voice.

South Bridge

Enters the South Bridge submenu.

South Bridge

This section is used to configure the south bridge features.



USB Power State in S5

Configures the USB power state in S5.

Restore AC Power Loss

- | | |
|------------|--|
| Power Off | When power returns after an AC power failure, the system's power is off. You must press the power button to power-on the system. |
| Power On | When power returns after an AC power failure, the system will automatically power-on. |
| Last State | When power returns after an AC power failure, the system will return to the state where you left off before power failure occurs. If the system's power is off when AC power failure occurs, it will remain off when power returns. If the system's power is on when AC power failure occurs, the system will power-on when power returns. |

Security Configuration



RTC Lock

Enables or disables bytes 38h-3Fh in the upper and lower 128-byte bank of RTC RAM lockdown.

BIOS Lock

Enables or disables BIOS lock enable (BLE) feature.

Global SMI Lock

Enables or disables global SMI lock.

PCH Azalia Configuration



Azalia

Control detection of the Azalia device.

Disabled Azalia will be unconditionally disabled.
 Enabled Azalia will be unconditionally enabled.

Azalia HDMI Codec

Enables or disables internal HDMI codec for Azalia.

USB Configuration



XHCI Mode

Configures the operation mode of the XHCI controller.

PCI Express Configuration

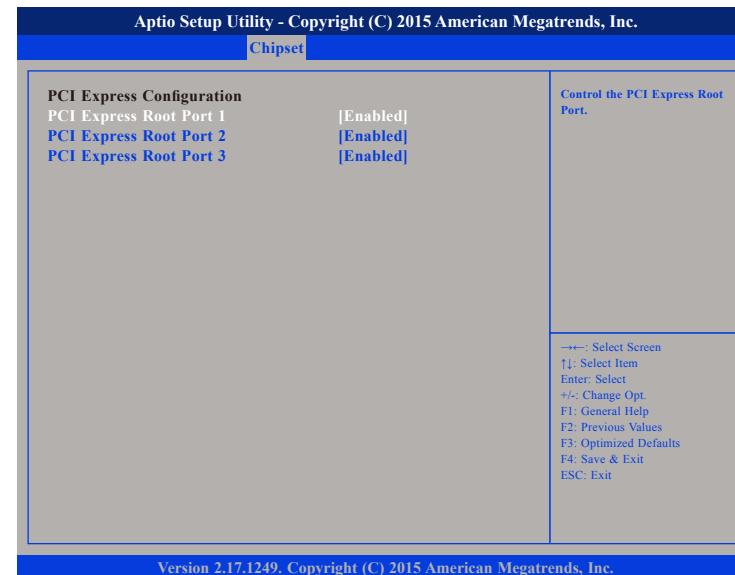

PCI Express Port 1 to PCI Express Port 3

Enables or disables the PCI Express ports 1 to 3 on the chipset.

Security



Administrator Password

Select this to reconfigure the administrator's password.

User Password

Select this to reconfigure the user's password.

Boot

This section is used to configure the boot features.

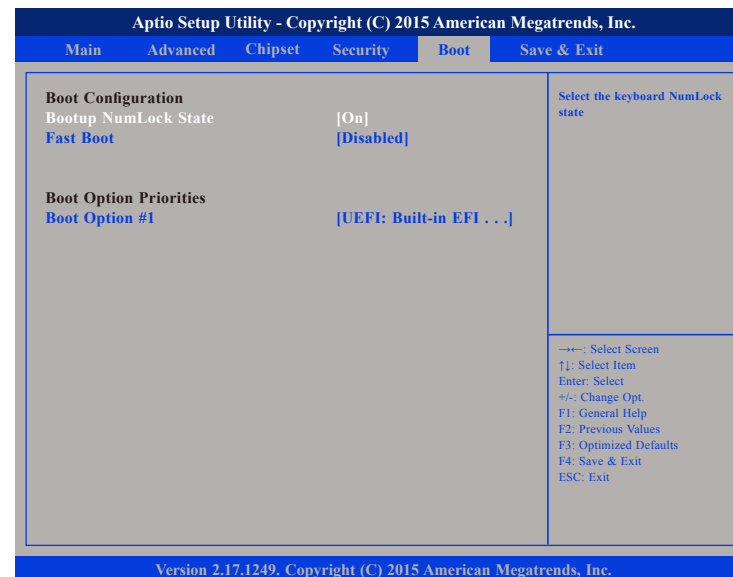

Bootup NumLock State

This allows you to determine the default state of the numeric keypad. By default, the system boots up with NumLock on wherein the function of the numeric keypad is the number keys. When set to Off, the function of the numeric keypad is the arrow keys.

Fast Boot

When enabled, the BIOS will shorten or skip some check items during POST. This will decrease the time needed to boot the system.

Boot Option Priorities

Adjust the boot sequence of the system. Boot Option #1 is the first boot device that the system will boot from, next will be #2 and so forth.

Save & Exit



Save Changes and Reset

To save the changes and reset, select this field then press <Enter>. A dialog box will appear. Confirm by selecting Yes.

Discard Changes and Reset

To exit the Setup utility without saving the changes, select this field then press <Enter>. You may be prompted to confirm again before exiting.

Restore Defaults

To restore the BIOS to default settings, select this field then press <Enter>. A dialog box will appear. Confirm by selecting Yes.

APPENDIX A: POWER CONSUMPTION

Test Equipment/Software

System Configuration	Sys#1
Chassis	Chassis NISE 106 VER:A
CPU	Intel® Pentium® N3700 (1 or 2 MB L2 cache, Up to 1.6 GHz)
Memory	DDR3 1600 SO-DIMM Micron E-die ADATA: AD3S1600W4G11-BMIE
CPU board	N/A
Mother board	NISB 106 REV:B
HDD	WDC WD5000BPKX-00HPJT0
FDD	N/A
CD-ROM	N/A
CFast	TS16GCFX5001
Power Supply	Laboratory DC Power Supply GWINSTEK GPC-60300
Add-on Card	N/A
CPU Cooler	NISE 106 CPU Heatsink SHYUNG SHUHN
System FAN	N/A
Keyboard	Microsoft Wired Keyboard 600
Mouse	Microsoft Basic Optical Mouse
Monitor	ASUS VS228

Function Port Fixture

	Front Panel	Rear Panel
USB 2.0 x3	N/A	N/A
USB 3.0 x4	5V,1A (Cement Resistor)	N/A
DisplayPort x1	N/A	No Fixture
HDMI	LCD Monitor (HDMI)	N/A
COM1 ~ COM4	COM1,COM2 COM3,COM4 RS232 Loopback (115200 baud rate)	N/A
DVI	LCD Monitor (DVI -I)	N/A
LAN1, LAN2	Gigabit Loopback	N/A
Audio & Mic	N/A	N/A

Power Consumption Management

Purpose

The purpose of the power consumption test is to verify the power dissipation of system, and the loading of power supply.

Test Equipment

PROVA CM-07 AC/DC CLAMP METER

Device Under Test

DUT: sys#1/ sys#2

Test Procedure

1. Power up the DUT, boot into Windows 8 x64 Pro.
2. Entering standby mode (HDD power down).
3. Measure the power consumption and record it.
4. Run Burn-in test program to apply 100% full loading.
5. Measure the power consumption and record it.

Test Data

	Sys #1	Sys #1
	+30V	+9V
Full-Loading Mode	1.13A	3.89A
Total	33.9W	35.1W
Standby S3 Mode	0.16A	0.27A
Total	4.8W	2.4W

APPENDIX B: LED PROGRAMMING GUIDE

LEDs are provided for custom system design. This appendix provides definitions and its default setting for the LEDs in the NISE 106 series.

The LED definition is shown in the following table:

Pin	PowerOn Default	Address
LED	High	A07h (Bit5)

Control the LED level from I/O port A07h bit5.

The bit is Set/Clear indicated output High/Low.

APPENDIX C: WATCHDOG TIMER SETTING

ITE8786 WatchDog Programming Guide

```
#define SUPERIO_PORT 0x2E
#define WDT_SET 0x72
#define WDT_VALUE 0x73

void main(void)
{
    #Enter SuperIO Configuration
    outputb(SUPERIO_PORT, 0x87);
    outputb(SUPERIO_PORT, 0x01);
    outputb(SUPERIO_PORT, 0x55);
    outputb(SUPERIO_PORT, 0x55);

    # Set LDN
    outputb(SUPERIO_PORT, 0x07);
    outputb(SUPERIO_PORT+1, 0x07);

    # Set WDT setting
    outputb(SUPERIO_PORT, WDT_SET);
    outputb(SUPERIO_PORT+1, 0x90);           # Use the second
                                           # Use the minute, change value to 0x10

    # Set WDT sec/min
    outputb(SUPERIO_PORT, WDT_VALUE);
    outputb(SUPERIO_PORT+1, 0x05);         #Set 5 seconds
}
```

APPENDIX D: GPIO PROGRAMMING GUIDE

GPIO (General Purpose Input/Output) pins are provided for custom system design. This appendix provides definitions and its default setting for the ten GPIO pins in the NISE 106 series. The pin definition is shown in the following table:

Pin	GPIO mode	PowerOn Default	Address	Pin	GPIO mode	Address
1	VCC	-	-	2	GND	-
3	GPO0	Low	A03h (Bit6)	4	GPI0	A03h (Bit1)
5	GPO1	Low	A02h (Bit5)	6	GPI1	A05h (Bit5)
7	GPO2	Low	A07h (Bit0)	8	GPI2	A05h (Bit4)
9	GPO3	Low	A07h (Bit1)	10	GPI3	A00h (Bit1)

Control the GPO 0/1/2/3 level from I/O port A03h bit6/ A02h bit5 A07h bit0/ A07h bit1.

The bit is Set/Clear indicated output High/Low.

GPIO programming sample code

```
#define GPO0      (0x01 << 6)
#define GPO1      (0x01 << 5)
#define GPO2      (0x01 << 0)
#define GPO3      (0x01 << 1)

#define GPO0_HI   outputb(0xA03, GPO0)
#define GPO0_LO   outputb(0xA03, 0x00)
#define GPO1_HI   outputb(0xA02, GPO1)
#define GPO1_LO   outputb(0xA02, 0x00)
#define GPO2_HI   outputb(0xA07, GPO2)
#define GPO2_LO   outputb(0xA07, 0x00)
#define GPO3_HI   outputb(0xA07, GPO3)
#define GPO3_LO   outputb(0xA07, 0x00)

void main(void)
{
    GPO0_HI;
    GPO1_LO;
    GPO2_HI;
    GPO3_LO;
}
```