

LE-371

3.5 inch Motherboard

User's Manual

Edition 1.0
2016/10/11

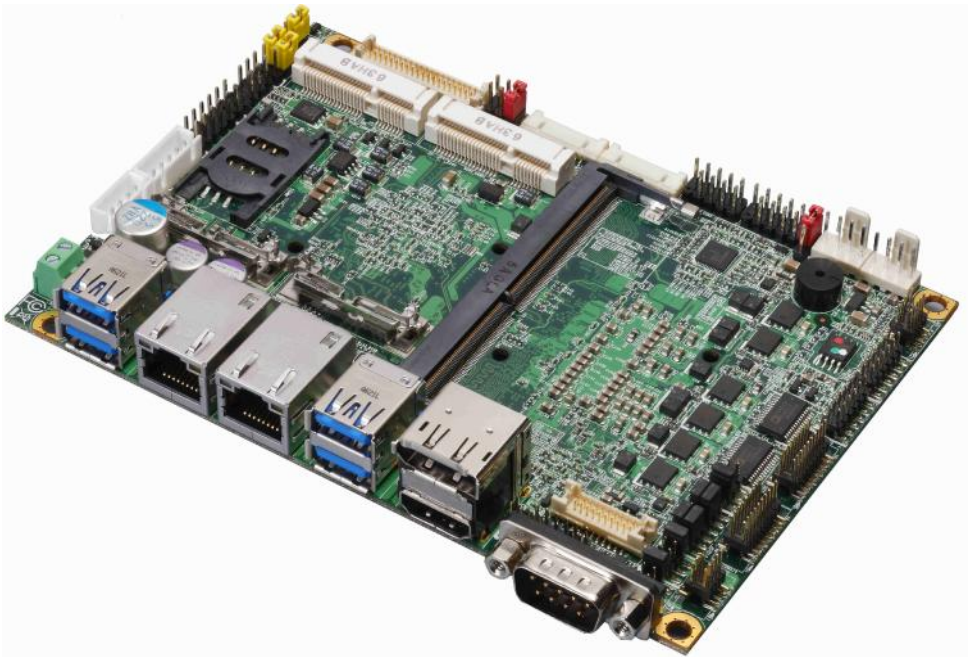

Copyright

Copyright 2015, all rights reserved. This document is copyrighted and all rights are reserved. The information in this document is subject to change without prior notice to make improvements to the products.

This document contains proprietary information and protected by copyright. No part of this document may be reproduced, copied, or translated in any form or any means without prior written permission of the manufacturer.

All trademarks and/or registered trademarks contains in this document are property of their respective owners.

Disclaimer

The company shall not be liable for any incidental or consequential damages resulting from the performance or use of this product.

The company does not issue a warranty of any kind, express or implied, including without limitation implied warranties of merchantability or fitness for a particular purpose.

The company has the right to revise the manual or include changes in the specifications of the product described within it at any time without notice and without obligation to notify any person of such revision or changes.

Trademark

All trademarks are the property of their respective holders.

Any questions please visit our website at <http://www.commell.com.tw>

Packing List:

Please check the package content before you starting using the board.



1 x LE-371 Motherboard
(Include Heat spreader for LE-371S series)
(Include Fan for LE-371F series)



1 x Audio cable
(OALPJ-HDUNB / 1040123)



2 x SATA CABLE
(OALSATA3-H10-L35 / 1040523)



1 x COM Cable
(OALES-BKU1NB / 1040086)



1 x PS/2 Keyboard & Mouse cable
(OALPS2/KM / 1040131)



1 x DVI module with bracket
(BADPDVIP_A & OALDVI-DF13)
(4120008021 & 1040483)



1 x SATA Power Cable
(OALSATA15-2PJ / 1040613)



1 xDC Input Power Cable
(OALDC-B / 1040513)



1 x VGA Cable
(OALVGA-SNB-7) / (1040557)

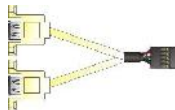

1 xUSB2.0 cable
(OALUSBA-3 / 1040173)
(Optional)

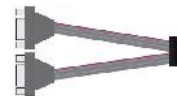

1 x Dual COM cable
(OALES-BKU2NB / 1040090)
(Optional)

Printed Matters:

Driver CD (Including User's Manual) x 1

Index

Chapter 1 <Introduction>	4
1.1 <Product Overview>.....	4
1.2 <Product Specification>	5
1.3 <Block Diagram>.....	6
Chapter 2 <Hardware setup>	7
2.1 <Connector Location and Reference>	7
2.1.1 <Internal connectors list>	8
2.1.2 <External connectors list>	8
2.2 <Memory Setup>.....	9
2.3 <Jumper Location and Reference>	10
2.3.1 <Jumper list>	10
2.3.2 <Clear CMOS and Power on type selection>.....	11
2.4 <I/O interface>	11
2.4.1 <Serial ATA interface>	11
2.4.2 <Ethernet interface>.....	12
2.4.3 <Display interface>	12
2.4.4 <Serial Port interface>	15
2.4.5 <USB interface>.....	18
2.4.6 <Audio interface>	19
2.4.7 <Expansion slot>.....	20
2.4.8 <Front panel switch and indicator>	21
2.4.9 <GPIO and Other interface>	21
2.5 <Power supply>	23
2.5.1 <Power input>.....	23
2.5.2 <Power output>.....	24
Appendix A <Flash BIOS>	25
Appendix B <LCD Panel Type select>	25
Appendix C <Programmable Watch Dog Timer>	27
Appendix D <Hardware monitor >	28
Appendix E <Programmable GPIO >	29
Appendix F <RAID Setting>	30
Contact information	31

Chapter 1 <Introduction>

1.1 <Product Overview>

LE-37I is 3.5 inch Motherboard which supports 6th Generation Intel® Core™ i7, i5, i3, H-series Processor with Intel® QM170 Chipset, integrated HD Graphics 530, DDR4 memory, Realtek High Definition Audio, Intel Gigabit LAN, Serial ATA3

Intel Skylake-H Processor with Intel® QM170 Chipset PCH-H

The 6th Generation Intel® Core™ H-series processor family is new generation and multi-core processor built on 14 nanometer process.

Skylake provide new HD Graphics 530 support triple displays at the same time, maximum supported is up to 16GB of DDR4, better performance, flexibility and more enhanced security that is suitable for a variety of intelligent systems the ideal choice.

All in One multimedia solution

LE-37I provides high performance onboard graphics, 18/24-bit single/dual channel LVDS interface, DisplayPort, DVI, CRT and High Definition Audio, to meet the requirement of the multimedia application.

Flexible Expansion Interface

It includes two minicard slot, 6 x COM port, 4 x USB3.0, and 4 x USB2.0.

Skylake remove EHCI

When you install WIN7 with USB device(CDROM, Keyboard, Mouse...), Windows7 can not identify your usb device. You can use SATA CD-ROM and PS/2 to install Windows7.

1.2 <Product Specification>

System

Processor	Intel® Skylake Core™ i7, i5, i3 H-series Processor, FCLGA1440 package
Chipset	Intel® QM170 PCH-H
Memory	1 x DDR4 SO-DIMM 2133 MHz up to 16GB, Support Non-ECC, unbuffered memory only
Watchdog Timer	Generates a system reset with internal timer for 1min/s ~ 255min/s
Real Time Clock	Chipset integrated RTC with lithium battery
Expansion	2 x MiniPCle (support mSATA) 1 x Sim slot

Graphics

Chipset	Intel® 9th Gen integrated HD Graphics
Display Interface	1 x DVI, 1 x HDMI, 1 x DisplayPort, 1 x LVDS, 1 x CRT

LAN

Chip	1 x Intel® I219-LM Gigabit PHY LAN (Support iAMT11.0) 1 x Intel® I210-AT Gigabit LAN
------	---

I/O

Serial ATA	2 x SATA3
Audio	Realtek ALC262 HD Audio
Internal I/O	2 x SATA3, 4 x RS232, 4 x USB2.0, 1 x LVDS, 1 x LPC, 1 x PS/2 1 x LCD inverter, 1 x GPIO, 1 x Audio, 1 x SMBUS, 1 x CRT, 1 x DVI 1 x RS232/422/485
Rear I/O	1 x HDMI, 1 x DisplayPort, 4 x USB3.0, 2 x LAN, 1 x RS232

Mechanical & Environmental

Power Requirement	DC 9~24V
Size & Thickness	146mm x 101mm (L x W), 1.6mm
Temperature	Operating within 0°C~60°C (32°F~140°F) Storage within -20°C~80°C (-4°F~176°F)
Relative Humidity	10%~90%, non-condensing

1.3 <Block Diagram>

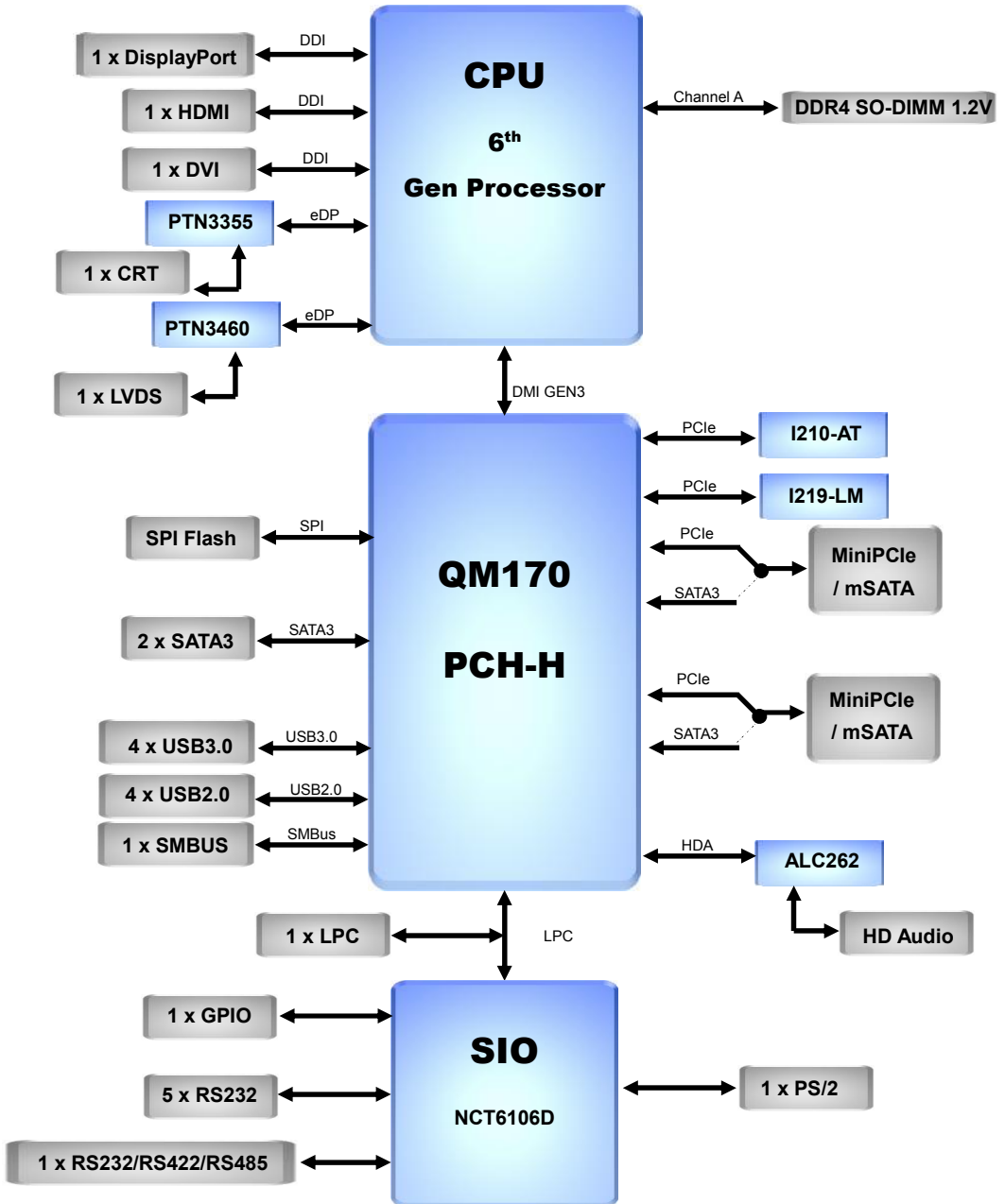

Chapter 2 <Hardware setup>

2.1 <Connector Location and Reference>

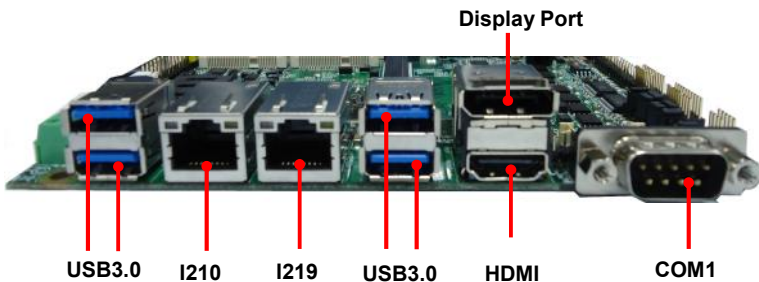
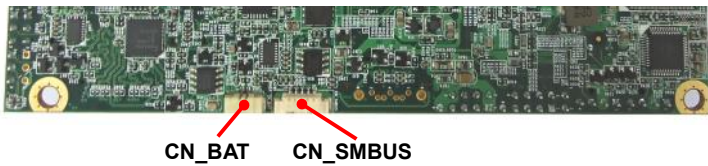
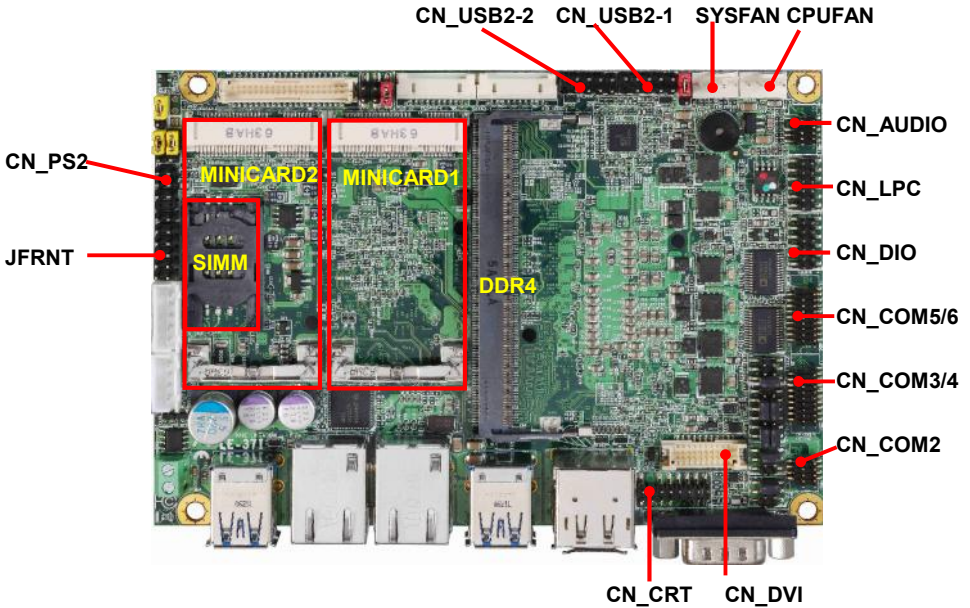

2.1.1 <Internal connectors list>

Connector	Function
DDR4	260-pin DDR4 SO-DIMM slot
SATA3-1/2	10-pin Serial ATA3 connector
CN_AUDIO	5 x 2-pin audio pin header
CN_LPC	6 x 2-pin LPC pin header
CN_LVDS	20 x 2-pin LVDS connector
CN_INV	5-pin LCD inverter connector
CN_SMBUS	5-pin SMBus connector
CN_COM2	20-pin RS232/485/422 for COM2
CN_COM3/4 / 5/6	20-pin RS232 connector
CN_USB 2-1 / 2-2	5 x 2-pin USB2.0 pin header
CN_DIO	6 x 2-pin digital I/O connector
CN_CRT	16-pin VGA connector
CN_BAT	2-pin Battery connector
CN_DVI	10 x 2-pin DVI connector
CPUFAN	4-pin CPU fan connector
SYSFAN	4-pin system fan connector
JFRNT	10-pin front panel switch/indicator connector
MINI_CARD1	52-pin MiniPCIe card slot (support MSATA by JMSATA1)
MINI_CARD2	52-pin MiniPCIe card slot (support MSATA by JMSATA2)
DC_IN	2-pin power input Terminal Block
SIMM	6-pin socket

2.1.2 <External connectors list>

Connector	Function
DisplayPort	DisplayPort connector
HDMI	HDMI connector
RJ45-1/2	RJ45 connector
USB3.0 1/2	USB3.0 connector
COM1	DB9 Serial port connector

2.2 <Memory Setup>

In the process, the board must be powered off.

1. Put the memory tilt into the slot. Note the Memory notch key aligned slot key.
2. Then press down till lock into the mounting notch.

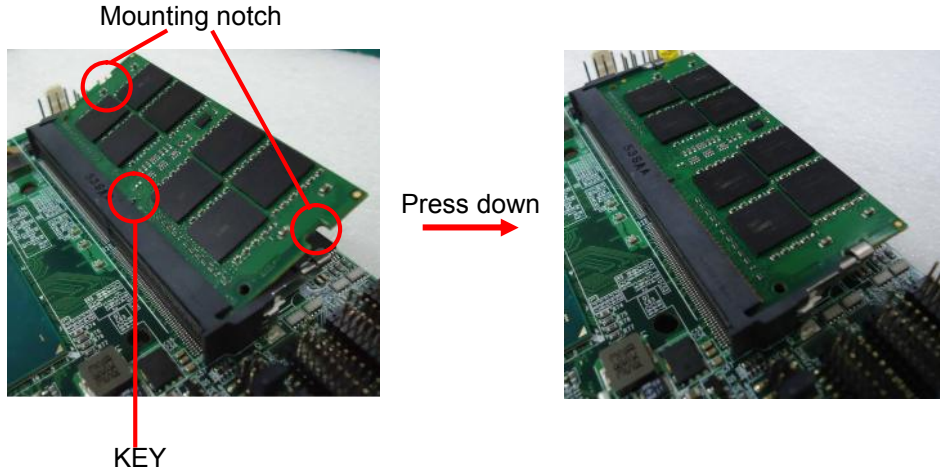

3. To remove the memory, push outward on both sides of the latch.

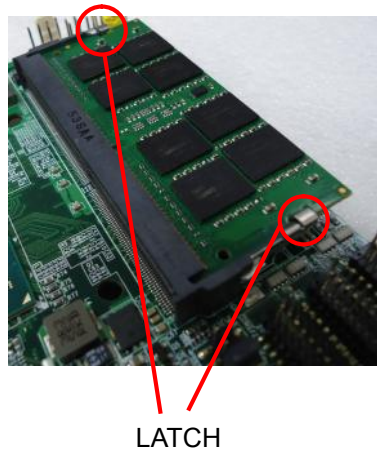

2.3 <Jumper Location and Reference>

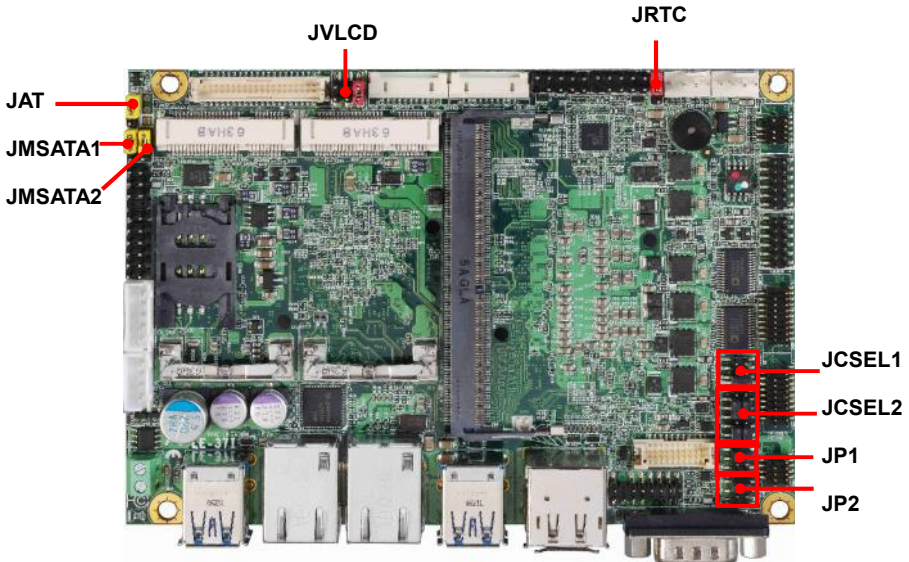

2.3.1 <Jumper list>

Jumper	Function
JAT	Power mode select
JRTC	CMOS Normal/Clear Setting
JVLCD	Panel Voltage Setting
JMSATA1	MiniCard 1 MSATA Setting
JMSATA2	MiniCard 2 MSATA Setting
JP1	COM1 Voltage Setting (For Pin 9)
JP2	COM2 Voltage Setting (For Pin 9)
JCSEL1	COM2 RS-232 RS422 RS485 Setting
JCSEL2	COM2 RS-232 RS422 RS485 Setting

2.3.2 <Clear CMOS and Power on type selection>

The board's data of CMOS can be setting in BIOS. If the board refuses to boot due to inappropriate CMOS settings, here is how to proceed to clear (reset) the CMOS to its default values.

JAT: AT/ATX mode select jumper

Jumper settings	Function
1-2	AT mode
2-3	ATX mode (Default)

JRTC: Clear CMOS data jumper

Jumper settings	Function
1-2	Clear CMOS
2-3	Normal (Default)

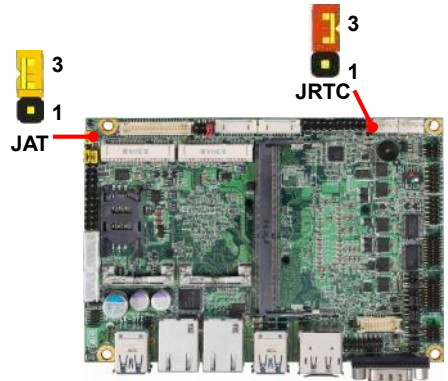

2.4 <I/O interface>

2.4.1 <Serial ATA interface>

CN_SATA3-1/2: SATA3 10-pin connector

Pin	Signal
1	GND
2	TX+
3	TX-
4	GND
5	NA
6	NA
7	GND
8	RX-
9	RX+
10	GND

CN_SATA3-2 CN_SATA3-1

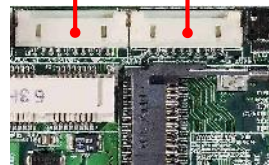

10 1
CN_SATA3-1/2

2.4.2 <Ethernet interface>

The board provide I219-LM PHY Gigabit Ethernet and I210-AT Gigabit Ethernet on rear I/O. Intel I219-LM and I210 supports operation at 10/100/1000 Mb/s data rates, with IEEE802.3 compliance and Wake-On-LAN supported.

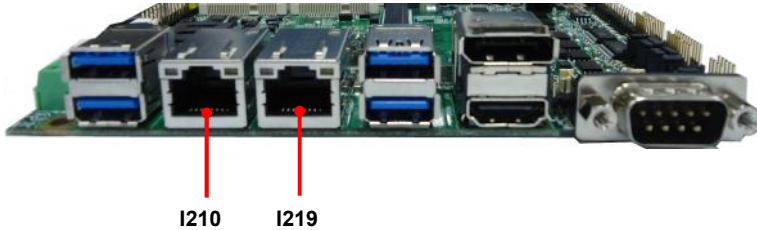

2.4.3 <Display interface>

Based on the 6th Gen CPU with built-in HD Graphics 530, CRT and DVI up to **1920x1080@60Hz**, DisplayPort up to **4096x2304@60Hz**. About the internal Display, LVDS (PTN3460) up to **1920x1200@60Hz** support 18/24-bit color depth and single/dual channel. About select LCD Panel Type in BIOS, please refer **Appendix B**.

The built-in HD Graphics support triple display function with clone mode and extended mode.

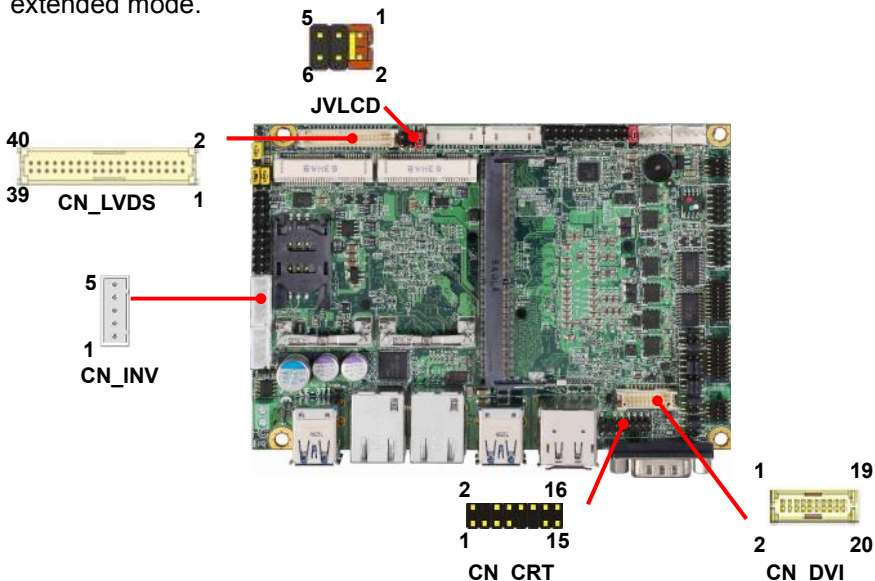

CN_CRT: CRT 16-pin connector (Pitch 2.00 mm)

Pin	Signal	Pin	Signal
1	BR	2	BG
3	BB	4	NC
5	IOGND1	6	IOGND1
7	IOGND1	8	IOGND1
9	NC	10	IOGND1
11	NC	12	5VCCA
13	5HSYNC	14	5VSYNC
15	5VCLK	16	NC

CN_LVDS: LVDS 40-pin connector (Model: HIROSE DF13-40DP-1.25V compatible)

Pin	Signal	Pin	Signal
1	Set by JVLCD	2	Set by JVLCD
3	GND	4	Detect (Active low)
5	B_LVDS_0-	6	A_LVDS_0-
7	B_LVDS_0+	8	A_LVDS_0+
9	GND	10	GND
11	B_LVDS_1-	12	A_LVDS_1-
13	B_LVDS_1+	14	A_LVDS_1+
15	GND	16	GND
17	B_LVDS_2-	18	A_LVDS_2-
19	B_LVDS_2+	20	A_LVDS_2+
21	GND	22	GND
23	B_LVDS_3-	24	A_LVDS_CLK-
25	B_LVDS_3+	26	A_LVDS_CLK+
27	GND	28	GND
29	B_LVDS_CLK-	30	A_LVDS_3-
31	B_LVDS_CLK+	32	A_LVDS_3+
33	GND	34	GND
35	NC	36	LVDS_DDCSCL
37	NC	38	LVDS_DDCSDA
39	NC	40	NC

Note: Pin4 only need to be connected to GND

CN_INV: LVDS 5-pin Backlight power connector

Pin	Signal
1	12V
2	Backlight Control
3	GND
4	GND
5	Enable Backlight

JVLCD: LVDS panel power select jumper

Jumper settings	Function
1-2	3.3V (Default)
2-3	5V
5-6	12V

CN_DVI: DVI onboard 20-pin connector

Pin	Signal	Pin	Signal
1	+5V	2	N/C
3	HPD	4	Ground
5	TMDSTX0N	6	TMDSTX0P
7	Ground	8	TMDSTX1N
9	TMDSTX1P	10	Ground
11	TMDSTX2N	12	TMDSTX2P
13	Ground	14	Ground
15	TMDSTXCP	16	Ground
17	DVI_DA	18	DVI_SL
19	N/C	20	N/C

2.4.4 <Serial Port interface>

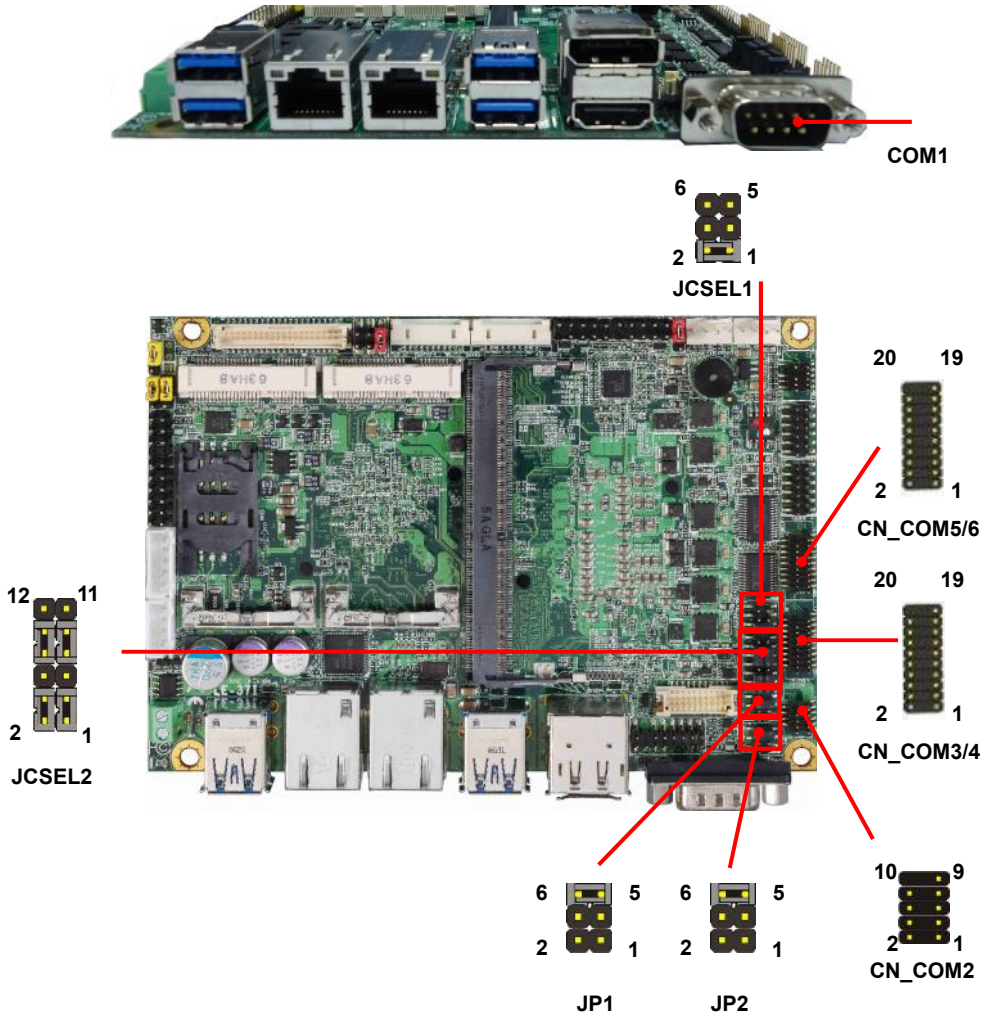

COM1: RS232 DB9 connector

Pin	Signal	Pin	Signal
1	DCD	2	RXD
3	TXD	4	DTR
5	GND	6	DSR
7	RTS	8	CTS
9	Set by JP1	10	Key

CN_COM2: RS232/422/485 10-pin header (Pitch 2.54 x 1.27mm)

Pin	Signal	Pin	Signal
1	DCD/ 422TX-/ 485-	2	RXD/ 422TX+/ 485+
3	TXD/ 422RX+	4	DTR/ 422RX-
5	GND	6	DSR
7	RTS	8	CTS
9	Set by JP2	10	Key

Note: Use JCSEL1 and JCSEL2 to select communication mode

COM3/4: COM 20-pin header (Pitch 2.54 x 1.27mm)

Pin	Signal	Pin	Signal
1	DCD1	2	RXD1
3	TXD1	4	DTR1
5	GND	6	DSR1
7	RTS1	8	CTS1
9	RI1	10	NC
11	DCD2	12	RXD2
13	TXD2	14	DTR2
15	GND	16	DSR2
17	RTS2	18	CTS2
19	RI2	20	Key

COM5/6: COM 20-pin header (Pitch 2.54 x 1.27mm)

Pin	Signal	Pin	Signal
1	DCD1	2	RXD1
3	TXD1	4	DTR1
5	GND	6	DSR1
7	RTS1	8	CTS1
9	RI1	10	NC
11	DCD2	12	RXD2
13	TXD2	14	DTR2
15	GND	16	DSR2
17	RTS2	18	CTS2
19	RI2	20	Key



JP1, JP2: COM1, COM2 pin-9 setting

Jumper settings	Function
1-2	5V
3-4	12V
5-6	RI (Default)

Effective patterns of connection: 1-2 / 3-4 / 5-6

Other may cause damage

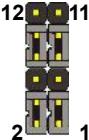
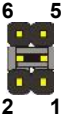
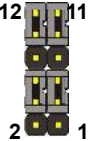
JCSEL1, JCSEL2: For configure COM2 communication mode

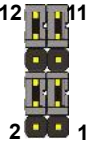
Function	JCSEL1	JCSEL2
RS232 (Default)		
RS485		
RS422		

2.4.5 <USB interface>

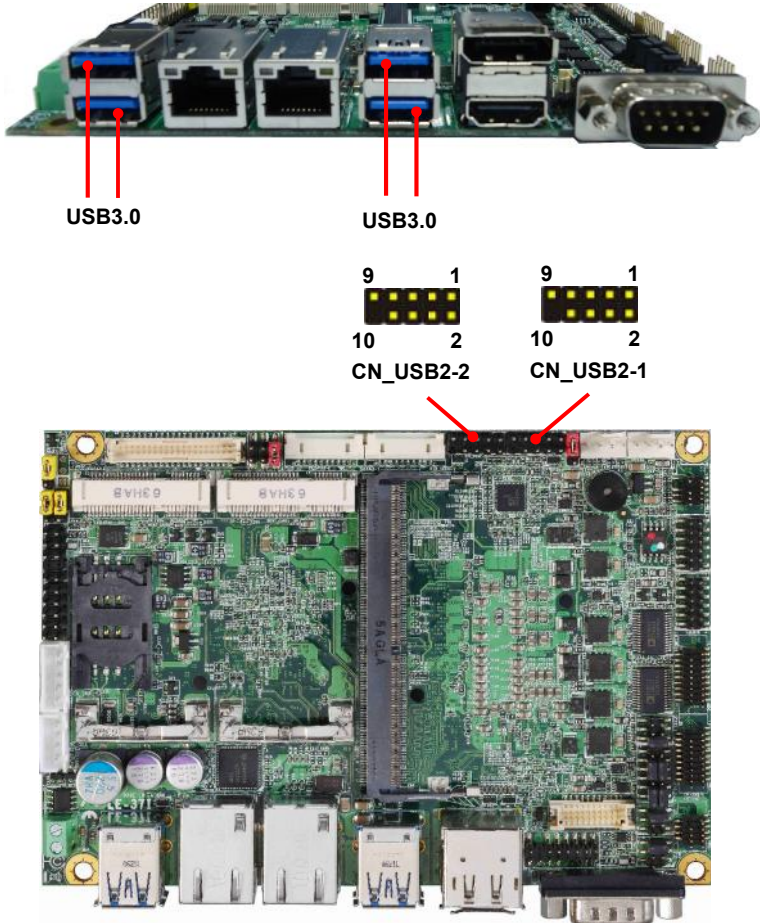

CN_USB 2-1/2-2: USB2.0 10-pin header (Pitch 2.54 mm)

Pin	Signal	Pin	Signal
1	5VSB	2	5VSB
3	DATA0-	4	DATA1-
5	DATA0+	6	DATA1+
7	GND	8	GND
9	GND	10	Key

2.4.6 <Audio interface>



CN_AUDIO: Front panel audio 10-pin header (Pitch 1.27mm x 2.54mm)

Pin	Signal	Pin	Signal
1	MIC_L	2	GND
3	MIC_R	4	NC
5	FP_OUT_R	6	MIC_DETECT
7	SENSE	8	Key
9	FP_OUT_L	10	FP_OUT_DETECT

2.4.7 <Expansion slot>

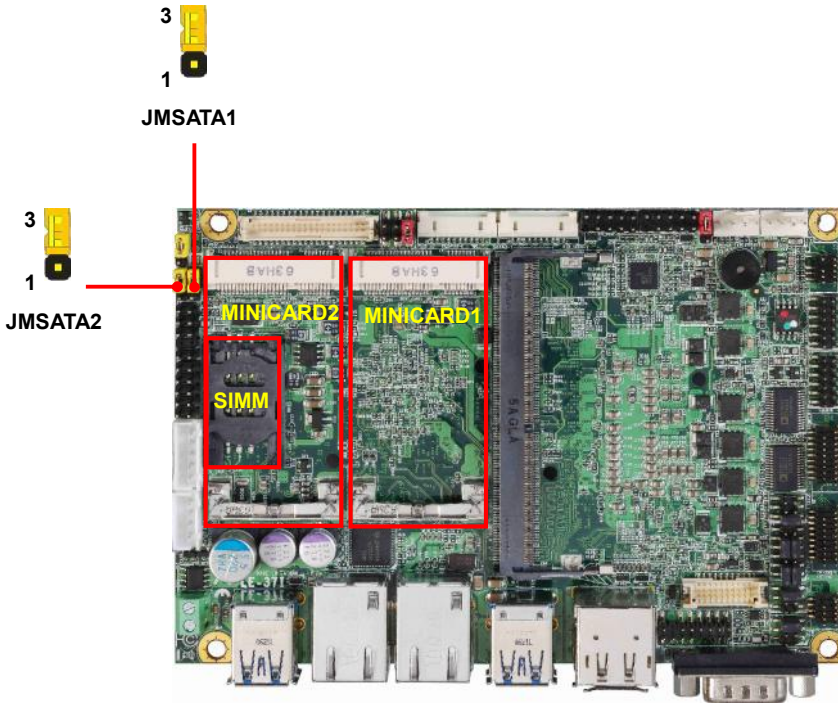

MINI_CARD1 and MINI_CARD2 have some special design to compatible our mini-PCIe card. (ex: MPX-574D2, MPX-210D2 etc)

MINI_CARD2 support mSATA by JMSATA, and connect SIM card with 3G module.

JMSATA1/2: Setting MINI_CARD2 to support PCIe/mSATA

Jumper settings	Function
1-2	Support mSATA
2-3	Normal operation (Default)

2.4.8 <Front panel switch and indicator>

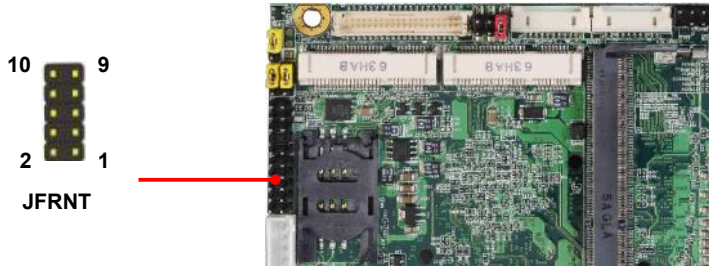

JFRNT: Front panel switch and indicator 14-pin header (Pitch 2.54mm)

Pin	Signal	Pin	Signal
1	Power_ON-	2	Power_ON+
3	Speaker-	4	Speaker+
5	HDD_LED-	6	HDD_LED+
7	Power_LED-	8	Power_LED+
9	Reset+	10	Reset-

2.4.9 <GPIO and Other interface>

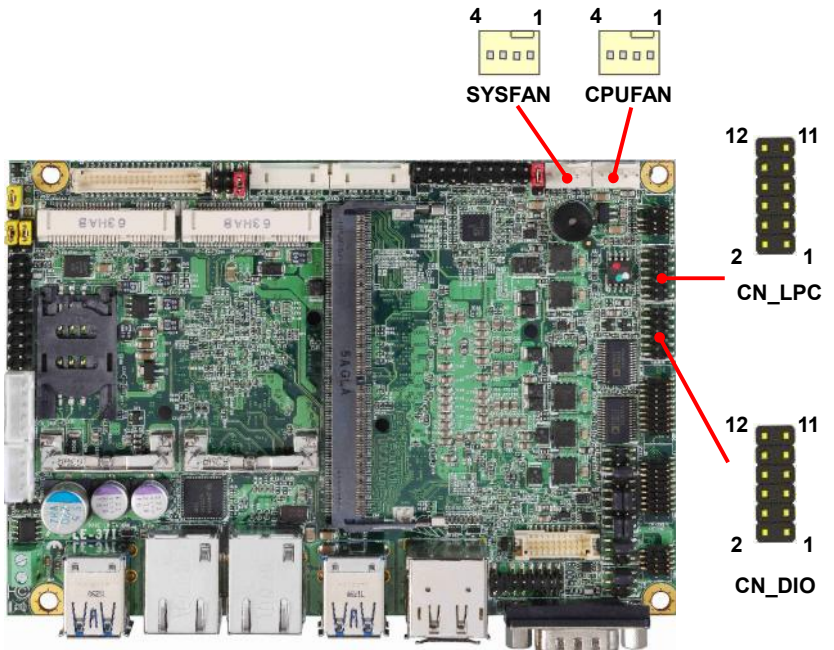

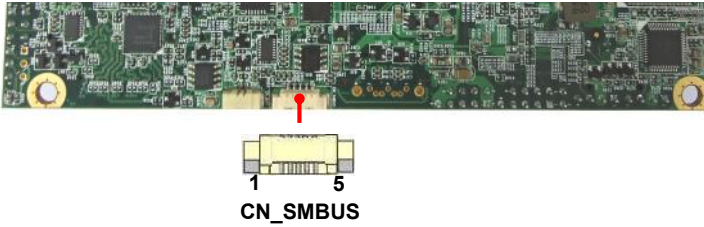

When using GPIO function, please note:

As Output: **Open-drain**, most applications **need use an external pull up resistor.** (If not may cause damage)

As Input: **TTL-level.**

GPIO DC characteristics

Parameter	SYM	MIN	TYP	MAX	UNIT	Conditions
Input Low Voltage	V_{IL}			0.8	V	
Input High Voltage	V_{IH}	2.0			V	
Output Low Voltage	V_{OL}			0.4	V	$I_{OL} = 12\text{mA}$
Input High Leakage	I_{LH}			+10	μA	$V_{IN} = 3.3\text{V}$
Input Low Leakage	I_{LL}			-10	μA	$V_{IN} = 0\text{V}$

CN_DIO: GPIO 12-pin header (Pitch 2.00mm)

Pin	Signal	Pin	Signal
1	GND	2	GND
3	GPIO0	4	GPIO4
5	GPIO1	6	GPIO5
7	GPIO2	8	GPIO6
9	GPIO3	10	GPIO7
11	5V	12	12V

CN_LPC: LPC 12-pin header (Pitch 2.00mm)

Pin	Signal	Pin	Signal
1	CLK	2	RST
3	-LFRAME	4	LAD3
5	LAD2	6	LAD1
7	LAD0	8	3.3V
9	SERIRQ	10	GND
11	3.3VSB	12	NC

CN_SMBUS: SMBus 5-pin connector

Pin	Signal
1	5V
2	NC
3	SMBDAT
4	SMBCLK
5	GND

CPUFAN: CPU cooler fan 4-pin connector

Pin	1	2	3	4
Signal	GND	12V	Sensor	Control

SYSFAN: System cooler fan 4-pin connector

Pin	1	2	3	4
Signal	GND	12V	Sensor	Control

2.5 <Power supply>

2.5.1 <Power input>

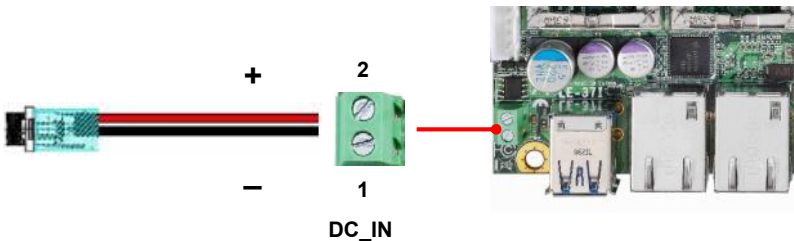

DC_IN: Terminal Block 2-pin power connector

Pin	Signal	Pin	Signal
1	GND	2	Power in

The power support 9~24V wide voltage input.

2.5.2 <Power output>

DC_OUT: SATA power 4-pin connector

Pin	Signal
1	12V
2	GND
3	GND
4	5V

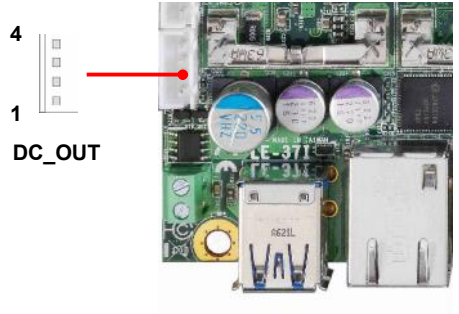

Appendix A <Flash BIOS>

A.1 <Flash tool>

The board is based on Phoenix BIOS and can be updated easily by the BIOS auto flash tool. You can download the tool online at the address below:

[FPT TOOL](#)

The tool's file name is "fpt.exe", it's the utility that can write the data into the BIOS flash chip and update the BIOS.

A.2 <Flash BIOS process>

1. Please make a bootable UFD which can boot into DOS environment.
2. Unzip the flash tool and copy it into bootable UFD.
3. Add a bin file to the same folder..
4. Power on the system and flash the BIOS under the DOS environment.

(Command: fpt -savemac -f xxx.bin)

5. Power off the system and then power on.

Appendix B <LCD Panel Type select>

According your panel, it need to select the correct resolution in the BIOS. If there is no fit your panel type, please feedback for us to make OEM modol.

You can find the setting from

[Advanced] → [Intel Advanced Menu]

→ [SA configuration] → [Graphics confuguration] → [LCD control]

→ [LCD Panel Type]

Phoenix SecureCore Technology Setup

Advanced

Intel Advanced Menu	Item Specific Help								
<pre> PCI Subsystem Settings ACPI Settings CPU Configuration Power & Performance System Agent (SA) Configuration PCB-IO Configuration Manageability Application Configuration Super IO Chip </pre>	<pre> System Agent (SA) Parameters </pre>								
<table style="width: 100%; border: none;"> <tr> <td style="width: 15%;">F1 Help</td> <td style="width: 15%;">Select Item +/-</td> <td style="width: 15%;">Change Values</td> <td style="width: 15%;">F9 Setup Defaults</td> </tr> <tr> <td>Esc Exit <></td> <td>Select Menu Enter</td> <td>Select Sub-Menu</td> <td>F10 Save and Exit</td> </tr> </table>		F1 Help	Select Item +/-	Change Values	F9 Setup Defaults	Esc Exit <>	Select Menu Enter	Select Sub-Menu	F10 Save and Exit
F1 Help	Select Item +/-	Change Values	F9 Setup Defaults						
Esc Exit <>	Select Menu Enter	Select Sub-Menu	F10 Save and Exit						

Phoenix SecureCore Technology Setup

Advanced

Graphics Configuration	Item Specific Help								
<pre> Internal Graphics [Auto] GTI Size [8MB] Aperture Size [256MB] DUMT Pre-Allocated [32M] DUMT Total Gfx Mem [256M] Gfx Low Power Mode [Enabled] UDD Enable [Enabled] HDCP Support [Enabled] Algorithm [One-time] PM Support [Enabled] PAUP Enable [Enabled] Cd Clock Frequency [675 Mhz] IUER Button Enable [Disabled] LCD Control Intel(R) Ultrabook Event Support </pre>	<pre> LCD Control </pre>								
<table style="width: 100%; border: none;"> <tr> <td style="width: 15%;">F1 Help</td> <td style="width: 15%;">Select Item +/-</td> <td style="width: 15%;">Change Values</td> <td style="width: 15%;">F9 Setup Defaults</td> </tr> <tr> <td>Esc Exit <></td> <td>Select Menu Enter</td> <td>Select Sub-Menu</td> <td>F10 Save and Exit</td> </tr> </table>		F1 Help	Select Item +/-	Change Values	F9 Setup Defaults	Esc Exit <>	Select Menu Enter	Select Sub-Menu	F10 Save and Exit
F1 Help	Select Item +/-	Change Values	F9 Setup Defaults						
Esc Exit <>	Select Menu Enter	Select Sub-Menu	F10 Save and Exit						

BIOS panel type selection form (BIOS Version:1.0)			
Single / Dual channel		Single / Dual channel	
NO.	Type	NO.	Type
1	VBIOS DEFAULT	9	1366 x 768
2	640 x 480	10	1680 x 1050
3	800 x 600	11	1920 x 1200
4	1024 x 768	12	1400 x 900
5	1280 x 1024	13	1600 x 900
6	1400 x 1050 Reduced Blanking	14	1024 x 768
7	1400 x 1050 non-Reduced Blanking	15	1280 x 800
8	1600 x 1200	16	1920 x 1080
		17	OEM

Appendix C <Programmable Watch Dog Timer>

The watchdog timer makes the system auto-reset while it stops to work for a period. The integrated watchdog timer can be setup as system reset mode by program. You can select Timer setting in the BIOS, after setting the time options, the system will reset according to the period of your selection.

Find the setting from

[Advanced] → [Intel Advanced Menu] → [Super IO Chip]

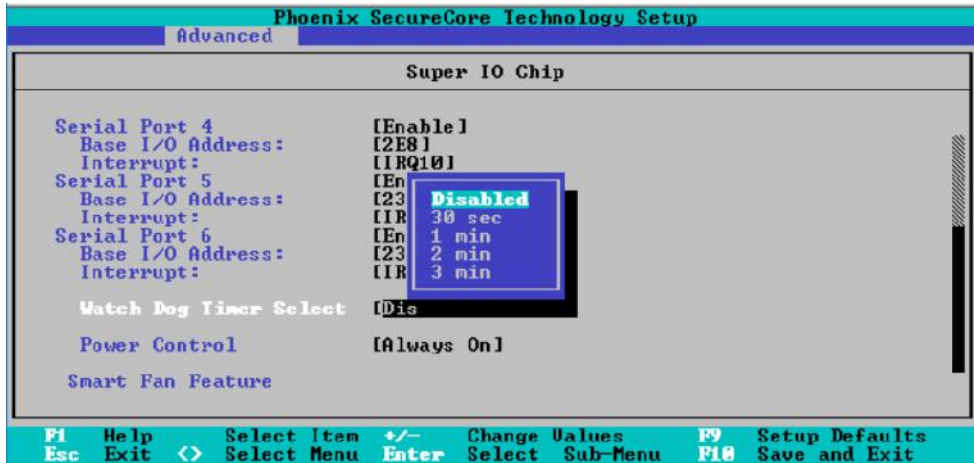

Timeout value range

1 to 255 Minute and Second

Program sample

Watchdog timer setup as system reset with 5 second of timeout

- o 4E 87 ;enter configuration
- o 4E 87
- o 4E 07
- o 4F 08 ;select Logical Device
- o 4E 30

- o 4F 01 ; activate WDTO# function
- o 4E F5
- o 4F 00 ;set "00" is second mode, set "04" is minute mode
- o 4E F6
- o 4F 05 ;00h: Timeout Disable
;01h: Timeout occurs after 1 minute only
;02h: Timeout occurs after 2 second/minute
;03h: Timeout occurs after 3 second/minute
:
;FFh: Timeout occurs after 255 second/minute
(The deviation is approx 1 second.)

For further information, please refer to Nuvoton NCT6106D datasheet

Appendix D <Hardware monitor >

Find the setting from [Misc] → [SIO NCT6106D Hardware Monitor]

Phoenix SecureCore Technology Setup	
Misc	
Hardware Monitor	Item Specific Help
System Temperature	[30.5 C]
CPU Temperature	[29.5 C]
System Fan Speed	[0 RPM]
CPU Fan Speed	[6585 RPM]
AUX Fan Speed	[0 RPM]
Battery 3V (VBAT)	[3.000 V]
CPU UCORE	[1.000 V]
12V	[11.985 V]
5V	[5.000 V]

F1	Help	Select Item	+/-	Change Values	F9	Setup Defaults
Esc	Exit	<>	Select Menu	Enter	Select Sub-Menu	F10 Save and Exit

Appendix E <Programmable GPIO >

The GPIO' can be programmed with the MS-DOS debug program using simple IN/OUT commands.

The DC characteristics please refer to GPIO paragraph (Page20).

GPIO	0	1	2	3	4	5	6	7
bit	0	1	2	3	4	5	6	7

```
-o 4E 87      ;enter configuration
-o 4E 87
-o 4E 07
-o 4F 07      ;select Logical Device
-o 4E 30
-o 4F 10      ;activate GPIO function (The board use GPIO3)
-o 4E F0
-o 4F XX      ;set "01" GPIO as input, set "00" GPIO as output
-o 4E F1
-o 4F XX      ;if set GPIO as output, this register's value can be set "00~ FF"
```

Optional

```
-o 4E F2
-o 4F XX      ;set "01", the respective bit are inverted (Both input and output)
              ;set "00", the respective bit are normal
```

For further information, please refer to Nuvoton NCT6106D datasheet

Appendix F <RAID Setting>

When use RAID function, it need to enter the BIOS set RAID mode first.

[Advanced] → [Intel Advanced Menu] → [PCH-IO Configuration]
→ [SATA Configuration] → [SATA Mode Selection]

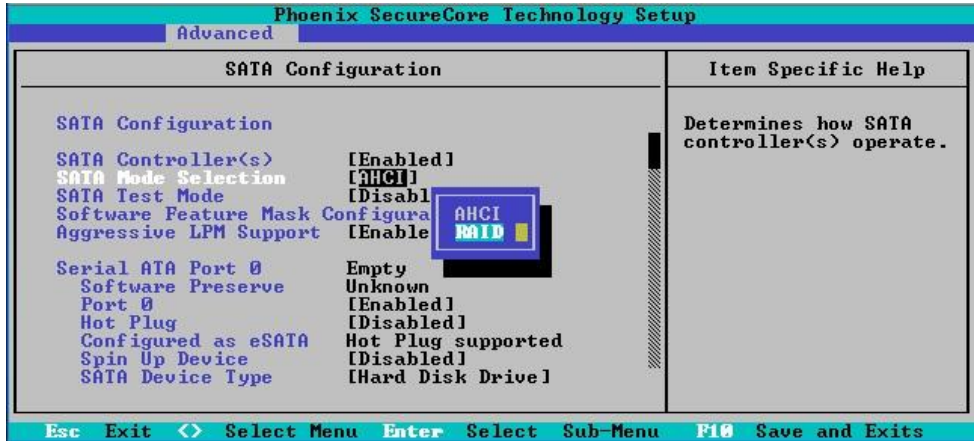

If this screen stop time is too short, it can be set in the BIOS.

[Advanced] → [Intel Advanced Menu] → [PCH-IO Configuration]
→ [SATA Configuration] → [Software Feature Mask Configuration]
→ [OROM UI Normal Delay] → [8 sec] **(Need to set RAID mode first)**

At boot time, press <CTRL + I> to enter the RAID configuration menu.

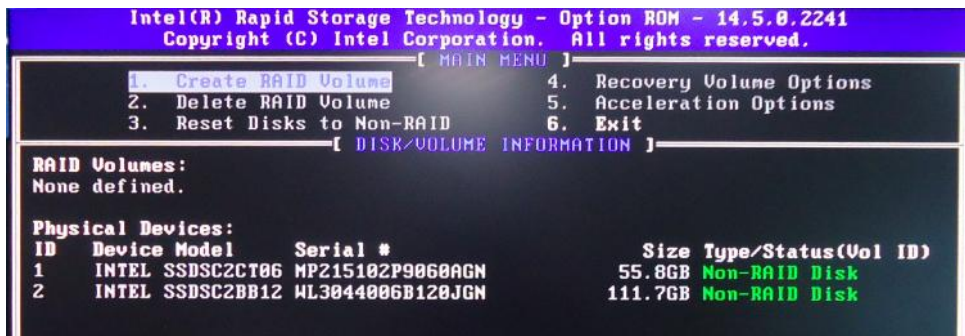

Contact information

Any advice or comment about our products and service, or anything we can help you please don't hesitate to contact with us. We will do our best to support you for your products, projects and business.

Taiwan Commate computer Inc.

Address	19F., NO.94, Sec. 1, Xintai 5 th Rd., Xizhi Dist., New Taipei City 22102, Taiwan.
TEL	+886-2-26963909
FAX	+886-2-26963911
Website	www.commell.com.tw
E-mail	info@commell.com.tw (General information) tech@commell.com.tw (Technical Support)

Commell is a brand name of Taiwan Commate computer Inc.