

LE-37H

3.5 inch Motherboard

User's Manual

Edition 1.0
2017/04/20

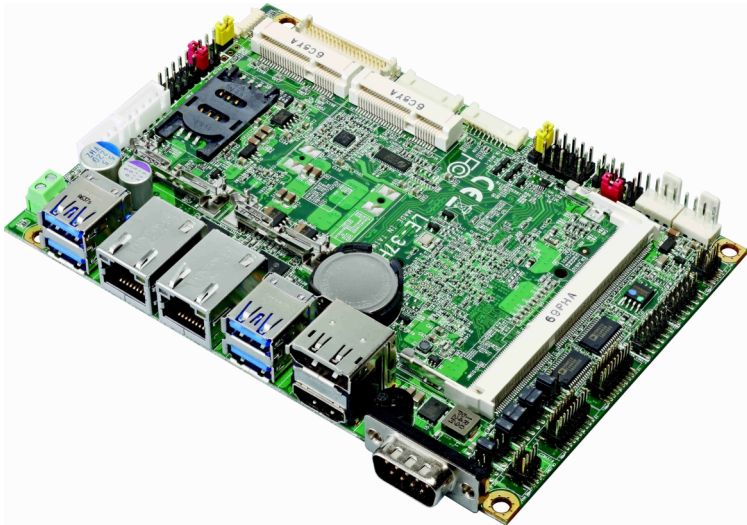

Copyright

Copyright 2017, all rights reserved. This document is copyrighted and all rights are reserved. The information in this document is subject to change without prior notice to make improvements to the products.

This document contains proprietary information and protected by copyright. No part of this document may be reproduced, copied, or translated in any form or any means without prior written permission of the manufacturer.

All trademarks and/or registered trademarks contains in this document are property of their respective owners.

Disclaimer

The company shall not be liable for any incidental or consequential damages resulting from the performance or use of this product.

The company does not issue a warranty of any kind, express or implied, including without limitation implied warranties of merchantability or fitness for a particular purpose.

The company has the right to revise the manual or include changes in the specifications of the product described within it at any time without notice and without obligation to notify any person of such revision or changes.

Trademark

All trademarks are the property of their respective holders.

Any questions please visit our website at <http://www.commell.com.tw>

Packing List:

Please check the package content before you starting using the board.



1 x LE-37H Motherboard
(include heat spreader or Cooler Fan)



1 x SATA CABLE
(OALSATA3-H10-L35 / 1040523)



1 x PS/2 Keyboard & Mouse cable
(OALPS2/KM / 1040131)



1 xDC Input Power Cable
(OALDC-B / 1040513)



1 x Audio cable
(OALPJ-HDUNB / 1040123)



1 x COM Cable
(OALES-BKU1NB / 1040086)



1 x SATA Power Cable
(OALSATA15-2PJ / 1040613)

Optional:

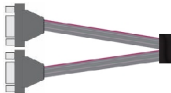

1 x Dual COM cable
(OALES-BKU2NB / 1040090)

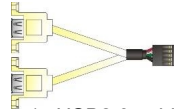

1 xUSB2.0 cable
(OALUSBA-3 / 1040173)



1 x DDR3L SO-DIMM
(DSDM8GB-DDR3L-1600-SO-1.35V / 1140073)

Printed Matters:

Driver CD x 1 (Including User's Manual)

Index

Chapter 1 <Introduction>	4
1.1 <Product Overview>	4
1.2 <Product Specification>	5
1.3 <Block Diagram>	6
Chapter 2 <Hardware setup>	7
2.1 <Connector Location and Reference>	7
2.1.1 <Internal connectors list>	8
2.1.2 <External connectors list>	8
2.2 <Jumper Location and Reference>	9
2.2.1 <Jumper list>	9
2.2.2 <Clear CMOS and Power on type selection>	10
2.3 <Installing the Memory>	10
2.4 <I/O interface>	11
2.4.1 <Serial ATA interface>	11
2.4.2 <Ethernet interface>	12
2.4.3 <Display interface>	12
2.4.4 <Serial Port interface>	14
2.4.5 <USB interface>	16
2.4.6 <Audio interface>	17
2.4.7 <Expansion slot>	18
2.4.8 <Front panel switch and indicator>	19
2.4.9 <Other interface>	19
2.5 <Power supply>	21
2.5.1 <Power input>	21
2.5.2 <Power output>	21
Appendix A <Flash BIOS>	22
A.1 BIOS Auto Flash Tool	22
A.2 Flash Method	22
Appendix B <Setup ADP-3355,ADP-3460>	22
Appendix C <LCD Panel Type select>	23
Appendix D <Programmable Watch Dog Timer>	25
Appendix E <Programmable GPIO >	26
Appendix F <SuperIO Setting>	27
Contact information	28

Chapter 1 <Introduction>

1.1 <Product Overview>

LE-37H is 3.5 inch Motherboard which is design based on Intel® Celeron® Processor N3350, and Intel® Pentium® Processor N4200 (Apollo Lake SoC), delivering outstanding compute, graphical, and media performance while operating in an extended range of thermal conditions. The SoC bases on the Silvermont microarchitecture, utilizing Intel's industry-leading 14nm process technology with 3-D Tri-Gate transistors, which deliver significant improvements in computational performance and energy efficiency.

New features for Apollo Lake

The Intel® Celeron® Processor N3350, and Intel® Pentium® Processor N4200 have a lower TDP 6W, it provides new HD Graphics to support triple display, 4K resolution, maximum memory size is up to 8GB of DDR3L, and more enhanced security that is suitable for a variety of intelligent systems the ideal choice.

All in One multimedia solution

The board provides high performance onboard graphics, 18/24-bit single/dual channel LVDS interface, DisplayPort, HDMI, and High Definition Audio, to meet the very requirement of the multimedia application.

Flexible Expansion Interface

The board provides one MiniPCIe and support mSATA.

Apollo Lake only support Windows10 64bit

So far Intel just support Windows 10 64bit. It may lose some drivers if you use other Windows version.

1.2 <Product Specification>

System

Processor	Intel® Apollo Lake Series Processor N3350/ N4200, FCBGA1296 package
Chipset	Apollo Lake SoC
Memory	1 x DDR3L DIMM 1866 MHz up to 8GB, Support Non-ECC, unbuffered memory only
Watchdog Timer	Generates a system reset with internal timer for 1min/s ~ 255min/s
Real Time Clock	Chipset integrated RTC with onboard lithium battery
Expansion	2 x MiniPCle (Minicard1 support mSATA) 1 x Sim slot, 1 x SD Card slot

Graphics

Chipset	Intel® HD Graphics
Display Interface	1 x LVDS, 1 x HDMI, 1 x DisplayPort (Optional)

LAN

Chip	2 x Intel® I210-AT Gigabit LAN
------	--------------------------------

I/O

Serial ATA	2 x SATA3 (CN_SATA2 cannot use when Minicard1 change to mSATA)
Audio	Realtek ALC262 HD Audio
Internal I/O	2 x SATA3, 4 x RS232, 2 x USB2.0, 1 x LPC 1 x GPIO , 1 x PS/2, 1 x SMBUS, 1 x LVDS, 1 x LCD inverter, 1 x RS232/422/485, 1 x Audio
Rear I/O	4 x USB3.0, 2 x LAN, 1 x HDMI, 1 x DisplayPort (Optional), 1 x RS232.

Mechanical & Environmental

Power Requirement	DC 9~24V
Size & Thickness	146mm x 101mm (L x W), 1.6mm
Temperature	Operating within 0°C~60°C (32°F~140°F) Storage within -20°C~80°C (-4°F~176°F)
Relative Humidity	10%~90%, non-condensing

1.3 <Block Diagram>

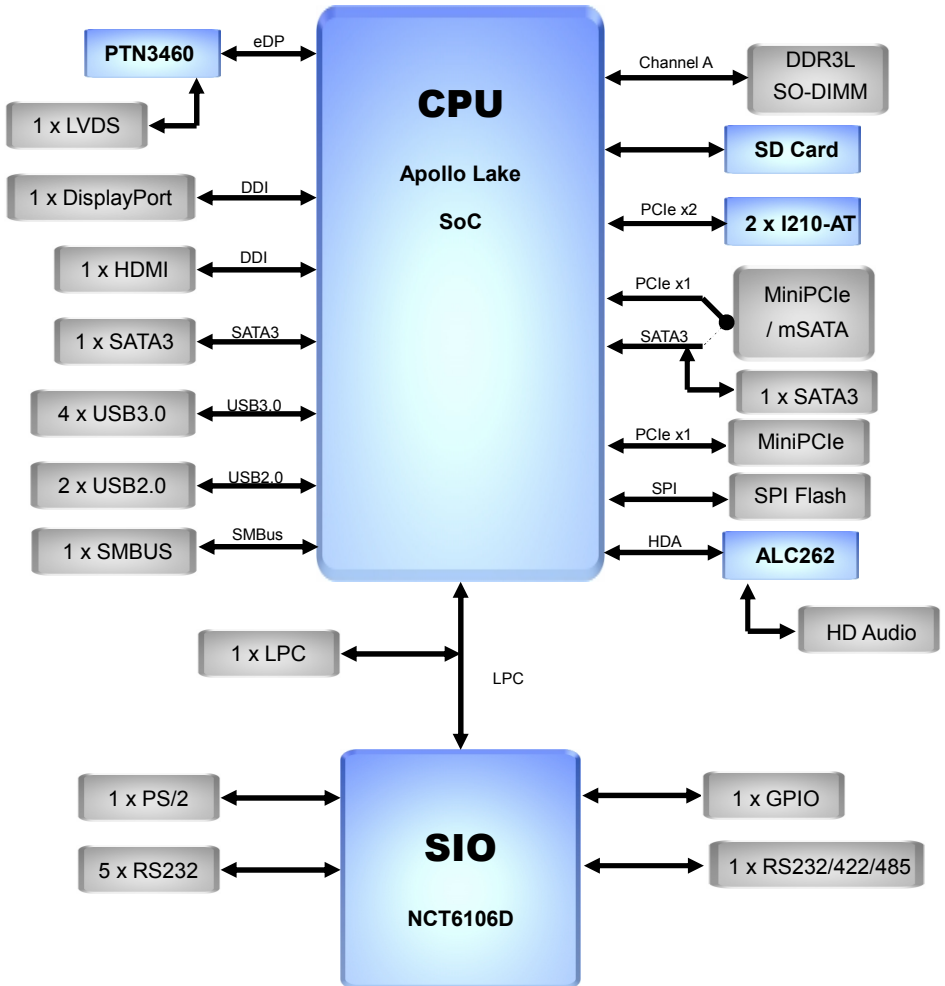

Chapter 2 <Hardware setup>

2.1 <Connector Location and Reference>

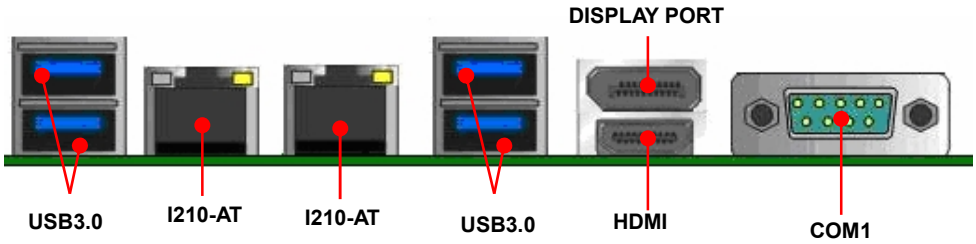
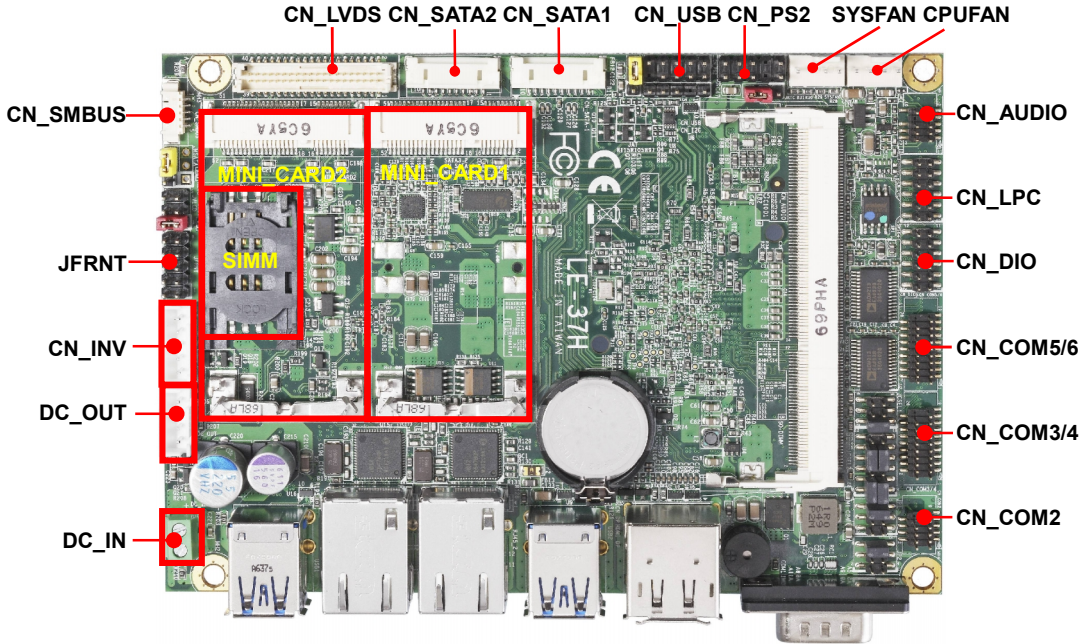

2.1.1 <Internal connectors list>

Connector	Function
SO-DIMM	204-pin DDR3L SO-DIMM slot
CN_SATA-1/2	10-pin Serial ATA3 connector
CN_AUDIO	5 x 2-pin audio pin header
CN_LPC	6 x 2-pin LPC pin header
CN_DIO	6 x 2-pin digital I/O connector
CN_LVDS	20 x 2-pin LVDS connector
CN_INV	5-pin LCD inverter connector
CN_SMBUS	5-pin SMBus connector
CN_COM2	9-pin RS232/485/422 connector
CN_COM 3/4 5/6	19-pin RS232 connector
CN_USB	5 x 2-pin USB2.0 pin header
CN_PS2	5 x 2-pin PS/2 pin header
CPUFAN	4-pin CPU fan connector
SYSFAN	4-pin system fan connector
JFRNT	5 x 2-pin front panel switch/indicator pin header
MINI_CARD1/2	52-pin MiniPCIe card slot
SIMM	6-pin slot
DC_OUT	4-pin SATA Power connector
DC_IN	2-pin power input Terminal Block

2.1.2 <External connectors list>

Connector	Function
DisplayPort	DisplayPort connector
HDMI	HDMI connector
USB1/2	4 x USB3.0 connector
RJ45_1/2	RJ45 LAN connector
COM1	DB9 Serial port connector

2.2 <Jumper Location and Reference>

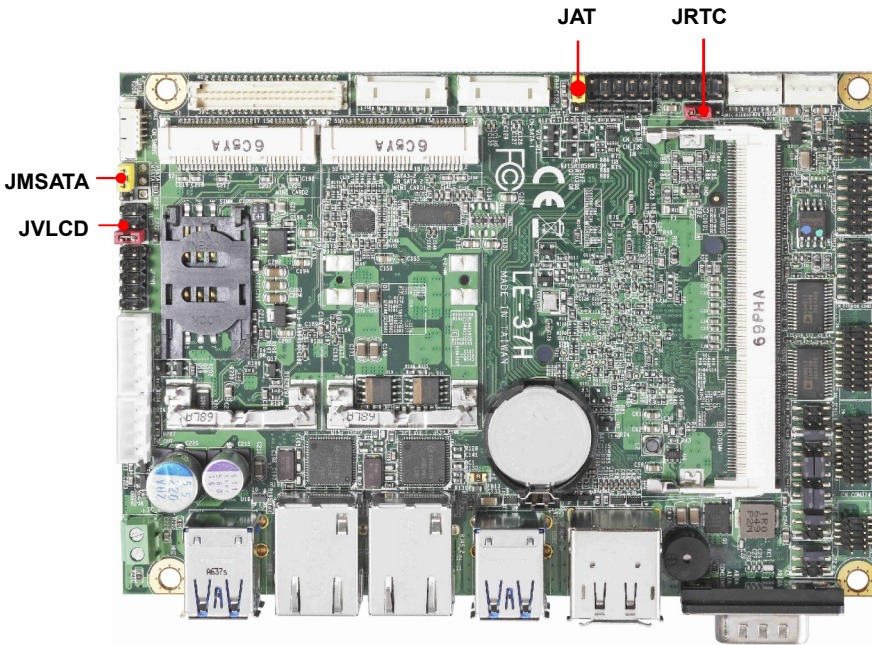

2.2.1 <Jumper list>

Jumper	Function
JAT	Power mode select
JRTC	CMOS Normal/Clear Setting
JVLCD	Panel Voltage Setting
JMSATA	MiniCard mSATA Setting

2.2.2 <Clear CMOS and Power on type selection>

JRTC: Clear CMOS data jumper

Jumper settings	Function
1-2	Clear CMOS
2-3	Normal (Default)

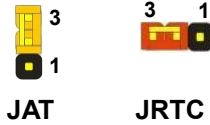

JAT: AT/ATX mode select jumper

Jumper settings	Function
1-2	AT mode
2-3	ATX mode (Default)

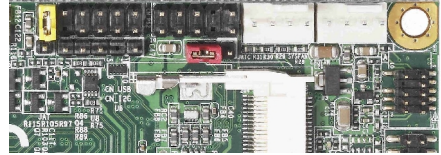

2.3 <Installing the Memory>

In the process, the board must be powered off.

1. Put the memory tilt into the slot. Note the Memory notch key aligned slot key.
2. Then press down till lock into the mounting notch.

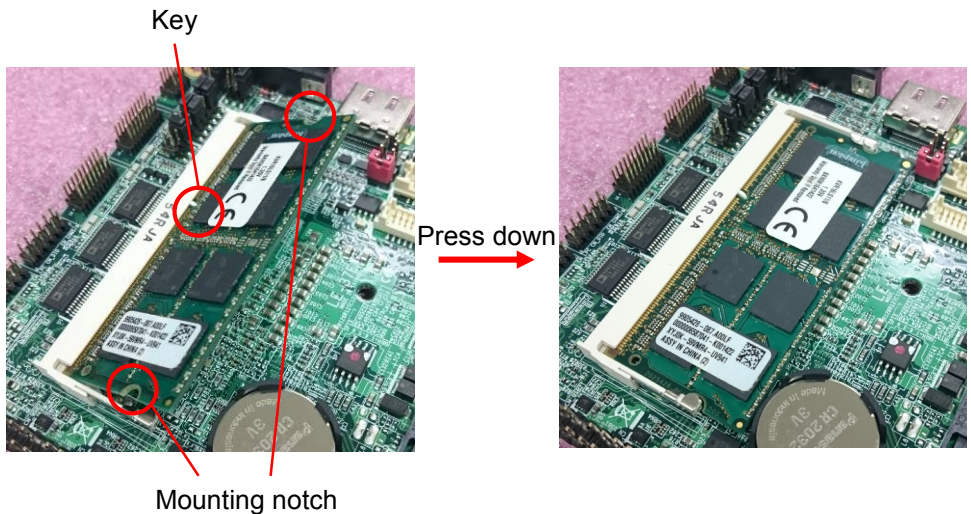

- To remove the memory, push outward on both sides of the latch.

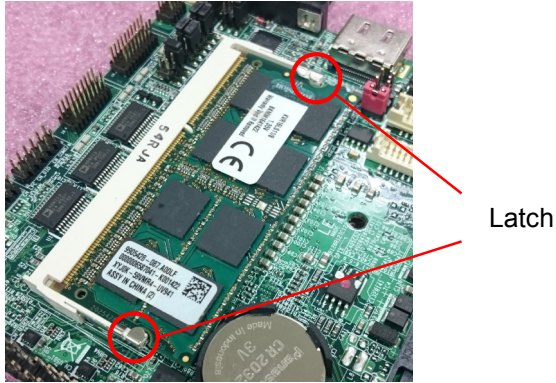

2.4 <I/O interface>

2.4.1 <Serial ATA interface>

CN_SATA: SATA3 10-pin connector

Pin	Signal
1	GND
2	TX+
3	TX-
4	GND
5	NC
6	NC
7	GND
8	RX-
9	RX+
10	GND

CN_SATA1 CN_SATA2

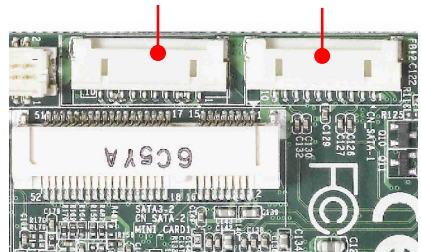

CN_SATA1/2



2.4.2 <Ethernet interface>

The board provide I210-AT Gigabit Ethernet which supports WOL on rear I/O.

Find the setting from

Front Page→Setup utility→

Advanced→South Cluster Configuration→ Miscellaneous Confuguration→

Wake on LAN [Disable] (default)

(You have to turn off fast startup in Windows10)

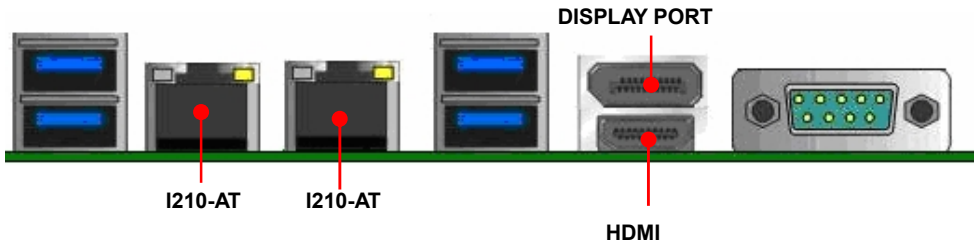

2.4.3 <Display interface>

Based on the Apollo Lake SoC with built-in HD Graphics, the DisplayPort1.2 up to **4096x2160 @ 60Hz** on rear I/O.About the internal Display, the HDMI1.4b resolution up to **3840x2160 @ 30Hz** and LVDS (PTN3460) up to **1920x1200 @ 60Hz** support 18/24-bit color depth and single/dual channel. About select LCD Panel Type in BIOS, please refer **Appendix C**.The built-in HD Graphics support triple display function with clone mode and extended mode.

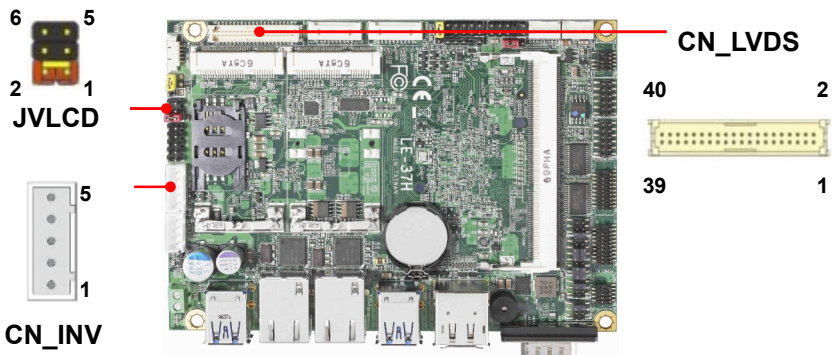

JVLCD: LVDS panel power select jumper

Jumper settings	Function
1-2	3.3V (Default)
2-3	5V
5-6	12V

Effective patterns of connection: 1-2 / 3-4 / 5-6

Other may cause damage

CN_LVDS: LVDS 40-pin connector (Model: HIROSE DF13-40DP-1.25V compatible)

Pin	Signal	Pin	Signal
1	Set by JVLCD	2	Set by JVLCD
3	GND	4	Detect (Active low)
5	B_LVDS_0-	6	A_LVDS_0-
7	B_LVDS_0+	8	A_LVDS_0+
9	GND	10	GND
11	B_LVDS_1-	12	A_LVDS_1-
13	B_LVDS_1+	14	A_LVDS_1+
15	GND	16	GND
17	B_LVDS_2-	18	A_LVDS_2-
19	B_LVDS_2+	20	A_LVDS_2+
21	GND	22	GND
23	B_LVDS_3-	24	A_LVDS_CLK-
25	B_LVDS_3+	26	A_LVDS_CLK+
27	GND	28	GND
29	B_LVDS_CLK-	30	A_LVDS_3-
31	B_LVDS_CLK+	32	A_LVDS_3+
33	GND	34	GND
35	NC	36	LVDS_DDCSCL
37	NC	38	LVDS_DDCSDA
39	NC	40	NC

Pn4 only need to be connected to GND

CN_INV: LVDS 5-pin Backlight power connector

Pin	Signal
1	12V
2	Backlight Control
3	GND
4	GND
5	Enable Backlight

2.4.4 <Serial Port interface>

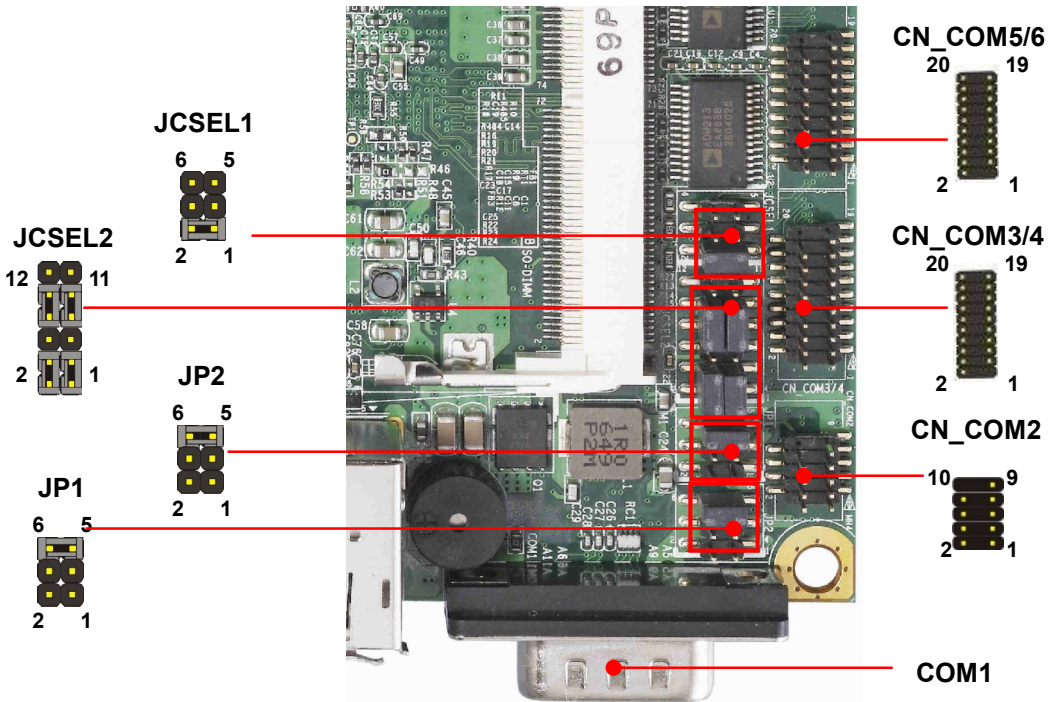

COM1: RS232 DB9 connector

Pin	Signal	Pin	Signal
1	DCD	2	RXD
3	TXD	4	DTR
5	GND	6	DSR
7	RTS	8	CTS
9	Set by JP1	10	Key

CN_COM2: RS232/422/485 10-pin header (Pitch 1.27mm x 2.54mm)

Pin	Signal	Pin	Signal
1	DCD/ 422TX-/ 485-	2	RXD/ 422TX+/ 485+
3	TXD/ 422RX+	4	DTR/ 422RX-
5	GND	6	DSR
7	RTS	8	CTS
9	Set by JP2	10	Key

Note: Use JCSEL1 and JCSEL2 to select communication mode

CN_COM3/4,5/6: RS232 20-pin header (Pitch 1.27mm x 2.54mm)

Pin	Signal	Pin	Signal
1	DCD1	2	RXD1
3	TXD1	4	DTR1
5	GND	6	DSR1
7	RTS1	8	CTS1
9	RI1	10	NC
11	DCD2	12	RXD2
13	TXD2	14	DTR2
15	GND	16	DSR2
17	RTS2	18	CTS2
19	RI2	20	Key

JP1, JP2: COM1, COM2 pin-9 setting

Jumper settings	Function
1-2	5V
3-4	12V
5-6	RI (Default)

Effective patterns of connection: 1-2 / 3-4 / 5-6

Other may cause damage

JCSEL1, JCSEL2: For configure COM2 communication mode

Function	JCSEL1	JCSEL2
RS232		
RS485		
RS422		

2.4.5 <USB interface>

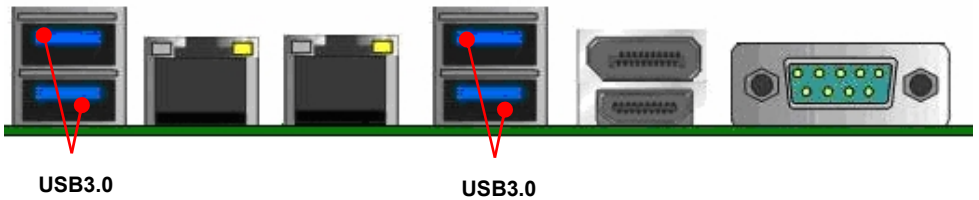
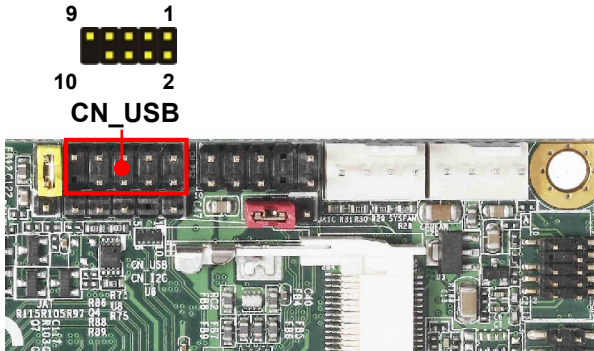

CN_USB: Front panel USB2.0 10-pin header (Pitch 2.54mm)

Pin	Signal	Pin	Signal
1	5VSB	2	5VSB
3	DATA0-	4	DATA1-
5	DATA0+	6	DATA1+
7	GND	8	GND
9	GND	10	Key

2.4.6 <Audio interface>

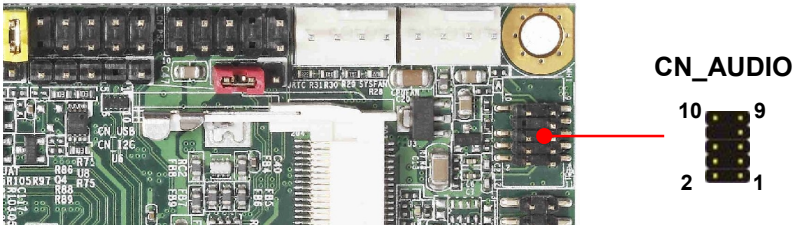

CN_AUDIO: Front panel audio 10-pin header (Pitch 1.27mm x 2.54mm)

Pin	Signal	Pin	Signal
1	MIC_L	2	GND
3	MIC_R	4	NC
5	FP_OUT_R	6	MIC_DETECT
7	SENSE	8	Key
9	FP_OUT_L	10	FP_OUT_DETECT

2.4.7 <Expansion slot>

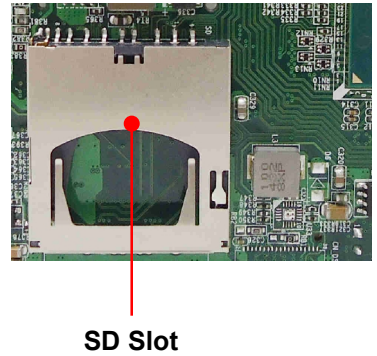
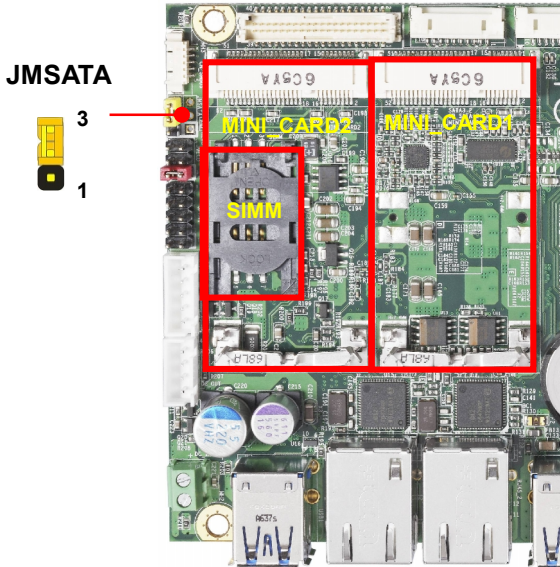

MINI_CARD1 support mSATA by JMSATA
 MINI_CARD2 connect SIM card with 3G module.

JMSATA: Setting MINI_CARD1 to support PCIe/mSATA

Jumper settings	Function
1-2	Support mSATA
2-3	Normal operation (Default)

(CN_SATA2 cannot use when Minicard1 change to mSATA)

SD Slot:

Pin	Signal	Pin	Signal
1	SD_D3	2	SD_CMD
3	3.3V	4	NC
5	SD_CLK	6	GND
7	SD_D0	8	SD_D1
9	SD_D2	10	SD_CD
11	GND	12	GND
13	SD_WP		

2.4.8 <Front panel switch and indicator>

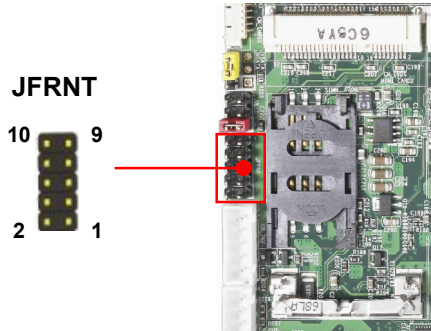

JFRNT: Front panel switch and indicator 14-pin header (Pitch 2.54mm)

Pin	Signal	Pin	Signal
1	Power_ON-	2	Power_ON+
3	Speaker-	4	Speaker+
5	HDD_LED-	6	HDD_LED+
7	Power_LED-	8	Power_LED+
9	Reset+	10	Reset-

2.4.9 <Other interface>

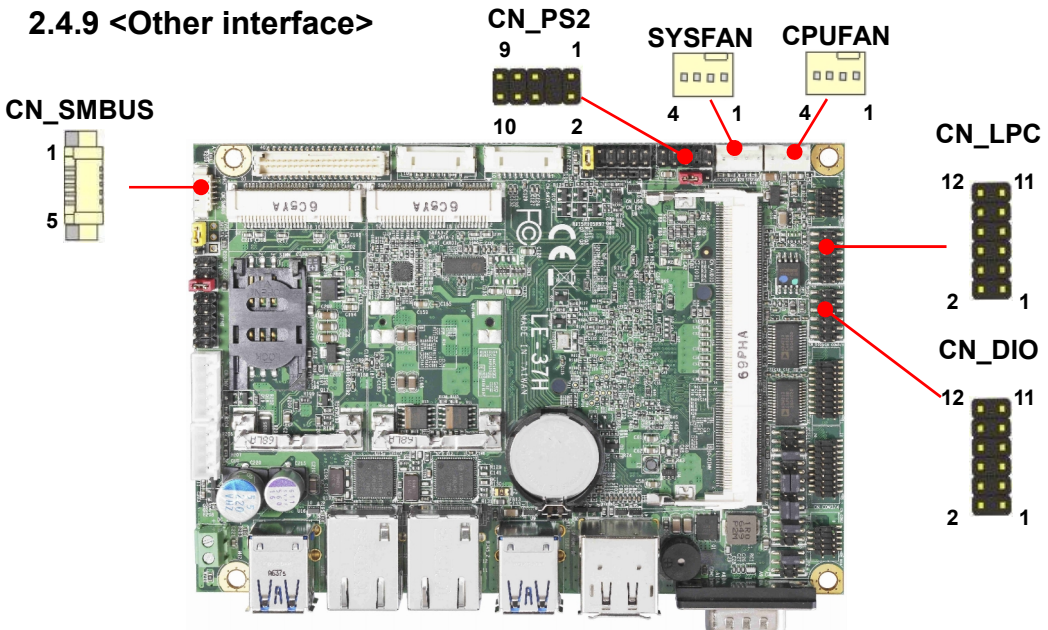

CN_LPC: LPC 12-pin header (Pitch 2.00mm)

Pin	Signal	Pin	Signal
1	CLK	2	RST
3	-LFRAME	4	LAD3
5	LAD2	6	LAD1
7	LAD0	8	3.3V
9	SERIRQ	10	GND
11	3.3VSB	12	NC

CN_DIO: GPIO 12-pin header (Pitch 2.00mm)

Pin	Signal	Pin	Signal
1	GND	2	GND
3	GPIO0	4	GPIO4
5	GPIO1	6	GPIO5
7	GPIO2	8	GPIO6
9	GPIO3	10	GPIO7
11	5V	12	12V

CN_SMBUS: SMBus 5-pin connector

Pin	Signal
1	5V
2	NC
3	SMBDAT
4	SMBCLK
5	GND

CN_PS/2: PS/2 10-pin header (Pitch 2.54mm)

Pin	Signal	Pin	Signal
1	KB_DATA	2	M_DATA
3	NC	4	NC
5	GND	6	GND
7	VCC	8	VCC
9	KB_CLK	10	M_CLK

CPUFAN: CPU cooler fan 4-pin connector

Pin	1	2	3	4
Signal	GND	12V	Sensor	Control

SYSFAN: System cooler fan 4-pin connector

Pin	1	2	3	4
Signal	GND	12V	Sensor	Control

2.5 <Power supply>

2.5.1 <Power input>

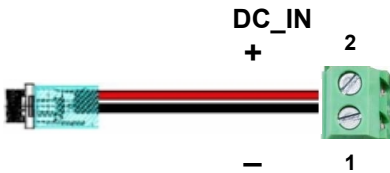

DC_IN: Terminal Block 2-pin power connector

Pin	Signal	Pin	Signal
1	GND	2	Power in

The power support 9~24V wide voltage input.

2.5.2 <Power output>

DC_OUT: SATA power 4-pin connector

Pin	Signal
1	12V
2	GND
3	GND
4	5V

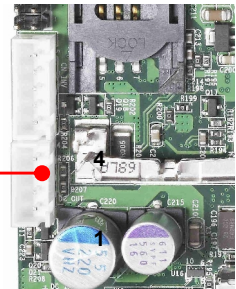
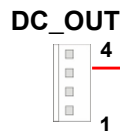

Appendix A <Flash BIOS>

A.1 BIOS Auto Flash Tool

The board is based on Insyde BIOS and can be updated easily by the BIOS auto flash tool. You can download the tool online at the address below:

[LE-37H DOS reflash tool](#)

A.2 Flash Method

1. Please make a bootable UFD which can boot into DOS environment.
2. Unzip the flash tool and copy it into bootable UFD.
3. Add a bin file to the same folder..
4. Power on the system and flash the BIOS under the DOS environment.
(Command: H2OFFT xxx.bin -all)
5. Power off the system and then power on

Appendix B <Setup ADP-3355,ADP-3460>

LE-37HT Series have a CRT or 2nd LVDS, it's no need install extra driver. For further information, please refer to the manual.

ADP-3355 manual [Link](#)

ADP-3460 manual [Link](#)

Appendix C <LCD Panel Type select>

According to your panel, it needs to select the correct resolution in the BIOS.
 If there is no fit for your panel type, please provide feedback for us to make an OEM model.

Find the setting from

Front page-----> Setup Utility

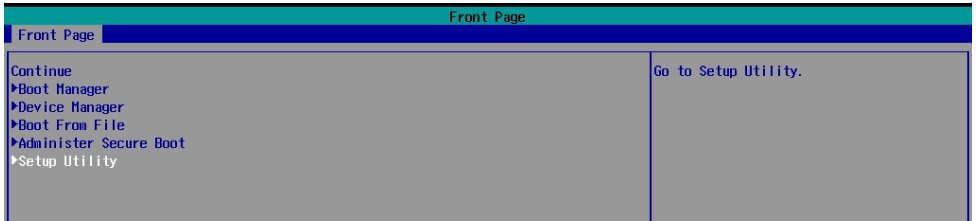

Advanced-----> Uncore Configuration----->VBT Hook Configuration

You can change 18bit /24bit, Single /Dual channel in PTN3460 configuration

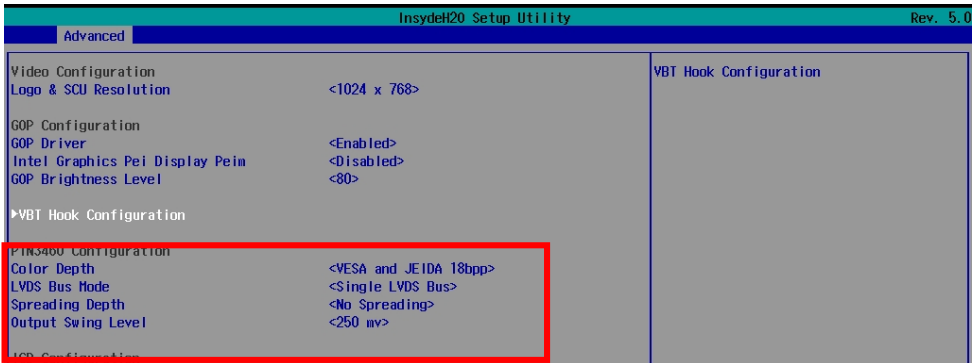

There are 16 resolutions in Panel Number.

InsydeH20 Setup Utility Rev. 5.0

Advanced

VBT Hook Configuration

LFP 1 Configuration <eDP>
 Output Port <eDP Port A>
 Aux Channel <DP Port A>
 Panel Number <640 x 480>
 EDID Support <Disabled>
 HPD Inversion <Enabled>
 DDI Lane Reversal <Disabled>

EFP 1 Configuration <HDMI/DVI>
 Output Port <HDMI Port B>
 DDC Bus Pin <HDMI Port B>
 Aux Channel <DP Port B>
 HDMI Level Shifter <400 mV 0.0dB>
 Onboard LSPCON for HDMI 2.0 <Disabled>
 HPD Inversion <Enabled>
 DDI Lane Reversal <Disabled>
 USB TypeC Dongle <Disabled>
 Dockable Port <Disabled>

EFP 2 Configuration <DisplayPort>
 Output Port <DP Port C>
 DDC Bus Pin <HDMI Port C>
 Aux Channel <DP Port C>
 HDMI Level Shifter <800 mV 3.5dB>
 Onboard LSPCON for HDMI 2.0 <Disabled>
 HPD Inversion <Enabled>
 DDI Lane Reversal <Disabled>
 USB TypeC Dongle <Enabled>
 Dockable Port <Disabled>

EFP 3 Configuration <No Device>

Select LFP panel number (Panel Type define in VBT table)

Panel Number

VBT Default

640 x 480

800 x 600

1024 x 768

1280 x 1024

1400 x 1050

1400 x 1050

1600 x 1200

1366 x 768

1680 x 1050

1920 x 1200

1440 x 900

1600 x 900

1024 x 768

1280 x 800

1920 x 1080

OEM Keep

F1 Help ↑/↓ Select Item F5/F6 Change Values F9 Setup Defaults
 Esc Exit ←/→ Select Item Enter Select ▸ SubMenu F10 Save and Exit

BIOS panel type selection form (BIOS Version:1.0)			
Single / Dual channel		Single / Dual channel	
NO.	Type	NO.	Type
1	Auto	9	1366 x 768
2	640 x 480	10	1680 x 1050
3	800 x 600	11	1920 x 1200
4	1024 x 768	12	1400 x 900
5	1280 x 1024	13	1600 x 900
6	1400 x 1050 Reduced Blanking	14	1024 x 768
7	1400 x 1050 non-Reduced Blanking	15	1280 x 800
8	1600 x 1200	16	1920 x 1080
		17	OEM keep

Appendix D <Programmable Watch Dog Timer>

Timeout value range

1 to 255 Minute and Second

Program sample

Watchdog timer setup as system reset with 5 second of timeout

```
-o 4E 87      ;enter configuration
-o 4E 87
-o 4E 07
-o 4F 08      ;select Logical Device
-o 4E 30
-o 4F 01      ; activate WDTO# function
-o 4E F5
-o 4F 00      ;set "00" is second mode, set "04" is minute mode
-o 4E F6
-o 4F 05      ;00h: Timeout Disable
                ;01h: Timeout occurs after 1 minute only
                ;02h: Timeout occurs after 2 second/minute
                ;03h: Timeout occurs after 3 second/minute
                ;
                ;FFh: Timeout occurs after 255 second/minute
                (The deviation is approx 1 second.)
```

For further information, please refer to Nuvoton NCT6106D datasheet

Appendix E <Programmable GPIO >

The GPIO' can be programmed with the MS-DOS debug program using simple IN/OUT commands.

GPIO	0	1	2	3	4	5	6	7
bit	0	1	2	3	4	5	6	7

- o 4E 87 ;enter configuration
- o 4E 87
- o 4E 07
- o 4F 07 ;select Logical Device
- o 4E 30
- o 4F 10 ;activate GPIO function (The board use GPIO4)
- o 4E F0
- o 4F XX ;set "01" GPIO as input, set "00" GPIO as output
- o 4E F1
- o 4F XX ;if set GPIO as output, this register's value can be set "00~ FF"

Optional

- o 4E F2
- o 4F XX ;set "01", the respective bit are inverted (Both input and output)
;set "00", the respective bit are normal

For further information, please refer to Nuvoton NCT6106D datasheet

Appendix F <SuperIO Setting>

Press **Delete** to enter BIOS Setup menu

On **Front Page** screen, click **Setup Utility**

On **Advanced** screen, click **SIO NUVOTON6106D**

There are 5 functions in the page.

- 1.WDT(Watch Dog Timer)
- 2.Power Loss setting
- 3.Hardware monitor
- 4.Smart fan
- 5.OVT (Over temperature)

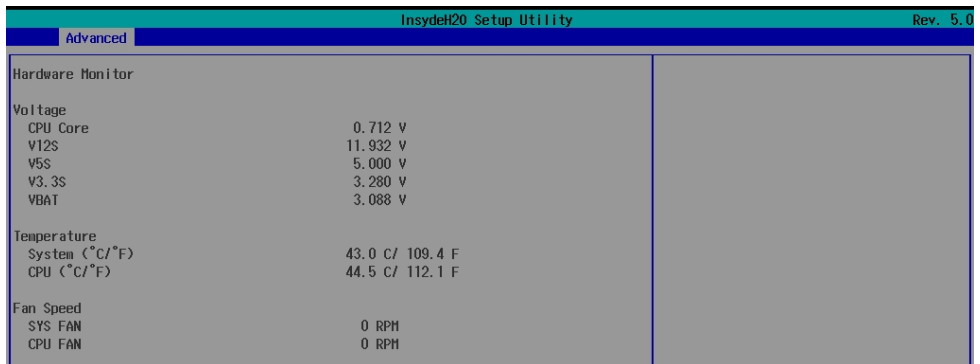

Contact information

Any advice or comment about our products and service, or anything we can help you please don't hesitate to contact with us. We will do our best to support you for your products, projects and business.

Taiwan Commate computer Inc.

Address	19F., NO.94, Sec. 1, Xintai 5 th Rd., Xizhi Dist., New Taipei City 22102, Taiwan.
TEL	+886-2-26963909
FAX	+886-2-26963911
Website	www.commell.com.tw
E-mail	info@commell.com.tw (General information) tech@commell.com.tw (Technical Support)

Commell is a brand name of Taiwan Commate computer Inc.