

# Spectra PowerBox 210-Series

USER MANUAL

Version 1.15 – February 2021



# Contents

## Preface

Revision.....	05
Copyright Notice.....	05
Acknowledgement.....	05
Disclaimer.....	05
Declaration of Conformity.....	05
Product Warranty Statement .....	06
Technical Support and Assistance.....	07
Conventions Used in this Manual .....	08
Safety Precaution .....	08
Package Contents .....	10
Ordering Information .....	10

## Chapter 1 Product Introductions

1.1 Overview .....	12
1.2 Highlights .....	12
1.3 Product Pictures.....	13
1.4 Key Features .....	13
1.5 Hardware Specification .....	14
1.6 System I/O .....	15
1.6.1 Front .....	15
1.6.2 Rear .....	16
1.7 Mechanical Dimension .....	17

## Chapter 2 Switches and Connectors

2.1 Location of Switches and Connectors .....	19
2.1.1 Top View .....	19
2.1.2 Bottom View .....	20
2.2 Switches and Connectors Definition.....	21
2.3 Definition of Switches.....	22
2.4 Definition of Connectors .....	24

## Chapter 3 System Setup

3.1 Removing the Top Cover .....	29
3.2 Installing SO-DIMM Memory.....	31
3.3 Installing Mini-PCIe Cards on Bottom Side.....	32
3.4 Installing a SATA Hard Drive.....	34
3.5 Installing a Half-Slim SSD.....	35

3.6 Installing Antennas.....	36
3.7 Installing CPU Heatsink Thermal Pad.....	38
3.8 Assembling the System.....	38
3.9 Installing a SIM Card.....	40
3.10 Wall Mount Brackets.....	41
3.11 DIN-Rail Mount.....	42

## Chapter 4 BIOS Setup

4.1 BIOS Introduction .....	44
4.2 Main Setup .....	45
4.2.1 System Date .....	45
4.2.2 System Time .....	45
4.3 Advanced Setup .....	46
4.3.1 ACPI Settings .....	46
4.3.2 F81866 Super IO Configuration.....	47
4.3.3 Hardware Monitor.....	48
4.3.4 S5 RTC Wake Settings.....	49
4.3.5 Serial Port Console Redirection.....	49
4.3.6 CPU Configuration.....	50
4.3.7 Network Stack Configuration.....	50
4.3.8 CSM Configuration.....	51
4.3.9 USB Configuration.....	52
4.4 Chipset Setup .....	53
4.4.1 North Bridge .....	53
4.4.2 South Bridge.....	54
4.4.3 South Cluster Configuration.....	55
4.5 Security Setup .....	58
4.5.1 Administrator Password .....	58
4.5.2 User Password .....	58
4.6 Boot Setup .....	59
4.7 Save & Exit .....	60

## Chapter 5 Product Application (For DIO Only)

5.1 Digital I/O (DIO) application .....	62
5.1.1 Digital I/O Programming Guide .....	62
5.2 Digital I/O (DIO) Hardware Specification .....	73
5.2.1 DIO Connector Definition .....	74

## Chapter 6 Optional Modules and Accessories

6.1 Location of the Connectors for CMI Modules.....	78
6.2 Location of the Connector for PB-210-IGN Module.....	80
6.3 Location of the Connector for PB-210-PoE Module.....	81
6.4 PB-210-COM Connector Definition and Settings.....	82
6.5 PB-210-IGN Switches Definition and Settings.....	84
6.6 Installing a PB-210-DVI Module.....	85
6.7 Installing a PB-210-VGA Module.....	87
6.8 Installing a PB-210-HD Module.....	89
6.9 Installing a PB-210-COM Module.....	91
6.10 Installing a PB-210-DIO Module.....	93
6.11 Installing a PB-210-IGN Module.....	95
6.12 Installing a PB-210-PoE Module.....	96
6.13 Installing a PB-210-MEC-LAN Module.....	98
6.14 Installing a PB-210-MEC-COM Module.....	103
6.15 Installing a Side Mount Bracket.....	107
6.16 Installing a VESA Mount Bracket .....	109

# Preface

## Revision

Revision	Description	Date
1.00	First Release	2019/02/01
1.10	Add E-mark Certified/ Correction Made	2019/05/03
1.11	CMI Module Name Updated	2019/08/08
1.12	Correction Made	2020/04/09
1.13	New Format Updated	2020/10/22
1.14	Correction Made	2020/11/13
1.15	Add Half Slim SSD/ MEC-LAN/ MEC-COM Installation	2021/01/25

## Copyright Notice

© 2021 by Spectra GmbH & Co. KG. All rights are reserved. No parts of this manual may be copied, modified, or reproduced in any form or by any means for commercial use without the prior written permission of Spectra GmbH & Co. KG. All information and specification provided in this manual are for reference only and remain subject to change without prior notice.

## Acknowledgement

All registered trademarks and product names mentioned herein are used for identification purposes only and may be trademarks and/or registered trademarks of their respective owners.

## Disclaimer

This manual is intended to be used as a practical and informative guide only and is subject to change without notice. It does not represent a commitment on the part of Spectra. This product might include unintentional technical or typographical errors. Changes are periodically made to the information herein to correct such errors, and these changes are incorporated into new editions of the publication.

## Declaration of Conformity



### FCC

This equipment has been tested and found to comply with the limits for a Class A digital device, pursuant to Part 15 of the FCC Rules. These limits are designed to provide reasonable protection against harmful interference when the equipment is operated in a commercial environment. This equipment generates, uses, and can radiate radio frequency energy and, if not installed and used in accordance with the instruction manual, may cause harmful interference to radio communications. Operation of this equipment in a

residential area is likely to cause harmful interference in which case the user will be required to correct the interference at his own expense.



## CE

The product(s) described in this manual complies with all application European Union (CE) directives if it has a CE marking. For computer systems to remain CE compliant, only CE-compliant parts may be used. Maintaining CE compliance also requires proper cable and cabling techniques.

## Product Warranty Statement

### Warranty

Spectra products are warranted by Spectra GmbH & Co. KG to be free from defect in materials and workmanship starting from the date of purchase by the original purchaser. The actual warranty period of Spectra products vary with product categories. During the warranty period, we shall, at our option, either repair or replace any product that proves to be defective under normal operation.

Defects, malfunctions, or failures of the warranted product caused by damage resulting from natural disasters (such as by lightning, flood, earthquake, etc.), environmental and atmospheric disturbances, other external forces such as power line disturbances, plugging the board in under power, or incorrect cabling, and damage caused by misuse, abuse, and unauthorized alteration or repair, and the product in question is either software, or an expendable item (such as a fuse, battery, etc.), are not warranted.

### RMA

- Before sending your product in, you will need to fill in a Spectra RMA Request Form and obtain a RMA number from us. Please go to [www.spectra.de/RMA](http://www.spectra.de/RMA) to fill in this form. Our staff is available at any time to provide you with the most friendly and immediate service.
- **RMA Instruction**
  - Customers must fill in Spectra Return Merchandise Authorization (RMA) Request Form and obtain a RMA number prior to returning a defective product to Spectra for service.
  - Customers must collect all the information about the problems encountered and note anything abnormal and describe the problems on the “Spectra Service Form” for the RMA number apply process.
  - Charges may be incurred for certain repairs. Spectra will charge for repairs to products whose warranty period has expired. Spectra will also charge for repairs to products if the damage resulted from acts of God, environmental or atmospheric disturbances, or other external forces through misuse, abuse, or unauthorized alteration or repair. If charges will be incurred for a repair, Spectra lists all charges, and will wait for customer’s approval before performing the repair.

- Customers agree to insure the product or assume the risk of loss or damage during transit, to prepay shipping charges, and to use the original shipping container or equivalent.
- Customers can be send back the faulty products with or without accessories (manuals, cable, etc.) and any components from the system. If the components were suspected as part of the problems, please note clearly which components are included. Otherwise, Spectra is not responsible for the devices/parts.
- Repaired items will be shipped along with a "Repair Report" detailing the findings and actions taken.

## Technical Support and Assistance

1. Visit the Spectra website at [www.spectra.de](http://www.spectra.de) where you can find the latest information about the product.
2. Contact our technical support team or sales representative for technical support if you need additional assistance. Please have following information ready before you call:
  - Product name and serial number
  - Description of your peripheral attachments
  - Description of your software (operating system, version, application software, etc.)
  - A complete description of the problem
  - The exact wording of any error messages

## Conventions Used in this Manual



### WARNING

This indication alerts operators to an operation that, if not strictly observed, may result in severe injury.



### CAUTION

This indication alerts operators to an operation that, if not strictly observed, may result in safety hazards to personnel or damage to equipment.



### NOTE

This indication provides additional information to complete a task easily.

## Safety Precautions

Before installing and using this device, please note the following precautions.

1. Read these safety instructions carefully.
2. Keep this User's Manual for future reference.
3. Disconnect this equipment from any AC outlet before cleaning.
4. For plug-in equipment, the power outlet socket must be located near the equipment and must be easily accessible.
5. Keep this equipment away from humidity.
6. Put this equipment on a reliable surface during installation. Dropping it or letting it fall may cause damage.
7. Make sure the voltage of the power source is correct before connecting the equipment to the power outlet.
8. Use a power cord that has been approved for using with the product and that it matches the voltage and current marked on the product's electrical range label. The voltage and current rating of the cord must be greater than the voltage and current rating marked on the product.
9. Position the power cord so that people cannot step on it. Do not place anything over the power cord.
10. All cautions and warnings on the equipment should be noted.
11. If the equipment is not used for a long time, disconnect it from the power source to avoid damage by transient overvoltage.
12. Never pour any liquid into an opening. This may cause fire or electrical shock.



13. Never open the equipment. For safety reasons, the equipment should be opened only by qualified service personnel.

If one of the following situations arises, get the equipment checked by service personnel:

- The power cord or plug is damaged.
- Liquid has penetrated into the equipment.
- The equipment has been exposed to moisture.
- The equipment does not work well, or you cannot get it work according to the user's manual.
- The equipment has been dropped and damaged.
- The equipment has obvious signs of breakage.

14. CAUTION: Danger of explosion if battery is incorrectly replaced. Replace only with the same or equivalent type recommended by the manufacturer.

15. Equipment intended only for use in a RESTRICTED ACCESS AREA.

## Package Contents

Before installation, please ensure all the items listed in the following table are included in the package.

Item	Description	Q'ty
1	PowerBox 210 Compact Size Fanless Embedded Computer	1
2	Utility DVD Driver	1
3	Thermal Pad (for CPU Thermal Block)	1
4	Power Terminal Block Connector	1
5	Screw Pack	1
6	Remote Power On/Off Terminal Block Connector	1
7	Wall Mounting Kit	1
8	DIN Rail Mounting Kit	1

Note: Notify your sales representative if any of the above items are missing or damaged.

## Ordering Information

Model No.	Product Description
<b>Spectra PowerBox 210-N42</b>	Intel® Pentium® Processor N4200 Compact Size Fanless Computer

# Chapter 1

## **Product Introductions**

## 1.1 Overview

Based on Intel® Pentium® N4200 quad-core processor, the Spectra PowerBox 210 is a fanless embedded computer offering an incredible size-performance ratio for the most challenging environments. Despite its compact size, the Spectra PowerBox 210 incorporates extensive connectivities including serial ports, USB 3.0, GbE LAN, full-size Mini-PCIe slot, dual SIM sockets, DVI-D, and DisplayPort. The system also provides 2.5" SATA drive bay and mSATA socket for extensive storage requirements.

Furthermore, it is much easier to utilize CMI& CFM modules for extension of digital I/O, serial ports, power ignition sensing, Power over Ethernet (PoE) even the third output of video for a variety of applications.

Featuring with rigorous industrial protections, wide temperature range, and wide range DC power input, the Spectra PowerBox 210 offers a powerful, expandable computing platform to ensure long-lasting performance and reduce maintenance costs.

## 1.2 Highlights



### Highly Efficient & Compact

The Spectra PowerBox 210 is powered by Intel® Pentium® N4200 (4 cores, 2.5 GHz) and constructed with a compact size aluminum housing. It can be easily installed into a control cabinet or any other space-limited environments.



### In-Vehicle Computer

Capable of 12V/24V DC power input, wide operating temperature, shock/vibration resistant, power ignition sensing, and E-mark certified, this robust fanless computer is specifically designed for demanding in-vehicle applications.



### Flexible & Modular Design

Based on CMI (Combined Multiple I/O) and CFM (Control Function Module) technologies, the Spectra PowerBox 210 can be easily configured to increase specified functions and a variety of I/O modules.

## 1.3 Product pictures



**Front**



**Rear**

## 1.4 Key Features

- Onboard Intel® Pentium® N4200 Processor
- Supports Triple Independent Display
- Supports CMI Interface for I/O Expandability
- Supports PoE+ and Power Ignition Function (with optional CFM modules)
- 1 x 2.5" SATA Drive Bay, 1x mSATA Socket
- 2 x Full Size Mini-PCIe Socket, 2 x SIM Card Socket
- Compact Size (185 x 131 x 56.5 mm)
- Wide Operating Temperature -40°C to 70°C
- E-mark (E13, No. 10R-0515075), LVD EN60950-1

# 1.5 Hardware Specification

## Processor

- Onboard Intel® Pentium® N4200 Quad Core Processor, up to 2.50 GHz

## BIOS

- AMI BIOS, 8MB SPI Flash ROM built on board

## Memory

- 1x DDR3L 1333/1600/1866 MHz 204-Pin SO-DIMM Socket
- Support up to 8GB (un-buffered and non-ECC)

## Graphics

- Integrated Intel® HD Graphics 505
- Supports Triple Independent Display (DVI-D, DisplayPort and one output from optional CMI module)

## Audio

- Realtek ALC888-GR

## External I/O Interface

- 1x DVI-D (1920 x 1080 @ 60 Hz)
- 1x DisplayPort (4K x 2K @60Hz)
- 2x GbE LAN (Support WoL, Teaming, Jumbo Frame & PXE), RJ45
  - GbE1: Intel® I210-IT
  - GbE2: Intel® I210-IT
- 4x USB 3.0 (Type A)
- 2x RS232/422/485 with Auto Flow Control (Supports 5V/12V), DB9
- 1x Line-out and 1x Mic-in, Phone Jack 3.5mm
- 1x ATX Power On/Off Button
- 1x Reset Button
- 1x AT/ATX Mode Switch
- 1x Clear CMOS Switch
- 1x Remote Power On/Off Connector, 2-pin Terminal Block
- 1x Ignition DIP Switch (12V/24V, need to work with CFM module)

## Storage

- 1x mSATA Socket (SATA 3.0, Shared by Mini-PCIe Socket)
- 1x 2.5" HDD/SSD Drive Bay (SATA 3.0)

## Expansion

- 2x Full-size Mini-PCIe Socket
- 2x Control Function Module (CFM) Interface
- 2x Combined Multiple I/O (CMI) Interface
- 2x SIM Card Socket
- 2x Antenna Hole

## Other Function

- Watchdog Timer: Software Programmable Supports 256 Levels System Reset
- SuperCap Integrated for CMOS Battery Maintenance-free Operation
- Supports Instant Reboot Technology (0.2 sec)

## Power Requirement

- Supports AT/ATX Power Type
- Power Input Voltage 9~48VDC
- 1x 3-pin Terminal Block
- Power Adapter AC/DC 12V/5A 60W or 24V/5A 120W (Optional)

## Physical

- Dimensions (WxDxH, mm): 185 x 131 x 56.5 mm
- Weight: 1.42 kg
- Construction: Extruded Aluminum with Heavy Duty Metal
- Mounting: Wall / VESA (Optional Side + DIN-Rail Mounting)
- Unibody Chassis
- Fanless Design
- Jumper-less Design
- Cable-less Design

## Protection

- Reverse Power Input Protection
- Over Voltage Protection
  - Protection Range: 51~58V
  - Protection Type: shut down operating voltage, re-power on at the present level to recover
- Over Current Protection: 15A
- ESD Protection: +/- 8kV (air), +/- 4kV (contact)
- Surge Protection: 3.84kV (impedance 12 ohm 1.2/50us waveform)

## Operating System

- Windows® 10
- Linux: Supports by project

## Environment

- Operating Temperature: -40°C to 70°C
  - \* With extended temperature peripherals; Ambient with air flow
  - \* According to IEC60068-2-1, IEC60068-2-2, IEC60068-2-14
- Storage Temperature: -40°C to 85°C
- Relative Humidity: 95% RH @ 70°C (non-Condensing)
- Shock: Operating, 50 Grms, Half-sine 11 ms Duration
  - \* w/ SSD, according to IEC 60068-2-27
- Vibration: Operating, 5 Grms, 5-500 Hz, 3 Axes
  - \* w/ SSD according to IEC 60068-2-64
- MTBF: 479,119 Hours

## Certification

- EMC: CE, FCC Class A
- Safety: LVD (EN60950-1)
- In-Vehicle: E-Mark (E13, No. 10R-0515075)

## 1.6 System I/O

### 1.6.1 Front

#### ATX Power On/Off Switch

Press to power-on or power-off the system

#### Power LED

Indicates the power status of the system

#### HDD LED

Indicates the status of the hard drive

#### Line-Out

Used to connect a speaker

#### Mic-In

Used to connect a microphone

#### USB 3.0 Port

Used to connect USB 3.0/2.0/1.1 device

#### LAN Port 1 & 2

Used to connect the system to a local area network

#### DisplayPort Port

Used to connect the system with DisplayPort monitor

#### Universal I/O Bracket

Used for customized I/O output with optional modules

#### Reset Button

Used to reset the system

#### AT/ATX Switch

Used to select AT or ATX power mode

#### SIM Card Slot

Used to insert a SIM Card

#### IGN Setting Switch

Used to set up IGN function

#### Clear CMOS

Used to clear CMOS to reset BIOS

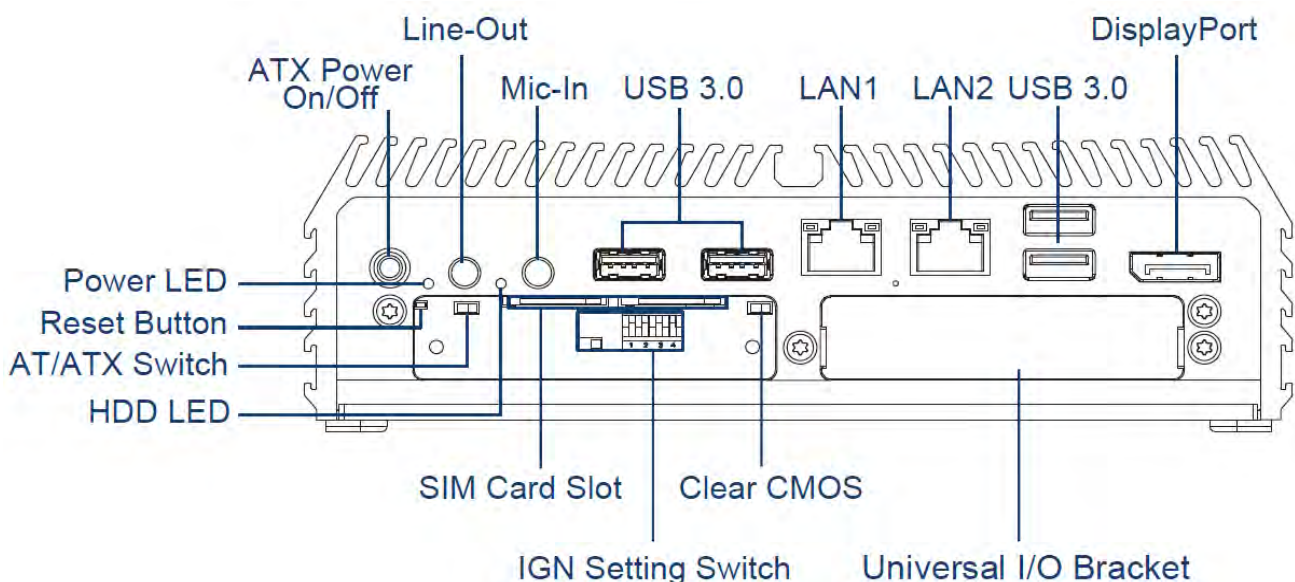

### 1.6.2 Rear

### Antenna Hole

Used to connect an antenna for optional Mini-PCIe WiFi module

### DC IN Terminal Block

Used to plug a DC power input with terminal block

### COM Port

COM 1 ~ COM 2 support RS232/422/485 serial device

### DVI-D Port

Used to connect a DVI monitor or connect optional split cable for dual display mode

### Remote Power On/Off Terminal Block

Used to plug a remote power on/off terminal block

### Universal I/O Bracket

Used for customized I/O output with optional modules

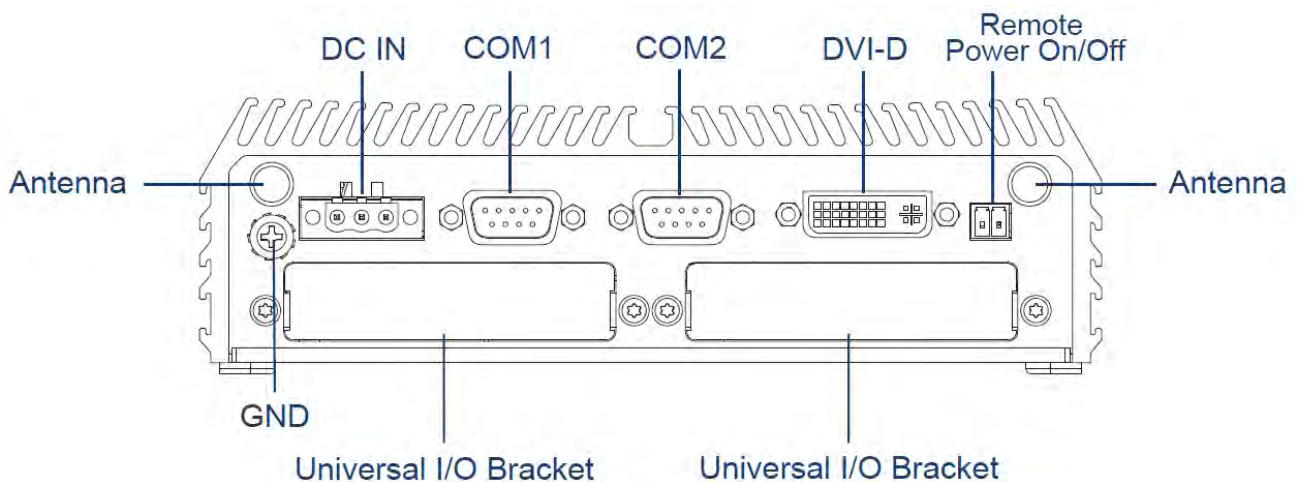



## 1.7 Mechanical Dimension

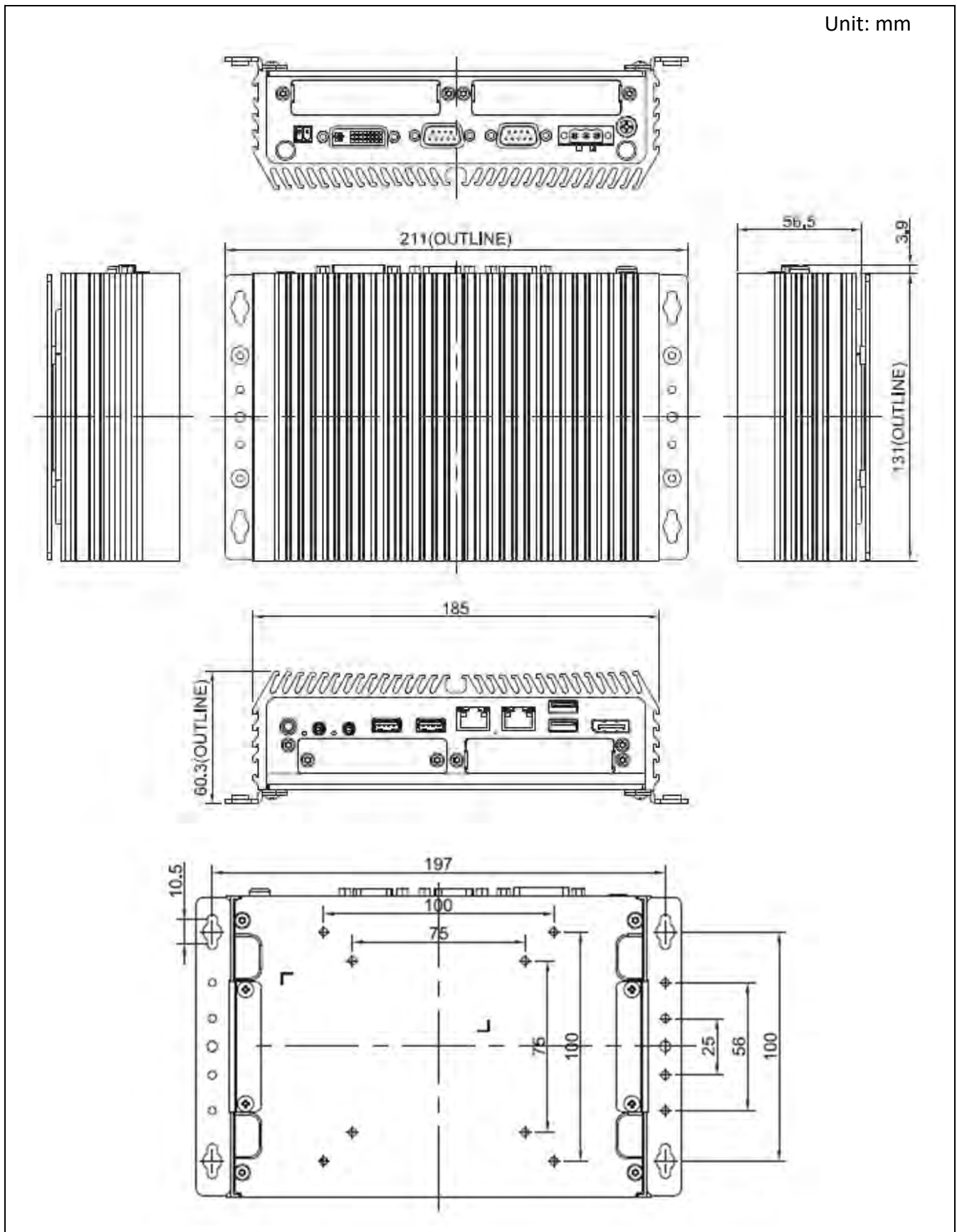

# Chapter 2

## **Switches & Connectors**

## 2.1 Location of Switches and Connectors

### 2.1.1 Top View

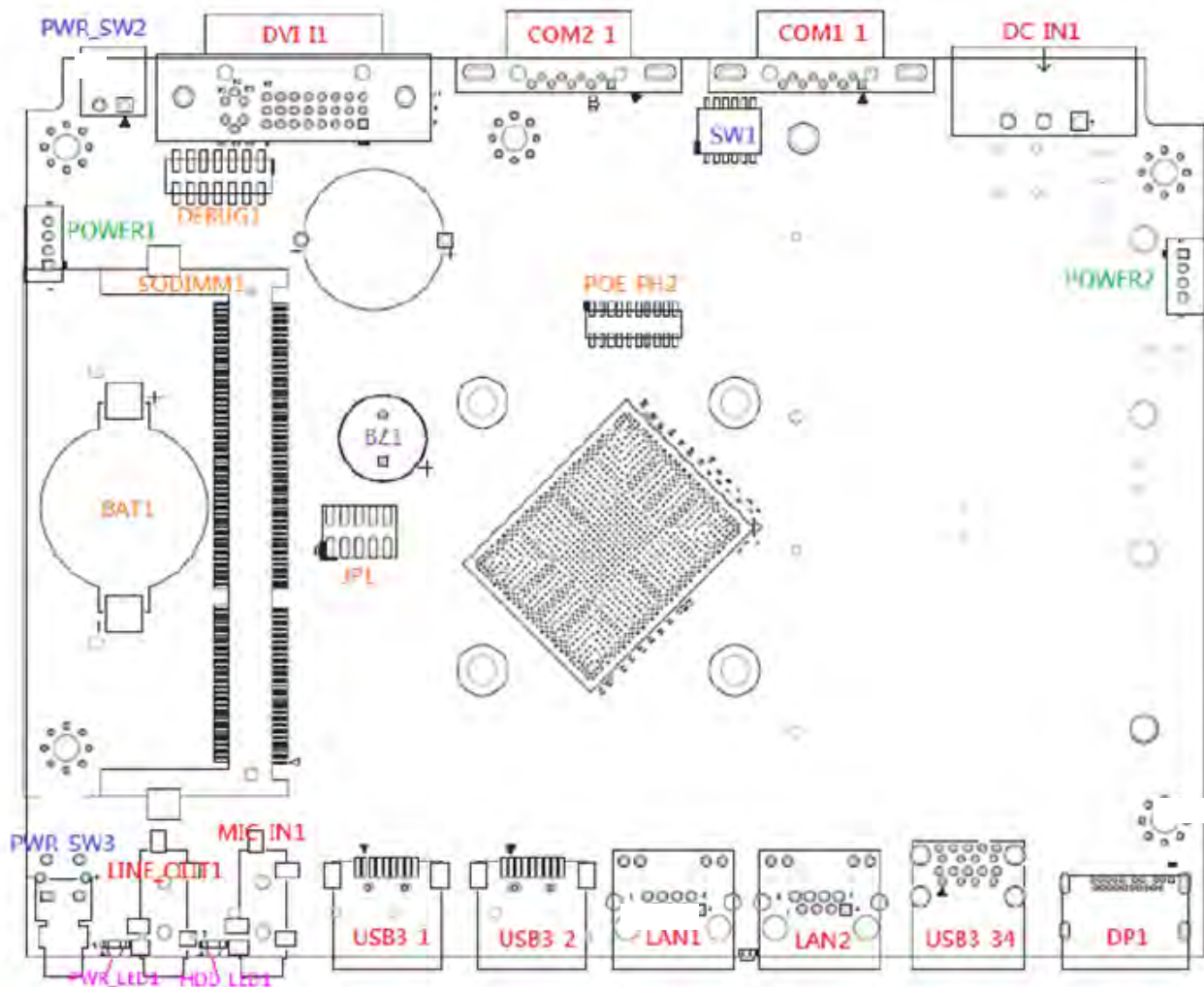

## 2.1.2 Bottom View

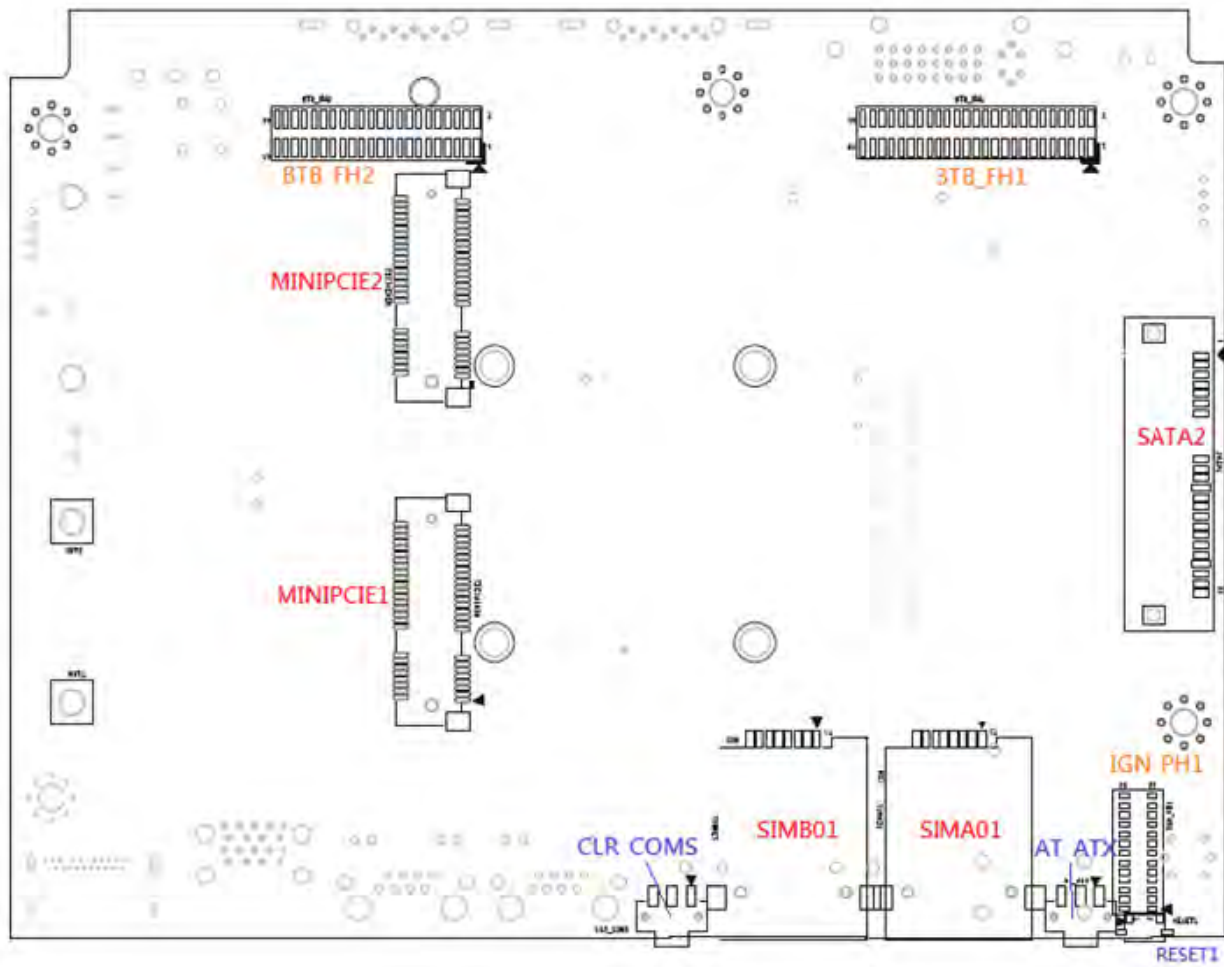

## 2.2 Switches and Connectors Definition

### List of Switches

Location	Definition
POWER_SW3	ATX Power on/off Button
SW1	Super CAP Switch and COM1~2 Power Select Switch
Reset1	Reset Button
AT_ATX	AT/ ATX Power Mode Switch
CLR_CMOS1	Clear BIOS Switch
SW2	IGN Module Timing Setting Switch
24V_12V_1	IGN Module Voltage Mode Setting Switch

### List of Connectors

Location	Definition
POWER_SW2	Remote Power On/Off Connector
DC_IN1	3-pin DC 9~48V Power Input with Power Ignition Connector
DVI_I1	DVI-D Connector
COM1_1, COM1_2	COM1~COM2 RS232 / RS422 / RS485 Connectors
DP1	DisplayPort Connector
USB3_1, USB3_2	USB 3.0 Ports
USB3_34	USB 3.0 Ports
LAN1, LAN2	RJ45 with LED Connector
MIC_IN1	Audio Jack MIC IN
LINE_OUT1	Audio Jack LINE OUT
SODIMM1	204-pin DDR3L SO-DIMM Sockets
Power1, Power2	+5V / +12V Power Output Connectors
SATA2	22-pin SATA Connector
MINIPCIE1	Mini PCIE+SIM/USB3 Socket
MINIPCIE2	Mini PCIE/mSATA Socket
SIMA01, SIMB01	SIM Card Sockets (apply with MINIPCIE1)
BTB_FH1	CMI BTB 50-pin header connector (Support DVI-D/VGA/HDMI/DIO/COM Ports)
BTB_FH2	CMI BTB 44-pin header connector (Support DIO/COM Ports)
IGN_PH1	IGN Board to Board Connector
POE_PH2	20-pin POE Board to Board Connector

## 2.3 Definition of Switches

### PWR\_SW3: System Power on/off Button

Switch	Definition
Push	Power on/off System



### RESET1: Reset Button

Switch	Definition
Push	Reset System



### AT\_ATX1: AT / ATX Power Mode Switch

Switch	Definition
1-2 (Left)	AT Power Mode
2-3 (Right)	ATX Power Mode (Default)



### CLR\_CMOS: Clear CMOS Switch

Switch	Definition
1-2 (Left)	Clear CMOS
2-3 (Right)	Normal Status (Default)

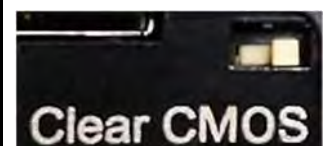

### POWER\_LED1: Power Status LED

Power Status	LED Color
POWER ON	Green



### HDD\_LED1: HDD Status LED

HDD Status	LED Color
HDD Read/Write	Yellow



### PWR\_SW\_LED: LED of Temperature Status

Temperature Status	LED Color
0°C ~ 60°C	Colorless
60°C ~ 87°C	Blue
Over 87°C	Red



### SW1: Super CAP Switch and COM1~2 with Power Select Switch

Function Setting via DIP Switch

Location	Function		DIP1	DIP2
SW1	SUPER CAP	Enabled	ON (Default)	N/A
		Disabled	OFF	N/A

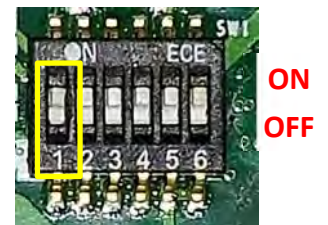

Location	Function		DIP3	DIP4
SW1	COM1	0V(RI)	ON (Default)	ON (Default)
		5V	ON	OFF
		12V	OFF	OFF

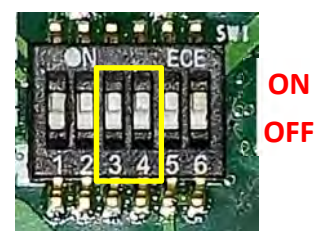

Location	Function		DIP5	DIP6
SW1	COM2	0V(RI)	ON (Default)	ON (Default)
		5V	ON	OFF
		12V	OFF	OFF

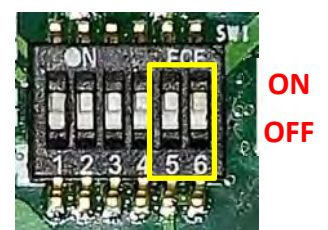

## 2.4 Definition of Connectors

### MINIPCIE1 : Mini PCI-Express Socket (Support mPCIE & SIM Module)

Pin	Definition	Pin	Definition	Pin	Definition
1	WAKE#	19	UIM_IC_DP / (UIM_DATA_B)	37	GND
2	3.3Vaux	20	W_DISABLE1#	38	USB_D+
3	NA	21	GND	39	+3.3Vaux
4	GND	22	PERST#	40	GND
5	NA	23	PERn0	41	+3.3Vaux
6	1.5V	24	+3.3Vaux	42	NA
7	UIM_RESET_B	25	PERp0	43	GND
8	UIM_PWR_A	26	GND	44	NA
9	GND	27	GND	45	NA
10	UIM_DATA_A	28	+1.5V	46	NA
11	REFCLK-	29	GND	47	NA
12	UIM_CLK_A	30	SMB_CLK	48	+1.5V
13	REFCLK+ / UIM_PWR_B	31	PETn0	49	NA
14	UIM_RESET_A	32	SMB_DATA	50	GND
15	GND	33	PETp0	51	NA
16	UIM_VPP_A	34	GND	52	+3.3Vaux
17	UIM_IC_DM / (UIM_CLK_B)	35	GND		
18	GND	36	USB_D-		

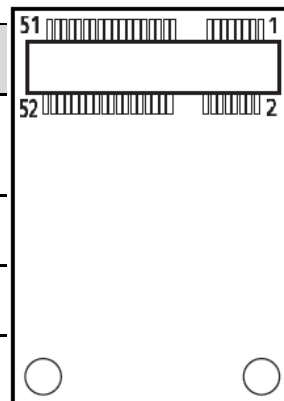



## MINIPCIE2 : Mini PCI-Express Socket (Support mPCIE & mSATA)

Pin	Definition	Pin	Definition	Pin	Definition
1	WAKE#	19	NA	37	GND
2	3.3V	20	W_DISABLE1#	38	USB_D+
3	NA	21	GND	39	+3.3Vaux
4	GND	22	PERST#	40	GND
5	NA	23	PERn0 / SATA_RXP	41	+3.3Vaux
6	1.5V	24	+3.3Vaux	42	NA
7	NA	25	PERp0 / SATA_RXN	43	GND
8	NA	26	GND	44	NA
9	GND	27	GND	45	NA
10	NA	28	+1.5V	46	NA
11	REFCLK-	29	GND	47	NA
12	NA	30	SMB_CLK	48	+1.5V
13	REFCLK+	31	PETn0 / SATA_TXN	49	NA
14	NA	32	SMB_DATA	50	GND
15	GND	33	PETp0 / SATA_TXP	51	NA
16	NA	34	GND	52	+3.3Vaux
17	NA	35	GND		
18	GND	36	USB_D-		

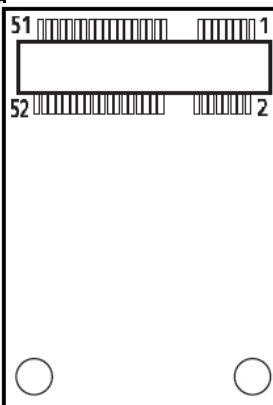

### PWR\_SW2: Remote Power On/Off Connector

Pin	Definition
1	PWR_SW
2	GND

**Note: DO NOT apply power to this CONNECTOR!!!**

**This port is used to connect a SWITCH!!!**



1 2

### DC\_IN1: DC Power Input Connector (+9~48V)

Connector Type: Terminal Block 1x3 3-pin, 5.0mm pitch

Pin	Definition
1	+9~48V IN
2	Ignition (IGN)
3	GND



1 2 3

### LAN1 / LAN2: LAN LED Status Definition

Act LED Status	Definition
Blinking Yellow	Data Activity
Off	No Activity

Link LED Status	Definition
Steady Green	1Gbps Network Link
Steady Orange	100Mbps Network Link
Off	10Mbps Network Link

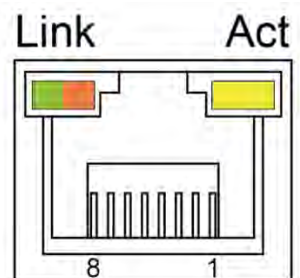

### COM1\_1 / COM2\_1: RS232 / RS422 / RS485 Connector

Connector Type: 9-pin D-Sub

Pin	RS232 Definition	RS422 / 485 Full Duplex Definition	RS485 Half Duplex Definition
1	DCD	TX-	DATA -
2	RXD	TX+	DATA +
3	TXD	RX+	
4	DTR	RX-	
5	GND		
6	DSR		
7	RTS		
8	CTS		
9	RI		



### POWER1, POWER2: Power Connector

Connector Type: 1x4 4-pin Wafer, 2.0mm pitch

Pin	Definition
1	+5V
2	GND
3	GND
4	+12V

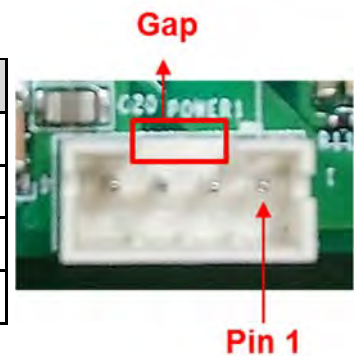

# Chapter 3

## **System Setup**

## 3.1 Removing the Top Cover



### WARNING

In order to prevent electric shock or system damage, before removing the chassis cover, must turn off power and disconnect the unit from power source.

1. Turn over the unit to have the bottom side face up, loosen the 4 screws of bottom cover and place them aside.



2. Remove the bottom cover from the chassis.



3. Hold front and rear panel and lift up the body of unit vertically.



4. Turn over the body of the unit and place it gently.



## 3.2 Installing SO-DIMM Memory

1. Locate the SO-DIMM sockets.

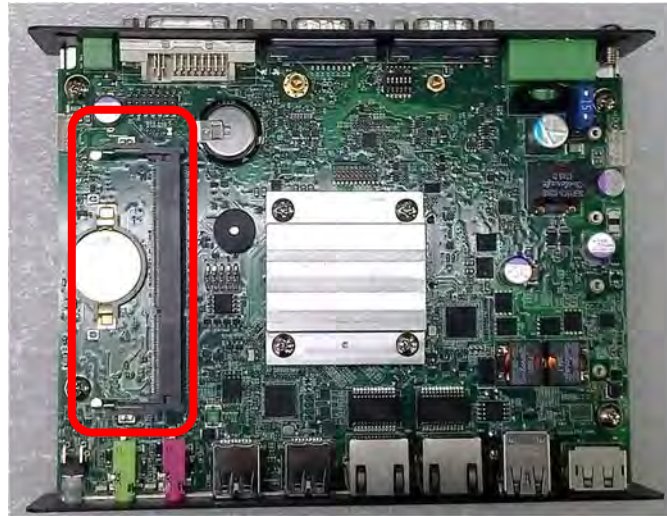

2. Tilt the SO-DIMM module at a 45-degree angle and insert it to SO-DIMM socket until the gold-pated connector of module contacted firmly with the socket.



3. Press the modules down until it's fixed firmly by the two locking latches on the sides.

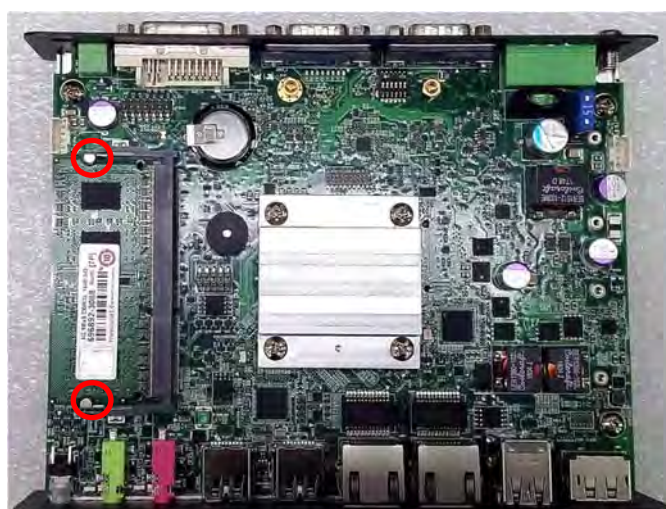

## 3.3 Installing Mini-PCIe Cards on Bottom Side

(Applicable for full or half size card)

1. Turn over the body of unit. Unscrew the 3 screws on HDD bracket and remove the bracket.

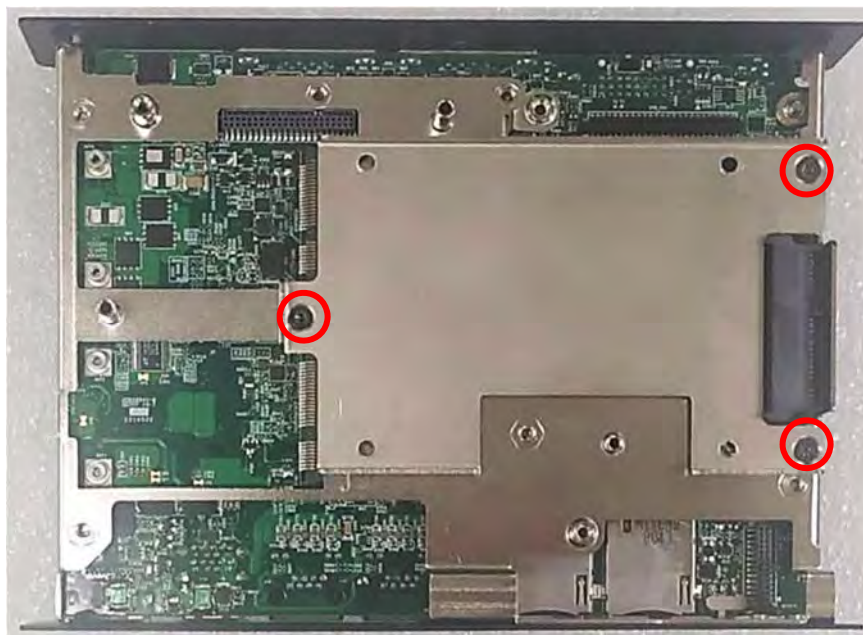

2. Locate the Mini PCIe slots.

Please note that the upside connector (MINIPCIIE2) is shared mSATA/Mini-PCIe interface, and downside connector (MINIPCIIE1) is Mini-PCIe interface which supports SIM Card to Link feature.

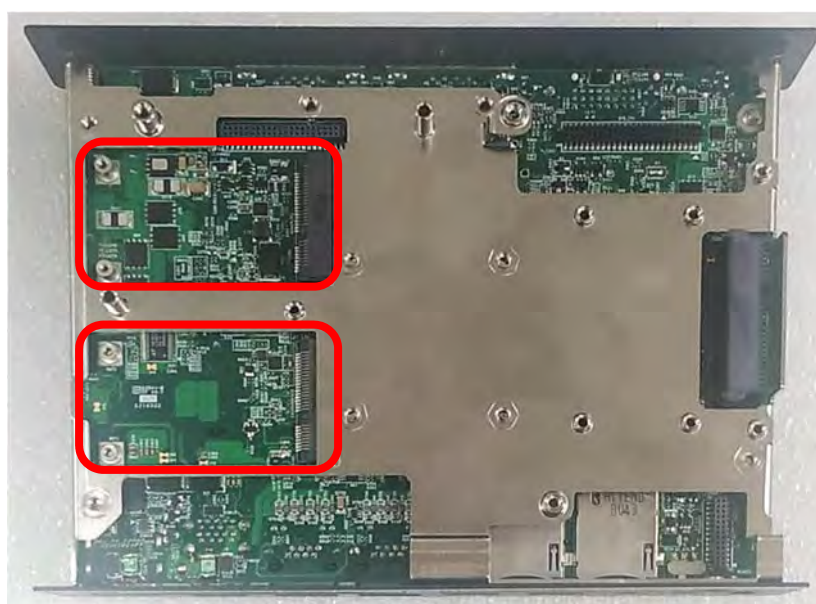



Insert the Mini-PCle card at a 45-degree angle and insert it to the slot until the gold-pated connector of module contacted firmly with the slot.

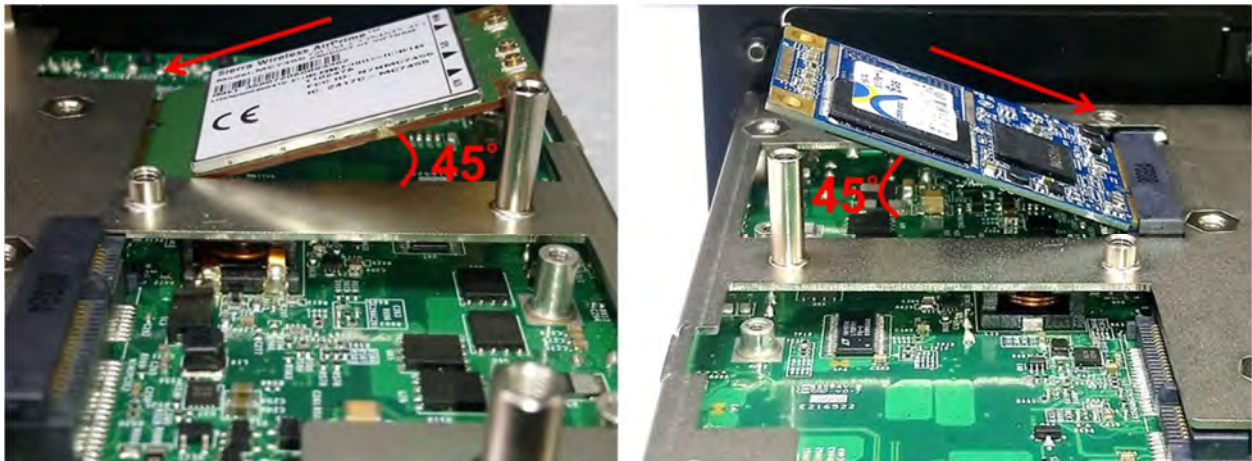

3. Press down the module and fasten two screws to secure the module.

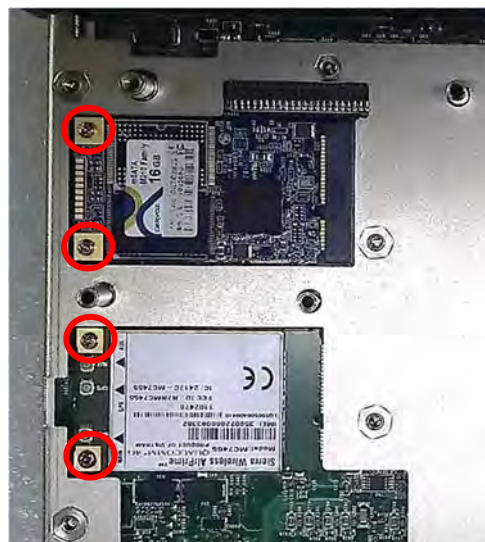

4. If you have a Half-size Mini-PCle card, make sure use extender to make it Full-size as shown below.



## 3.4 Installing a SATA Hard Drive

1. Lift up the empty HDD bracket by unscrewing the 3 screws.

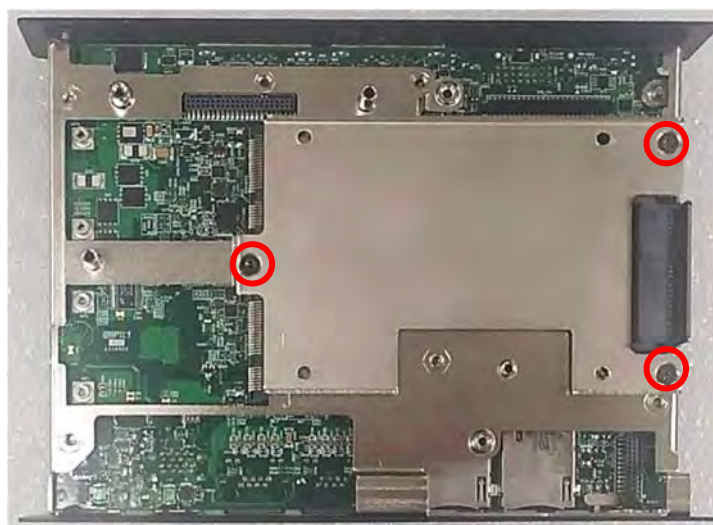

2. Make the PCB side of the HDD face up, place the HDD bracket on it. Ensure the direction of bracket is correct and use 4 provided screws to assemble HDD and HDD bracket together.

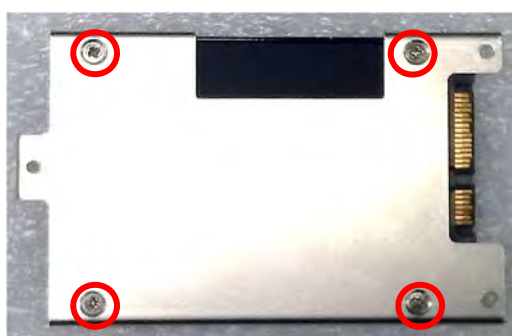

3. Turn over the HDD bracket. Connect the HDD bracket to the SATA connector of the unit and fasten the 3 screws.



## 3.5 Installing a Half-Slim SSD

1. Lift up the empty HDD bracket by unscrewing the 3 screws.

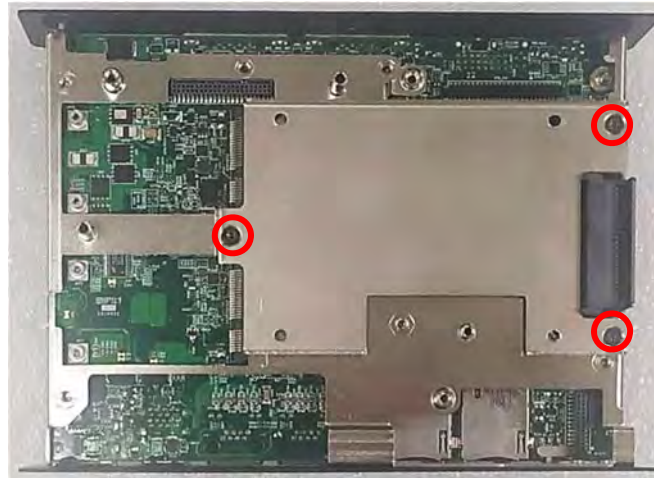

2. Fasten the 4 copper pillars.

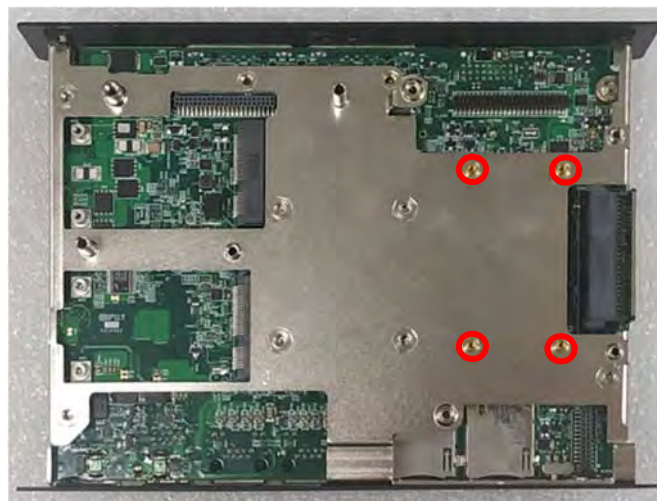

3. Connect the Half Slim SSD to the SATA connector and fasten the 4 screws.

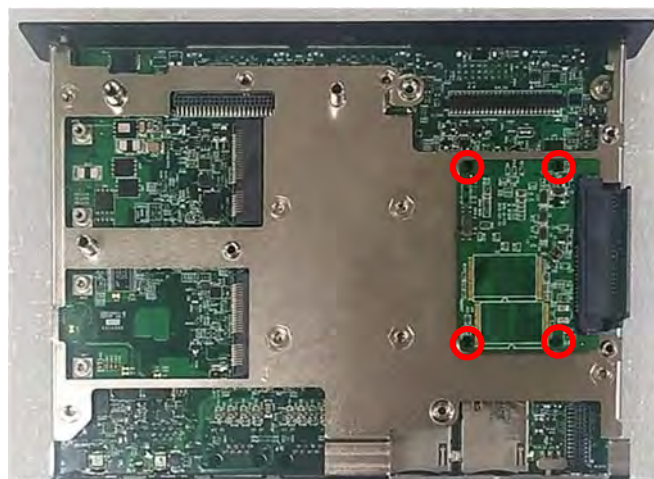

## 3.6 Installing Antennas



**CAUTION**

Please installing a Mini PCIe Wireless Lan Card on top side before you put on washer and fasten the nut with antenna jack.

1. Remove the antenna rubber covers on rear panel.



2. Have antenna jack penetrate through the hole.



3. Put on washer and fasten the nut with antenna jack.



4. Assemble the antenna and antenna jack together.



5. Attach the RF connector at another end of cable onto the module.



## 3.7 Installing CPU Heatsink Thermal Pad

1. Place the thermal pad on the CPU heatsink.

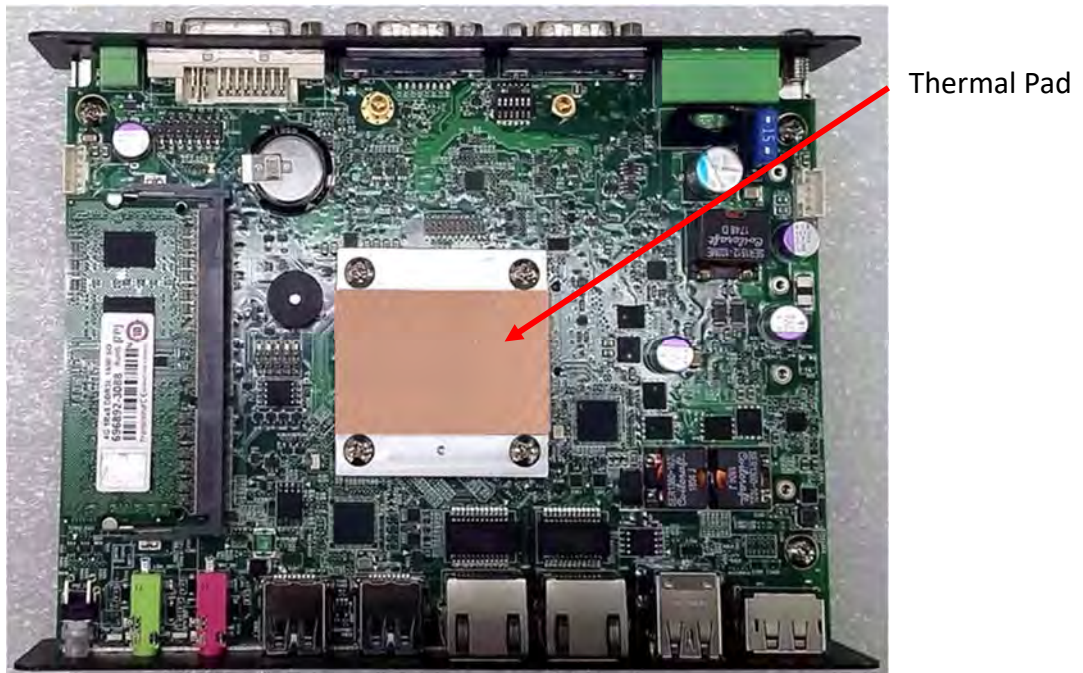

**Note: Before assembling the system's chassis cover, please make sure the protective film on the Thermal Pad has been removed!**

## 3.8 Assembling the System

1. Hold the body of unit, and make sure the both sides of front and rear panels are in the chassis grooves and insert the body of unit into chassis.



2. Level the grooves on the cover at front and rear panels. Put on the cover.



3. Fasten the 4 screws to fix the cover.



## 3.9 Installing a SIM Card

1. Loosen 2 screws on the front panel to remove the cover plate.



2. SIM card slots are at the front panel of the system.



3. Insert the SIM card.





## 3.10 Wall Mount Brackets

Spectra PowerBox 210 offers Wall Mount that customers can install system on the wall in convenient and economical way.



1. The mounting holes are at the bottom side of system. Use provided 4 screws to fasten the bracket with each side on system together.



2. Fasten the screws through the bracket mounting hole to mount system on the wall.



### 3.11 DIN-Rail Mount

Spectra PowerBox 210 offers DIN-Rail Mount that customer can install system on the DIN Rail.

1. The mounting holes are at the bottom side of system. Use provided 4 screws to fasten the bracket with each side on system together.



2. Fasten 2 DIN rail mounting clips to mounting brackets on both sides with provided 4 screws as illustrated.



3. Clip the system into DIN rail as illustrated by the following steps. (1) Have lower end of mounting clip snaps into the DIN rail. (2) Press the system toward to have upper end of mounting clip snaps into the other side of DIN rail.



# Chapter 4

## **BIOS Setup**

## 4.1 BIOS Introduction

The BIOS (Basic Input/ Output System) is a program located on a Flash Memory on the motherboard. When you start the computer, the BIOS program will gain control. The BIOS first operates an auto-diagnostic test called POST (power on self-test) for all the necessary hardware, it detects the entire hardware device and configures the parameters of the hardware synchronization.

### BIOS Setup

Power on the computer and by pressing <Del> immediately allows you to enter Setup. If the message disappears before your respond and you still wish to enter Setup, restart the system to try again by turning it OFF then ON or pressing <Ctrl>, <Alt> and <Delete> keys.

Control Keys	
<←> <→>	Move to select screen
<↑> <↓>	Move to select item
<Esc>	Quit the BIOS Setup
<Enter>	Select item
<Page Up/+>	Increases the numeric value or makes changes
<Page Down/->	Decreases the numeric value or makes changes
<Tab>	Select setup fields
<F1>	General help
<F2>	Previous value
<F3>	Load Optimized defaults
<F10>	Save configuration and Exit

### Main Menu

The main menu lists the setup functions you can make changes to. You can use the arrow keys ( ↑↓ ) to select the item. The on-line description of the highlighted setup function is displayed at the bottom of the screen.

### Sub-Menu

If you find a right pointer symbol appears to the left of certain fields that means a sub-menu can be launched from this field. A sub-menu contains additional options for a field parameter. You can use arrow keys ( ↑↓ ) to highlight the field and press <Enter> to call up the sub-menu. Then you can use the control keys to enter values and move from field to field within a sub-menu. If you want to return to the main menu, just press the <Esc >.

## 4.2 Main Setup

Press <Del> to enter BIOS CMOS Setup Utility, the Main Menu (as shown below) will appear on the screen. Use arrow keys to move among the items and press <Enter> to accept or enter a sub-menu.



### 4.2.1 System Date

Set the date. Please use <Tab> to switch between date elements.

### 4.2.2 System Time

Set the time. Please use <Tab> to switch between time elements.

## 4.3 Advanced Setup

This section allows you to configure and improve your system and allows you to set up some system features according to your preference.

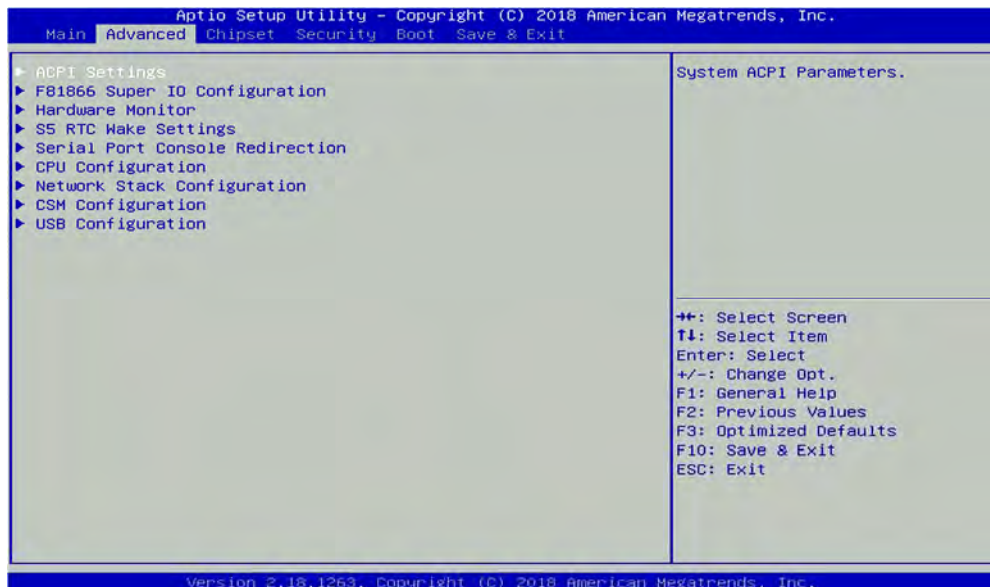

### 4.3.1 ACPI Settings

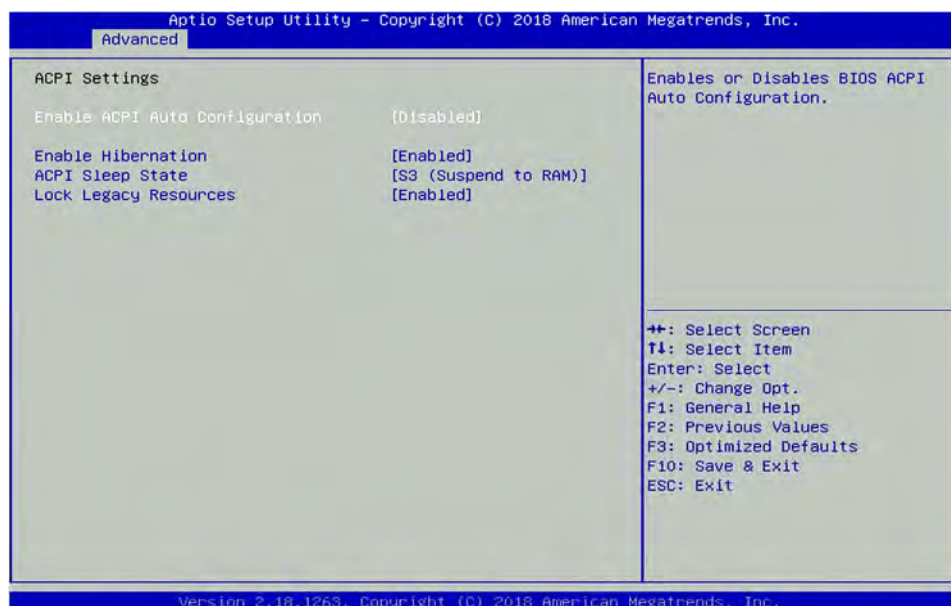

#### ■ Enable ACPI Auto Configuration [Disabled]

Enables or disables BIOS Advanced Configuration Power Interface® (ACPI) auto configuration.

#### ■ Enable Hibernation [Enabled]

Enables or disables system ability to hibernate state (OS/S4 state). This option may not be effective with some OS.

### ■ ACPI Sleep State [S3 (Suspend to RAM)]

Allows users to select the highest Advanced Configuration Power Interface® (ACPI) sleep state that system will enter when suspend button is pressed.

[Suspend Disabled]: Disables entering suspend state.

[S3 (suspend to RAM)]: Enables suspend to RAM state.

### ■ Lock Legacy Resources [Enabled]

Enables or disables Lock Legacy Resources.

### 4.3.2 F81866 Super IO Configuration

Set Parameters of Serial Ports. User can Enable/Disable the serial port and Select an optimal setting for the Super IO Device.

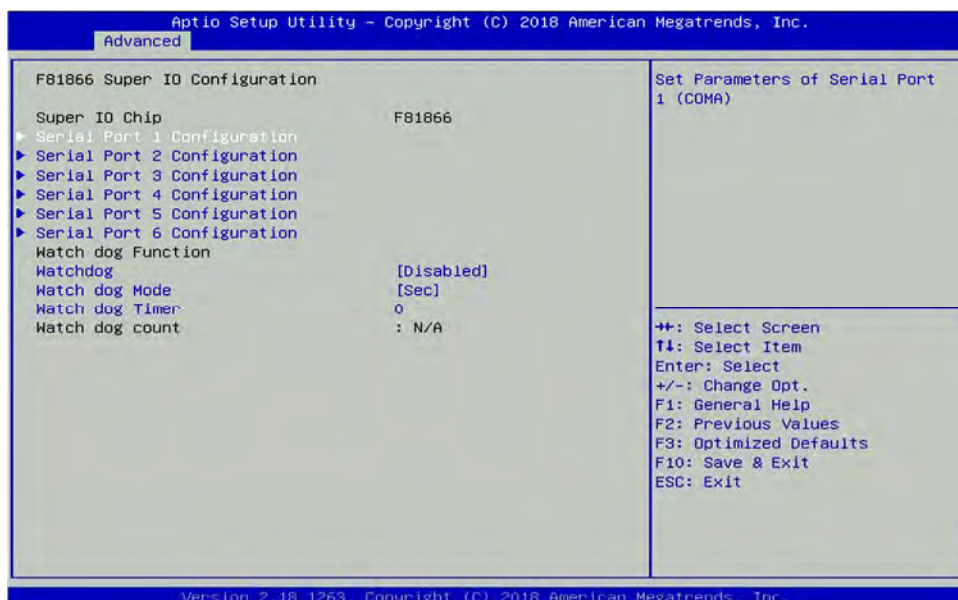

### ■ Serial Port 1~6 Configuration.

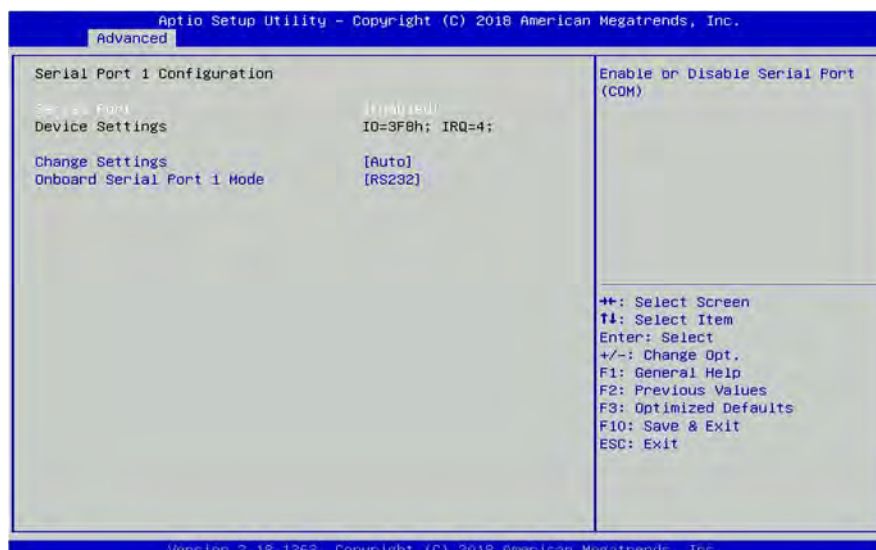

**Serial Port [Enabled]**

Enables or disables serial port.

**Change Settings [Auto]**

Allows you to change the IO Address & IRQ settings of the specified serial port.

**Onboard Serial Port 1~6 Mode [RS232]**

Allows you to select Serial Port Mode.

Configuration options: [RS232] [RS422/RS485 Full Duplex] [RS485 Half Duplex]

■ **Watch Dog [Disabled]**

Enables or disables watch dog function.

■ **Watch Dog Mode [Sec]**

Allows to set watchdog timer unit <Sec> or <Min>.

■ **Watch Dog Timer [0]**

Allows you to set watchdog timer's value in the range of 0 to 255.

**4.3.3 Hardware Monitor**

This screen displays the current status of all monitored hardware devices/components such as voltages, temperatures and all fans' speeds.

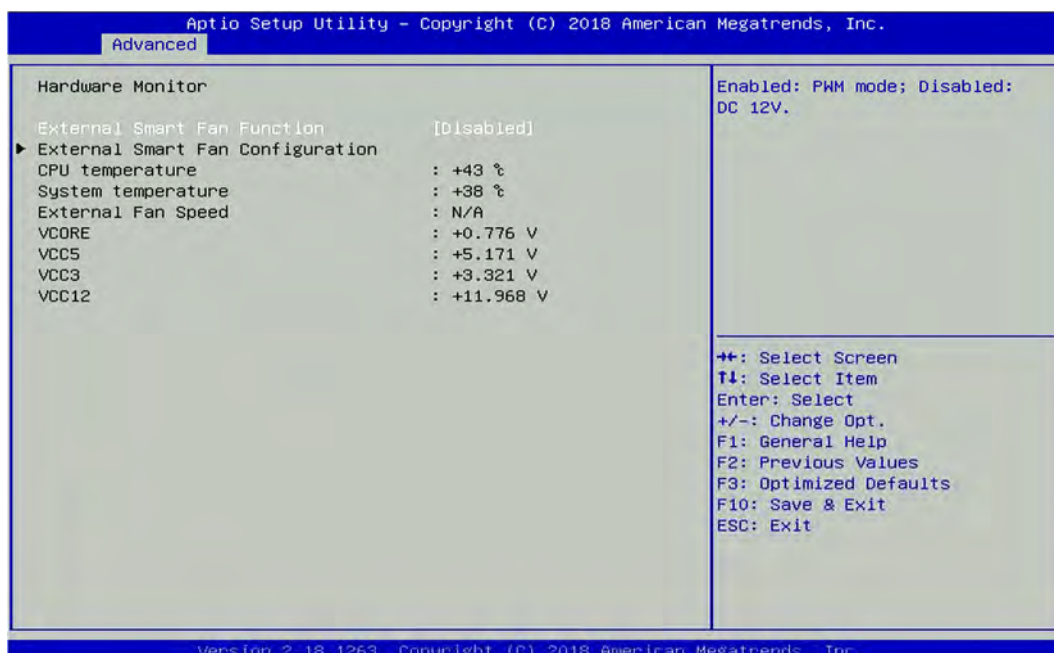



### 4.3.4 S5 RTC Wake Settings

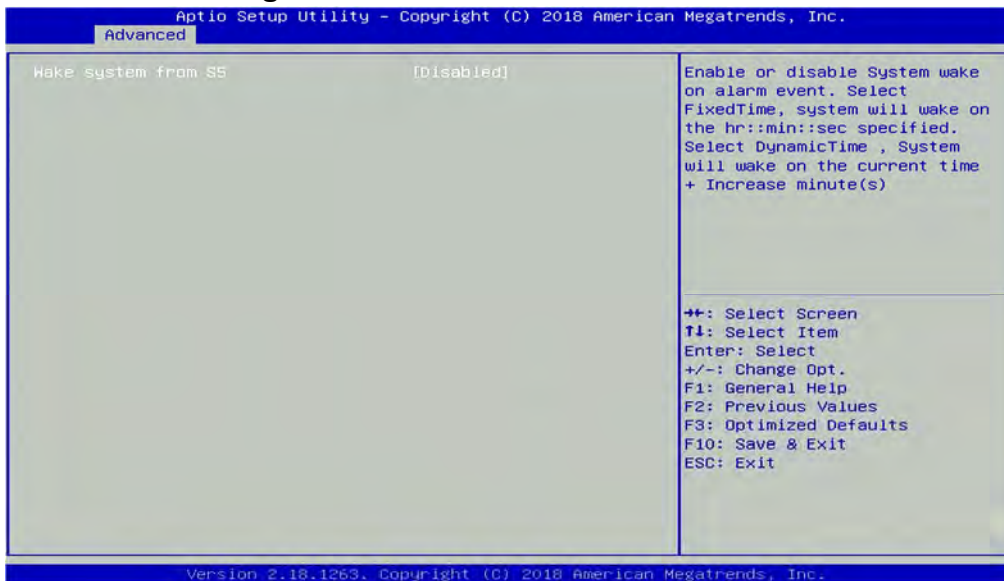

#### ■ Wake system from S5 [Disabled]

Enables or disables wake system from S5 (soft-off state).

[Disabled]: Disables wake system from S5.

[Fixed Time]: Sets a fixed time (HH:MM:SS) to wake system from S5.

[Dynamic Time]: Sets an increase minute(s) from current time to wake system from S5.

### 4.3.5 Serial Port Console Redirection

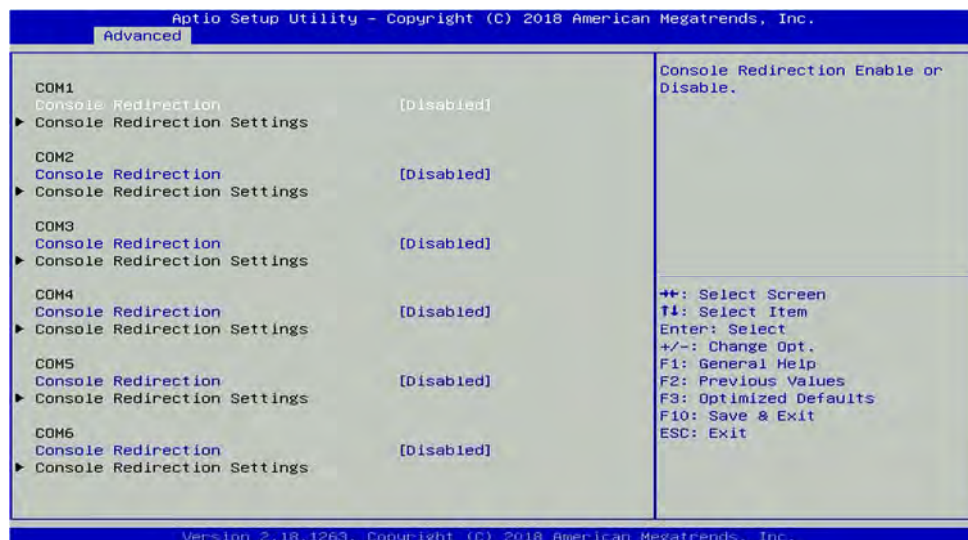

#### ■ Console Redirection [Disabled]

Allow users to enable or disable COM1, COM2, COM3, COM4, COM5, COM6 console redirection function.

### 4.3.6 CPU Configuration

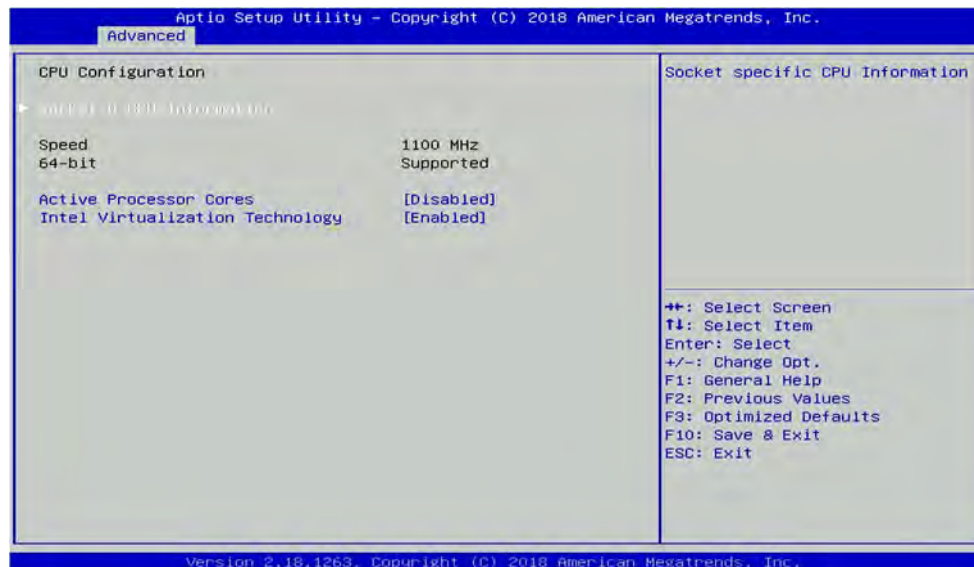

#### ■ Socket 0 CPU Information

This section provides information on your CPU, frequency, and cache memory.

#### ■ Active Processor Cores [Enabled]

Number of cores to enable in each processor package.

#### ■ Intel Virtualization Technology [Enabled]

Enables or disables Intel Virtualization Technology. Virtualization enhanced by Intel Virtualization Technology will allow a platform to run multiple operating systems and applications in independent partitions. With virtualization, one computer system can function as multiple virtual systems.

### 4.3.7 Network Stack Configuration

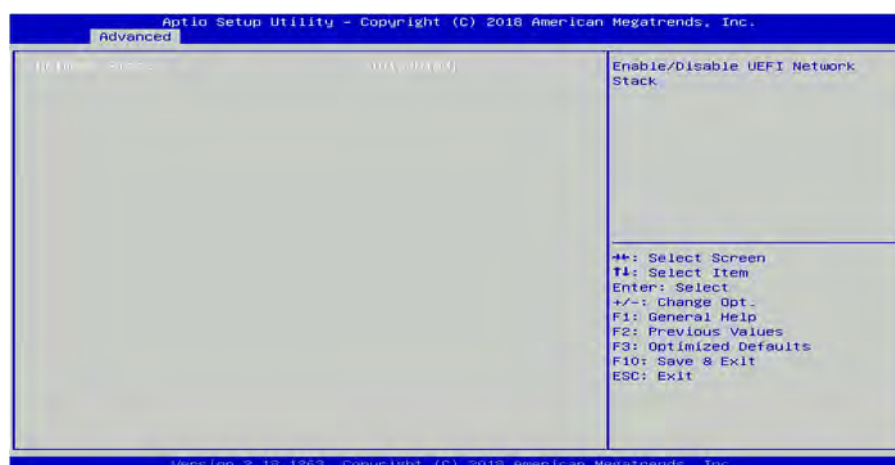

#### ■ Network Stack [Disabled]

Enables or disables UEFI Network Stack.

### 4.3.8 CSM Configuration

This option controls legacy/UEFI ROMs priority.

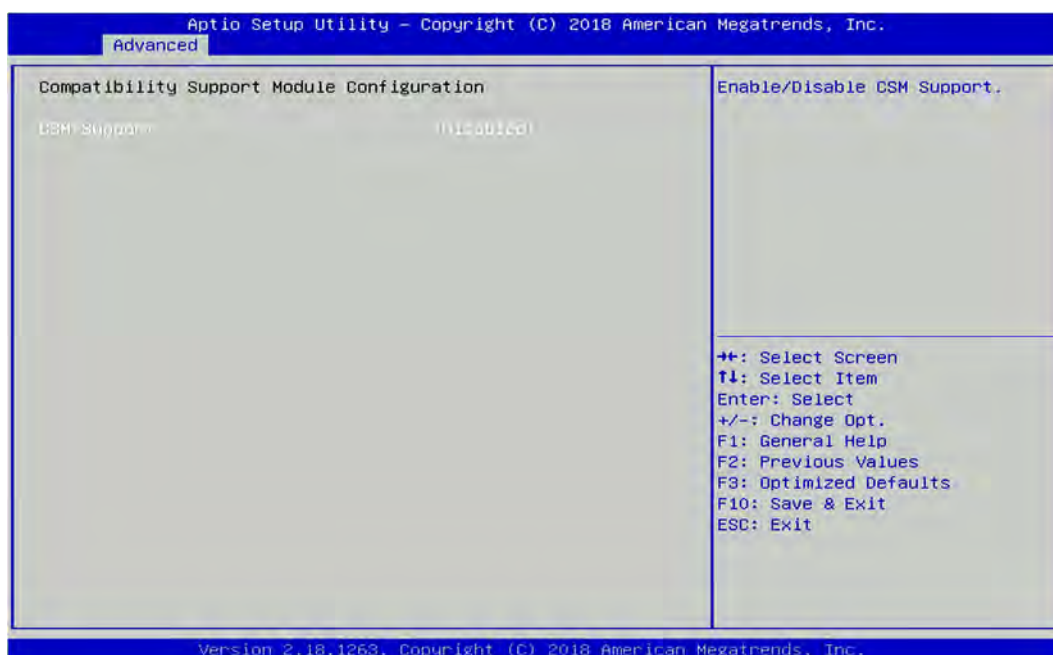

#### ■ CSM Support [Disabled]

Enables or disables compatibility support module.

#### ■ Boot option filter [UEFI and Legacy]

Allows you to select which type of operating system to boot.

[UEFI and Legacy]: Allows booting from operating systems that support legacy option ROM or UEFI option ROM.

[Legacy only]: Allows booting from operating systems that only support legacy option ROM.

[UEFI only]: Allows booting from operating systems that only support UEFI option ROM.

#### ■ Network [Do not launch]

Controls the execution of UEFI and Legacy PXE (Network Preboot eXecution Environment) option ROM.

[Do not launch]: Disables option ROM execution.

[UEFI]: Enables UEFI option ROM only.

[Legacy]: Enables legacy option ROM only.

#### ■ Storage [UEFI]

Controls the execution of UEFI and Legacy Storage option ROM.

[Do not launch]: Disables option ROM execution.

[UEFI]: Enables UEFI option ROM only.

[Legacy]: Enables legacy option ROM only.

#### ■ Video [UEFI]

Controls the execution of UEFI and Legacy Video option ROM.

[Do not launch]: Disables option ROM execution.

[UEFI]: Enables UEFI option ROM only.

[Legacy]: Enables legacy option ROM only.

#### ■ Other PCI devices [Do not launch]

Allows users to determine option ROM execution policy for device other than network, storage, or video.

### 4.3.9 USB Configuration

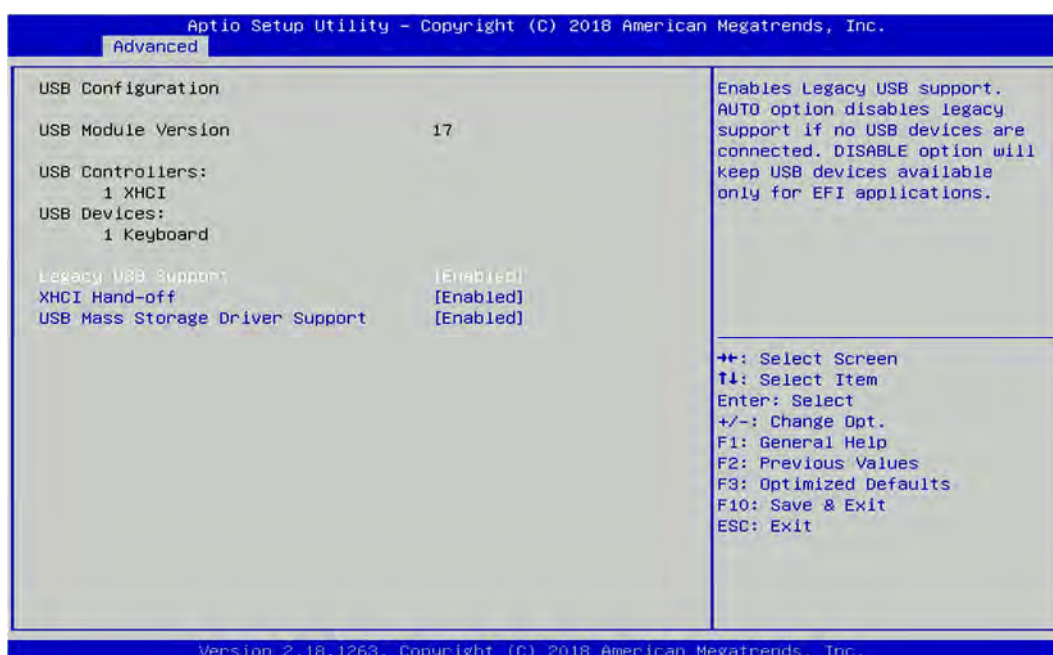

#### ■ Legacy USB Support [Enabled]

This item allows you to enable or disable legacy USB support. When set to [Auto], legacy USB support will be disabled automatically if no USB devices are connected.

#### ■ XHCI Hand-off [Enabled]

Enables or disables XHCI (USB3.0) hand-off function. Use this feature as a workaround for operating systems without XHCI hand-off support.

#### ■ USB Mass Storage Driver Support [Enabled]

Enables or disables USB mass storage driver support.

## 4.4 Chipset Setup

This section allows you to configure chipset related settings according to user's preference.

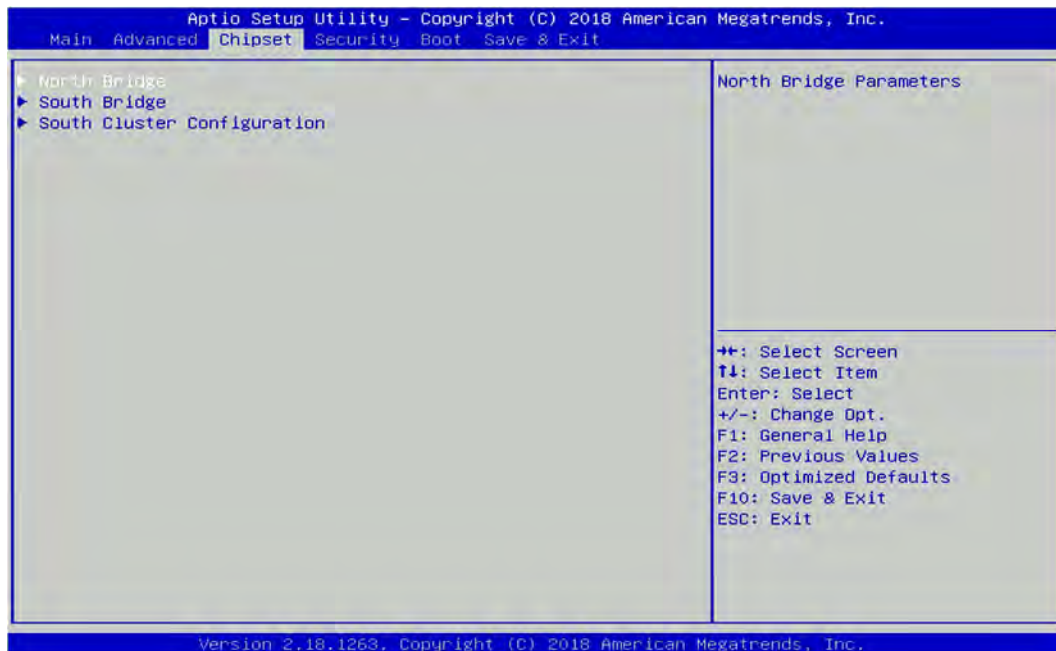

### 4.4.1 North Bridge

This section provides information on the installed memory size.

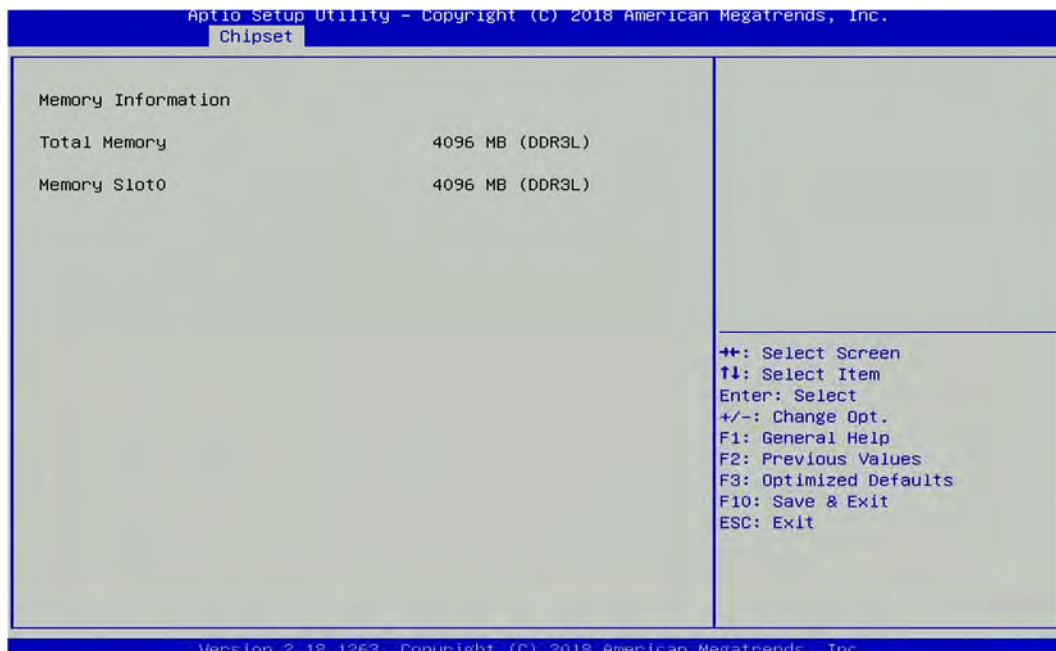

## 4.4.2 South Bridge

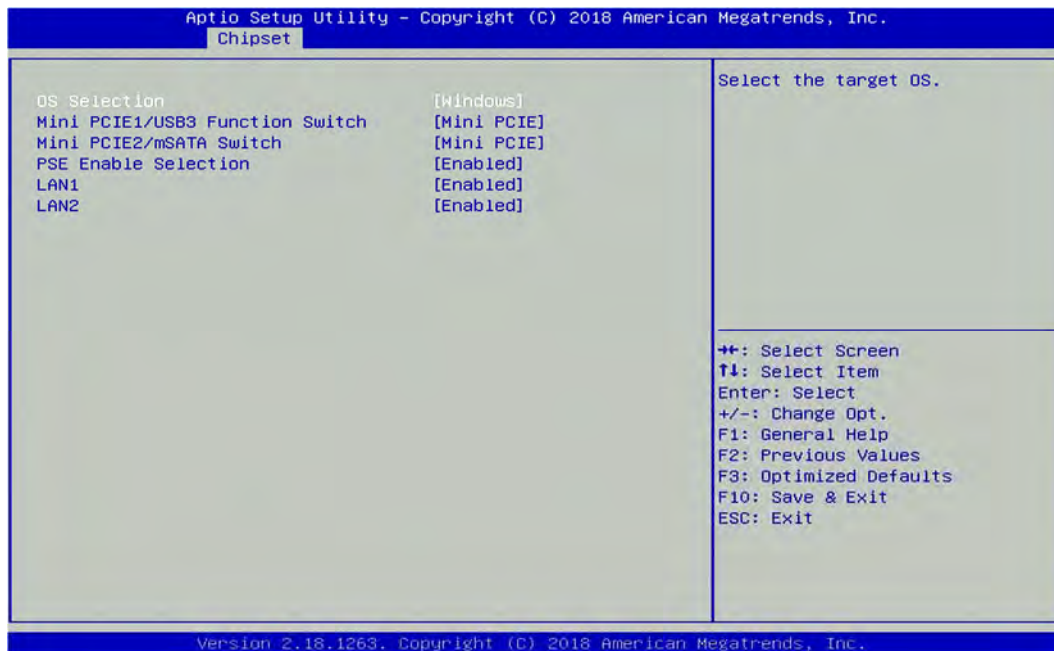

### ■ OS Selection [Windows]

Allows you to configure Operating System version to install.

Configuration options: [Windows] [Intel Linux]

### ■ Mini PCIE1/USB3 Function Switch [Mini PCIE]

Allows you to change **Mini PCIE1** to [Mini PCIE] or [USB3].

### ■ Mini PCIE2/mSATA Switch [Mini PCIE]

Allows you to change **Mini PCIE2** to [Mini PCIE] or [mSATA].

### ■ PSE Enable Selection [Enabled]

Enables or disables PSE (Power Sourcing Equipment).

### ■ LAN1 [Enabled]

Enables or disables LAN1 Controller.

### ■ LAN2 [Enabled]

Enables or disables LAN2 Controller.

## 4.4.3 South Cluster Configuration

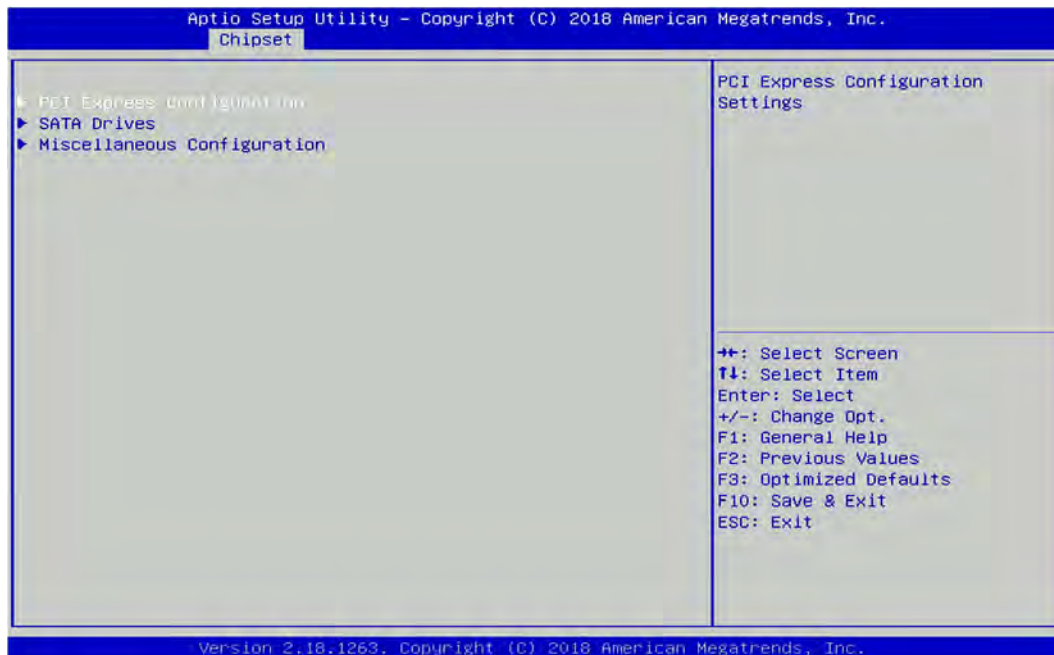

### ■ PCI Express Configuration

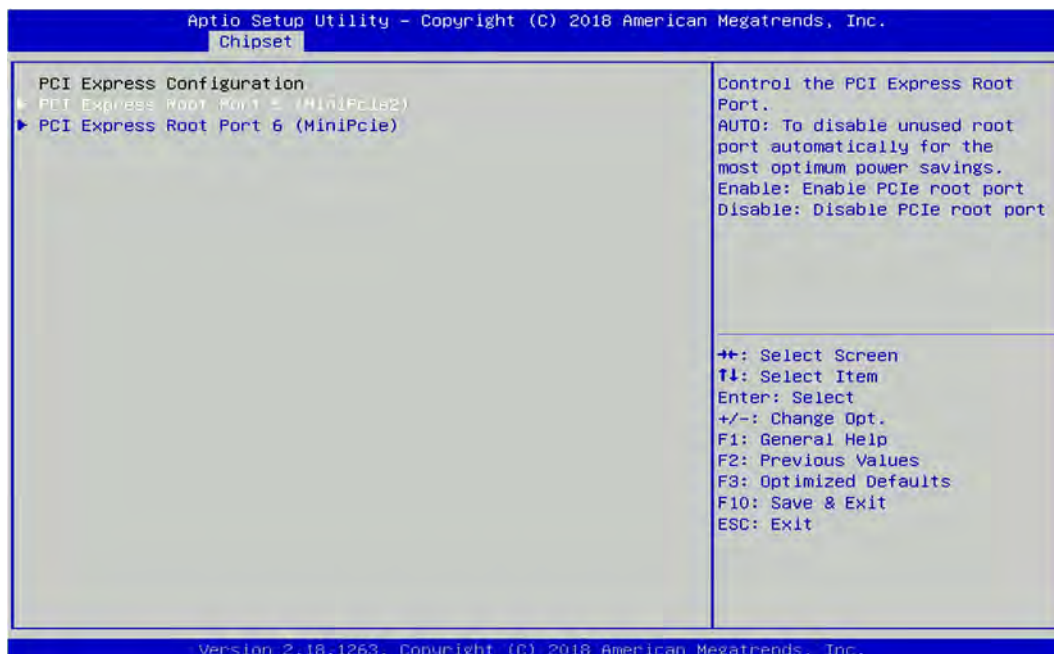

#### PCI Express Root Port 5 (MiniPcie2)

##### PCI Express Root Port 5 (MiniPcie2) [Enabled]

Enables or disables PCI Express Root Port.

##### PCIe Speed [Auto]

Allows you to select PCI Express port speed.

Configuration options: [Auto] [Gen1] [Gen2].

#### PCI Express Root Port 6 (MiniPcie)

##### PCI Express Root Port 6 (MiniPcie) [Enabled]

Enables or disables PCI Express Root Port.

**PCIe Speed [Auto]**

Allows you to select PCI Express port speed.

Configuration options: [Auto] [Gen1] [Gen2].

■ **SATA Devices**

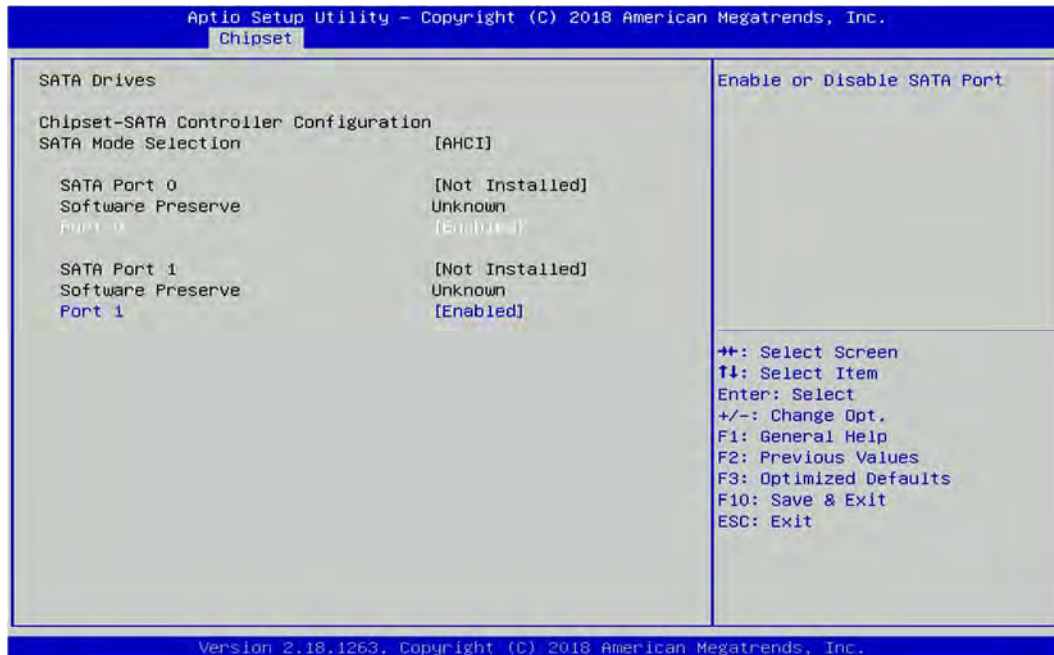

**SATA Port 0**

**Port 0 [Enabled]**

Enables or disables SATA Port 0.

**SATA Port 1**

**Port 1 [Enabled]**

Enables or disables SATA Port 1.

■ **Miscellaneous Configuration**



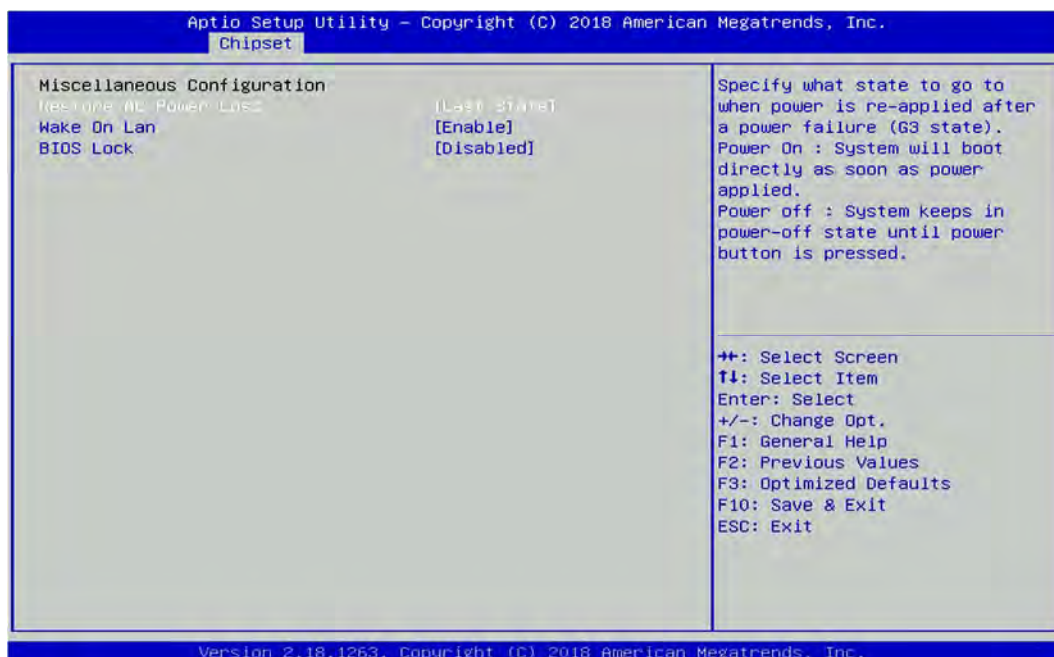

**Restore AC Power Loss [Last state]**

Allows you to specify which power state system will enter when power is resumed after a power failure (G3 state).

[Always on]: Enters to power on state.

[Always off]: Enters to power off state.

[Last state]: Enters to the last power state before a power failure occurs.

**Wake On Lan [Enabled]**

Enables or disables Wake On LAN (WOL) function.

**BIOS Lock [Disabled]**

Enables or disables BIOS the SC BIOS Lock enable feature. It is required to be enabled to ensure SMM protection of flash.

## 4.5 Security Setup

This section allows users to configure BIOS security settings.

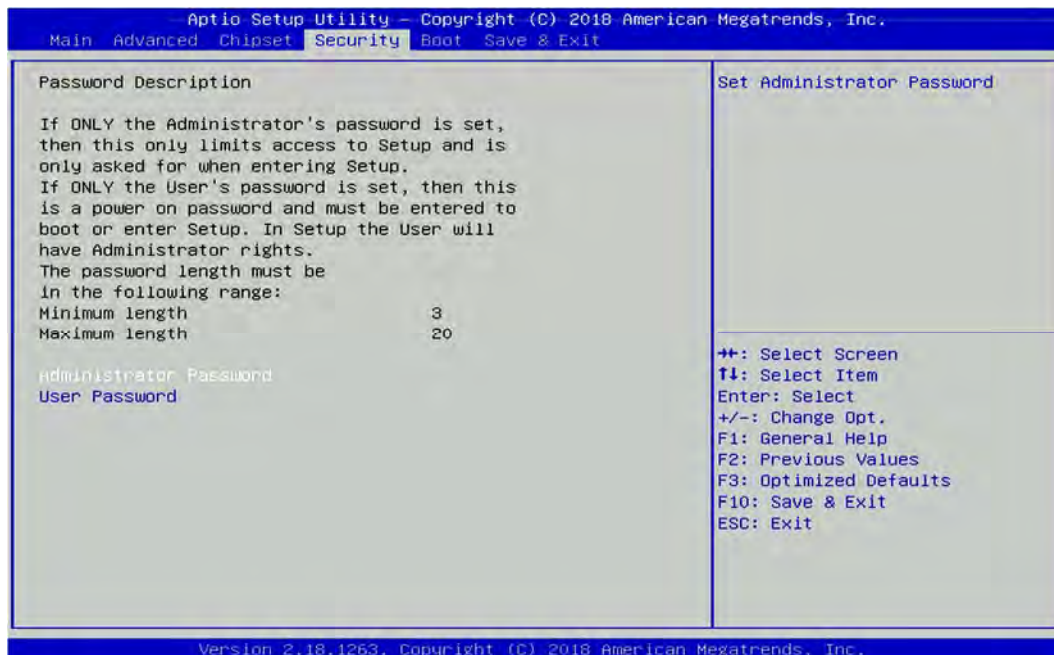

### 4.5.1 Administrator Password

Administrator Password controls access to the BIOS Setup utility.

### 4.5.2 User Password

User Password controls access to the system at boot and to the BIOS Setup utility.

## 4.6 Boot Setup

This section allows you to configure Boot settings.

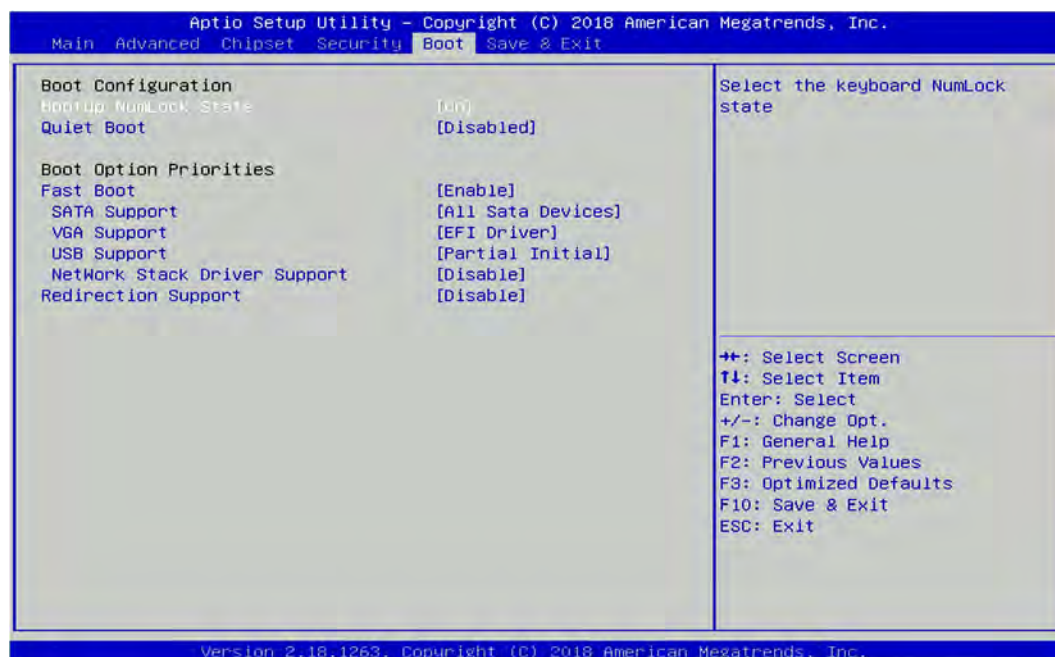

### ■ Bootup NumLock State

Allows you to set NumLock key to [On] or [Off] state when system boots up.

### ■ Quiet Boot

Allows you to enable or disable Quiet Boot function.

### ■ Fast Boot

Allows you to enable or disable Fast Boot function. If enabled, system boots with initialization of a minimal set of devices required to launch active boot option.

## 4.7 Save & Exit

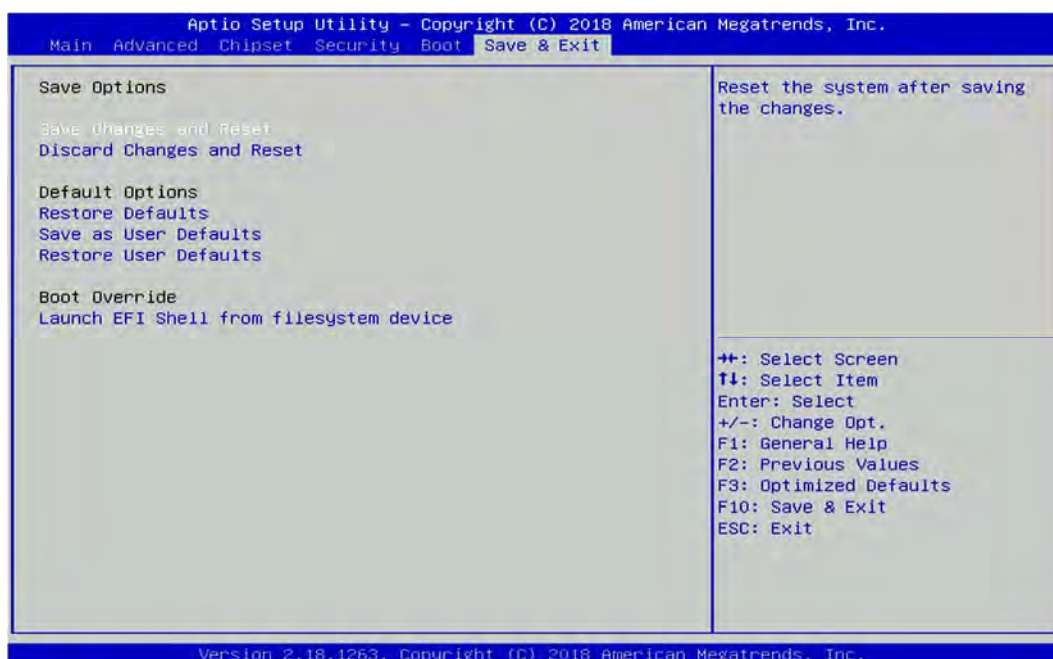

### ■ Save Changes and Reset

This item allows you to reset the system after saving changes.

### ■ Discard Changes and Reset

This item allows you to reset system setup without saving any changes.

### ■ Restore Defaults

This item allows you to restore/ load default values for all the setup options.

### ■ Save as User Defaults

This item allows you to save the changes done so far as user defaults.

### ■ Restore User Defaults

This item allows you to restore the user defaults to all the setup options.

# Chapter 5

## **Product Application**

**(For PB-210-DIO only)**

## 5.1 Digital I/O (DIO) application

This section describes DIO application of the product. The content and application development are better understood and implemented by well experienced professionals or developers.

### 5.1.1 Digital I/O Programming Guide

#### 5.1.1.1 Pins for Digital I/O

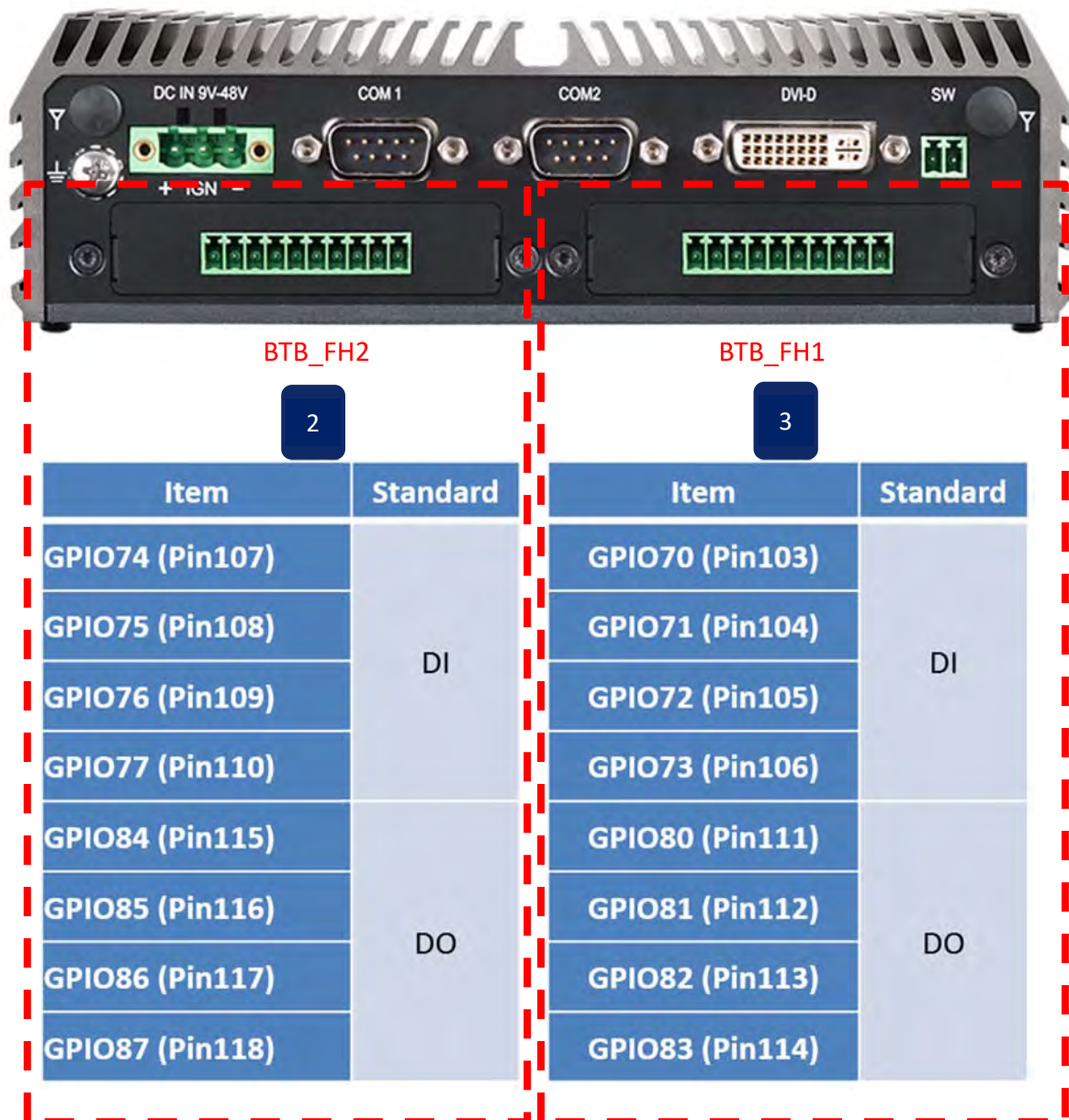

BTB\_FH2

**2**

Item	Standard
GPIO74 (Pin107)	DI
GPIO75 (Pin108)	
GPIO76 (Pin109)	
GPIO77 (Pin110)	
GPIO84 (Pin115)	DO
GPIO85 (Pin116)	
GPIO86 (Pin117)	
GPIO87 (Pin118)	

BTB\_FH1

**3**

Item	Standard
GPIO70 (Pin103)	DI
GPIO71 (Pin104)	
GPIO72 (Pin105)	
GPIO73 (Pin106)	
GPIO80 (Pin111)	DO
GPIO81 (Pin112)	
GPIO82 (Pin113)	
GPIO83 (Pin114)	

### 5.1.1.2 Programming Guide

To program the Super I/O chip F81866A configuration registers, the following configuration procedures must be followed in sequence:

- (1) Enter the Extended Function Mode
- (2) Configure the configuration registers
- (3) Exit the Extended Function Mode

The configuration register is used to control the behavior of the corresponding devices. To configure the register, use the index port to select the index and then write data port to alter the parameters. The default index port and data port are 0x4E and 0x4F, respectively.

**Pull down the SOUT1 pin to change the default value to 0x2E/ 0x2F. To enable configuration, the entry key 0x87 must be written to the index port. To disable configuration, write exit entry key 0xAA to the index port.**

Following is an example to enable configuration and to disable configuration by using debug.

- o 4e 87
- o 4e 87 (enable configuration)
- o 4e aa (disable configuration)

### 5.1.1.3 Relative Registers

To program the F81866A configuration registers, see the following configuration procedures.

Logic Device Number Register (LDN) — Index 07h

Bit	Name	R/W	Reset	Default	Description
7-0	LDN	R/W	LRESET#	00h	00h: Select FDC device configuration registers. 03h: Select Parallel Port device configuration registers. 04h: Select Hardware Monitor device configuration registers. 05h: Select KBC device configuration registers. <span style="border: 1px solid red; padding: 2px;">06h: Select GPIO device configuration registers.</span> 07h: Select WDT device configuration registers. 0Ah: Select PME, ACPI and ERP device configuration registers. 10h: Select UART1 device configuration registers. 11h: Select UART2 device configuration registers. 12h: Select UART3 device configuration registers. 13h: Select UART4 device configuration registers. 14h: Select UART5 device configuration registers. 15h: Select UART6 device configuration registers. Otherwise: Reserved.

**8.7.13.1GPIO7 Output Enable Register — Index 80h**

Bit	Name	R/W	Reset	Default	Description
7	GPIO77_OE	R/W	LRESET#	0	0: GPIO77 is in input mode. 1: GPIO77 is in output mode.
6	GPIO76_OE	R/W	LRESET#	0	0: GPIO76 is in input mode. 1: GPIO75 is in output mode.
5	GPIO75_OE	R/W	LRESET#	0	0: GPIO75 is in input mode. 1: GPIO75 is in output mode.
4	GPIO74_OE	R/W	LRESET#	0	0: GPIO74 is in input mode. 1: GPIO74 is in output mode.
3	GPIO73_OE	R/W	LRESET#	0	0: GPIO73 is in input mode. 1: GPIO73 is in output mode.
2	GPIO72_OE	R/W	LRESET#	0	0: GPIO72 is in input mode. 1: GPIO72 is in output mode.
1	GPIO71_OE	R/W	LRESET#	0	0: GPIO71 is in input mode. 1: GPIO71 is in output mode.
0	GPIO70_OE	R/W	LRESET#	0	0: GPIO70 is in input mode. 1: GPIO70 is in output mode.

**8.7.13.3GPIO7 Pin Status Register — Index 82h (This byte could be also read by base address + 3)**

Bit	Name	R/W	Reset	Default	Description
7	GPIO77_IN	R	-	-	The pin status of GPIO77/STB#.
6	GPIO76_IN	R	-	-	The pin status of GPIO76/AFD#.
5	GPIO75_IN	R	-	-	The pin status of GPIO75/ERR#.
4	GPIO74_IN	R	-	-	The pin status of GPIO74/INIT#.
3	GPIO73_IN	R	-	-	The pin status of GPIO73/SLIN#.
2	GPIO72_IN	R	-	-	The pin status of GPIO72/ACK#.
1	GPIO71_IN	R	-	-	The pin status of GPIO71/BUSY.
0	GPIO70_IN	R	-	-	The pin status of GPIO70/PE/FANCTL3/PWM_DAC3.

**8.7.14.1GPIO8 Output Enable Register — Index 88h**

Bit	Name	R/W	Reset	Default	Description
7	GPIO87_OE	R/W	LRESET#	1	0: GPIO87 is in input mode. 1: GPIO87 is in output mode.
6	GPIO86_OE	R/W	LRESET#	1	0: GPIO86 is in input mode. 1: GPIO85 is in output mode.
5	GPIO85_OE	R/W	LRESET#	1	0: GPIO85 is in input mode. 1: GPIO85 is in output mode.
4	GPIO84_OE	R/W	LRESET#	1	0: GPIO84 is in input mode. 1: GPIO84 is in output mode.
3	GPIO83_OE	R/W	LRESET#	1	0: GPIO83 is in input mode. 1: GPIO83 is in output mode.
2	GPIO82_OE	R/W	LRESET#	1	0: GPIO82 is in input mode. 1: GPIO82 is in output mode.
1	GPIO81_OE	R/W	LRESET#	1	0: GPIO81 is in input mode. 1: GPIO81 is in output mode.
0	GPIO80_OE	R/W	LRESET#	1	0: GPIO80 is in input mode. 1: GPIO80 is in output mode.



### 8.7.14.2 GPIO8 Output Data Register — Index 89h (This byte could be also written by base address + 2)

Bit	Name	R/W	Reset	Default	Description
7	GPIO87_VAL	R/W	LRESET#	1	0: GPIO87 outputs 0 when in output mode. 1: GPIO87 outputs 1 when in output mode.
6	GPIO86_VAL	R/W	LRESET#	1	0: GPIO86 outputs 0 when in output mode. 1: GPIO86 outputs 1 when in output mode.
5	GPIO85_VAL	R/W	LRESET#	1	0: GPIO85 outputs 0 when in output mode. 1: GPIO85 outputs 1 when in output mode.
4	GPIO84_VAL	R/W	LRESET#	1	0: GPIO84 outputs 0 when in output mode. 1: GPIO84 outputs 1 when in output mode.
3	GPIO83_VAL	R/W	LRESET#	1	0: GPIO83 outputs 0 when in output mode. 1: GPIO83 outputs 1 when in output mode.
2	GPIO82_VAL	R/W	LRESET#	1	0: GPIO82 outputs 0 when in output mode. 1: GPIO82 outputs 1 when in output mode.
1	GPIO81_VAL	R/W	LRESET#	1	0: GPIO81 outputs 0 when in output mode. 1: GPIO81 outputs 1 when in output mode.
0	GPIO80_VAL	R/W	LRESET#	1	0: GPIO80 outputs 0 when in output mode. 1: GPIO80 outputs 1 when in output mode.

### 8.7.3 Base Address High Register — Index 60h

Bit	Name	R/W	Reset	Default	Description
7-0	GP_BASE_ADDR_HI	R/W	LRESET#	00h	The MSB of GPIO I/O port address.

### 8.7.3.4 Base Address Low Register — Index 61h

Bit	Name	R/W	Reset	Default	Description
7-0	BASE_ADDR_LO	R/W	LRESET#	00h	<p>The LSB of KBC data port address. When GPIO_DEC_RANGE is “0”, only 8 bytes are decoded:</p> <p>Base + 0: index port.            Base + 1: data port.            Base + 2: GPIO8 data register.            Base + 3: GPIO7 data register.            Base + 4: GPIO6 data register.            Base + 5: GPIO5 data register.            Base + 6: GPIO0 data register.            Base + 7: GPIO1 data register.</p> <p>If GPIO_DEC_RANGE is set to “1”, more 8 bytes are decoded:</p> <p>Base + 8: GPIO2 data register.            Base + 9: GPIO3 data register.            Base + 10: GPIO4 data register.</p> <p>Otherwise: Reserved.</p> <p>There are three ways to access the GPIO registers.</p> <ol style="list-style-type: none"> <li>1. Use configuration register port 0x4E/0x4F (or 0x2E/0x2F), the LDN for GPIO is 0x06.</li> <li>2. Use GPIO index/data port. Write index to index port first and then read/write the register.</li> <li>3. Use digital I/O port. The way only access GPIO data register. Write data to this port will control the data output register. And read this port will read the pin status register.</li> </ol>

### 5.1.1.4 Sample Code in C Language

#### 5.1.1.4.1 Control of GP70 to GP73 (DI1 ~ DI4) (BTB\_FH1)

```

#define AddrPort 0x4E
#define DataPort 0x4F

<Enter the Extended Function Mode>
WriteByte(AddrPort, 0x87)
WriteByte(AddrPort, 0x87)           // Must write twice to enter Extended mode

<Select Logic Device>
WriteByte(AddrPort, 0x07)
WriteByte(DataPort, 0x06)         // Select logic device 06h

<Output/Input Mode Selection>    // Set GP70 to GP73 input Mode
WriteByte(AddrPort, 0x80)        // Select configuration register 80h
WriteByte(DataPort, 0x0X)        // Set (bit 0~3) = 0 to select GP 70~73 as Input mode.

<Input Value>
WriteByte(AddrPort, 0x82)        // Select configuration register 82h
ReadByte(DataPort, Value)       // Read bit 0~3 (0xFx)= GP70 ~73 as High.

<Leave the Extended Function Mode>
WriteByte(AddrPort, 0xAA)

```

#### 5.1.1.4.2 Control of GP80 to GP83 (DO1 ~ DO4) (BTB\_FH1)

```

#define AddrPort 0x4E
#define DataPort 0x4F

<Enter the Extended Function Mode>
WriteByte(AddrPort, 0x87)
WriteByte(AddrPort, 0x87)       // Must write twice to enter Extended mode

<Select Logic Device>
WriteByte(AddrPort, 0x07)
WriteByte(DataPort, 0x06)       // Select logic device 06h

<Output/Input Mode Selection>    // Set GP80 to GP83 output Mode
WriteByte(AddrPort, 0x88)        // Select configuration register 88h
WriteByte(DataPort, 0xFF)        // Set (bit 0~3) = 1 to select GP 80 ~83 as Output
mode.

```

<Output Value>

```
WriteByte(AddrPort, 0x89) // Select configuration register 89h
WriteByte(DataPort, Value) // Set bit 0~3=(0/1) to output GP 80~83 as Low or High
```

<Leave the Extended Function Mode>

```
WriteByte(AddrPort, 0xAA)
```

#### 5.1.1.4.3 Control of GP74 to GP77 (DI1 ~ DI4) (BTB\_FH2)

```
#define AddrPort 0x4E
```

```
#define DataPort 0x4F
```

<Enter the Extended Function Mode>

```
WriteByte(AddrPort, 0x87)
WriteByte(AddrPort, 0x87) // Must write twice to entering Extended mode
```

<Select Logic Device>

```
WriteByte(AddrPort, 0x07)
WriteByte(dataPort, 0x06) // Select logic device 06h
```

<Input Mode Selection>

```
WriteByte(AddrPort, 0x80) // Set GP74 to GP77 input Mode
WriteByte(DataPort, 0x0X) // Select configuration register 80h
// Set (bit 4~7) = 0 to select GP 74~77 as Input mode
```

<input Value>

```
WriteByte(AddrPort, 0x82) // Select configuration register 82h
ReadByte(DataPort, Value) // Read bit 4~7(0xFx)= GP74~77 as High
```

<Leave the Extended Function Mode>

```
WriteByte(AddrPort, 0xAA)
```

#### 5.1.1.4.4 Control of GP84 to GP87 (DO1 ~ DO4) (BTB\_FH2)

```

#define AddrPort 0x4E
#define DataPort 0x4F

<Enter the Extended Function Mode>
WriteByte(AddrPort, 0x87)
WriteByte(AddrPort, 0x87)           // Must write twice to entering Extended mode

<Select Logic Device>
WriteByte(AddrPort, 0x07)
WriteByte(DataPort, 0x06)         // Select logic device 06h

<Output Mode Selection>           // Set GP84 to GP87 output Mode
WriteByte(AddrPort, 0x88)         // Select configuration register 88h
WriteByte(DataPort, (0xFF))       // Set (bit 4~7) = 1 to select GP 84~87 as Output mode

<Output Value>
WriteByte(AddrPort, 0x89)         // Select configuration register 89h
WriteByte(DataPort, Value)       // Set bit 4~7=(0/1) to output GP 84~87 as Low or High

<Leave the Extended Function Mode>
WriteByte(AddrPort, 0xAA)

```

#### 5.1.1.4.5 Control of GP70 to GP77 (DI1 ~ DI8) (BTB\_FH1 & BTB\_FH2)

```

#define AddrPort 0x4E
#define DataPort 0x4F

<Enter the Extended Function Mode>
WriteByte(AddrPort, 0x87)
WriteByte(AddrPort, 0x87)           // Must write twice to entering Extended mode

<Select Logic Device>
WriteByte(AddrPort, 0x07)
WriteByte(dataPort, 0x06)         // Select logic device 06h

<Input Mode Selection>           // Set GP70 to GP77 input Mode
WriteByte(AddrPort, 0x80)         // Select configuration register 80h
WriteByte(DataPort, 0x0X)       // Set (bit 0~7) = 0 to select GP 70~77 as Input mode

```

```

<input Value>
WriteByte(AddrPort, 0x82)           // Select configuration register 82h
ReadByte(DataPort, Value)          // Read bit 0~7(0xFx)= GP70~77 as High

```

```

<Leave the Extended Function Mode>
WriteByte(AddrPort, 0xAA)

```

#### 5.1.1.4.6 Control of GP80 to GP87 (DO1 ~ DO8) (BTB\_FH1 & BTB\_FH2)

```

#define AddrPort 0x4E
#define DataPort 0x4F

```

```

<Enter the Extended Function Mode>
WriteByte(AddrPort, 0x87)
WriteByte(AddrPort, 0x87)          // Must write twice to entering Extended mode

```

```

<Select Logic Device>
WriteByte(AddrPort, 0x07)
WriteByte(dataPort, 0x06)          // Select logic device 06h

```

```

<Input Mode Selection>             // Set GP80 to GP87 input Mode
WriteByte(AddrPort, 0x88)          // Select configuration register 88h
WriteByte(DataPort, 0xFF)          // Set (bit 0~7) = 1 to select GP 80~87 as Input mode

```

```

<input Value>
WriteByte(AddrPort, 0x89)          // Select configuration register 89h
ReadByte(DataPort, Value)          // Read bit 0~7(0/1)= GP80~87 as High

```

```

<Leave the Extended Function Mode>
WriteByte(AddrPort, 0xAA)

```

#### 5.1.1.4.7 Change base address

```

<Enter the Extended Function Mode>
WriteByte(AddrPort, 0x87)
WriteByte(AddrPort, 0x87)          // Must write twice to enter Extended mode

```

```

<Select Logic Device>
WriteByte(AddrPort, 0x07)
WriteByte(dataPort, 0x06)          // Select logic device 06h

```

```

WriteByte(AddrPort, 0x60)          // Select configuration register 60h (High Byte address)

```

```
WriteByte(DataPort, (0x0A))
```

```
WriteByte(AddrPort, 0x61) // Select configuration register 61h (Low Byte address)
```

```
WriteByte(DataPort, (0x00))
```

<Leave the Extended Function Mode>

```
WriteByte(AddrPort, 0xAA)
```

Spectra default DIO Port base address is set to 0x0A00h

### 5.1.1.5 DATA Bit Table (DIO)

7	6	5	4	3	2	1	0	bit
0	0	0	0	0	0	0	1	Value
1								/h

= DI1  
(Base address +3)  
(0xA03)

7	6	5	4	3	2	1	0	bit
0	0	0	0	0	0	0	1	Value
1								/h

= DO1  
(Base address +2)  
(0xA02)

7	6	5	4	3	2	1	0	bit
0	0	0	0	0	0	1	0	Value
2								/h

= DI2  
(Base address +3)  
(0xA03)

7	6	5	4	3	2	1	0	bit
0	0	0	0	0	0	1	0	Value
2								/h

= DO2  
Base address +2) (0xA02)

7	6	5	4	3	2	1	0	bit
0	0	0	0	0	1	0	0	Value
4								/h

= DI3  
(Base address +3)  
(0xA03)

7	6	5	4	3	2	1	0	bit
0	0	0	0	0	1	0	0	Value
4								/h

= DO3  
Base address +2) (0xA02)

7	6	5	4	3	2	1	0	bit
0	0	0	0	1	0	0	0	Value
8								/h

= DI4  
(Base address +3)  
(0xA03)

7	6	5	4	3	2	1	0	bit
0	0	0	0	1	0	0	0	Value
8								/h

= DO4  
Base address +2) (0xA02)

7	6	5	4	3	2	1	0	bit
0	0	0	1	0	0	0	0	Value
10								/h

= DI5  
(Base address +3)  
(0xA03)

7	6	5	4	3	2	1	0	bit
0	0	0	1	0	0	0	0	Value
10								/h

= DO5  
Base address +2) (0xA02)

7	6	5	4	3	2	1	0	bit
0	0	1	0	0	0	0	0	Value
20								/h

= DI6  
(Base address +3)  
(0xA03)

7	6	5	4	3	2	1	0	bit
0	0	1	0	0	0	0	0	Value
20								/h

= DO6  
Base address +2) (0xA02)

7	6	5	4	3	2	1	0	bit
0	1	0	0	0	0	0	0	Value
40								/h

= DI7  
(Base address +3)  
(0xA03)

7	6	5	4	3	2	1	0	bit
0	1	0	0	0	0	0	0	Value
40								/h

= DO7  
Base address +2) (0xA02)

7	6	5	4	3	2	1	0	bit
1	0	0	0	0	0	0	0	Value
80								/h

= DI8  
(Base address +3)  
(0xA03)

7	6	5	4	3	2	1	0	bit
1	0	0	0	0	0	0	0	Value
80								/h

= DO8  
Base address +2) (0xA02)

### 5.1.1.6 DIO I/O Port Address (Default Address 0xA00)

Pin Definition	DI8	DI7	DI6	DI5	DI4	DI3	DI2	DI1
Data Bits	7	6	5	4	3	2	1	0
DIO	Digital Input							
I/O Port Address	0xA03							

Pin Definition	DO8	DO7	DO6	DO5	DO4	DO3	DO2	DO1
Data Bits	7	6	5	4	3	2	1	0
DIO	Digital Output							
I/O Port Address	0xA02							



## 5.2 DIO Hardware Specification

- XCOM+ / 2XCOM+: Isolated power in V+
- XCOM- / 2XCOM-: Isolated power in V-
- Isolated power in DC voltage: 9~30V
- 4x / 8x Digital Input (Source Type)
- Input Signal Voltage Level
  - Signal Logic 0: XCOM+ = 9V,  $\text{Signal Low} - V_- < 1V$   
XCOM+ > 9V,  $V_+ - \text{Signal Low} > 8V$
  - Signal Logic 1:  $> \text{XCOM+} - 3V$
- Input Driving Sink Current:
  - Minimal: 1 mA
  - Normal: 5 mA
- 4x / 8x Digital Output (Open Drain)
  - DO Signal have to pull up resistor to XCOM+ for external device, the resistance will affect the pull up current
  - Signal High Level: Pull up resistor to XCOM+
  - Signal Low Level: = XCOM-
  - Sink Current: 1A (Max)

## 5.2.1 DIO Connector Definition

### 5.2.1.1 BTB\_FH1



#### DIO1: Digital Input / Output Connector

Connector Type: Terminal Block 1X10 10-pin, 3.5mm pitch

Pin	Definition	Pin	Definition
1	XCOM+ (DC INPUT)	11	DO1
2	DI1	12	DO2
3	DI2	13	DO3
4	DI3	14	DO4
5	DI4	15	XCOM- (GND)

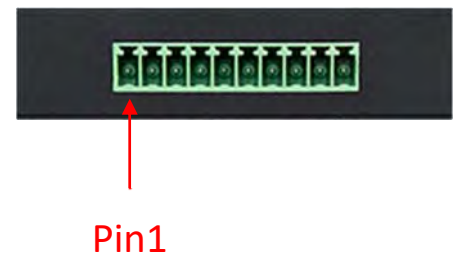

### 5.2.1.2 BTB\_FH2



#### DIO1: Digital Input / Output Connector

Connector Type: Terminal Block 1X10 10-pin, 3.5mm pitch

Pin	Definition	Pin	Definition
1	XCOM+ (DC INPUT)	11	DO1
2	DI1	12	DO2
3	DI2	13	DO3
4	DI3	14	DO4
5	DI4	15	XCOM- (GND)

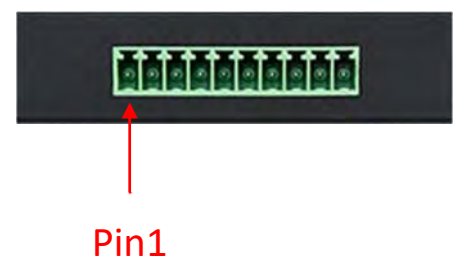

### 5.2.1.3 BTB\_FH1 & BTB\_FH2

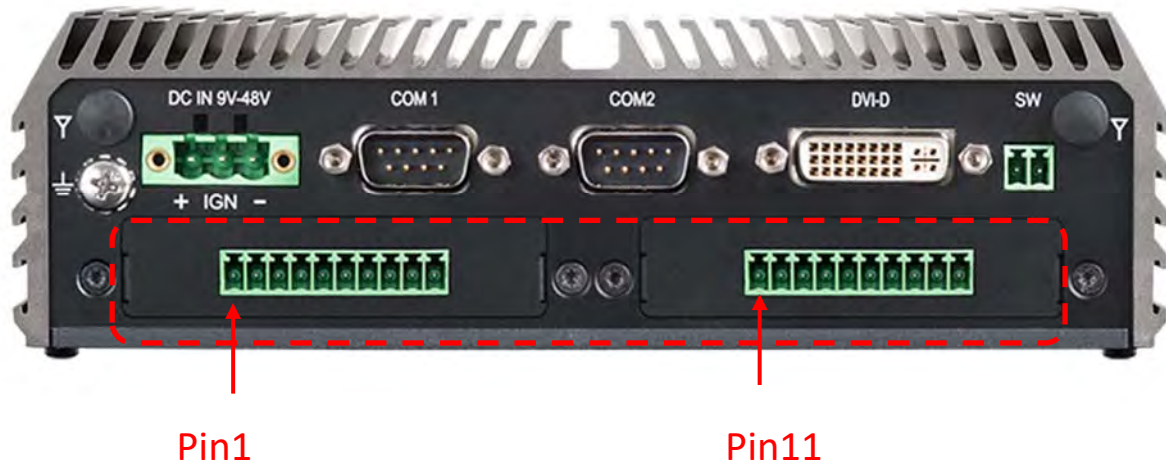

#### DIO1: Digital Input / Output Connector

Connector Type: Terminal Block 1X10 10-pin, 3.5mm pitch

Pin	Definition	Pin	Definition	Pin	Definition	Pin	Definition
1	XCOM+ (DC INPUT)	6	DO1	11	XCOM+ (DC INPUT)	16	DO1 (DO5)
2	DI1	7	DO2	12	DI1 (DI5)	17	DO2 (DO6)
3	DI2	8	DO3	13	DI2 (DI6)	18	DO3 (DO7)
4	DI3	9	DO4	14	DI3 (DI7)	19	DO4 (DO8)
5	DI4	10	XCOM- (GND)	15	DI4 (DI8)	20	XCOM- (GND)

### Reference Input Circuit

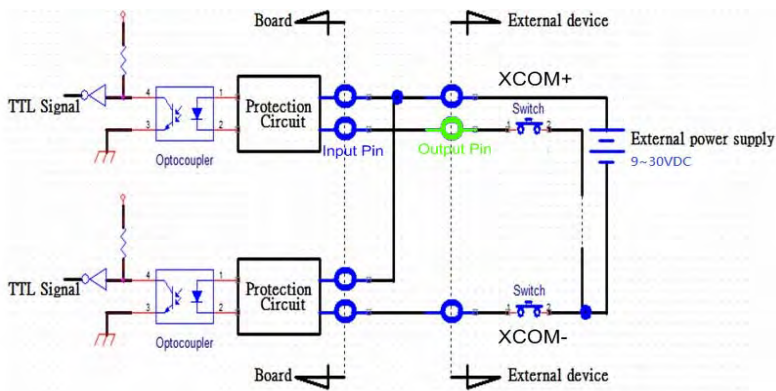

Digital Input Wiring

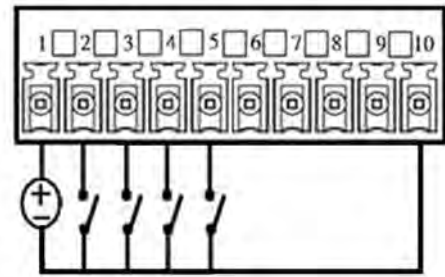

### Reference Output Circuit

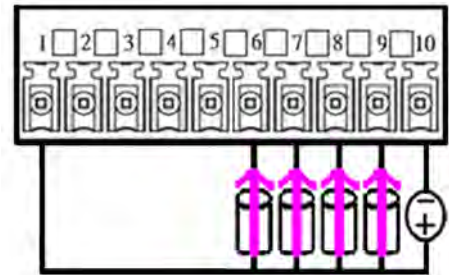
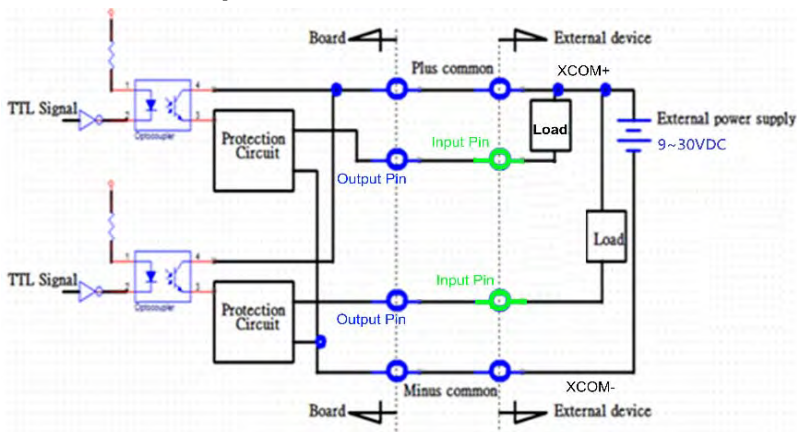

# Chapter 6

## **Optional Modules and Accessories**

### **Pin Definitions and Settings**

## 6.1 Location of the Connectors for CMI Modules

Model No.	Product Description
PB-210-DVI	CMI Module with 1x DVI-D Connector, 1x Universal Bracket with 1x DVI-D Cutout
PB-210-VGA	CMI Module with 1x VGA Port, 1x Universal Bracket with 1x VGA Cutout
PB-210-HD	CMI Module with 1x HDMI Port, 1x Universal Bracket with 1x HDMI Cutout

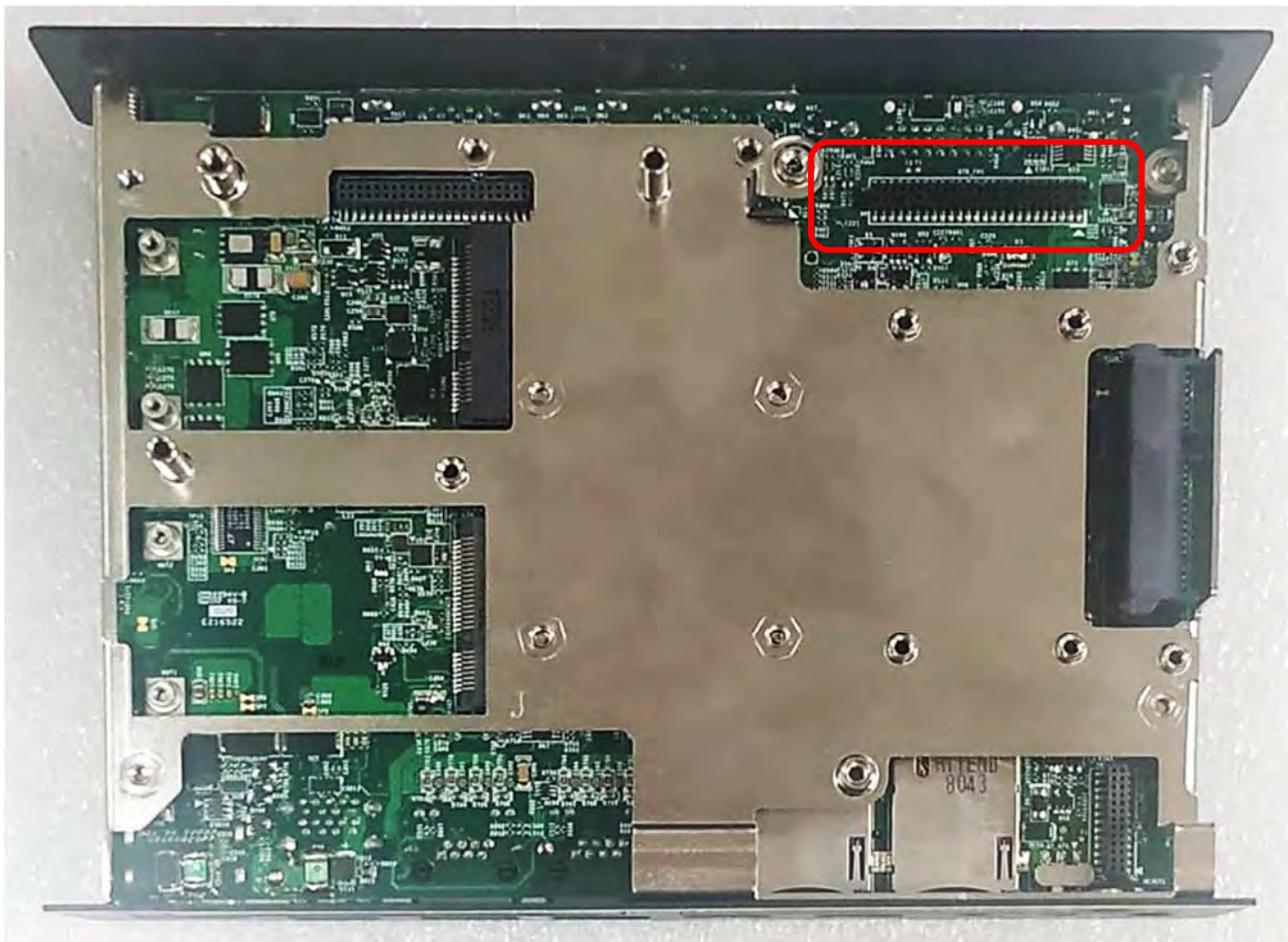

Locate the CMI Modules/ connectors on system motherboard as indicated.

Model No.	Product Description
PB-210-COM	CMI Module with 2x RS232/422/485 (Support 5V/12V), 1x Universal Bracket with 2x DB9 Cutout
PB-210-DIO	CMI Module with 8x Optical Isolated DIO (4 in/4 out), 1x Universal Bracket with DIO Cutout

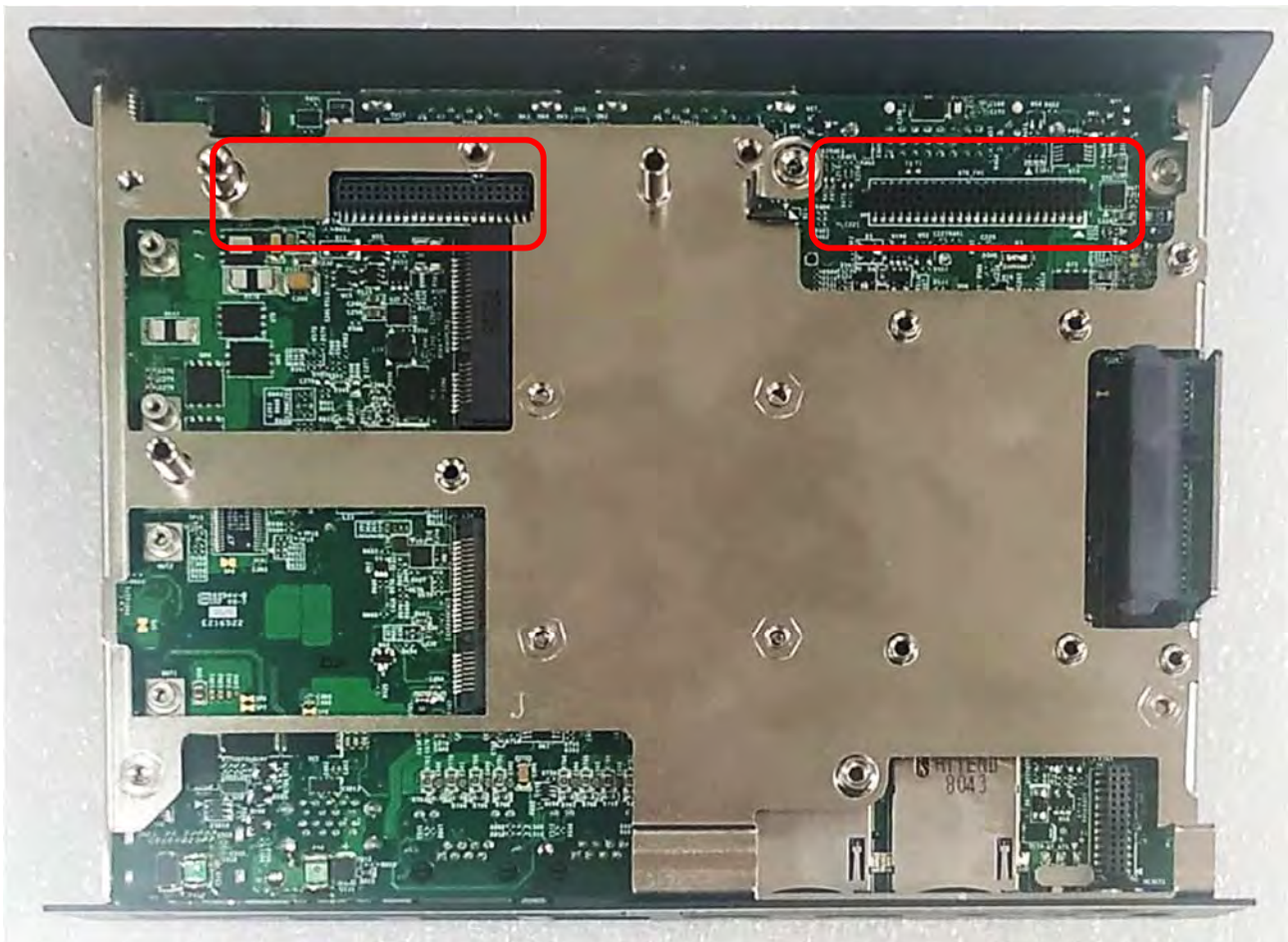

Locate the CMI Modules/ connectors on system motherboard as indicated.

## 6.2 Location of the Connector for PB-210-IGN Module

Model No.	Product Description
PB-210-IGN	CFM Module with Power Ignition Sensing Control Function, Select 12V/24V

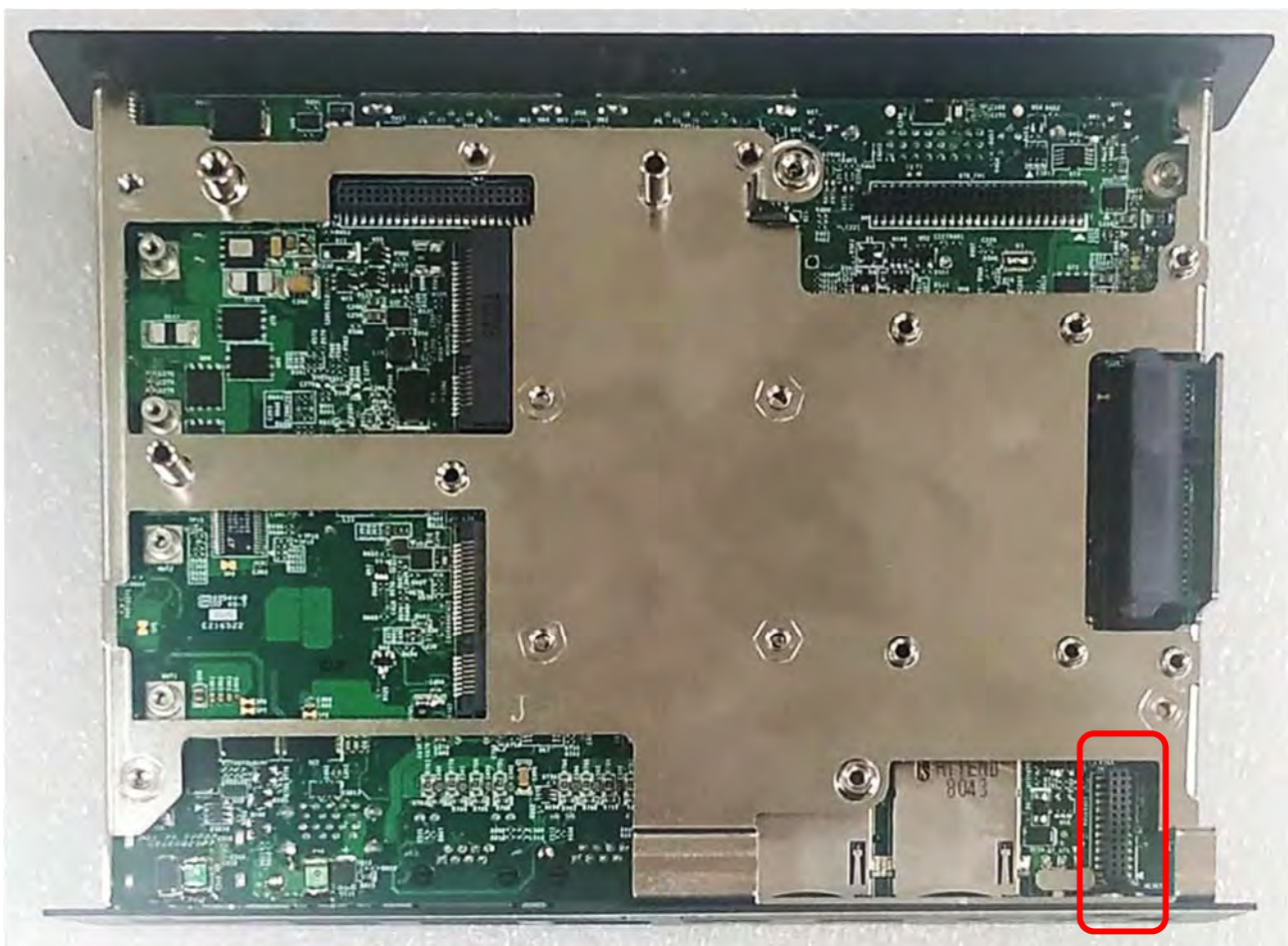

Locate the CFM-IGN Module's connector on system motherboard as indicated.



## 6.3 Location of the Connector for PB-210-PoE Module

Model No.	Product Description
PB-210-PoE	CFM Module with PoE Control Function, Individual Port 25.5W



Locate the CFM-PoE Module's connector on system motherboard as indicated.

## 6.4 CMI-COM Connector Definition and Settings

Model No.	Product Description
PB-210-COM	CMI Module with 2x RS232/422/485 (Support 5V/12V), 1x Universal Bracket with 2x DB9 Cutout

### COM3/COM4/COM5/COM6: RS232 / RS422 / RS485 Connector

Connector Type: 9-pin D-Sub

Pin	RS232 Definition	RS422 / 485 Full Duplex Definition	RS485 Half Duplex Definition
1	DCD	TX-	DATA -
2	RXD	TX+	DATA +
3	TXD	RX+	
4	DTR	RX-	
5	GND		
6	DSR		
7	RTS		
8	CTS		
9	RI		

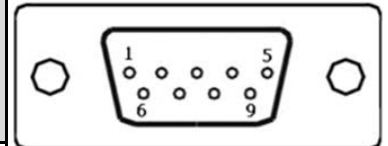

### SW1 on CMI-COM Module: COM3~4 with Power Select Switch

Function Setting via DIP Switch

Location	Function	DIP1	DIP2
SW1 on CMI-COM Module	COM3_1	0V(RI)	ON (Default)
		5V	ON
		12V	OFF

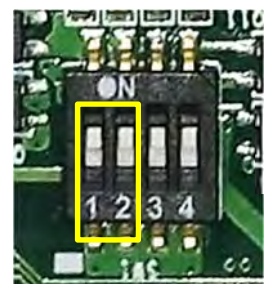

ON  
OFF

Location	Function	DIP3	DIP4
SW1 on CMI-COM Module	COM4_1	0V(RI)	ON (Default)
		5V	ON
		12V	OFF

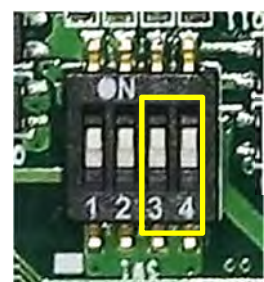

ON  
OFF

### SW1 on CMI-COM Module: COM5~6 with Power Select Switch

Function Setting via DIP Switch

Location	Function		DIP1	DIP2
SW1 on CMI-COM Module	COM5_1	0V(RI)	ON (Default)	ON (Default)
		5V	ON	OFF
		12V	OFF	OFF

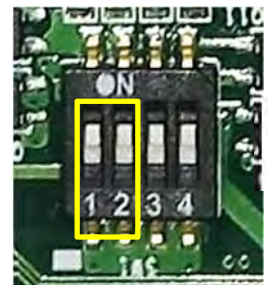

ON  
OFF

Location	Function		DIP3	DIP4
SW1 on CMI-COM Module	COM6_1	0V(RI)	ON (Default)	ON (Default)
		5V	ON	OFF
		12V	OFF	OFF

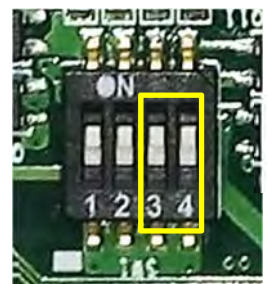

ON  
OFF

## 6.5 PB-210-IGN Switches Definition and Settings

Model No.	Product Description
PB-210-IGN	CFM Module with Power Ignition Sensing Control Function, Select 12V/24V

### SW2 on CFM-IGN Module: IGN Module Timing Setting Switch

Set shutdown delay timer when ACC is turned off

Pin 1	Definition	Pin 2	Pin 3	Pin 4	Definition
ON	IGN enabled	ON	ON	ON	0 second
		ON	ON	OFF	1 minute
		ON	OFF	ON	5 minutes
		ON	OFF	OFF	10 minutes
OFF	IGN disabled	OFF	ON	ON	30 minutes
		OFF	ON	OFF	1 hour
		OFF	OFF	ON	2 hours
		OFF	OFF	OFF	Reserved (0 second)

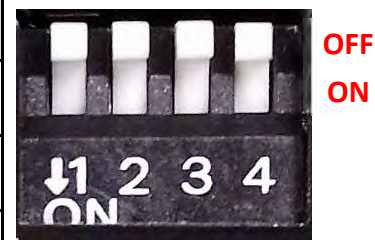

Default setting of Pin1 to Pin4 is OFF/ON/ON/ON.

### 24V\_12V\_1 on CFM-IGN Module: IGN Module Voltage Mode Setting Switch

12V / 24V Car Battery Switch

Pin	Definition
1-2	24V Car Battery Input (Default)
2-3	12V Car Battery Input

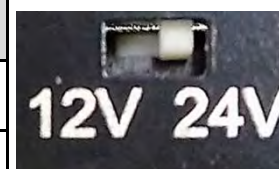

## 6.6 Installing a PB-210-DVI Module

1. Unscrew 2 screws to remove bracket#3 from rear panel.



2. Assemble the CMI-DVI bracket and CMI-DVI module together with 2 D-Sub jack screws.

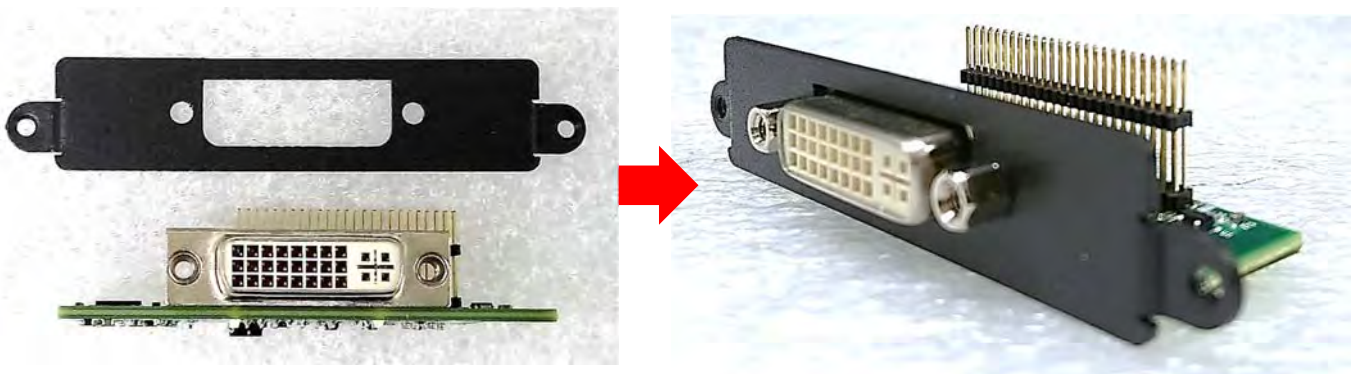

3. Align two holes on the CMI-DVI bracket with the holes on the rear panel.



4. Push the connector pins on CMI-DVI module until the pins can be inserted completely to the female connector (BTB\_FH1) on the system's mainboard.

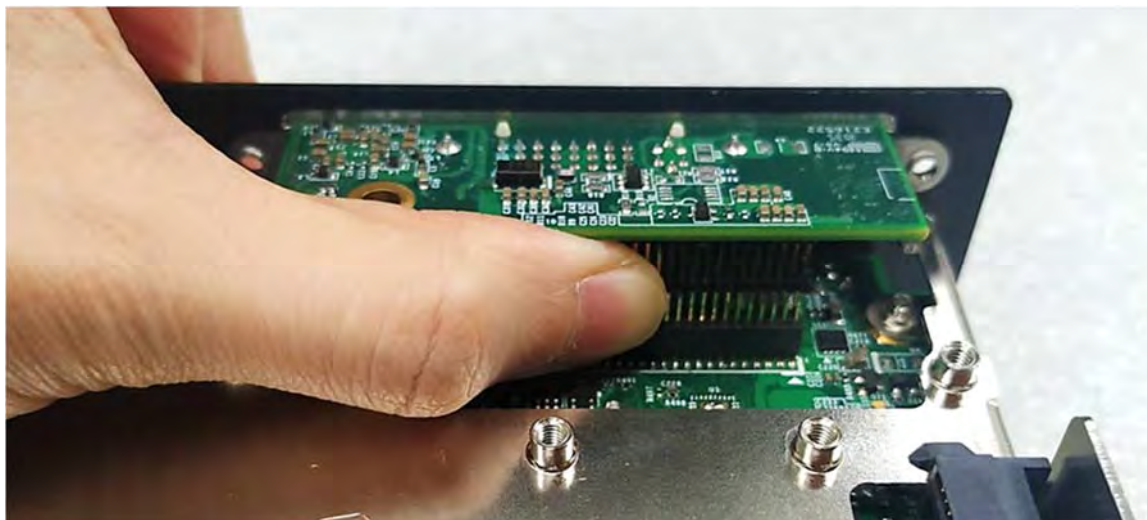

5. Align the hole on CMI-DVI module with the screw hole on the system's mainboard, and fasten a screw to fix it.

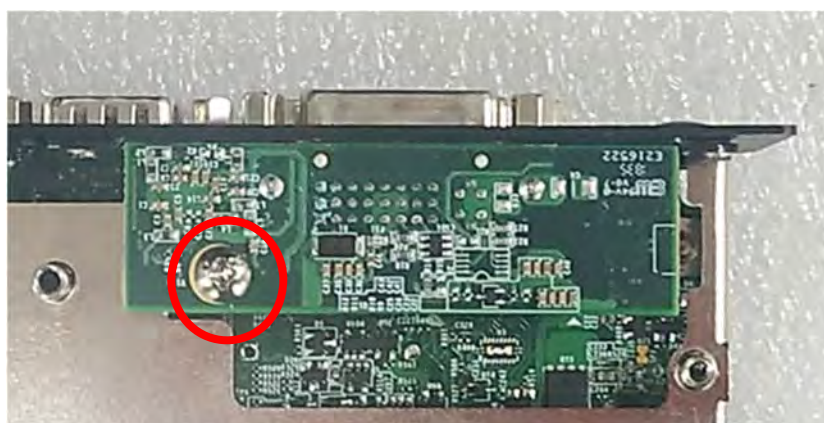

6. Fasten the 2 screws.



## 6.7 Installing a PB-210-VGA Module

1. Unscrew 2 screws to remove bracket#3 from rear panel.



2. Assemble the CMI-VGA bracket and CMI-VGA module together with 2 D-Sub jack screws.

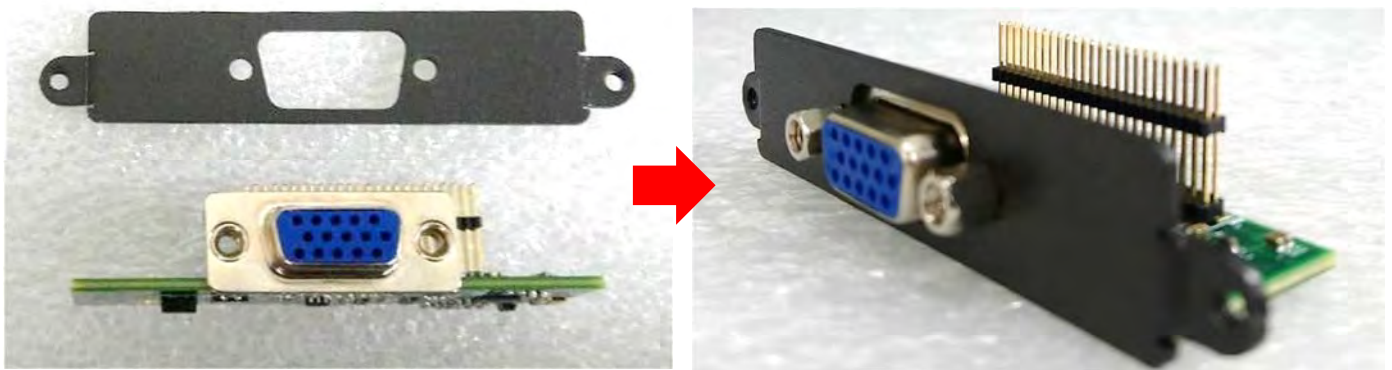

3. Align two holes on the CMI-VGA bracket with the holes on the rear panel.

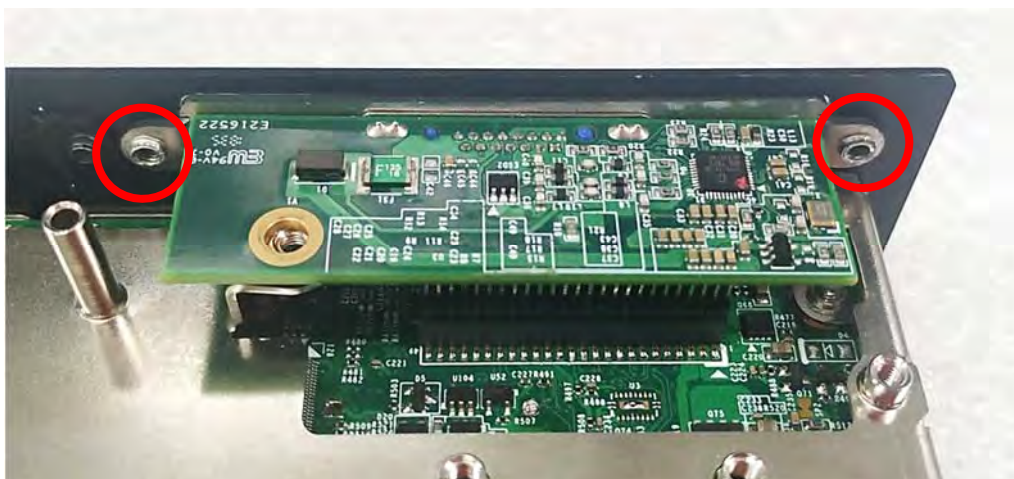

4. Push the connector pins on CMI-VGA module until the pins can be inserted completely to the female connector (BTB\_FH1) on the system's mainboard.



5. Align the screw hole on CMI-VGA module with the screw hole on the system's mainboard, and fasten a screw to fix it.



6. Fasten the 2 screws.





## 6.8 Installing a PB-210-HD Module

1. Unscrew 2 screws to remove bracket#3 from rear panel.



2. Attach the CMI-HD bracket on the backside of system's rear panel, and fasten it with two screws.



3. Align the hole on CMI-HD module with the screw hole on the system's mainboard module, and insert vertically to the female connector (BTB\_FH1) on the system's mainboard.

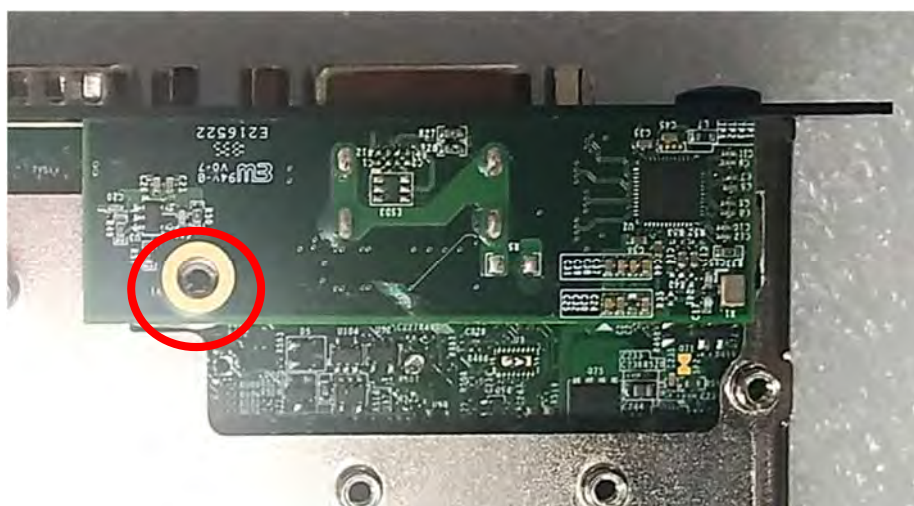

4. Fasten a screw to fix the CMI-HD module.

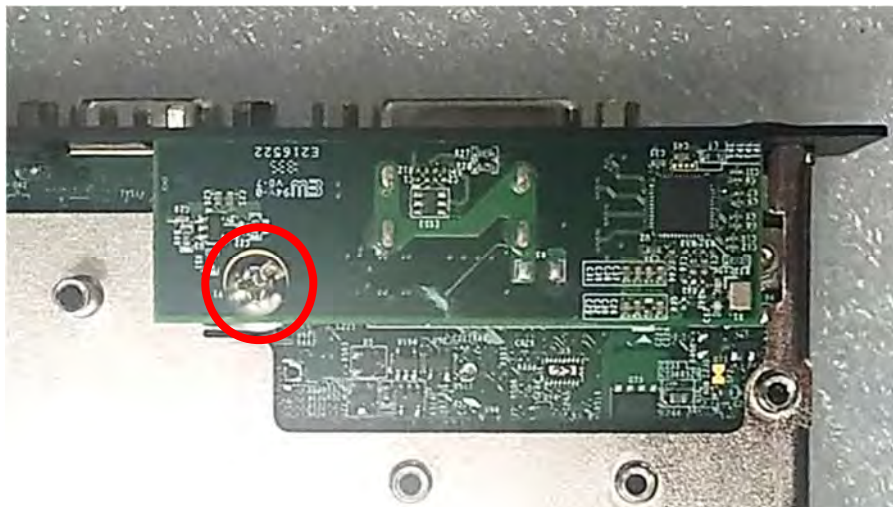

5. The installation is complete.



## 6.9 Installing a PB-210-COM Module

1. Unscrew 2 screws to remove bracket#2 or bracket#3 from rear panel.



2. Assemble the CMI-COM bracket and CMI-COM module together with 4 D-Sub jack screws



3. Align two holes on the CMI-COM bracket with the holes on the rear panel.



4. Push the connector pins on CMI-COM module until the pins can be inserted completely to the female connector (BTB\_FH2 or BTB\_FH1) on the system's mainboard.



5. Make sure the hole on CMI-COM module is aligned with the screw hole on the system's mainboard, and fasten a screw to fix it.

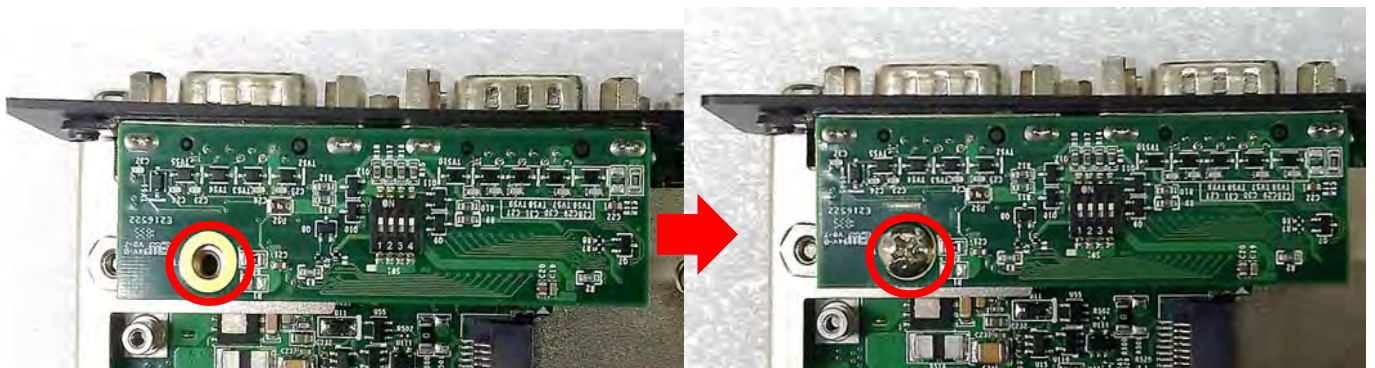

6. Fasten 2 screws for each CMI-COM bracket as marked.



## 6.10 Installing a PB-210-DIO Module

1. Unscrew 2 screws to remove bracket#2 or bracket#3 from rear panel.



2. Attach the CMI-DIO bracket on the backside of system's rear panel, and fasten it with two screws.

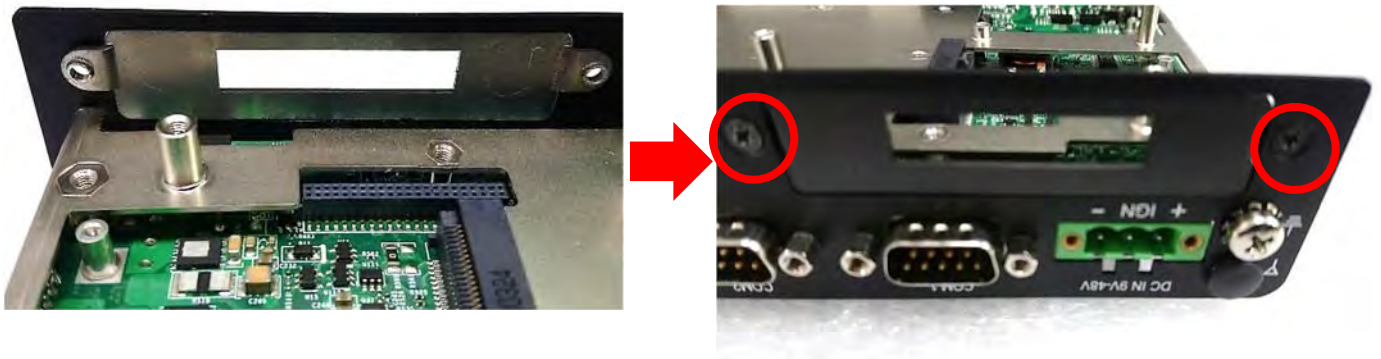

3. Push the connector pins on CMI-DIO module until the pins can be inserted completely to the female connector (BTB\_FH2 or BTB\_FH1) on the system's mainboard.

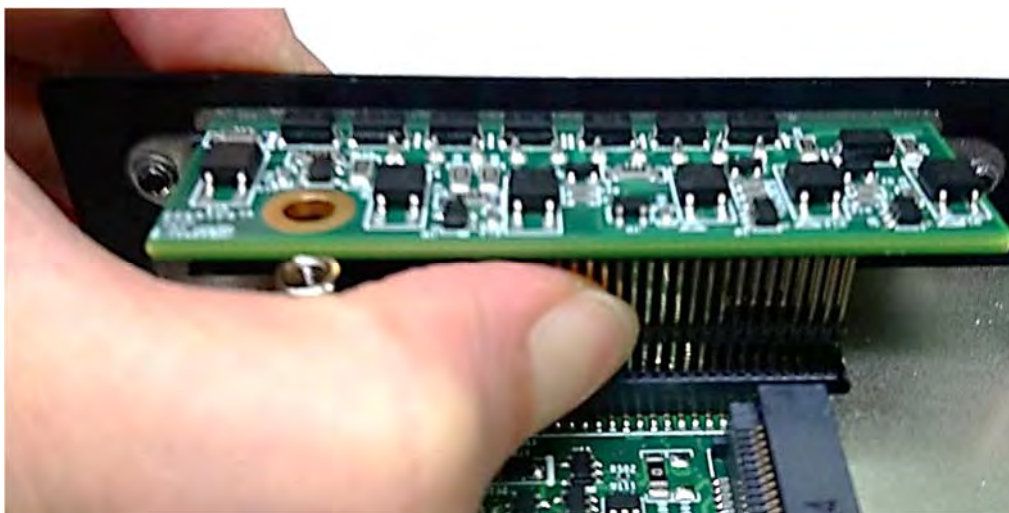

4. Make sure the hole on CMI-DIO module is aligned with the screw hole on the system's mainboard, and fasten a screw to fix it.

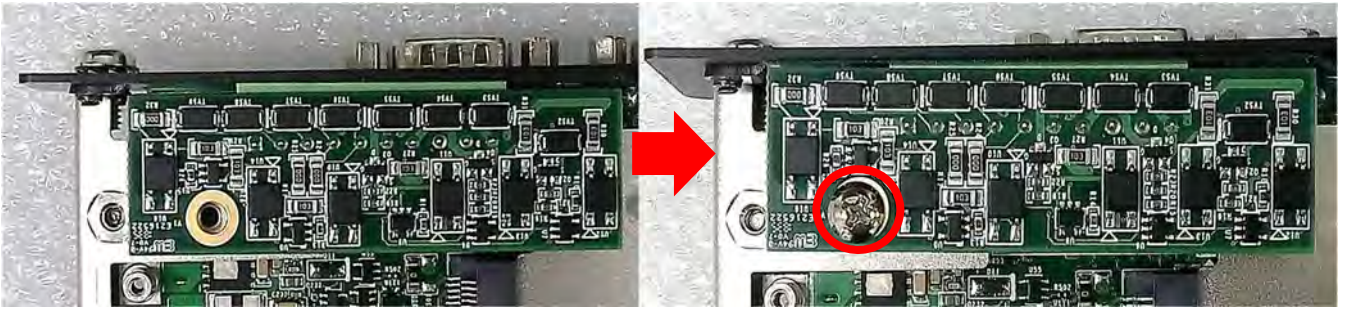

## 6.11 Installing a PB-210-IGN Module

1. Locate the IGN connector on system motherboard as indicated in page 75, and insert the male connector of CFM-IGN module to the female connector on system's mainboard.

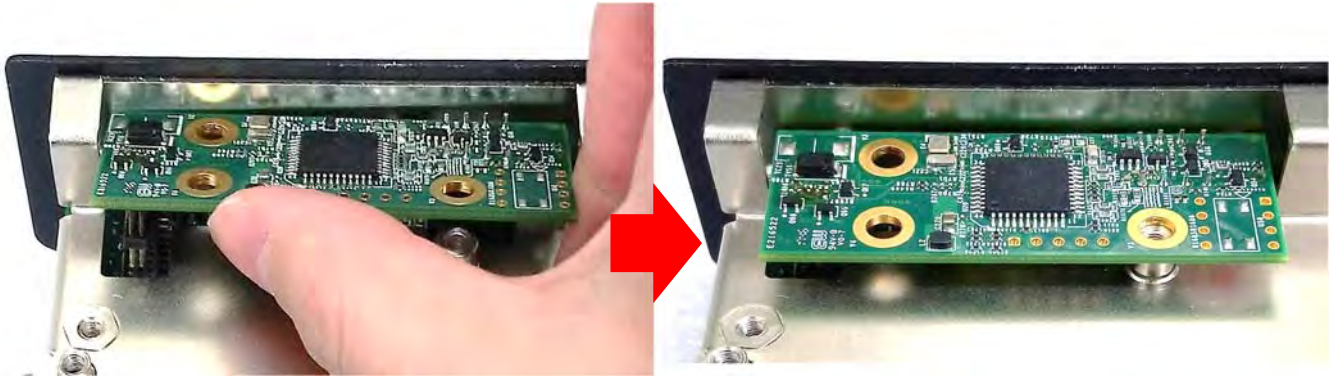

2. Fasten a screw to fix the CFM-IGN Module.

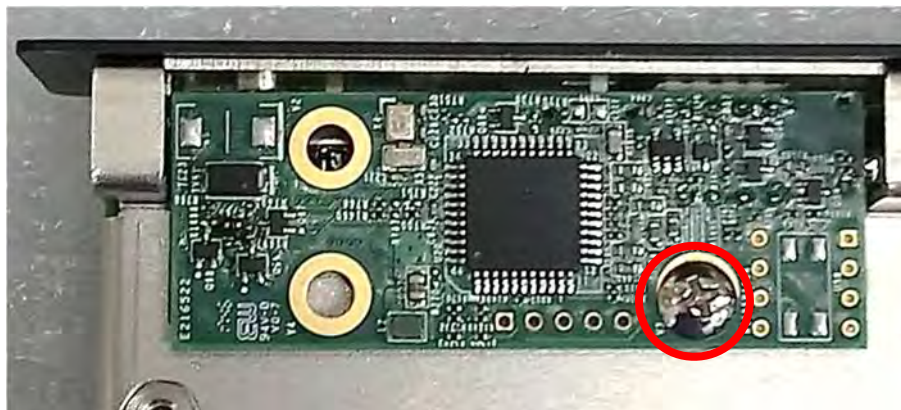

## 6.12 Installing a PB-210-PoE Module

1. Locate the PoE connector on system motherboard as indicated in page 76, and insert the female connector of CFM-PoE module to the male connector on system's mainboard.

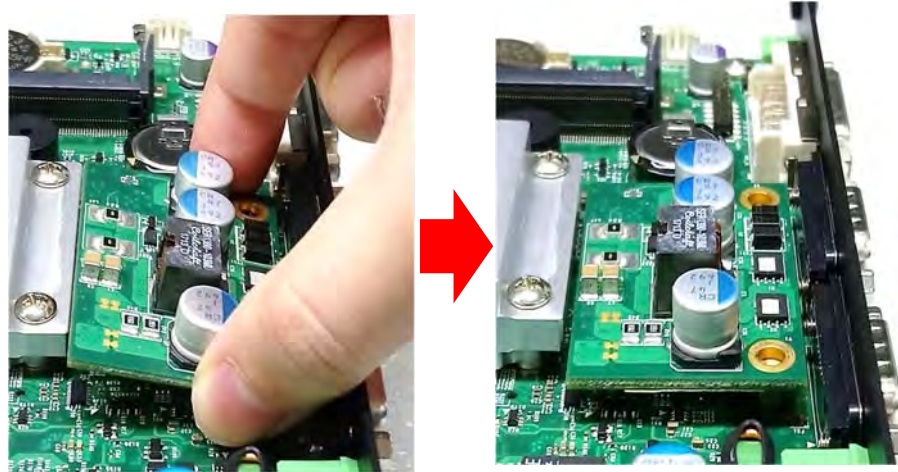

2. Turn over the heatsink and paste the thermal pad onto the marked by red squares.



**Note: Before putting on the heatsink (in the next step), please make sure the protective film on the Thermal Pad has been removed!**

3. Paste the heatsink onto the CFM-PoE module carefully and fasten 2 screws to fix it.

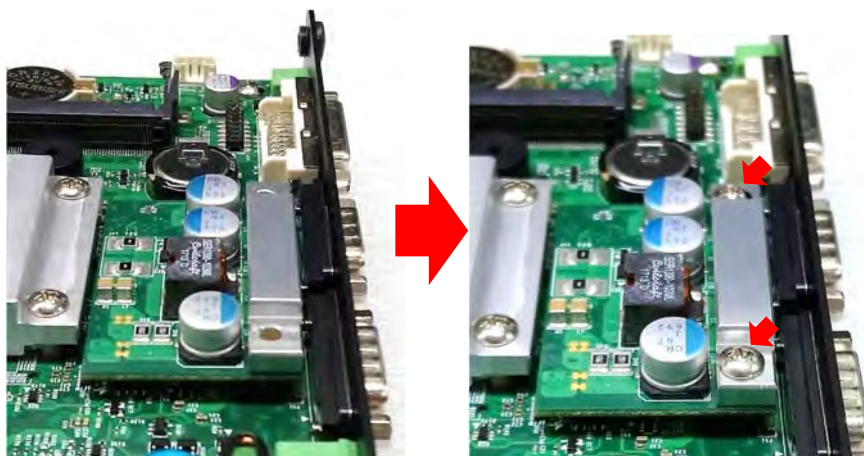

4. Paste the thermal pads onto the heatsink and coil carefully.



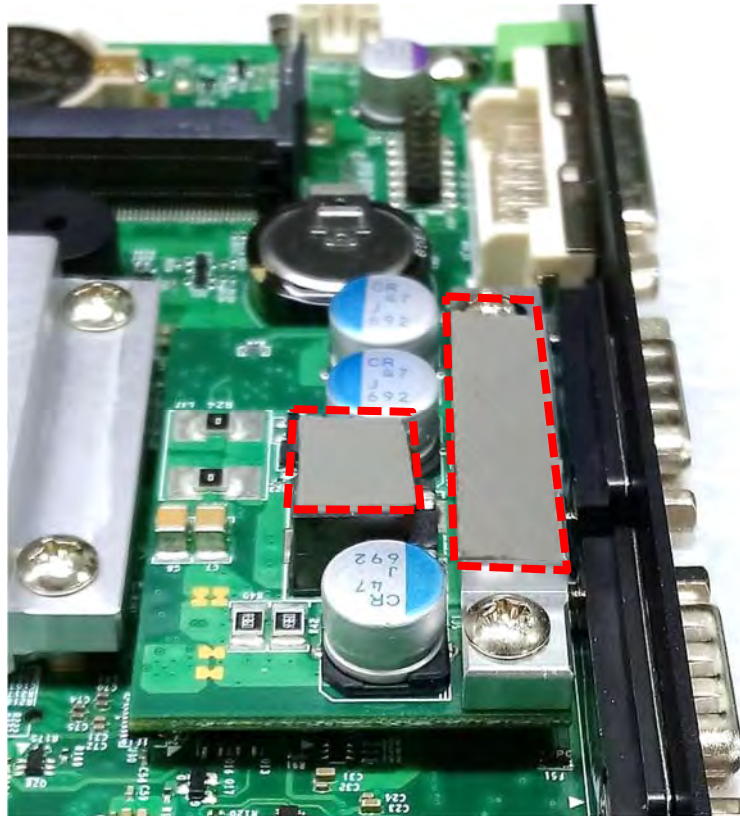

**Note: Before assembling the system's chassis cover, please make sure the protective films on the Thermal Pads have been removed!**

5. When the system is power on, please note that the POE LED will light on if the POE module is properly installed.

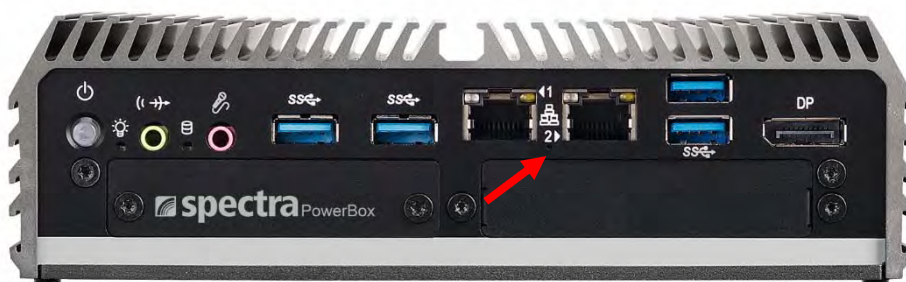

## 6.13 Installing a PB-210-MEC-LAN Module

Model No.	Product Description
PB-210-MEC-LAN-Front	Mini-PCIe Module with 2x LAN Ports, 1x Universal Bracket with 2x RJ45 Cutout for Front Bezel
PB-210-MEC-LAN-Rear	Mini-PCIe Module with 2x LAN Ports, 1x Universal Bracket with 2x RJ45 Cutout for Rear Bezel

### 6.13.1 Rear Panel

1. Locate the Mini PCIe slots.

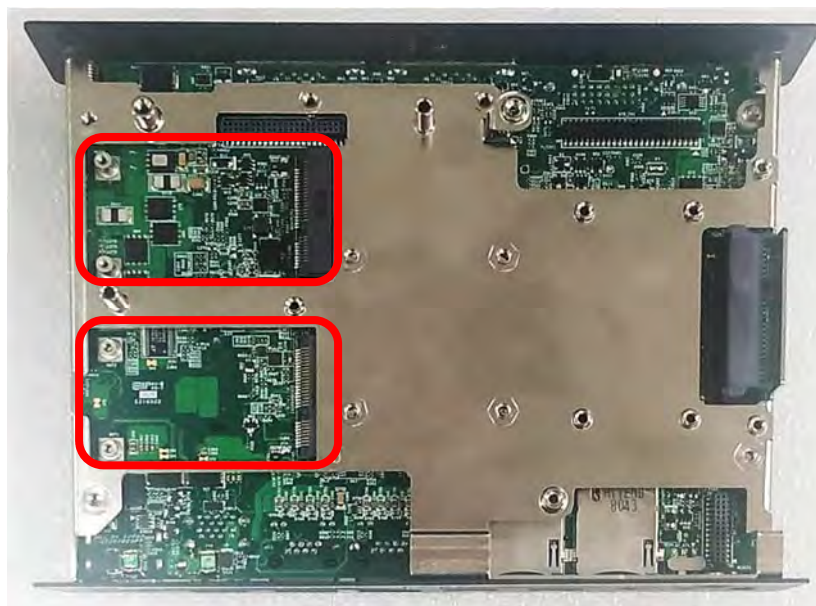

2. Unscrew the 2 screws to remove bracket#3 from the rear panel.



3. Attach the MEC-LAN bracket on the back side of system's rear panel, and fasten it with two screws.



4. Insert the Mini-PCIe card of MEC-LAN module at 45-degree angle and insert it to the either slot until the gold-pated connector of module contacted firmly with the slot.



5. Fasten the two screws.



- Attach the LAN board of MEC-LAN module onto bracket from the back side.



- Fasten the two screws.

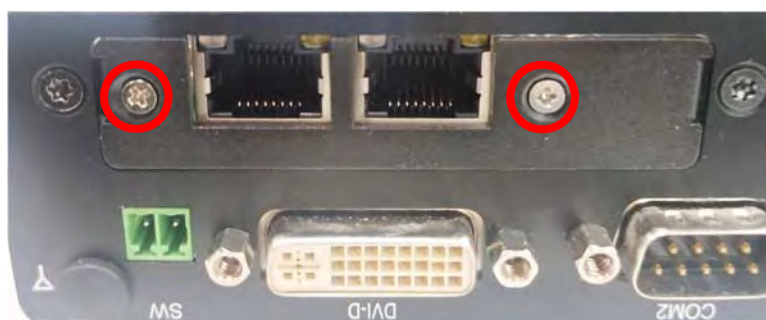

### 6.13.2 Front Panel

- Locate the Mini PCIe slots.

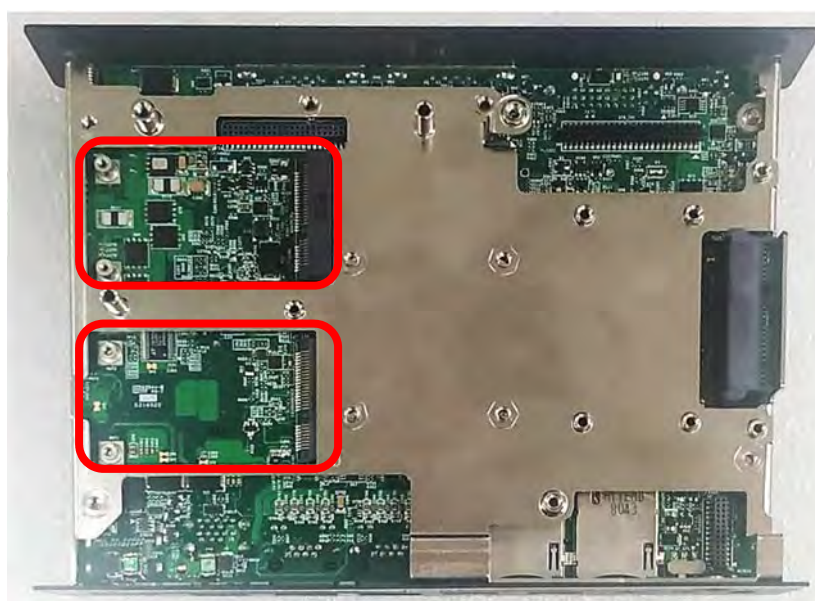

2. Unscrew the 2 screws to remove bracket#1 from the front panel.



3. Attach the MEC-LAN bracket on the back side of system's front panel, and fasten it with two screws.



4. Insert the Mini-PCIe card of MEC-LAN module at 45-degree angle and insert it to the either slot until the gold-pated connector of module contacted firmly with the slot.



5. Fasten the two screws.



6. Attach the LAN board of MEC-LAN module onto bracket from the back side.



7. Fasten the two screws.



## 6.14 Installing a PB-210-MEC-COM Module

Model No.	Product Description
PB-210-MEC-COM	Mini-PCIe Module with 2x COM Ports, 1x Universal Bracket with 2x DB9 Cutout

1. Locate the connectors on MEC-COM module and the accompanied flat ribbon cable.

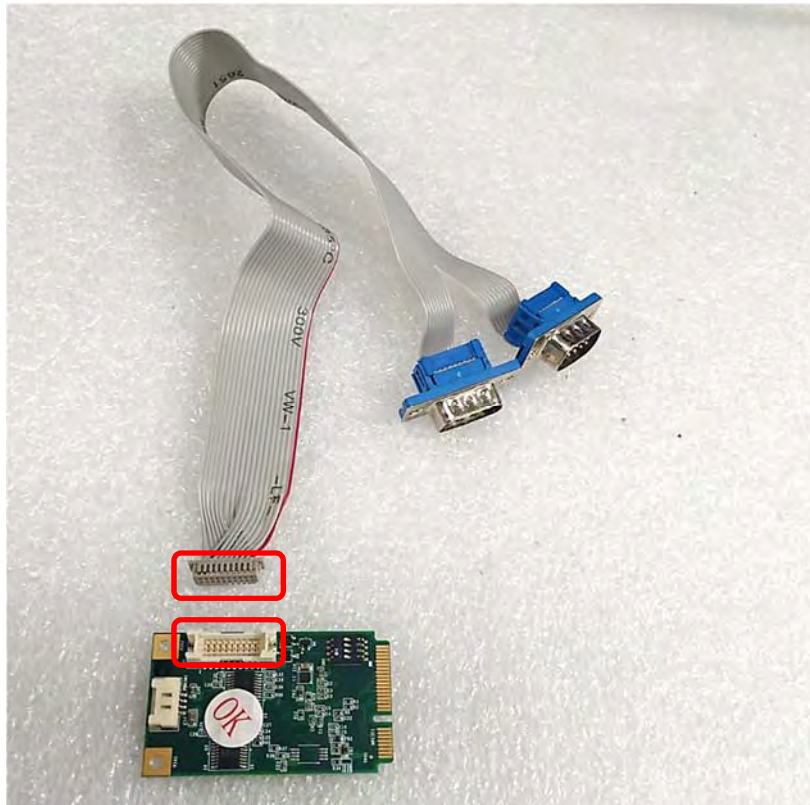

- Align the protrusion and notch on the two connectors. Insert the female connector on the flat ribbon cable to the connector on MEC-COM module.

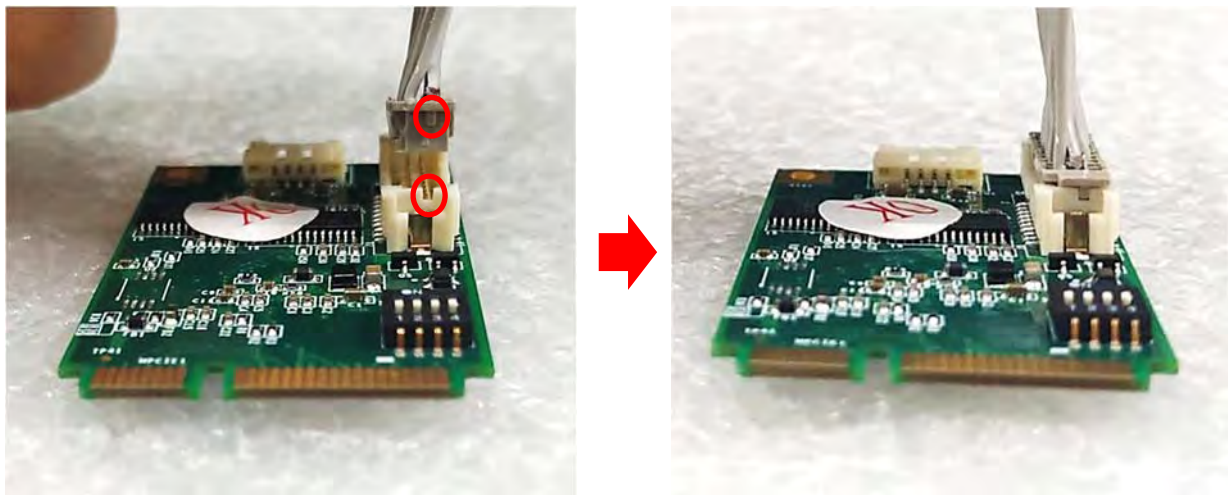

- Locate the Mini PCIe slots.

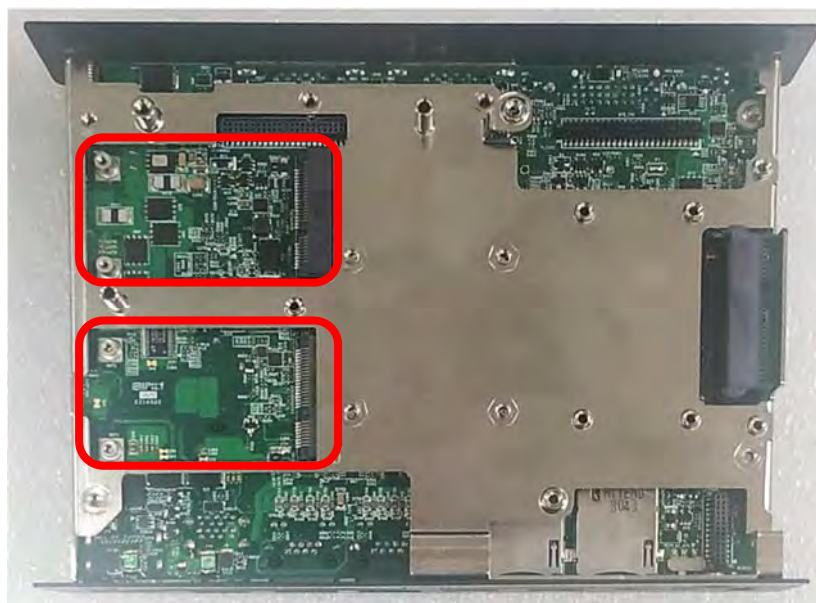



- Unscrew the 2 screws to remove bracket#1 from the front panel.



- Attach the MEC-COM bracket on the back side of system's front panel, and fasten it with two screws.



- Insert the Mini-PCIe card of MEC-COM module at 45-degree angle and insert it to the either slot until the gold-pated connector of module contacted firmly with the slot.



7. Fasten the two screws.

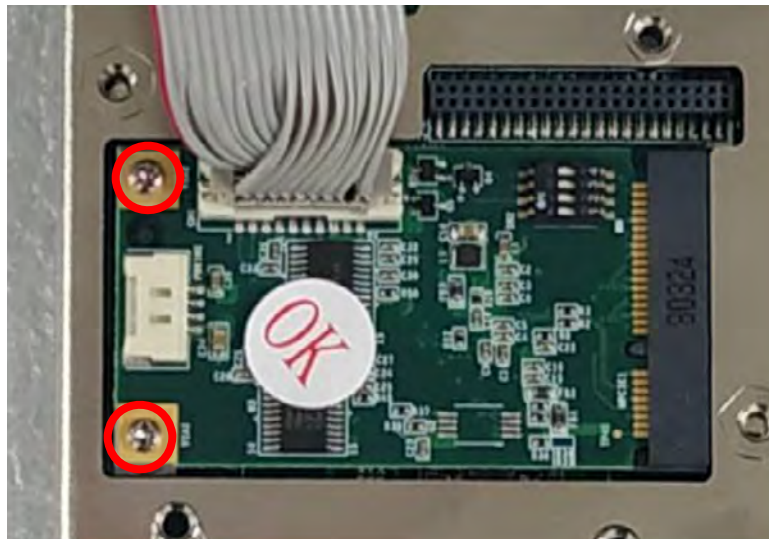

8. Penetrate the COM ports through the bracket from the back side.



9. Fasten the two hex screws.

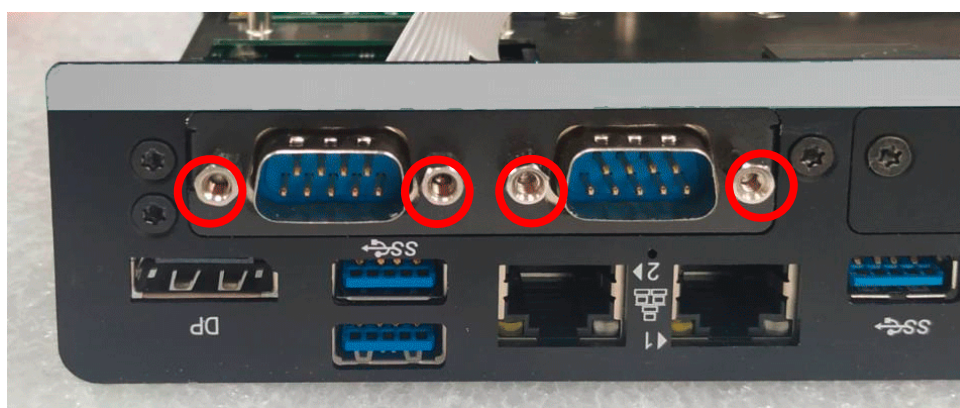

## 6.15 Installing a Side Mount Bracket

Model No.	Product Description
PB-210-SIDE-KIT	Side Mount Kit, with KMRH-K175 for DIN-Rail option

Spectra PowerBox 210 offers Side Mount that customer can install the system onto the right or left side of wall to create effectiveness of space.



1. The mounting holes are at the bottom side of system. There are 8 mounting holes, 4 holes is for installing the Side Mount Bracket from the left side on system's base, the other 4 holes is for installing the Side Mount Bracket from the right side on system's base.

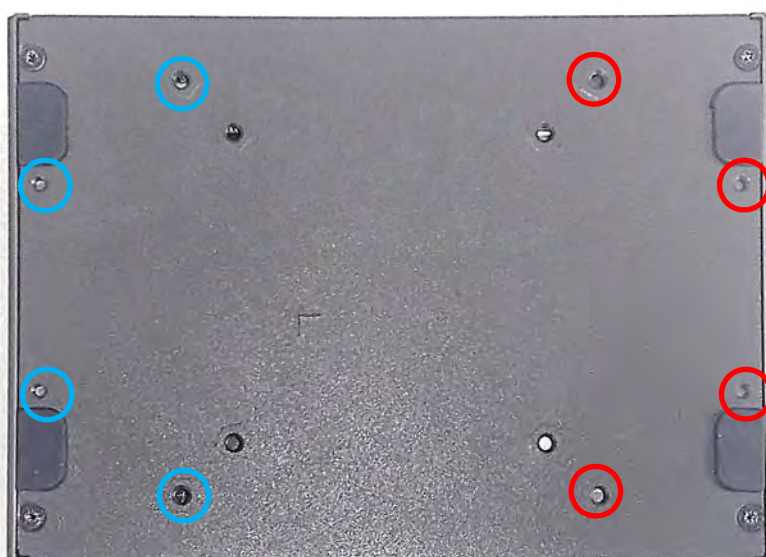

Place the side mount bracket on the bottom of system as shown in the picture below, and fasten the rest of 4 screws to fix the side mount bracket with system together.

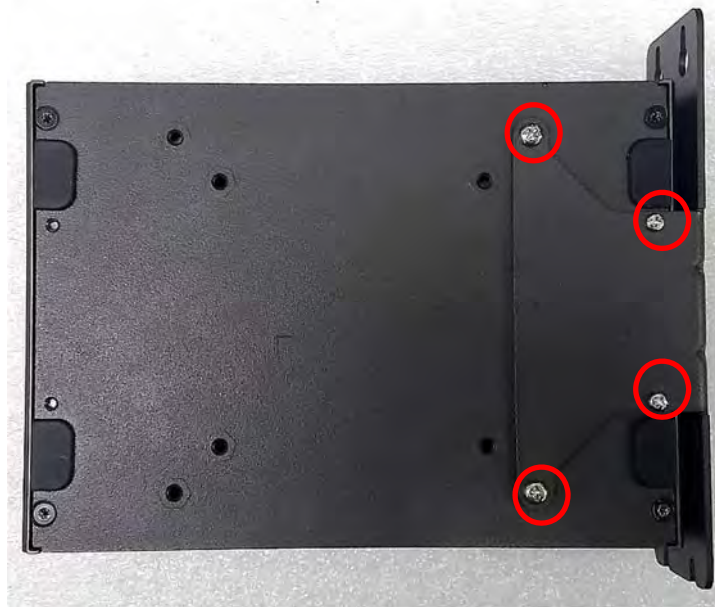

2. It is achievable to mount system on the wall by fastening the screws through the bracket mounting hole.



## 6.16 Installing a VESA Mount Bracket

Spectra PowerBox 210 offers VESA Mount that customer can mount system with VESA standards of 75 mm and 100 mm for various usages.



1. Provided below is the base of the system unit with screw holes specified to be mounted for VESA stand. Blue circles represent the use for VESA 75 mm. Red circles represent the use for VESA 100mm.

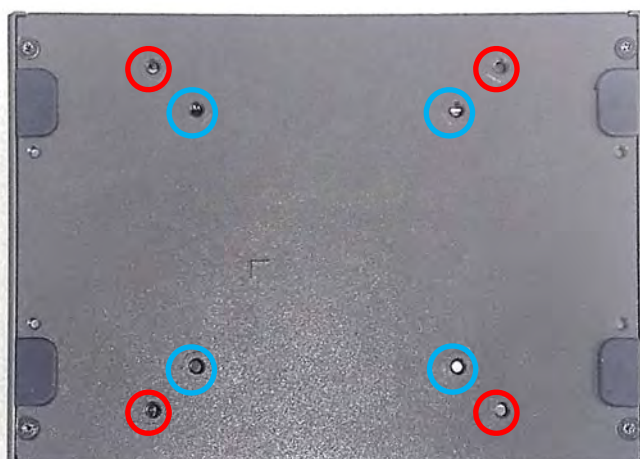

2. Provided below is mounted with VESA stand.

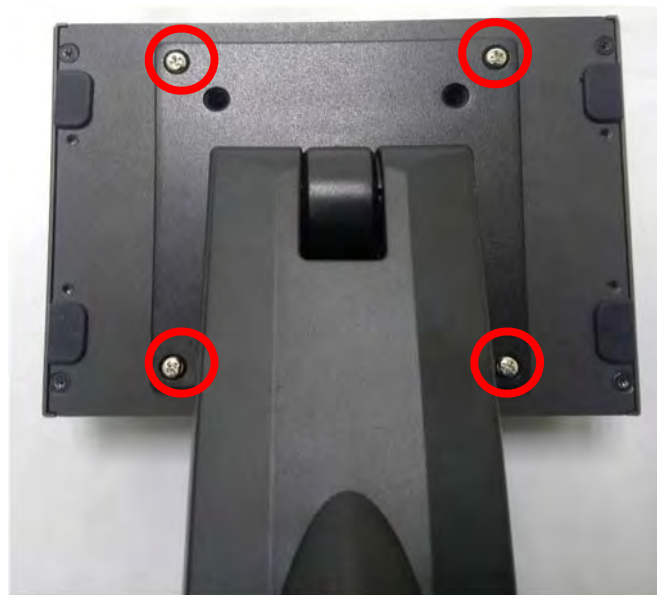

3. Provided below is completion of mounting with VESA stand.



powered by individuality



**Spectra GmbH & Co. KG**

Mahdenstr. 3  
72768 Reutlingen  
Germany

Phone +49 (0) 7121 1432-10  
E-Mail [spectra@spectra.de](mailto:spectra@spectra.de)  
Web [www.spectra.de](http://www.spectra.de)



**Spectra GmbH & Co. KG**

Gewerbepark Ost 1  
4621 Sipbachzell (Wels)  
Austria

Phone +43 (0) 7240 20190  
E-Mail [info@spectra-austria.at](mailto:info@spectra-austria.at)  
Web [www.spectra-austria.at](http://www.spectra-austria.at)



**Spectra (Schweiz) AG**

Flugplatzstr. 5  
8404 Winterthur  
Switzerland

Phone +41 (0) 43 27710-50  
E-Mail [info@spectra.ch](mailto:info@spectra.ch)  
Web [www.spectra.ch](http://www.spectra.ch)

