

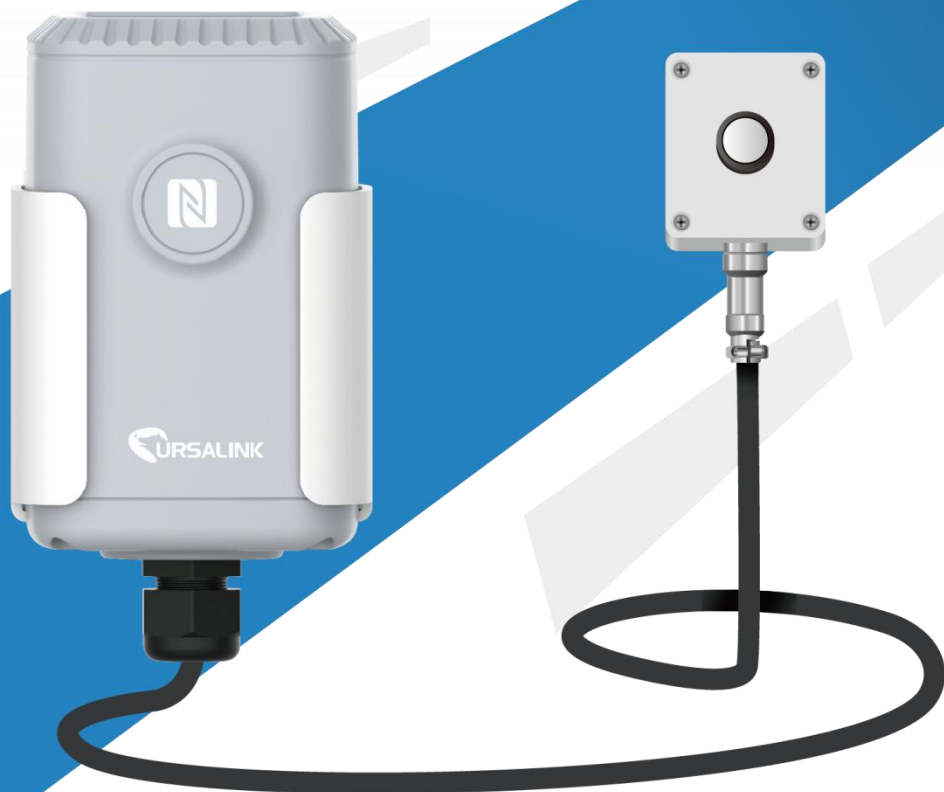

EM500-LGT User Guide



Safety Precautions

Ursalink will not shoulder responsibility for any loss or damage resulting from not following the instructions of this operating guide.

- ❖ The device must not be remodeled in any way.
- ❖ Please clarify your application environment before deployment, in case the device can function well.
- ❖ The device is not intended to be used as a reference sensor, and Ursalink will not should responsibility for any damage which may result from inaccurate readings.
- ❖ Do not place the device cable close to objects with naked flames.
- ❖ Do not place the device, cable and sensor where the temperature is below/above the operating range.
- ❖ Make sure electronic components do not drop out of the enclosure while opening.
- ❖ When closing the lid, make sure the lid is fitted the right way, so that the enclosure is properly sealed.
- ❖ When installing the battery, please install it accurately, and do not install the reverse or wrong model.
- ❖ The device must never be subjected to shocks or impacts.

Declaration of Conformity

Ursalink EM500-LGT is in conformity with the essential requirements and other relevant provisions of the CE, FCC, and RoHS.



© 2017-2020 Xiamen Ursalink Technology Co., Ltd.

All rights reserved.

All information in this guide is protected by copyright law. Whereby, no organization or individual shall copy or reproduce the whole or part of this user guide by any means without written authorization from Xiamen Ursalink Technology Co., Ltd.



For assistance, please contact
Ursalink technical support:
Email: helpdesk@ursalink.com
Tel: 86-592-5023060
Fax: 86-592-5023065

Revision History

Date	Doc Version	Description
August 11, 2020	V 1.0	Initial version

Contents

1. Overview.....	4
1.1 Description.....	4
1.2 Features.....	4
1.3 Specifications.....	4
2. Hardware Introduction.....	5
2.1 Packing List.....	5
2.2 Transceiver Overview.....	5
2.3 Dimensions.....	6
3. Assembly and Preparation.....	6
3.1 Sensor Assembly.....	6
3.2 Insulating Sheet Disassembly.....	7
4. Turn ON/OFF and Reset (Power Button).....	8
5. Sensor Configuration.....	8
5.1 Configuration via Smartphone APP.....	8
5.1.1 Read/Write Configuration via NFC.....	8
5.1.2 Template Configuration.....	10
5.2 Configuration via PC.....	11
5.2.1 Log in the Toolbox.....	11
5.2.2 Basic Configuration.....	12
5.2.3 Template and Reset.....	14
5.2.4 Upgrade.....	14
5.3 Configuration Examples.....	15
5.3.1 LoRaWAN Channel Settings.....	15
5.3.2 Data Calibration Settings.....	16
5.3.3 Alarm Settings.....	16
6. Installation.....	17
6.1 Transceiver Installation.....	17
6.1.1 Wall Mounting.....	17
6.1.2 Pole Mounting.....	17
6.1.3 DIN Rail Mounting.....	18
6.2 Sensor Installation.....	18
7. Payload Format.....	19
8. Sensor Management via Uursalink Cloud.....	19
8.1 Uursalink Cloud Registration.....	19
8.2 Add a Uursalink LoRaWAN Gateway.....	20
8.3 Add EM500-LGT to Cloud.....	21
Appendix.....	22
Default LoRaWAN Parameters.....	22
Default Uplink Channels.....	22

1. Overview

1.1 Description

EM500-LGT is an outdoor environment monitoring sensor mainly used to measure environment light through wireless LoRa network. EM500-LGT device is battery powered and designed for multiple mounting ways. It is equipped with NFC (Near Field Communication) and can easily be configured by a smartphone or a PC software.

Sensor data are transmitted in real-time using standard LoRaWAN protocol. LoRaWAN enables encrypted radio transmissions over long distance while consuming very little power. The user can obtain sensor data and view the trend of data change through Ursalink Cloud or through the user's own Network Server.

1.2 Features

- Wide measuring range and high precision
- Up to 11km communication range
- Easy configuration via NFC
- Standard LoRaWAN support
- Ursalink Cloud compliant
- Low power consumption with 19000mAh replaceable battery

1.3 Specifications

LoRaWAN	
Frequency	EU433/CN470/IN865/RU864/EU868/US915/AU915/KR920/AS923
Tx Power	20dBm
Sensitivity	-147dBm @300bps
Mode	OTAA/ABP Class A
Antenna	Embedded Ceramic Antenna
Temperature Measurement	
Range	0-100000 lux
Accuracy	± 0.3%
Resolution	1 lux
Physical Characteristics	
Cable Length	3m
Power Supply	19000 mAh Li-SoCl ₂ battery
Operating Temperature	-30°C to +60°C

Relative Humidity	0% to 100% (non-condensing)
Dimension	Transceiver: 105 × 71 × 69.5 mm (Waterproof connector is not included) Light sensor: 64 × 58 × 34 mm
Mounting	Pole, wall, DIN rail

2. Hardware Introduction

2.1 Packing List



1 × EM500-LGT
(Include sensor)



2 × Mounting
Screws



1 × Hose
Clamp



1 × Warranty Card



1 × Quick Guide

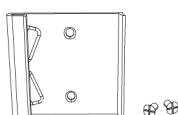

1 × DIN Rail (Optional)



If any of the above items is missing or damaged, please contact your Ursalink sales representative.

2.2 Transceiver Overview



Front View:

- ① LoRa Antenna (Internal)
- ② NFC Area
- ③ Water-proof Connector

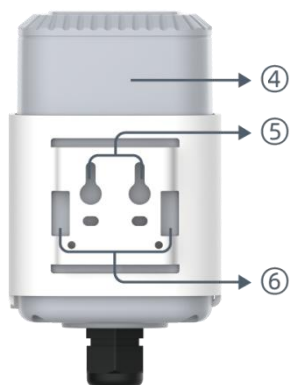
**Back View:**

- ④ Battery (Internal)
- ⑤ Wall Mounting Holes
- ⑥ Pole Mounting Holes

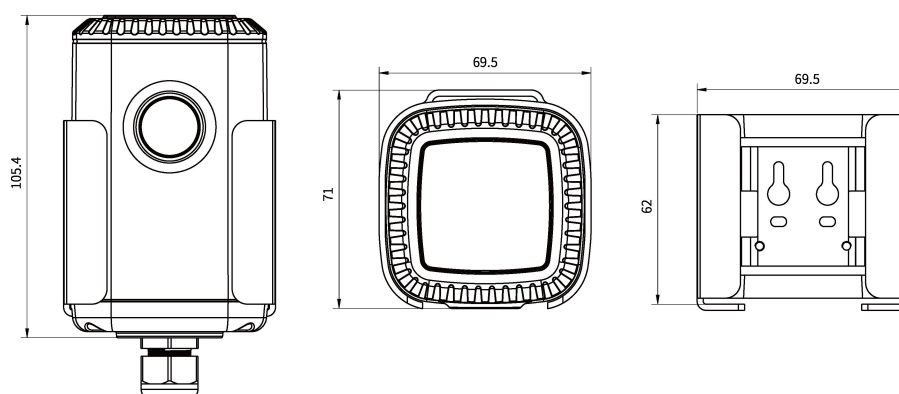
2.3 Dimensions(mm)**3. Assembly and Preparation****3.1 Sensor Assembly**

Follow the steps below to connect light sensor cable to EM500 transceiver if they are separated.

1. Take off the mounting bracket, remove the cap, rubber seal and the screws on the bottom of the device, and then take off the enclosure cover.
2. Pass the cable through the cap, rubber seal and enclosure cover.

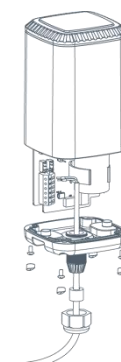
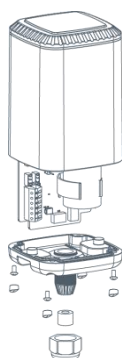

3. Pull out the motherboard, insert and lock the wires accordingly (see the label on the motherboard or following picture).

4. Put the motherboard back and restore everything in its due position.

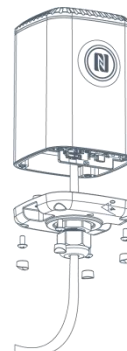
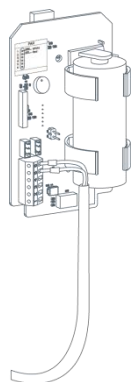

Pinouts:

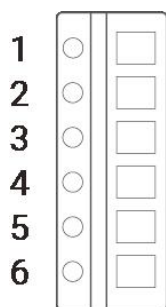

PIN	Color	Description
1	Black	GND
2	--	--
3	---	--
4	Blue	B
5	Green	A
6	Red	VOUT

3.2 Insulating Sheet Disassembly

Pull out the insulating sheet on the side of the battery and check if electrode of the battery is reversed.

Note: Refer to [Chapter 4](#) to check if EM500 can be turned on via power button.

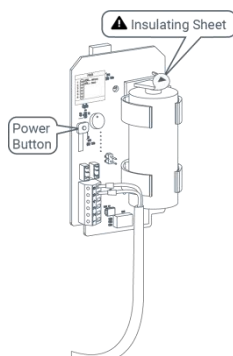

4. Turn ON/OFF and Reset (Power Button)

 The LED indicator is inside the device. EM500-LGT can also be turned on/off and reset via Mobile APP or Toolbox.

Function	Action	LED Indication
Turn On	Press and hold the button for more than 3 seconds.	Off → Static Green
Turn Off	Press and hold the button for more than 3 seconds.	Static Green → Off
Reset	Press and hold the button for more than 10 seconds. Note: EM500 will automatically power on after reset.	Blink 3 times.
Check On/Off Status	Quickly press the power button.	Light On: Device is on. Light Off: Device is off.

5. Sensor Configuration

Ursalink EM500-LGT sensor can be monitored and configured via one of the following methods:

- Mobile APP (NFC);
- Windows software (NFC or Type-C port).

In order to protect the security of sensor, password validation is required when turning on/off the sensor or changing configuration. Default password is **123456**.

5.1 Configuration via Smartphone APP

Preparation:

- Smartphone (NFC supported)
- Toolbox APP: download and install from Google Play or Apple Store.

5.1.1 Read/Write Configuration via NFC

1. Enable NFC on the smartphone and open "Toolbox" APP.
2. Attach the smartphone with NFC area to the device to read basic information.

Note: Ensure your smartphone NFC area and it is recommended to take off phone case before using NFC.

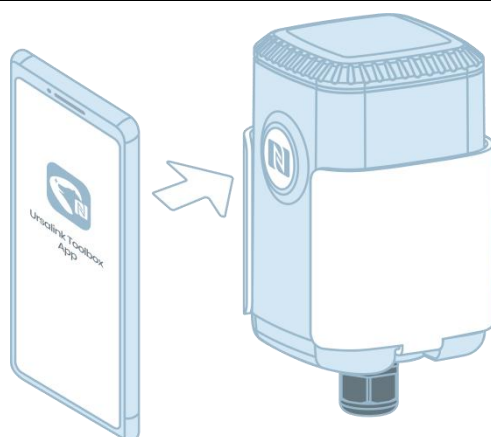

3. When you perform one of the following operations, enter the password and attach the smartphone with NFC area to the device until the APP shows a successful prompt.

- Turn on/off the sensor
- Reset the sensor
- Tap “Write” to change settings in “Device > Settings”.

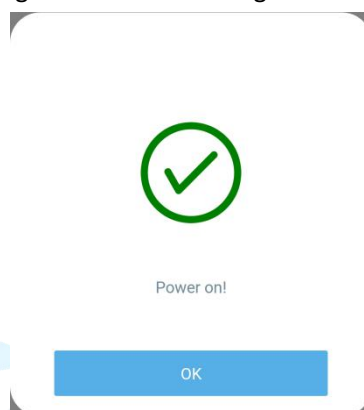

1. Go to “Device > Status” to tap “Read” and attach the smartphone with NFC area to the device to read real-time data of sensor.

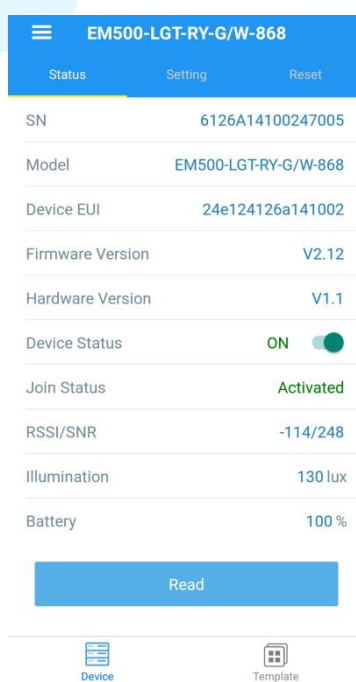

5.1.2 Template Configuration

Template settings are used for easy and quick device configuration in bulk.

Note: Template function is allowed only for sensors with the same model and LoRa frequency band.

1. Go to “Template” page on the APP and save current settings as a template.

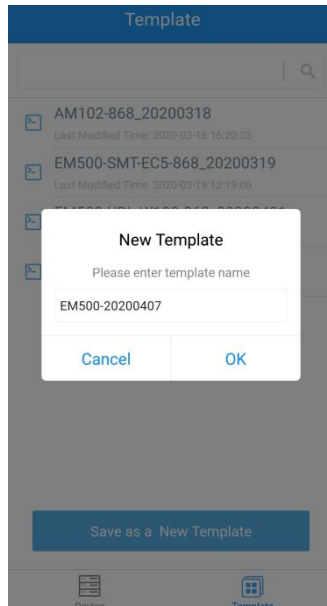

2. Attach the smartphone with NFC area to another device.
3. Select the template file from Toolbox APP and tap “Write”.

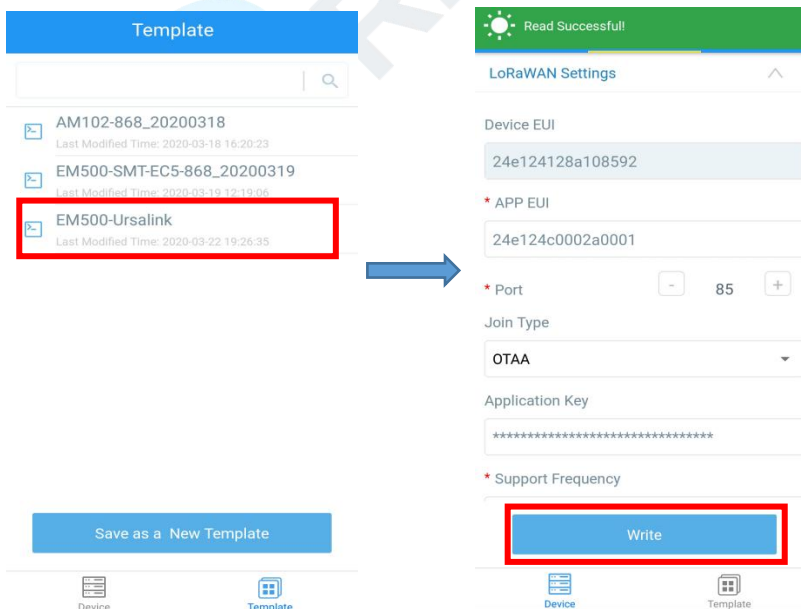

4. Enter password of this device and keep the two devices close until the APP shows a successful prompt.



Write successfully!

OK

- Slide the template item to the left to edit or delete the template.

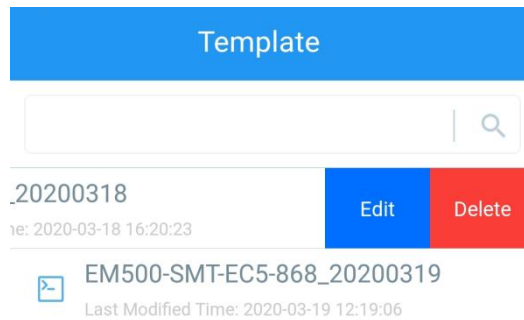

5.2 Configuration via PC

Preparation:

- Dedicated NFC Reader or Type-C USB cable
- PC (Windows 10)
- Toolbox: <https://www.ursalink.com/en/software-download/>

5.2.1 Log in the Toolbox

Make sure "Toolbox" is downloaded on your computer. Select one of the following methods to log in Toolbox.

Type-C Connection

- Connect the EM500-LGT to computer via type-C port.



Type-C port is inside the transceiver of the EM500-LGT.

- Select type as "General" and click password to log in Toolbox. (Default password: 123456)

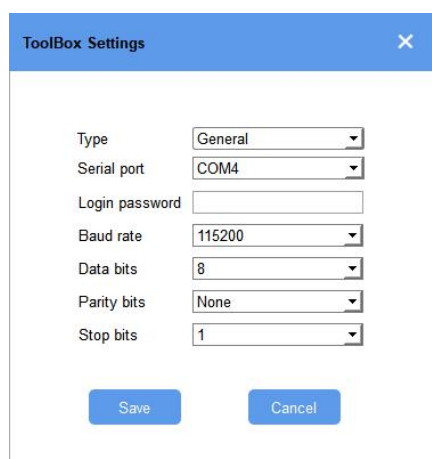

ToolBox Settings

Type: General

Serial port: COM4

Login password:

Baud rate: 115200

Data bits: 8

Parity bits: None

Stop bits: 1

Save Cancel

NFC Connection

1. Connect the NFC reader to computer, then attach the EM500-LGT to NFC area of the reader.
2. Select type as “NFC” and serial port as NFC reader port on Toolbox.

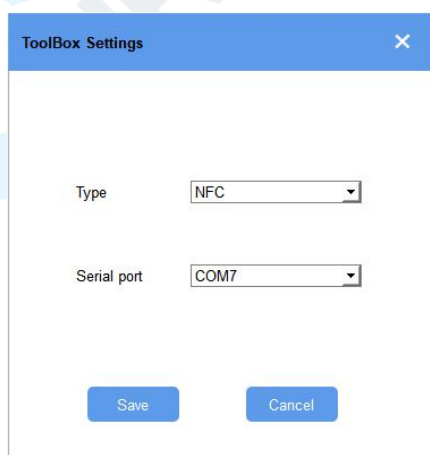
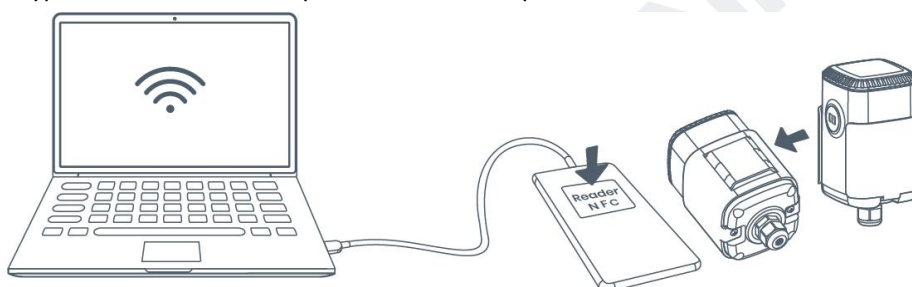

ToolBox Settings

Type: NFC

Serial port: COM7

Save Cancel

5.2.2 Basic Configuration

1. Click “Read” to read current data of the sensor.

Status

LoRaWAN Settings

Device Settings

Maintenance

Status > Read Power Off

Model:	EM500-LGT-RY-GW-868
Serial Number:	6126A14100247005
Device EUI:	24E124126A141002
Firmware Version:	02.12
Hardware Version:	1.1
Device Status:	On
Join Status:	Activate
RSSI/SNR:	-114/-8
Illumination:	130 lux
Battery:	100%
Channel Mask:	0007
Uplink Frame-counter:	25
Downlink Frame-counter:	18

2. When you perform one of the following operations, enter the password and wait a few seconds until toolbox shows a successful prompt. (Password is not needed if you connect it via type-C port)

- Turn on/off the sensor
- Reset the sensor
- Click “Write” to change settings

LoRaWAN >

Read Write

Basic
Channel

Device EUI

Verify Password ✕

Password:

Enter

Please put the NFC antenna close to the NFC reader.

Regular Report Confirmed ?

ADR Mode

Save

Downlink Frame-counter: 1

Success

Firmware Version: 01.01

5.2.3 Template and Reset

5.2.3.1 Template Configuration

Note: Template function is allowed only for sensors with the same model and LoRa frequency band.

1. Go to “Maintenance -> Template and Reset” page in Toolbox.
2. Click “Export” to save the current settings as a template.



3. Click “Browse” to select the correct template from computer.
4. Click “Import” to import the template to the device.

5.2.4.2 Reset

Go to “Maintenance -> Template and Reset” page in Toolbox, then click the “Reset” to reset the device to the factory settings.



5.2.4 Upgrade

1. Download firmware on your computer.
2. Go to “Maintenance -> Upgrade” page in Toolbox.
3. Click “Browse” and select the firmware from computer.
4. Click “Upgrade” to upgrade the device.

Note: If NFC connection is selected, please keep the two devices close and don't move them in order to get the best connectivity as possible when upgrading.

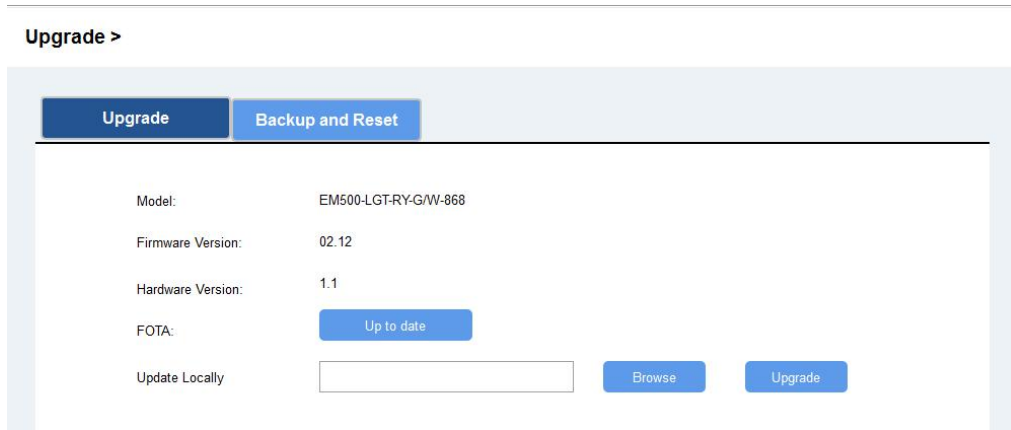

5.3 Configuration Examples

5.3.1 LoRaWAN Channel Settings

The configuration of LoRaWAN channel of EM500-LGT must match the LoRaWAN gateway's. Refer to [Appendix](#) to check default channel settings of EM500-LGT.

Mobile APP Configuration:

Open Toolbox APP and go to "Device ->Setting -> LoRaWAN Settings" to change the frequency and channels.

Software Configuration:

Log in Toolbox and go to "LoRaWAN Settings -> Channel" to change frequency and channels.

Note: If frequency is one of CN470/AU915/US915, you can enter the index of the channel that you want to enable in the input box, making them separated by commas.

Examples:

1, 40: Enabling Channel 1 and Channel 40

1-40: Enabling Channel 1 to Channel 40

1-40, 60: Enabling Channel 1 to Channel 40 and Channel 60

All: Enabling all channels

Null: Indicates that all channels are disabled

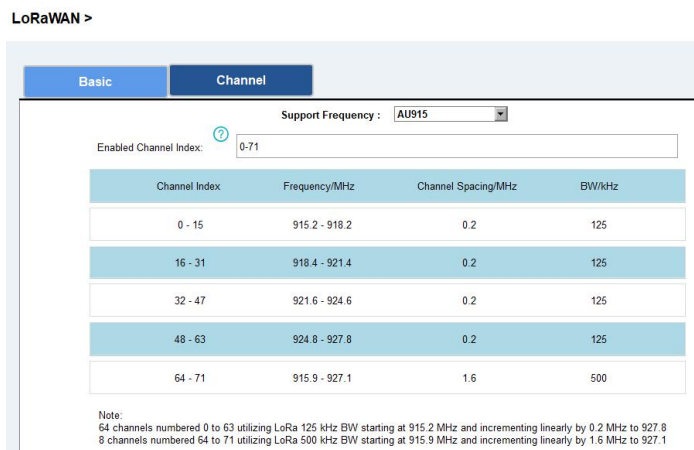
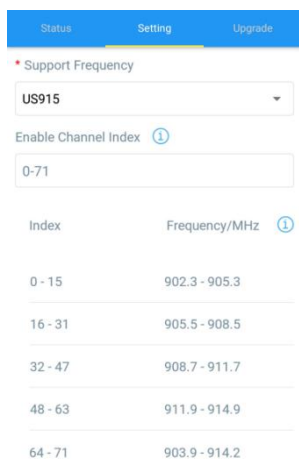

5.3.2 Data Calibration Settings

Mobile APP Configuration:

Open Toolbox APP and go to “Device -> Setting -> Calibration Settings” to enable the calibration and input the calibration value.

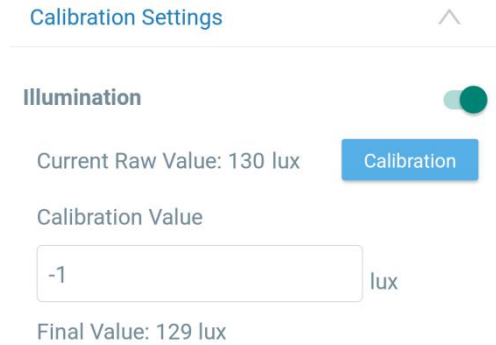

Calibration Settings

Illumination

Current Raw Value: 130 lux Calibration

Calibration Value

lux

Final Value: 129 lux

Software Configuration:

Log in Toolbox and go to “Device Settings -> Basic -> Calibration Settings” to enable the calibration and type the calibration value.

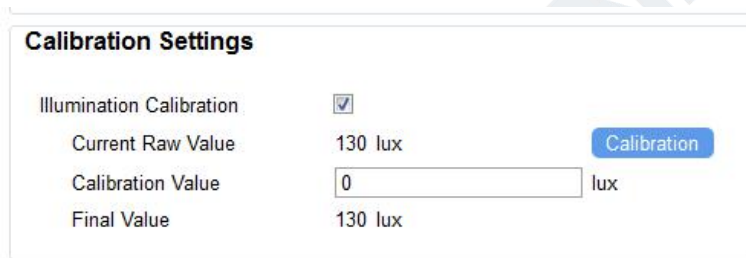

Calibration Settings

Illumination Calibration

Current Raw Value 130 lux Calibration

Calibration Value lux

Final Value 130 lux

5.3.3 Alarm Settings

EM500-LGT will upload the current data instantly after the threshold is triggered.

Mobile APP Configuration:

Open Toolbox APP and go to “Device -> Setting -> Threshold Settings” to enable the threshold settings and input the threshold.

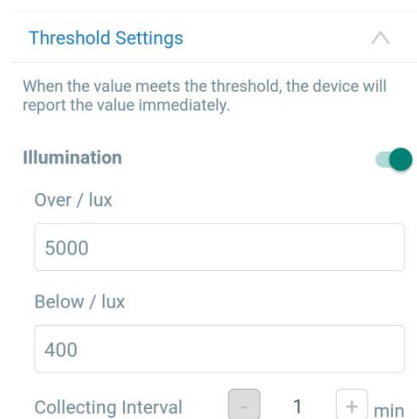

Threshold Settings

When the value meets the threshold, the device will report the value immediately.

Illumination

Over / lux

Below / lux

Collecting Interval 1 min

Software Configuration:

Log in Toolbox and go to “Device Settings -> Basic -> Threshold Settings” to enable the calibration and input the calibration value.

Threshold Settings 

Illumination	<input checked="" type="checkbox"/>	
Over	<input type="text" value="0"/>	lux
Below	<input type="text" value="0"/>	lux
Data Collecting Interval	<input type="text" value="1"/>	min

6. Installation

6.1 Transceiver Installation

6.1.1 Wall Mounting

1. Attach the mounting bracket to the wall and mark the two holes(around 16mm) on the wall.

Note: The connecting line of two holes must be a horizontal line.

2. Drill the holes according to the marks and screw the mounting screws into the wall.

3. Mount the device on the wall.

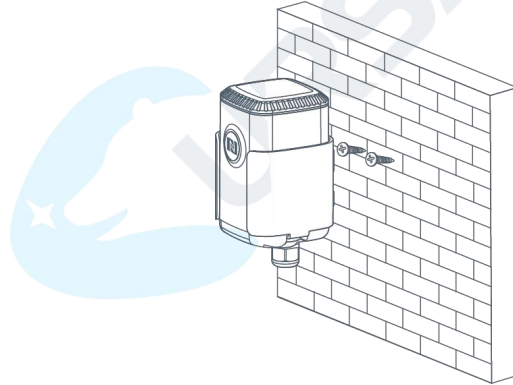

6.1.2 Pole Mounting

1. Loosen the hose clamp by turning the locking mechanism counter-clockwise.



2. Straighten out the hose clamp and slide it through the rectangular holes in the mounting bracket, wrap the hose clamp around the pole.

3. Use a screwdriver to tighten the locking mechanism by turning it clockwise.

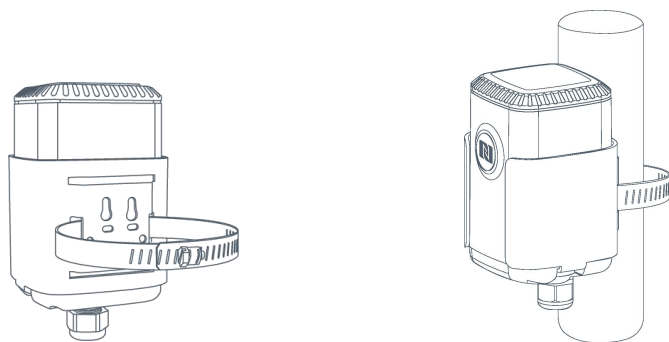

6.1.3 DIN Rail Mounting

Use 2 pieces of M3 × 6 flat head Phillips screws to fix the DIN rail to the device, and then hang the DIN rail on the mounting bracket. It is necessary to choose a standard bracket.

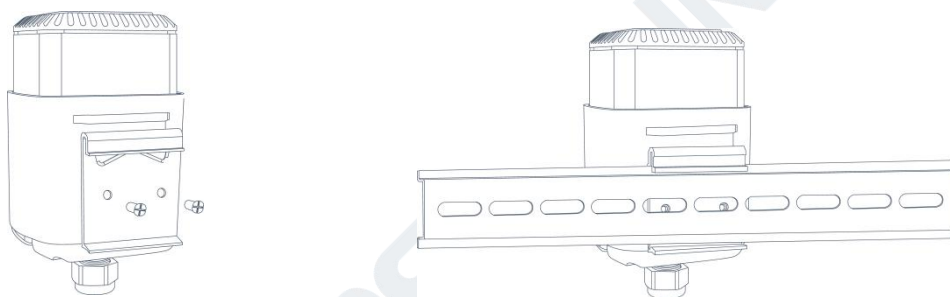

6.2 Sensor Installation

Light sensor supports mount on the wall or plane surface. Be sure place the round area of the sensor always on top and always towards the sun while using it.

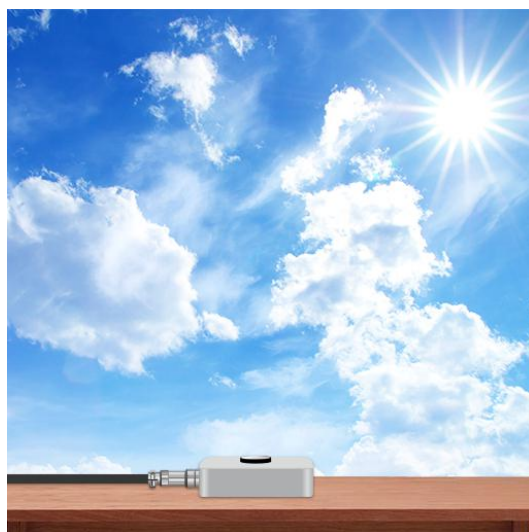

7. Payload Format

All data are based on following format:

Channel1	Type1	Data1	Channel2	Type2	Data2	Channel 3	...
1 Byte	1 Byte	N Bytes	1 Byte	1 Byte	M Bytes	1 Byte	...

Please refer to decoder example: <https://github.com/Ursalink-CN/ursalink-decoder>

Uplink Packet(HEX)

Channel	Type	Data Example	Unit
01	75(Battery Level)	64 => 100	%
03	94 (Light)	50 00 00 00 => 00 00 00 50 = 80	lux
FF	01(Ursalink Protocol Version)	01=> V1.0	/
	09 (Hardware Version)	01 40=> V1.4	
	0a(Software Version)	01 14=> V1.14	
	0b(Power on Notification)	ff	
	0c(Power off Notification)	ff	
	0f(Device Type)	00 => Class A	
16 (Device SN)	64 10 90 82 43 75 00 01 =>Device SN is 6410908243750001		

Downlink Packet(HEX)

Channel	Type	Data Example	Unit
FF	03(Set Reporting Interval)	b0 04 => 04 b0 = 1200	s

8.Sensor Management via Ursalink Cloud

Ursalink cloud is a comprehensive platform that provides multiple services including device remote management and data visualization with the easiest operation procedures.

8.1 Ursalink Cloud Registration

Register and log in Ursalink Cloud.

Ursalink Cloud URL: <https://cloud.ursalink.com/login.html>

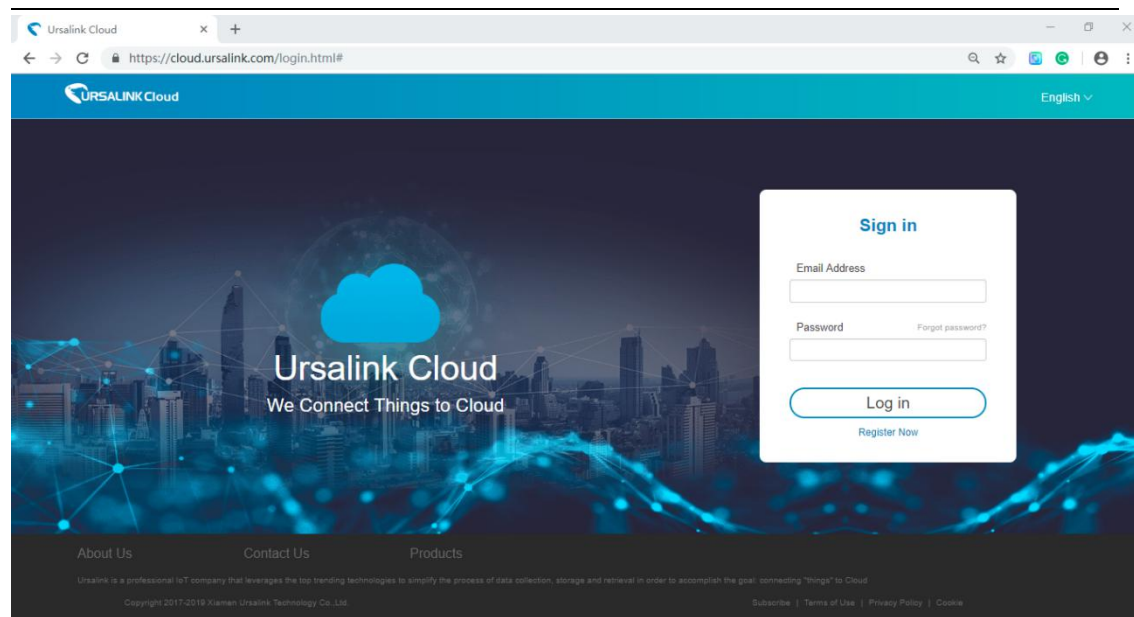

8.2 Add a Ursalink LoRaWAN Gateway

1. Enable “Ursalink” type network server and “Ursalink Cloud” mode in gateway web GUI.

Note: Ensure gateway has accessed the Internet.

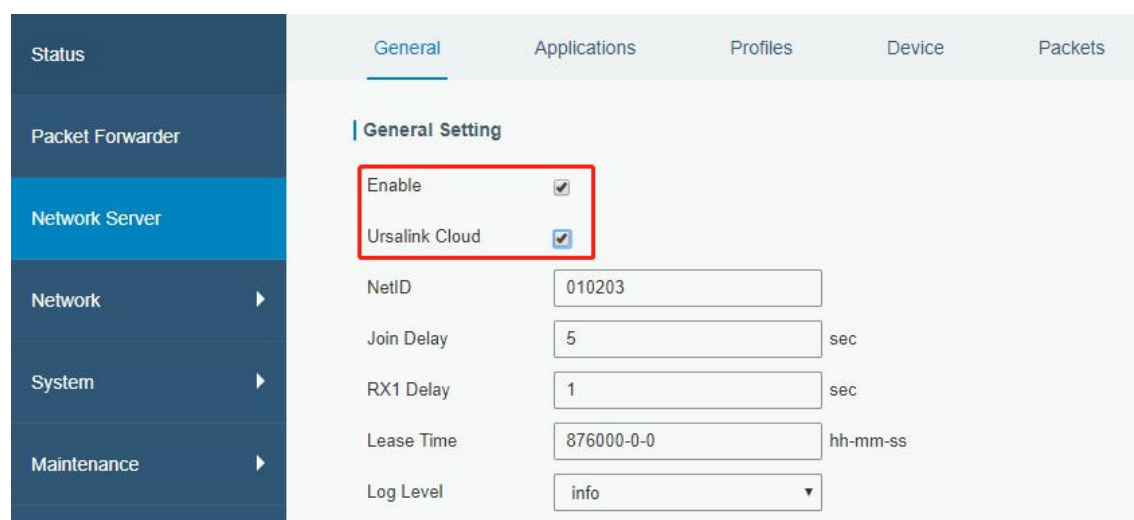
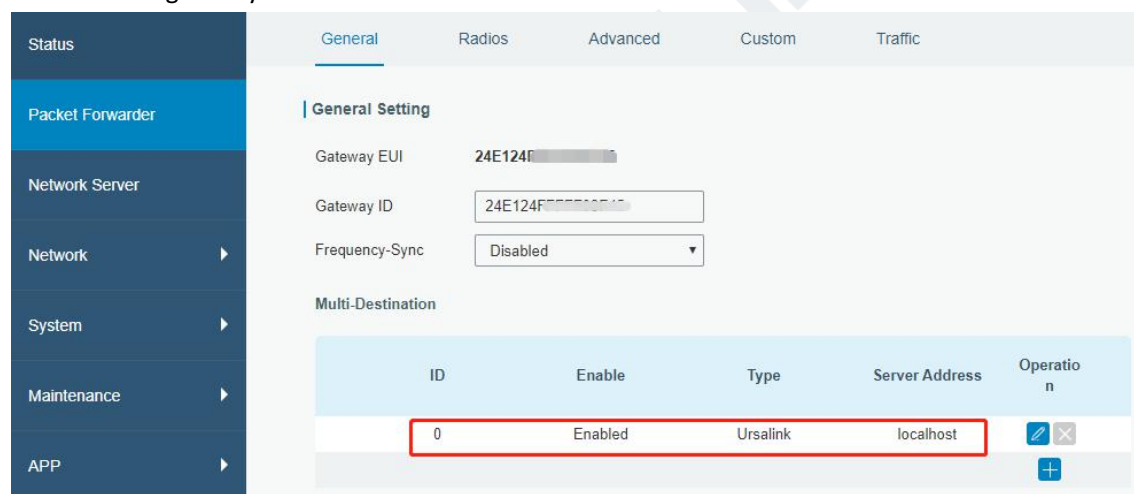

2. Go to “My Devices->Gateway” of Ursalink Cloud and click “Add” to add gateway to Ursalink Cloud via SN.

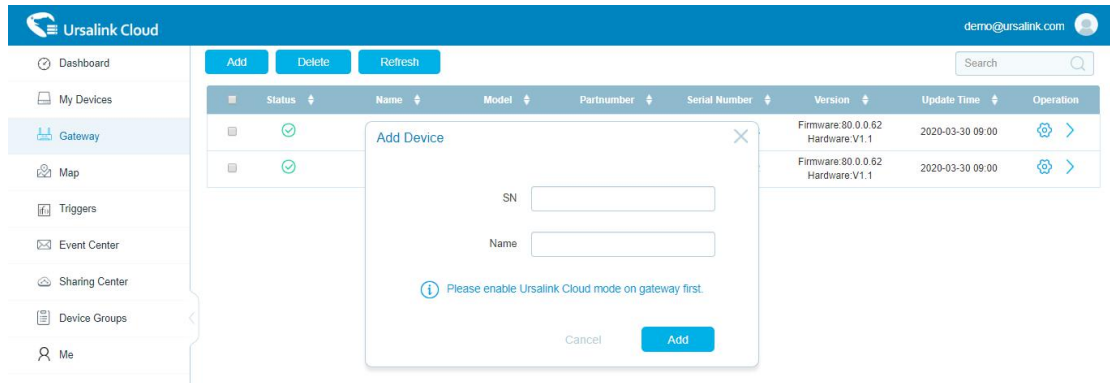

Status	Name	Model	Partnumber	Serial Number	Version	Update Time	Operation
✓					Firmware: 80.0.0.62 Hardware: V1.1	2020-03-30 09:00	⚙️ ➔
✓					Firmware: 80.0.0.62 Hardware: V1.1	2020-03-30 09:00	⚙️ ➔

3. Check if gateway is online in Ursalink Cloud.



Status	Name	Model	Partnumber	Serial Number	Version	Update Time	Operation
✓	231	UG85-L00E-EU868	L00E-EU868	621793195782	Firmware: 80.0.0.62 Hardware: V1.1	2020-03-30 09:00	⚙️ ➔
✓	621793195782	UG85-L01CE-CN470	L01CE-CN470	621793195782	Firmware: 80.0.0.62 Hardware: V1.1	2020-03-30 09:00	⚙️ ➔

8.3 Add EM500-LGT to Cloud

1. Go to “Device->My Devices” and click “Add Device”. Fill in the SN of EM500-LGT and select associated gateway.

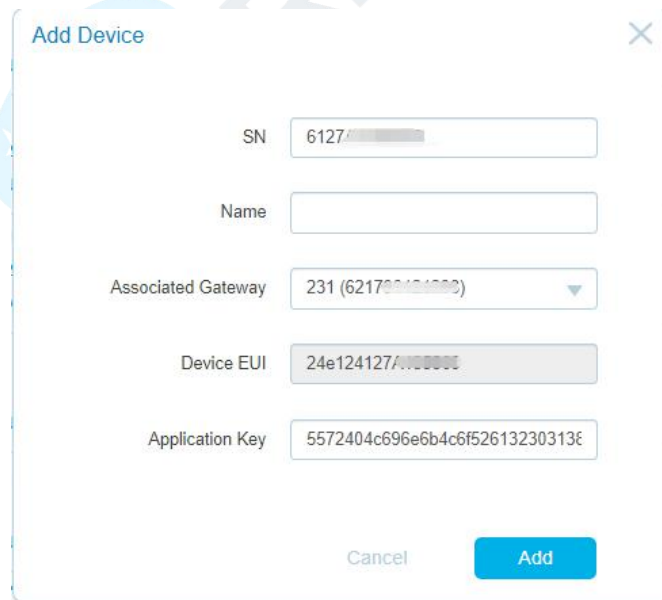

2. After EM500-LGT is connected to Ursalink Cloud, Click  or “History Data” to check the data on Ursalink cloud.



Appendix

Default LoRaWAN Parameters

DevEUI	24E124 + 2 nd to 11 th digits of SN e.g. SN = 61 26 A1 01 84 96 00 41 Then Device EUI = 24E124126A101849
AppEUI	24E124C0002A0001
Appport	0x55
NetID	0x010203
DevAddr	The 5 th to 12 th digits of SN e.g. SN = 61 26 A1 01 84 96 00 41 Then DevAddr = A1018496
AppKey	5572404C696E6B4C6F52613230313823
NwkSKey	5572404C696E6B4C6F52613230313823
AppSKey	5572404C696E6B4C6F52613230313823

Default Uplink Channels

Model	Channel Plan	Channel Settings/MHz
EM500-LGT-433	EU433	433.175, 433.375, 433.575
EM500-LGT-470	CN470	470.3~489.3 (All 95 channels)
EM500-LGT-868	EU868	868.1, 868.3, 868.5
EM500-LGT-915	AU915	915.2~927.1 (All 72 channels)

-END-