

OPC UA I/O User Manual

V4.0, 2021/09

U-7500 Series IIoT OPC UA I/O Module



U-7555M



U-7560M



U-7504M



U-7526M

Technical support: service@icpdas.com

Technical Editor: Tim Chen

Editor: Eva Li

Warranty

All products manufactured by ICP DAS are under warranty regarding defective materials for a period of one year, beginning from the date of delivery to the original purchaser.

Warning

ICP DAS assumes no liability for any damage resulting from the use of this product. ICP DAS reserves the right to change this manual at any time without notice. The information furnished by ICP DAS is believed to be accurate and reliable. However, no responsibility is assumed by ICP DAS for its use, not for any infringements of patents or other rights of third parties resulting from its use.

Copyright

Copyright @ 2020 by ICP DAS Co., Ltd. All rights are reserved.

Trademark

The names used for identification only may be registered trademarks of their respective companies.

Contact US

If you have any problem, please feel free to contact us.

You can count on us for quick response.

Email: service@icpdas.com

For more product information please refer to website: <https://www.icpdas.com>

Revision History

This chapter provides revision history information to this document.

The table below shows the revision history.

Revision	Date	Description
V4.0	09/2021	<p>4th Version: Provide New Functions</p> <ol style="list-style-type: none"> 1. Add CH3.3 Rule Setting (Main new function: Logic) <ul style="list-style-type: none"> * CH4.5 Advanced Setting: add 4.5.3 Rule Setting * Setting the logic condition of I/O & Virtual points: IF, THEN, ELSE 2. Add CH3.4 Support RESTful API (Main new function) <ul style="list-style-type: none"> * Read/write the I/O & Virtual points via HTTP 3. Add CH4.5.2 Event Log <ul style="list-style-type: none"> * CH4.5 Advance Setting: add Event Log (provide log file download) 4. Add CH4.1.3 NTP time calibration 5. Strengthen information security protection functions (CH4.1.4) <ul style="list-style-type: none"> * Increase the password length (>6), including at least one uppercase, one lowercase letter and one number 6. Add CH4.1.5 HTTPS Web Server <ul style="list-style-type: none"> * Can upload certificate and private key 7. Add CH4.1.6 Firewall Setting <ul style="list-style-type: none"> * Allow/restrict remote device connection 8. CH4.1.7 Modify firmware update time: 60 seconds => 2 minutes
V3.0	03/2021	<p>3rd Version: Provide New Functions</p> <ol style="list-style-type: none"> 1. Change the Model/Series name: all UA-75xxM change to U-75xxM 2. Support to execute OPC UA and MQTT communication simultaneously (Emphasized in the file) 3. Add data security protection functions: <ul style="list-style-type: none"> * The user must change the default username/password after the first login to use other functions * Delete the general user's right to modify the OS account password * General communication uses AES 256 encryption algorithm and set to data encrypt for web pages * For security reasons, only the service ports required by the I/O modules are available, and the rest are not open. * It is forbidden to use ping: turn off this function so that others cannot scan the device to reduce the possibility of cyberattacks. * Add the software system maintenance function for the developer 4. The [Module Setting] independently becomes the main menu: <ul style="list-style-type: none"> * Move [I/O Setting] and [I/O Status] to under here (previously under the [System Setting]) * Add [Project File] function to download and upload the project

Revision	Date	Description
V2.0	09/2020	2 nd version: 1. Release new AIO models: UA-7504M/UA-7526M 2. Provide new function: Scaling
V1.0	06/2020	Initial issue 1. Release new DIO models: UA-7555M/UA-7560M 2. Provide OPC UA and MQTT communication functions

Content of Table

Revision History	3
Content of Table	5
1. UA I/O Introduction:	8
1.1 Introduction.....	8
1.2 Features	9
1.3 Selection Guide	10
1.4 Specifications.....	11
1.4.1 Software Specifications (Series Common).....	11
1.4.2 U-7555M Specifications	13
1.4.3 U-7560M Specifications	14
1.4.4 U-7504M Specifications	15
1.4.5 U-7526M Specifications	16
1.5 Wire Connections / Pin Assignments.....	17
1.5.1 U-7555M Wire Connections / Pin Assignments.....	17
1.5.2 U-7560M Wire Connections / Pin Assignments.....	18
1.5.3 U-7504M Wire Connections / Pin Assignments/Jumper Pic.....	19
1.5.4 U-7526M Wire Connections/Pin Assignments/Jumper Pic.....	20
1.6 Dimensions.....	21
1.6.1 U-7555M/U-7560M/U-7504M/U-7526M Dimensions.....	21
2. Quick Start: Hardware/Network Connection	22
2.1. Hardware Connection	22
2.1.1. Preparations for Devices	22
2.1.2. AI/AO Jumper Setting	22
2.1.3. Hardware Wiring	24
2.2. Network Connection	25
2.2.1. Connection by Factory Default Settings (For New UA).....	26
2.2.2. Connection by Utility Searching.....	29
3. Main Function Settings	33
3.1 Settings for Using OPC UA Connection.....	34
3.1.1 OPC UA Server Connection Settings (UA I/O).....	35
3.1.2 OPC UA Client Side: InduSoft Simple Application.....	36
3.1.3 Secure Encrypted Connection: OPC UA Certificate	37
3.2 Settings for Using MQTT Connection	38
3.2.1 Connecting to MQTT Broker	39

3.2.2 MQTT Client Setting of the UA I/O	40
3.2.3 Secure Encrypted Connection: MQTT Certificate	45
3.3 Rule Setting	46
Setting Steps:	46
3.4 RESTful API: Read and Write I/O and Virtual Point	50
What is Restful API?	50
Use RESTful with UA I/O	50
RESTful Description	52
4. Main Menu: Parameter Descriptions	55
4.1 Main Menu - System Setting	55
4.1.1 Overview	55
4.1.2 Network Setting	56
Network Setting (LAN)	56
Hostname Setting	57
4.1.3 Time Setting	58
Date and Time Display	58
NTP time calibration	59
Set the time manually	59
4.1.4 Account Setting	60
4.1.5 Web Server Setting	61
Http Web Server Setting	61
Https Web Server Setting	62
4.1.6 Firewall Setting	63
4.1.7 Firmware Setting	64
Restore Factory Setting	64
Update Firmware	66
Maintenance	68
4.2 Main Menu - Module Setting	69
4.2.1 I/O Setting	69
Digital Input	69
Digital Output	70
Analog Input	71
Analog Output	72
4.2.2 I/O Status	73

Digital Input	73
Digital Output.....	73
Analog Input	74
Analog Output	74
4.2.3 Project File.....	75
Download the file from device	75
Upload the file to the device	76
4.3 Main Menu - OPC UA Setting	77
4.3.1 Server Setting.....	78
4.3.2 Certificate	79
4.4 Main Menu – MQTT Setting.....	80
4.4.1 Connection Setting	80
4.4.2 Client Setting	81
4.4.3 Certificate	84
4.5 Main Menu – Advanced Setting	86
4.5.1 Scaling.....	86
4.5.2 Event Log	87
4.5.3 Rule Setting	89
5. Recovering Firmware Setting (Reset)	90
Appendix A. Menu Path Diagram Description	92
Appendix B. MQTT JSON Format of the UA I/O Series.....	93

1. UA I/O Introduction:

UA I/O series is a series of **OPC UA I/O modules**, also known as **U-7500**. The main model is **U-75xxM**. This series built-in provides the communication protocol functions of the Industrial Internet of Things (IIoT), including OPC UA Server and MQTT Client functions. It allows user to choose the network communication method according to the needs and environment, and directly transfer the value of the I/O channel to the cloud IT system or the field-side control system to read and write the I/O data.

1.1 Introduction

OPC UA I/O modules is a series of Ethernet I/O modules that built-in with the **OPC UA Server** and **MQTT Client** services. The OPC UA I/O module, also called **UA I/O** or **U-7500**, supports the OPC UA server and MQTT client function (can execute both communications at the same time.) in industrial networking communication. Users can choose the networking mode according to their needs and environment, to transmit the values of built-in I/O channels to the cloud IT system or field control system for reading and writing. Support Scaling. Let the analog signal be converted into a more readable value. Support logic function rule setting IF, THEN, ELSE, can set up logical condition/action for I/O and virtual point; and support RESTful API function, can read/write I/O and virtual point through HTTP.

UA I/O Series provides a Web-based User Interface (Web UI) to configure the module, control the output channels, monitor the connection, and I/O status via a normal web browser. It is easy, fast, and no extra APP needed.



1.2 Features

■ **Built-in OPC UA Server Service**

Compliance with IEC 62541 Standard. Provides functions of Active Transmission, Transmission Security Encryption (SSL/TLS), User Authentication (X.509 Certificates / Account password), Communication Error Detection and Recovery, etc. to connect SCADA or OPC UA Clients. Recommend to keep the maximum number of sessions within 3 connections.

■ **Built-in MQTT Client Service**

Build-in MQTT Client Service (Compliance with MQTT V.3.1.1 protocol). Provides functions of IoT Active M2M Transmission, QoS (Quality of Service), Retains Mechanism, Identity Authentication, Encryption, Last Will, etc.

■ **Support to Execute OPC UA and MQTT Communication Simultaneously**

■ **Support Scaling**

AI/O modules support Scaling. Let the analog signal be converted into a more readable value.

■ **Support logic function Rule Setting: IF, THEN, ELSE**

can set up logical condition/action for I/O and virtual point.

■ **Support RESTful API function**

Can read/write I/O and virtual point through HTTP.

■ **Built-in Web Server to Provide the Web User Interface**

UA I/O Series provides a Web-based User Interface (Web UI) to configure the module, control the output channels, monitor the connection, and I/O status via a normal web browser. It is easy, fast, and no extra APP needed.

■ **Built-in I/O Channels**

UA I/O series has built-in AI, AO, DI, or DO channels, which is convenient for users to choose different models according to different needs.

■ **2-port Ethernet Switch for Daisy-Chain Topology**

The cabling of Daisy-Chain Topology is much easier and total costs of cable and switch are significantly reduced.

■ **IEEE 802.3af-compliant Power over Ethernet (PoE)**

UA I/O follows IEEE 802.3af compliant Power over Ethernet (PoE) specification. It allows receiving power from PoE enabled network by Ethernet pairs. This feature provides greater flexibility and efficiency to simplify system design, save space, and reduce wirings and power sockets.

1.3 Selection Guide

U-7500 Series UA I/O Selection Guide:

U-7500 Series OPC UA I/O Module Selection Guide								
Module	AI		AO		DI		DO	
	Ch.	Type	Ch.	Type	Ch.	Type	Ch.	Type
U-7555M	-	-	-	-	8	Dry (Source), Wet (Sink,Source)	8	Open Collector (Sink)
U-7560M	-	-	-	-	6	Wet (Sink/Source)	6	Power Relay Form A (SPST N.O.)
U-7504M	4	±500mV, ±1V, ±5V, ±10V, 0~20mA, ±20mA, 4~20mA	4	0~5V, ±5V, 0~10V, ±10V, 0~20mA, 4~20mA	4	Dry (Source), Wet (Sink)	-	-
U-7526M	6	±500 mV, ±1V, ±5V, ±10V, 0~20mA, ±20mA, 4~20mA	2	0~5V, ±5V, 0~10V, ±10V, 0~20mA, 4~20mA	2	Dry (Source), Wet (Sink,Source)	2	Open Collector
U-7517M-10	10 / 20	±150mV, ±500mV, ±1V, ±5V, ±10V, ±20mA, 0~20mA, 4~20mA	-	-	-	-	-	-
U-7519ZM	8	±150mV, ±500mV, ±1V, ±5V, ±10V, ±20mA, 0~20mA, 4~20mA Thermocouple: J, K, T, E, R, S, B, N, C, L, M, LDIN43710	-	-	-	-	3	Open Collector (Sink)

1.4 Specifications

1.4.1 Software Specifications (Series Common)

UA I/O Software Specifications (Series Common)	
Protocol	
OPC UA Server	<ul style="list-style-type: none"> ● OPC Unified Architecture: 1.02 ● Core Server Facet ● Data Access Server Facet ● Method Server Facet ● UA-TCP UA-SC UA Binary ● User Authentication: <ul style="list-style-type: none"> - Anonymous - Username/Password - X.509 Certificate ● Security Policy: <ul style="list-style-type: none"> - None - Basic128Rsa15 (Sign, Sign & Encrypt) - Basic256 (Sign, Sign & Encrypt) ● Max. Session Connections: 3 ● Can Execute with MQTT Communication Simultaneously
MQTT Client	<ul style="list-style-type: none"> ● Connect to the MQTT Broker to read or control the I/O channel value by the publish/subscribe messaging mechanism. (MQTT Ver. 3.1.1; TLS Ver. 1.2) ● Can Execute with OPC UA Communication Simultaneously
Function	
Web Interface for Configuration	<ul style="list-style-type: none"> ● The system operation can be performed through the browser without installing software tools. ● Use AES 256 encryption algorithm to encrypt web page setting data for general communication. ● HTTPS upgrades the security of web communication.
Scaling	<ul style="list-style-type: none"> ● Convert the analog signal to a more readable value. ● Function is only available for modules with AI/O.
Security	<ul style="list-style-type: none"> ● Based on security considerations, only the service ports needed by the I/O modules are open up, and the rest are not open. ● Forbidden to use ping: turn off this function so that others cannot scan the device, so as to reduce the possibility of network attacks. ● Firewall settings, allowing specific IP to have permission to connect to the module

UA I/O Software Specifications (Series Common)	
RESTful API	<ul style="list-style-type: none"> ● User can read/write the I/O & Virtual points through HTTP.
Rule Setting	<ul style="list-style-type: none"> ● Provide simple logic condition rule setting, let UA I/O do automatic condition judgment and action control, to achieve simple intelligentization.
Event Log	<ul style="list-style-type: none"> ● When the I/O value changes, record the current I/O value for easy device tracking in the future.

1.4.2 U-7555M Specifications

System Specifications

CPU Module	
CPU	32-bit CPU (400 MHz)
Isolation	
Intra-module Isolation	2500 VDC
EMS Protection	
EFT (IEC 61000-4-4)	±2 kV for Power Line
ESD (IEC 61000-4-2)	±4 kV Contact for each terminal and ±8 kV Air for random point
Surge (IEC 61000-4-5)	±2 kV for Power Line
LED Indicators	
Status	1 x PoE Power 1 x System Running 1 x Ethernet Link/Act 16 x I/O Channel Status
Ethernet	
Ports	RJ-45 x 2, 10/100 Base-TX, Switch Ports (LED indicators)
PoE	Yes
Power	
Reverse Polarity Protection	Yes
Input Range	12 ~ 48 VDC
Consumption	3.7 W
Powered from PoE	Yes, IEEE 802.3af, Class 1
Powered from Terminal Block	Yes, 12 ~ 48 VDC
Mechanical	
Dimensions (mm)	97 x 120 x 42 (W x L x H)
Installation	Wall Mounting
Environmental	
Operating Temperature	-25 °C ~ +75 °C
Storage Temperature	-30 °C ~ +80 °C
Humidity	10 ~ 90% RH, Non-condensing

I/O Specifications

Digital Input/Counter	
Channels	8
Type	Dry + Wet Contact
Sink/Source (NPN/PNP)	Dry: Source Wet: Sink/Source
Wet Contact, On Voltage Level	+10 VDC to +50 VDC
Wet Contact, Off Voltage Level	+4 VDC Max.
Dry Contact, On Voltage Level	Close to GND
Dry Contact, Off Voltage Level	Open
Dry Contact, Effective Distance	500 M Max.
Max. Count	16-bit (65535)
Frequency	50 Hz
Min. Pulse Width	10 ms
Input Impedance	10 kΩ
Overvoltage Protection	+70 VDC
Digital Output	
Channels	8
Type	Isolated Open Collector
Sink/Source (NPN/PNP)	Source
Load Voltage	+10 VDC ~ +40 VDC
Max. Load Current	650 mA/Channel at 25°C
Overvoltage Protection	47 VDC
Short-circuit Protection	Yes

1.4.3 U-7560M Specifications

System Specifications

CPU Module	
CPU	32-bit CPU (400 MHz)
Isolation	
Intra-module Isolation	2500 VDC
EMS Protection	
EFT (IEC 61000-4-4)	±2 kV for Power Line
ESD (IEC 61000-4-2)	±4 kV Contact for each terminal and ±8 kV Air for random point
Surge (IEC 61000-4-5)	±2 kV for Power Line
LED Indicators	
Status	1 x PoE Power 1 x System Running 1 x Ethernet Link/Act 16 x I/O Channel Status
Ethernet	
Ports	RJ-45 x 2, 10/100 Base-TX, Switch Ports (LED indicators)
PoE	Yes
Power	
Reverse Polarity Protection	Yes
Input Range	12 ~ 48 VDC
Consumption	3.8 W
Powered from PoE	Yes, IEEE 802.3af, Class 1
Powered from Terminal Block	Yes, 12 ~ 48 VDC
Mechanical	
Dimensions (mm)	97 x 120 x 42 (W x L x H)
Installation	Wall Mounting
Environmental	
Operating Temperature	-25 °C ~ +75 °C
Storage Temperature	-30 °C ~ +80 °C
Humidity	10 ~ 90% RH, non-condensing

I/O Specifications

Digital Input/Counter	
Channels	6
Type	Wet Contact
Sink/Source (NPN/PNP)	Sink/Source
Wet Contact, ON Voltage Level	+10 VDC ~ +50 VDC
Wet Contact, OFF Voltage Level	+4 VDC Max.
Max. Counts	16-bit (65535)
Frequency	50 Hz
Min. Pulse Width	10 ms
Input Impedance	10 kΩ
Overvoltage Protection	+70 VDC
Relay Output	
Relay Output	6
Type	Power Relay, Form A (SPST N.O.)
Contact Rating	5 A @ 250 VAC/24 VDC (Resistive Load)
Operate Time	10 ms (max.)
Release Time	5 ms (max.)
Electrical Endurance	100,000 ops.
Mechanical Endurance	20,000,000 ops.

1.4.4 U-7504M Specifications

System Specifications

CPU Module	
CPU	32-bit CPU (400 MHz)
Isolation	
Intra-module Isolation	2500 VDC
EMS Protection	
EFT (IEC 61000-4-4)	±2 kV for Power Line
ESD (IEC 61000-4-2)	±4 kV Contact for each terminal and ±8 kV Air for random point
Surge (IEC 61000-4-5)	±2 kV for Power Line
LED Indicators	
Status	1 x PoE Power 1 x System Running 1 x Ethernet Link/Act 12 x I/O Channel Status
Ethernet	
Ports	RJ-45 x 2, 10/100 Base-TX, Switch Ports (LED indicators)
PoE	Yes
Power	
Reverse Polarity Protection	Yes
Input Range	12 ~ 48 VDC
Consumption	5.1 W
Powered from PoE	Yes, IEEE 802.3af, Class 1
Powered from Terminal Block	Yes, 12 ~ 48 VDC
Mechanical	
Dimensions (mm)	97 x 120 x 42 (W x L x H)
Installation	Wall Mounting
Environmental	
Operating Temperature	-25 °C ~ +75 °C
Storage Temperature	-30 °C ~ +80 °C
Humidity	10 ~ 90% RH, Non-condensing

I/O Specifications

Analog Input	
Channels	4 (Differential)
Type	±500 mV, ±1 V, ±5 V, ±10 V +0 mA ~ +20 mA, ±20 mA, 4 ~ 20 mA(Jumper Selectable)
Resolution	16-bit
Accuracy	±0.1%
Sampling Rate	10 Samples/Second (Total)
Input Impedance	Voltage: 2 MΩ Current: 125 Ω
Common Mode Rejection	86 dB Min.
Normal Mode Rejection	100 dB
Common Voltage Protection	±200 VDC
Overvoltage Protection	240 Vrms
Overcurrent Protection	Yes, 50 mA Max. at 110 VDC/ VAC Max
Individual Channel Configuration	Yes
Channel-to-Channel Isolation	Yes, ±400 VDC
Open Wire Detection	Yes, for 4 ~ 20 mA only
Zero Drift	±20 μV/°C
Span Drift	±25 ppm/°C
Analog Output	
Channels	4
Type	+0 VDC ~ +5 VDC, ±5 VDC, +0 VDC ~ +10 VDC, ±10 VDC +0 mA ~ +20 mA, +4 mA ~ +20 mA (Jumper Selectable)
Resolution	12-bit
Accuracy	±0.1% of FSR
Open Wire Detection	Yes, for 4 ~ 20 mA only
Voltage Output Capability	20 mA @ 10 V
Current Load Resistance	400 Ω
Digital Input/Counter	
Channels	4
Type	Dry + Wet Contact
Wet Contact, ON Voltage Level	+1 VDC Max.
Wet Contact, OFF Voltage Level	+3.5 VDC ~ + 30 VDC
Dry Contact, ON Voltage Level	Close to GND
Dry Contact, OFF Voltage Level	Open
Dry Contact, Effective Distance	500 M Max.
Max. Count	16-bit (65535)
Frequency	50 Hz
Min. Pulse Width	10 ms
Overvoltage Protection	+30 VDC

1.4.5 U-7526M Specifications

System Specifications

CPU Module	
CPU	32-bit CPU (400 MHz)
Isolation	
Intra-module Isolation	2500 VDC
EMS Protection	
EFT (IEC 61000-4-4)	±2 kV for Power Line
ESD (IEC 61000-4-2)	±4 kV Contact for each terminal and ±8 kV Air for random point
Surge (IEC 61000-4-5)	±2 kV for Power Line
LED Indicators	
Status	1 x PoE Power 1 x System Running 1 x Ethernet Link/Act 12 x I/O Channel Status
Ethernet	
Ports	RJ-45 x 2, 10/100 Base-TX, Switch Ports (LED indicators)
PoE	Yes
Power	
Reverse Polarity Protection	Yes
Input Range	12 ~ 48 VDC
Consumption	4.4 W
Powered from PoE	Yes, IEEE 802.3af, Class 1
Powered from Terminal Block	Yes, 12 ~ 48 VDC
Mechanical	
Dimensions (mm)	97 x 120 x 42 (W x L x H)
Installation	Wall Mounting
Environmental	
Operating Temperature	-25 °C ~ +75 °C
Storage Temperature	-30 °C ~ +80 °C
Humidity	10 ~ 90% RH, Non-condensing

I/O Specifications

Analog Input	
Channels	6 (Differential)
Type	±500 mV, ±1 V, ±5 V, ±10 V, ±20 mA, 0 ~ 20 mA, 4 ~ 20 mA (Jumper Selectable)
Resolution	16-bit
Accuracy	±0.1%
Sampling Rate	Voltage: 2 MΩ Current: 125 Ω
Input Impedance	Close to GND
Common Mode Rejection	86 dB Min.
Normal Mode Rejection	100 dB
Common Voltage Protection	±200 VDC
Overvoltage Protection	240 Vrms
Overcurrent Protection	Yes, 50 mA Max. at 110 VDC/VAC Max
Individual Channel Configuration	Yes
Channel-to-Channel Isolation	Yes, ±400 VDC
Open Wire Detection	Yes, for 4 ~ 20 mA only
Zero Drift	±20 μV/°C
Span Drift	±25 ppm/°C
Analog Output	
Channels	2
Type	0 ~ 5 VDC, ± 5 VDC, 0 ~ 10 VDC, ± 10 VDC 0 ~ 20 mA, 4 ~ 20 mA (Jumper Selectable)
Resolution	12-bit
Accuracy	±0.1% of FSR
Open Wire Detection	Yes, for 4 ~ 20 mA only
Voltage Output Capability	20 mA @ 10 V
Current Load Resistance	500 Ω
Digital Input/Counter	
Channels	2
Type	Dry + Wet Contact
Sink/Source (NPN/PNP)	Dry: Source Wet: Sink/Source
Wet Contact, ON Voltage Level	+1 VDC Max.
Wet Contact, OFF Voltage Level	+3.5 VDC ~ + 30 VDC
Dry Contact, ON Voltage Level	Close to GND
Dry Contact, OFF Voltage Level	Open
Dry Contact, Effective Distance	500 M Max.
Max. Count	16-bit (65535)
Frequency	50 Hz
Min. Pulse Width	10 ms
Overvoltage Protection	+70 VDC
Digital Output	
Channels	2
Type	Isolated Open Collector
Sink/Source (NPN/PNP)	Sink
Load Voltage	+5 VDC ~ +50 VDC
Max. Load Current	700 mA/Channel
Overvoltage Protection	60 VDC
Overload Protection	1.4 A
Short-circuit Protection	Yes

1.5 Wire Connections / Pin Assignments

1.5.1 U-7555M Wire Connections / Pin Assignments

Wire Connections

Digital Input/Counter	Readback as 1	Readback as 0
	+10 ~ +50 Vdc	OPEN or <4 Vdc
Wet Contact (Sink)		
Wet Contact (Source)		

Pin Assignments

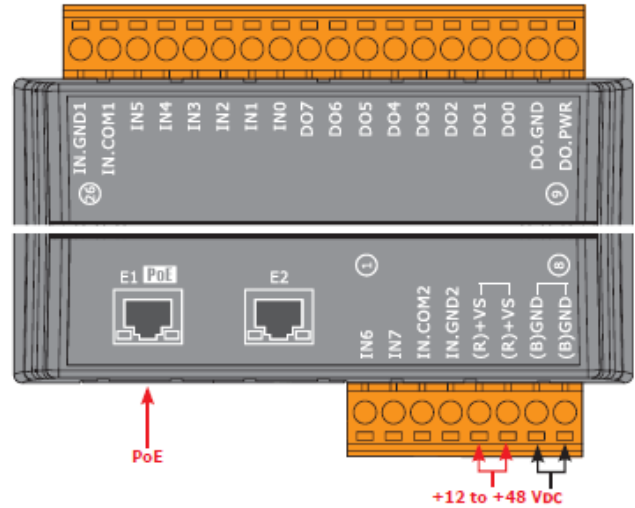

Digital Input/Counter	ON State Readback as 1	OFF State Readback as 0
Dry Contact		

Digital Output	ON State Readback as 1	OFF State Readback as 0
Source		

1.5.2 U-7560M Wire Connections / Pin Assignments

Wire Connections

Digital Input/Counter	Readback as 1	Readback as 0
Sink	+10 ~ +50 Vdc 	OPEN or <4 Vdc
Source	+10 ~ +50 Vdc 	OPEN or <4 Vdc
Power Relay	ON State: Readback as 1	
Relay Output		
	OFF State: Readback as 0	
Relay Output		

Pin Assignments

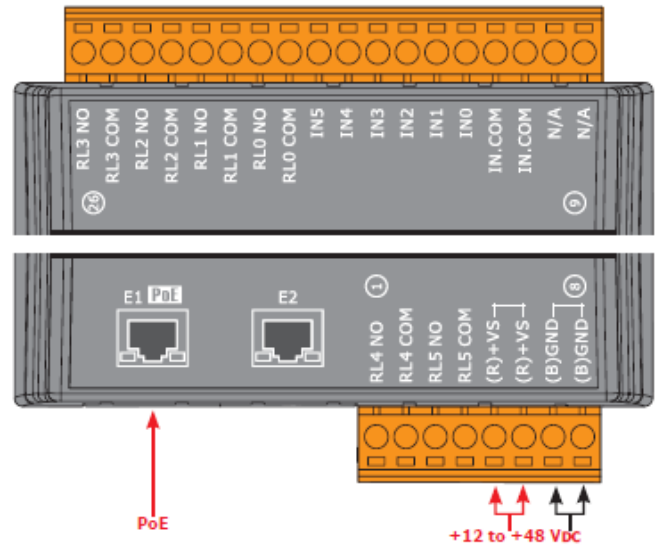

1.5.3 U-7504M Wire Connections / Pin Assignments/Jumper Pic

Wire Connections

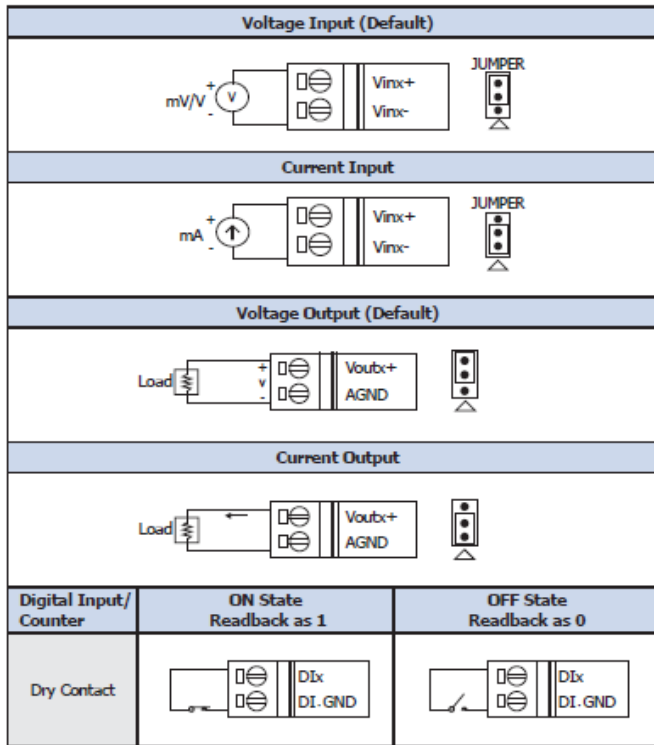

Jumper Location

UA-7504M								
Channel	Vin3	Vin2	Vin1	Vin0	Vout3	Vout2	Vout1	Vout0
Jumper	J4	J3	J2	J1	J8	J7	J6	J5
Location	Jumper →							

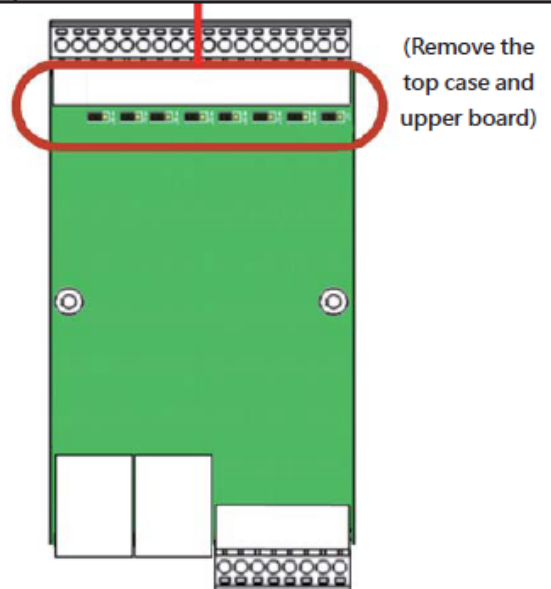

Pin Assignments

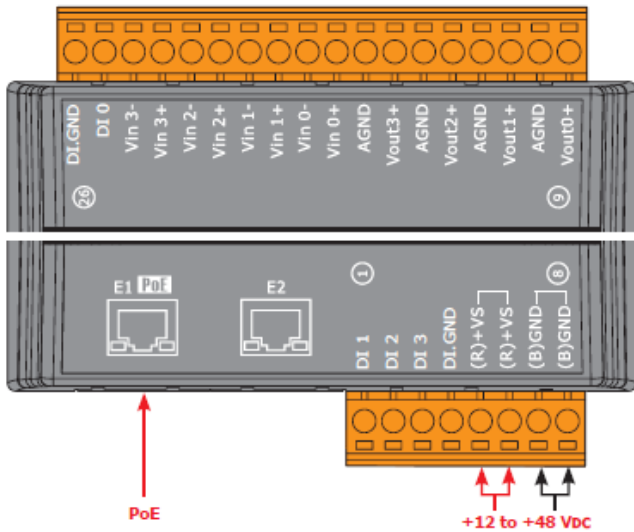

1.5.4 U-7526M Wire Connections/Pin Assignments/Jumper Pic

Wire Connections

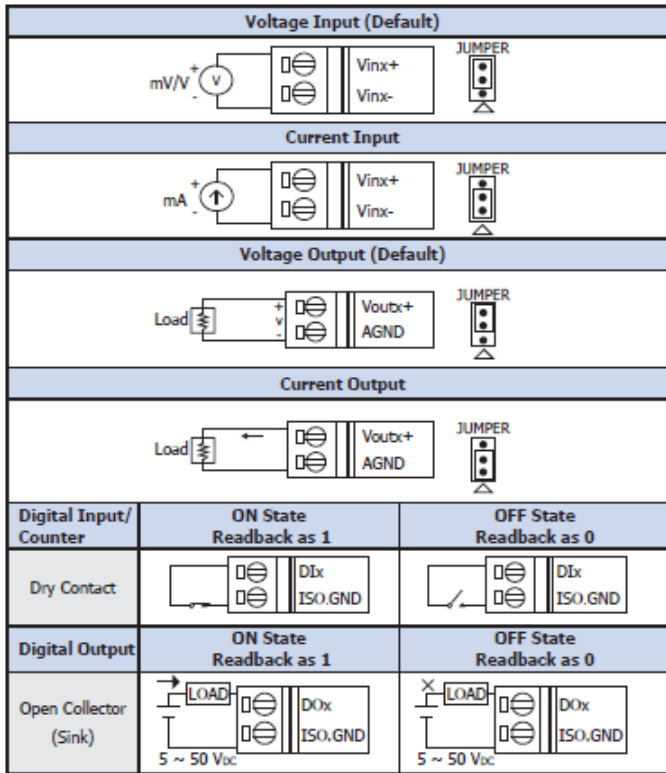

Jumper Location

UA-7526M								
Channel	Vout1	Vout0	Vin5	Vin4	Vin3	Vin2	Vin1	Vin0
Jumper	J8	J7	J6	J5	J4	J3	J2	J1
Location	Jumper →							

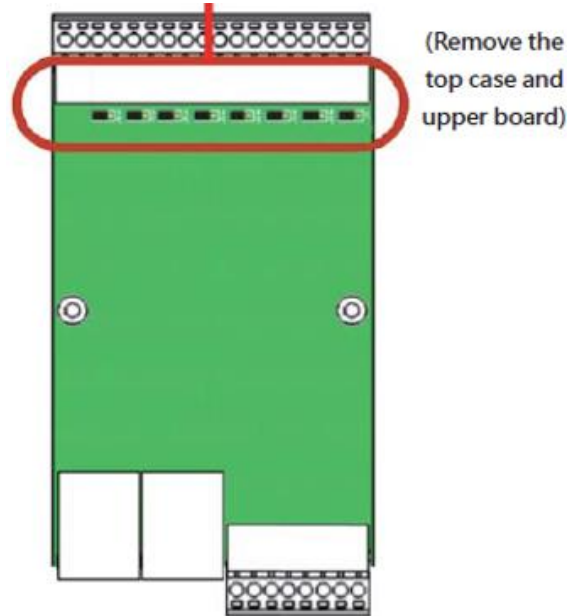

Pin Assignments

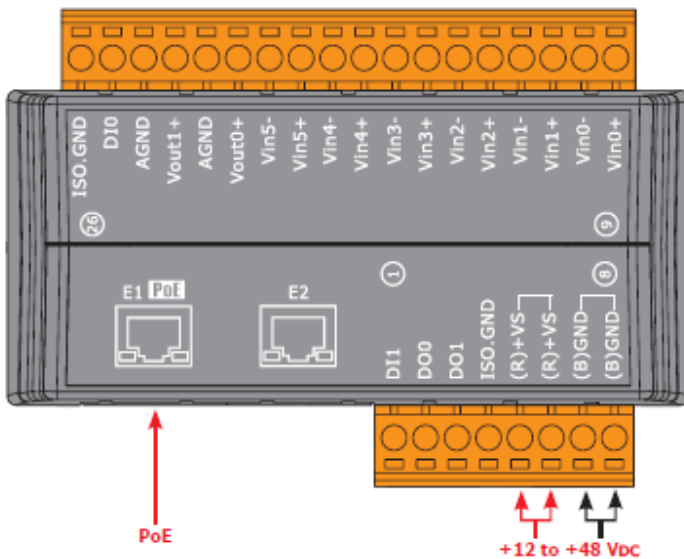

1.6 Dimensions

1.6.1 U-7555M/U-7560M/U-7504M/U-7526M Dimensions

(Unit: mm)

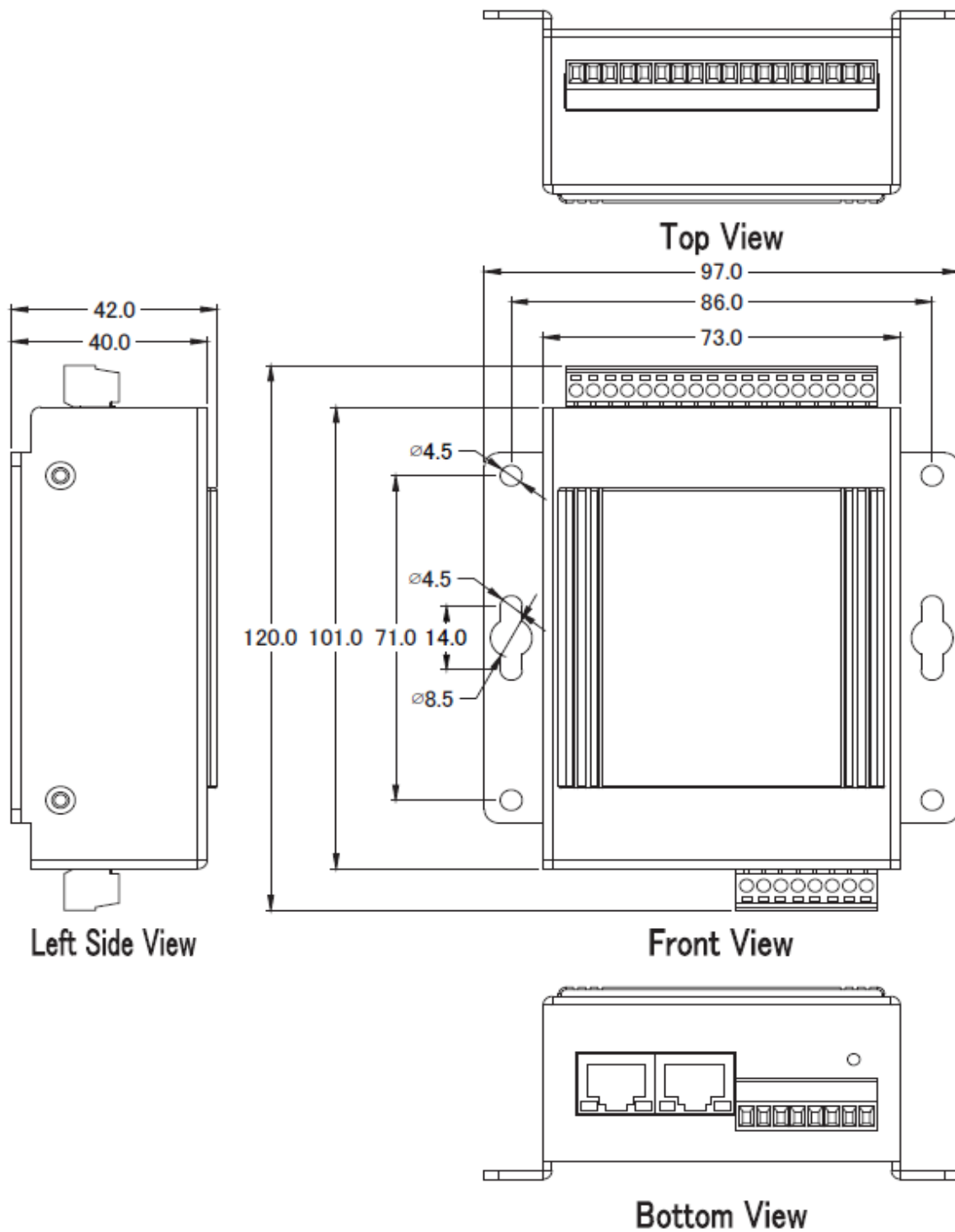

2. Quick Start: Hardware/Network Connection

This chapter describes the UA I/O module’s hardware connection, network connection and quick setting. For how to set up a project via the Web UI on the browser, please refer to Chapter 3.

2.1. Hardware Connection

This section describes the hardware wiring and connection for the UA I/O module.

2.1.1. Preparations for Devices

In addition to the UA I/O modules (Ex: U-7555M), please prepare the following:

1. **PC/NB:** Can connect to the network and set the network
2. **Ethernet Switch/Hub:** e.g. NS-205 or **PoE Switch** NSM-208SE
3. **Power Supply:** +12 ~ +48 VDC, e.g. MDR-60-24 (If using PoE Switch, user can save a power supply.)

2.1.2. AI/AO Jumper Setting

This section is for setting the AI/AO jumpers, if use DI/O module, please go to the next section.

Setting the Selection Jumpers for Analog channels:

1. **Remove the top case and upper board** of the module if need to change the selection jumper, the selection jumpers are next to the connector.
2. Set up the **Jumper** corresponding to the type of **voltage/current and input/output** for each analog channel.

Voltage/Current Input/output Selection Jumper: (Default as AI/AO: Voltage/Voltage)

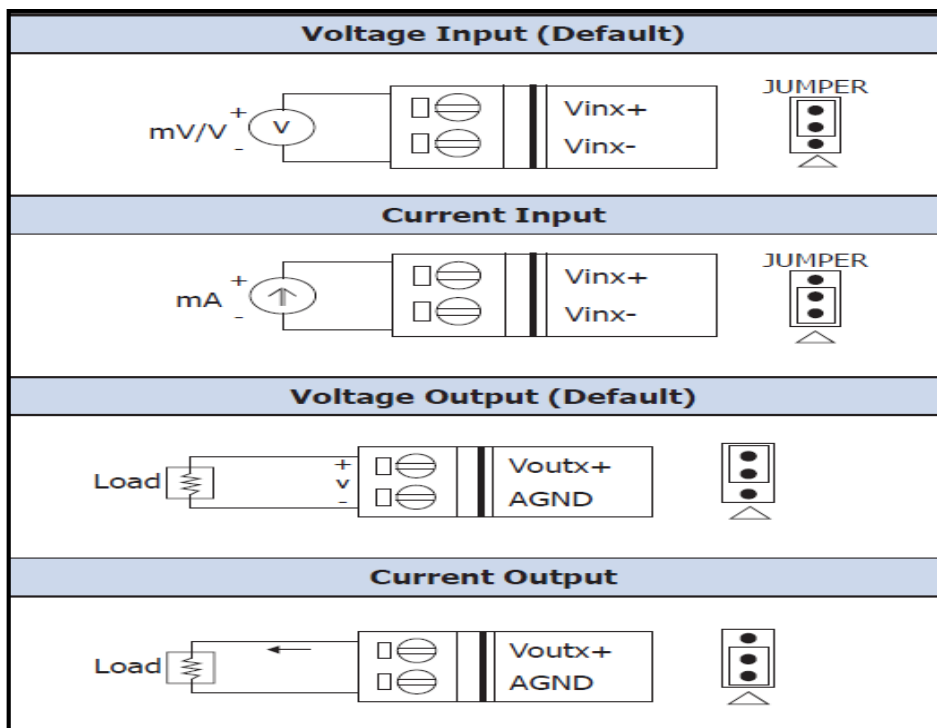

Jumper Location:

U-7504M								
Channel	Vin3	Vin2	Vin1	Vin0	Vout3	Vout2	Vout1	Vout0
Jumper	J4	J3	J2	J1	J8	J7	J6	J5

U-7526M								
Channel	Vout1	Vout0	Vin5	Vin4	Vin3	Vin2	Vin1	Vin0
Jumper	J8	J7	J6	J5	J4	J3	J2	J1

Jumper Direction 

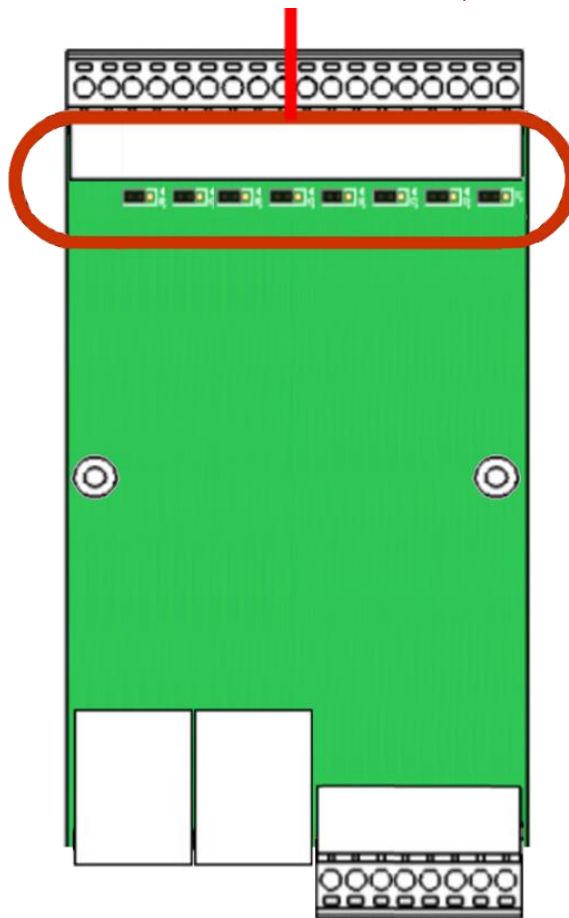

(Jumpers default as:
 Input: Voltage
 Output: Voltage.

 If you need to change the
 jumpers, remove the top case
 and upper board first.)

2.1.3. Hardware Wiring

Connect the U-7500 I/O Module with the RJ-45 Ethernet port to an Ethernet switch/hub and PC (**Fig.1**). Beside, U-7500 support PoE (Power over Ethernet). If using the PoE switch, do not need one more power supply (**Fig.2 for PoE Switch**). You can also directly link the U-7500 to PC with an Ethernet cable.

After power is connected, please **【wait 1 minute】** for U-7500 start-up procedure. When the "RUN" light starts flashing, it represents the boot is complete.

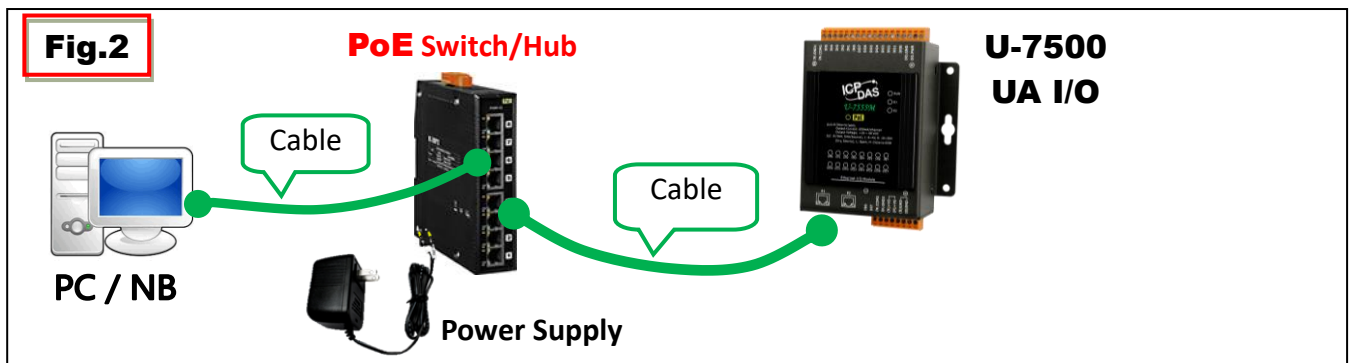
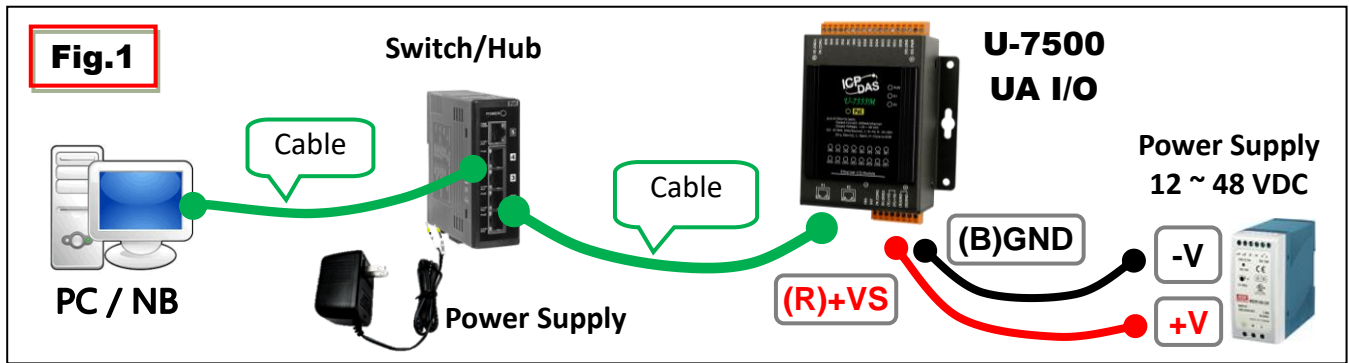

2.2. Network Connection

This section introduces 3 methods to connect to the **UA I/O Web UI** (User Interface).

Setting new UA I/O module or the new user please uses the **method A** in the **Chapter 2.2.1** (The same method as the “UA I/O Quick Start” document.). Other users please see the following introductions to choose method B or C.

The methods to login the UA I/O Web UI:

A. Using Factory Default Setting:

Suitable for setting a new UA I/O module and the PC network IP is not in the same domain with UA I/O. This method changes the PC network IP to be the same domain with the network IP of the UA I/O factory default values to login the Web UI. (Refer [Chapter 2.2.1](#))

B. Using Software Utility:

Suitable for quick setting when many UA I/O are in the network but the IP are unknown. UA products provide a free software utility for auto searching UA products in the network and can quick jump to the login web page of UA. (Refer [Chapter 2.2.2](#))

C. Using IP Address:

Suitable for the UA has a fixed IP and in the same domain with the PC. If the UA has a fixed IP and in the same domain with the PC, users can directly enter the IP in the address bar of a web browser and log in to the Web UI of the UA.

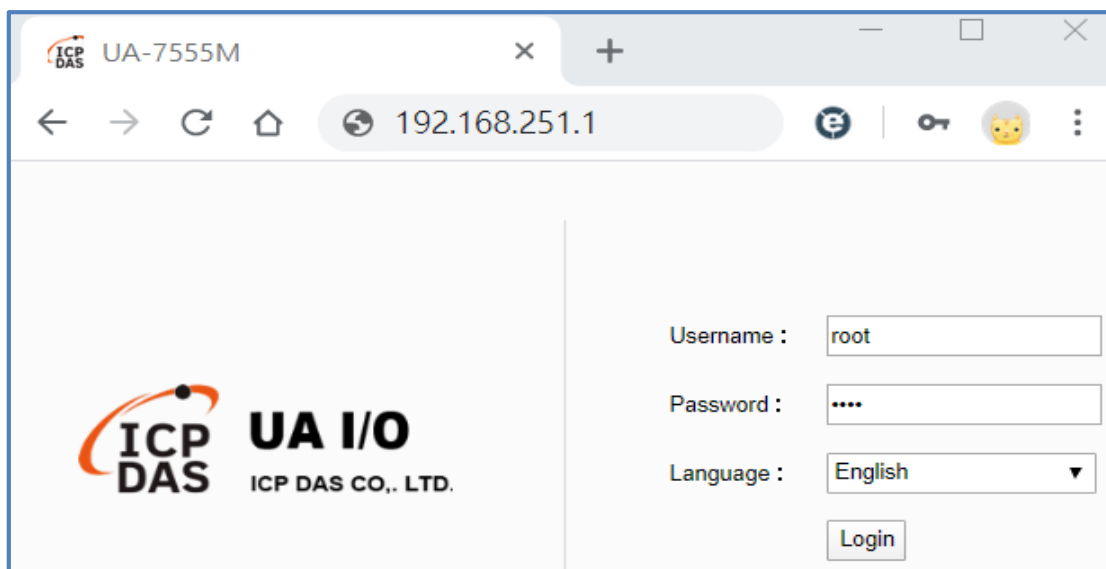

After login the UA I/O Web UI, then can set up the UA project.

2.2.1. Connection by Factory Default Settings (For New UA)

The factory default settings of the UA I/O series are as the following table:

Factory Default Settings of UA I/O Modules			
Network	IP	192.168.255.1	Assign U-7500 a new IP setting according to your case.
	Netmask	255.255.0.0	
	Gateway	192.168.1.1	
Web UI Account	Username	root	After the first login, change the default username/password to use other functions.
	Password	root	

1. Change the **PC's IP** setting as following. (**Write down the PC original network settings before modify.**)

IP	192.168.255.10
Subnet mask	255.255.0.0
Gateway address	192.168.1.1

2. Make sure the PC and UA I/O is connecting through Ethernet. Then open a PC side browser (Ex: Chrome, IE...).

Type **http://192.168.255.1** in the URL address. Use Web UI **default username / password "root" / "root"** to login the system.

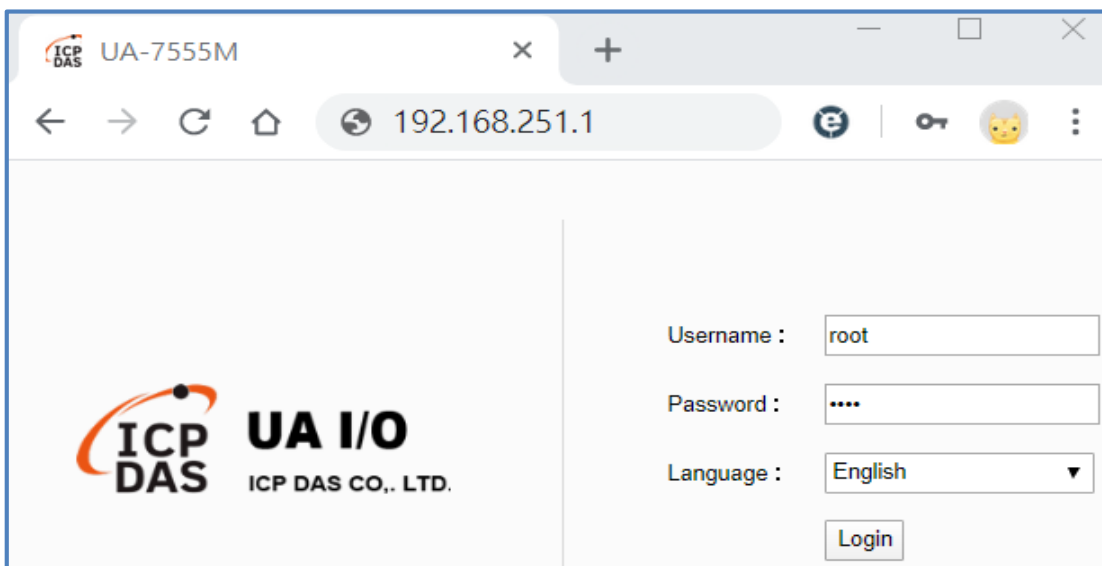

3. Click 【System Setting】 → 【Account Setting】 , change the Username/password first, or user cannot use any other function (New design for data security).

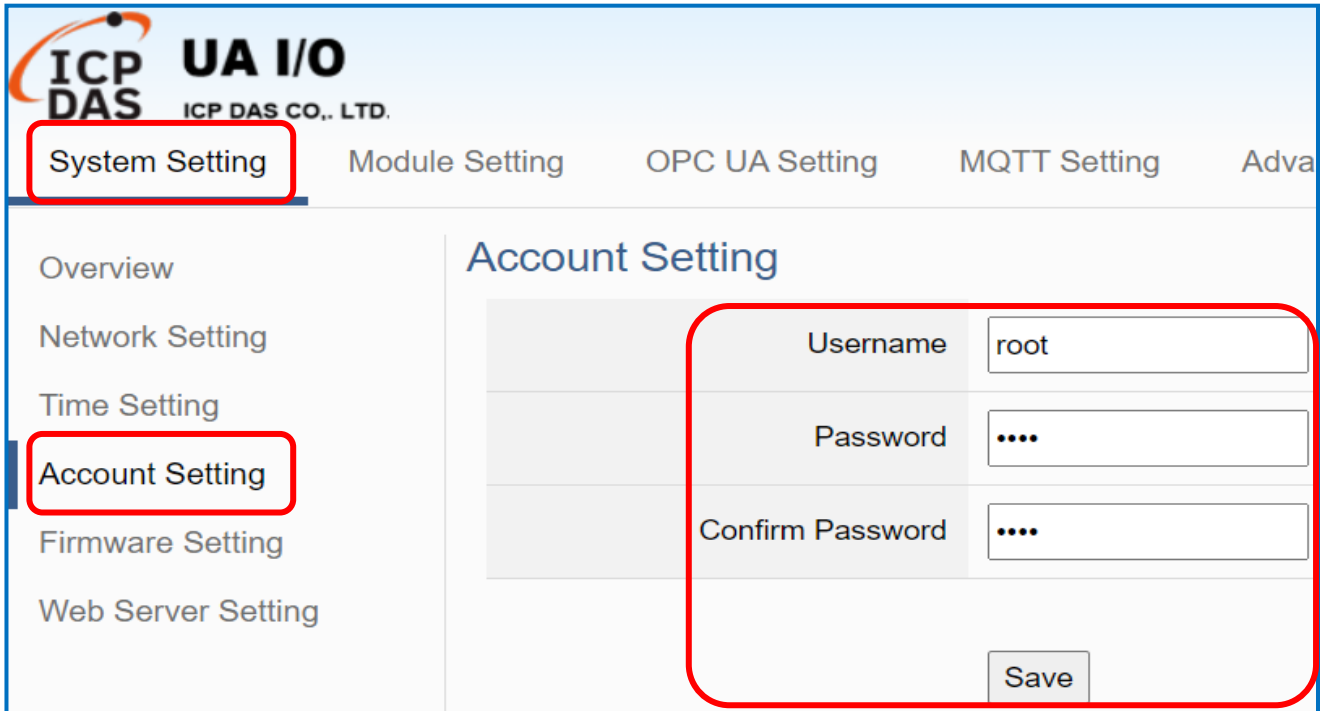

Password Setting rules:

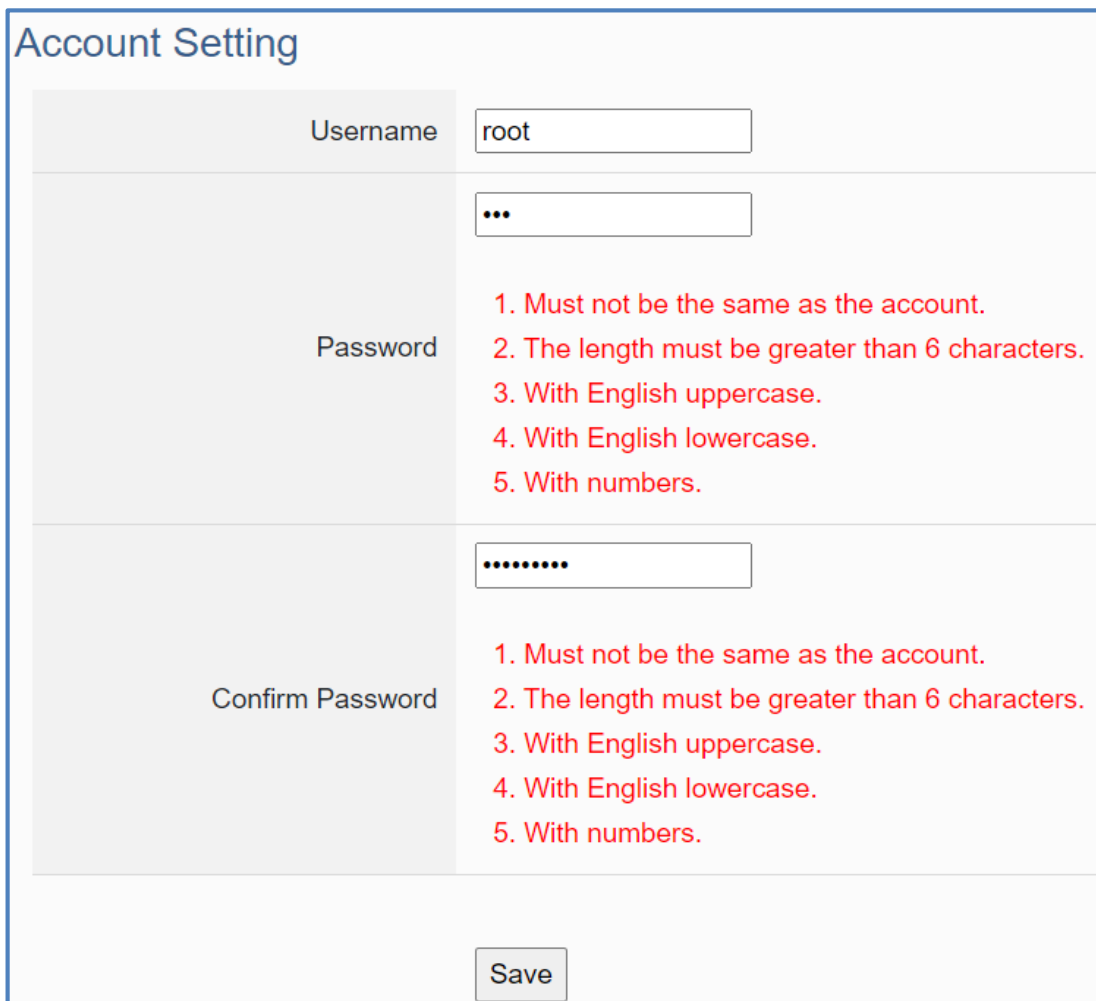

- Click **【System Setting】** → **【Network Setting】** → **【Network Setting(LAN1)】** to change the IP setting by user network.

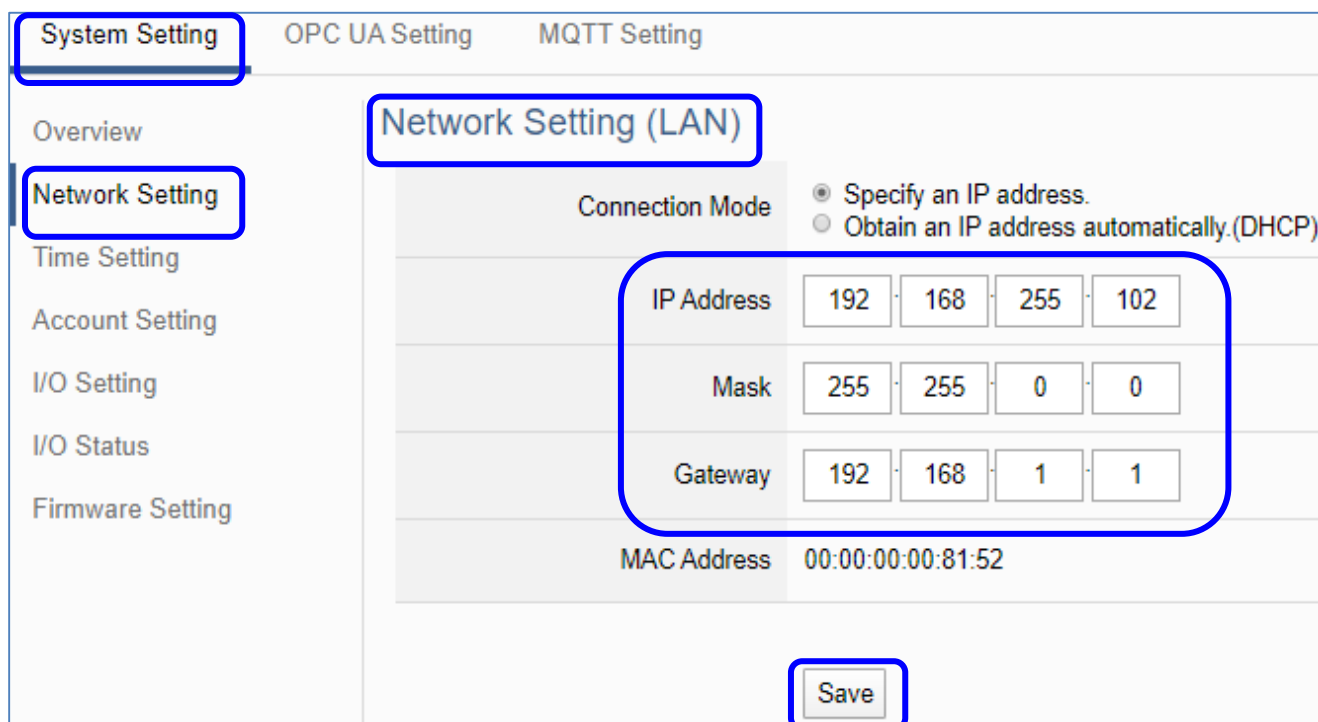

- Save the IP setting, restore the PC original IP settings, and type the new IP in the browser as step-2 to login the Web UI of UA I/O. Then configure user's UA project.

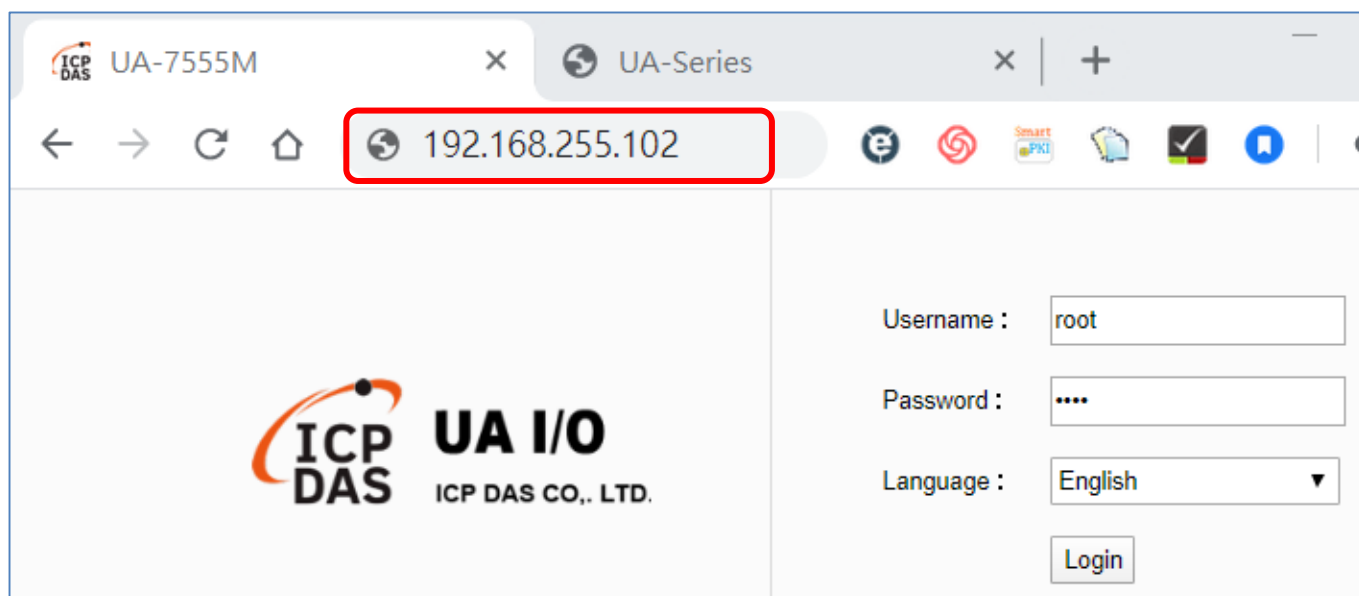

2.2.2. Connection by Utility Searching

Setting new UA I/O or the new user please uses the method in the [Chapter 2.2.1](#). (Method A)

If the UA I/O has a fixed IP and in the same domain as the PC, users can directly enter the IP in the address bar of a web browser and log in to the Web UI of the UA. (Method C)

This section introduces the 2nd method(B) that users use the UA Utility to search the Network IP. This method is suitable for connecting multiple UA series controllers or I/O modules to the Internet, but the IP addresses of UA are unknown or need to modify the UA quickly.

UA Utility is a free tool software to quickly search each UA series on the network and connect to its Web UI for setting UA series products and project.

In the PC, install the **UA Utility** (named “**ua-series_utility.exe**”), and then run it to connect the device. Please download the utility program from the website:

<https://www.icpdas.com/en/download/index.php?nation=US&kind1=6&kind2=17&model=&kw=ua->

Utility & Tools				
FILE NAME	DESCRIPTION	MODEL	LAST UPDATE	DETAIL
UA-Series Utility	Utility For all UA-Series IIoT Communication Server & I/O modules		2020-05-22	

1. Install and execute the Utility

Run the UA Utility (file name: **UA-series_utility.exe**) to install the Utility program.

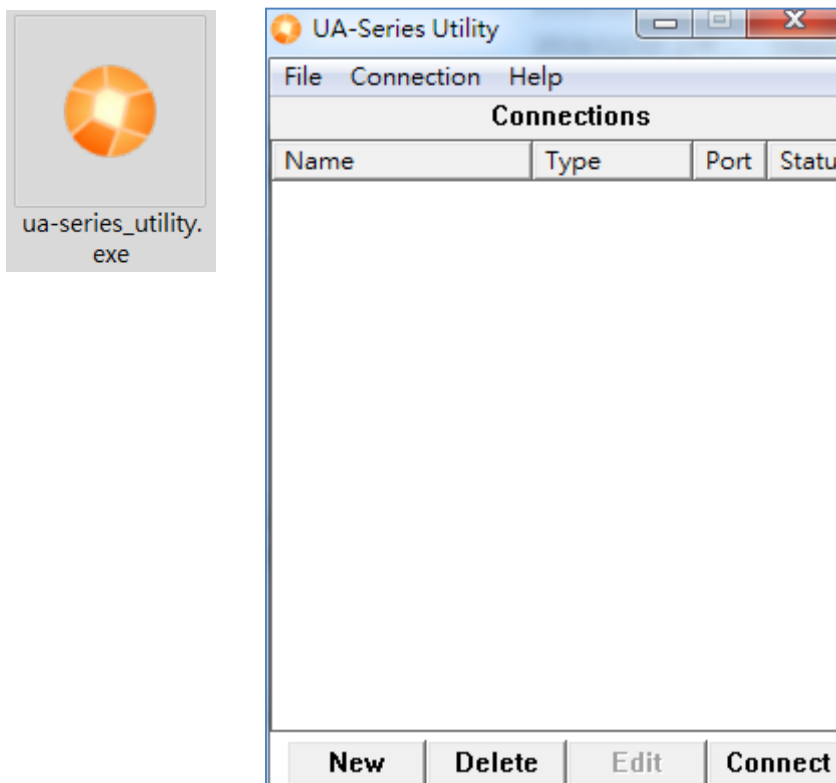

2. Create a new connection

Click “New” to add a connection item and give a name for it.

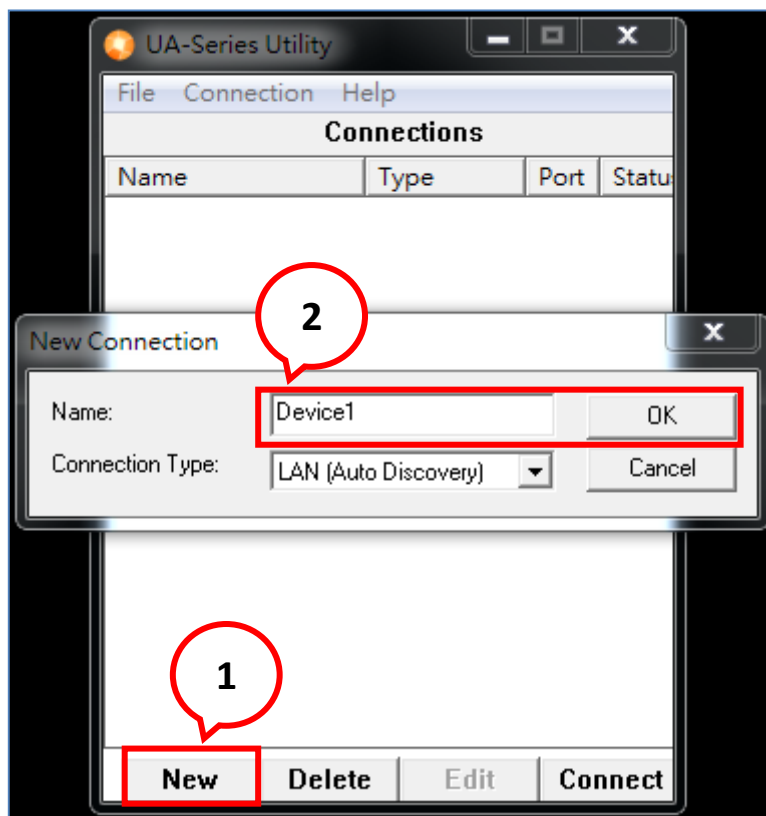

3. Search the UA controller

Mouse double-click on the name you created (or single-click and then click the “Connect” button), this utility will scan and list all UA devices over the network.

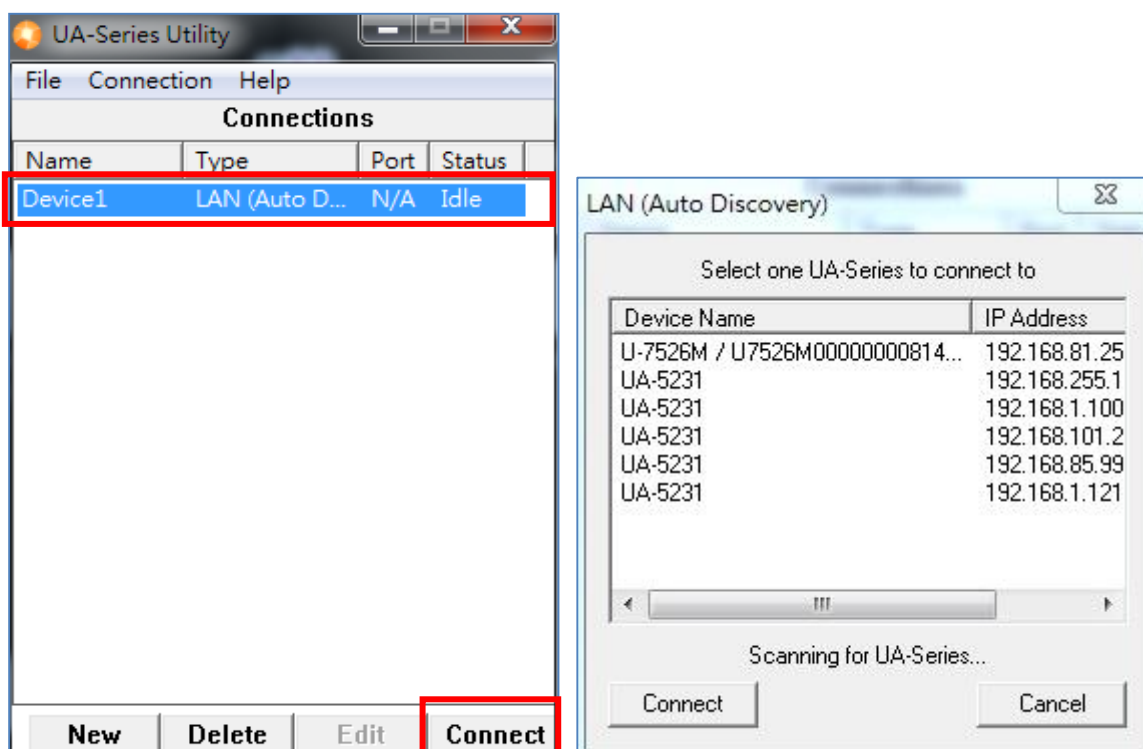

4. Connect to the UA Device

Click the device name you want to connect to, and then click the “**Connect**” button. It will connect to the UA webpage via the default Web browser (IE/Chrome...).

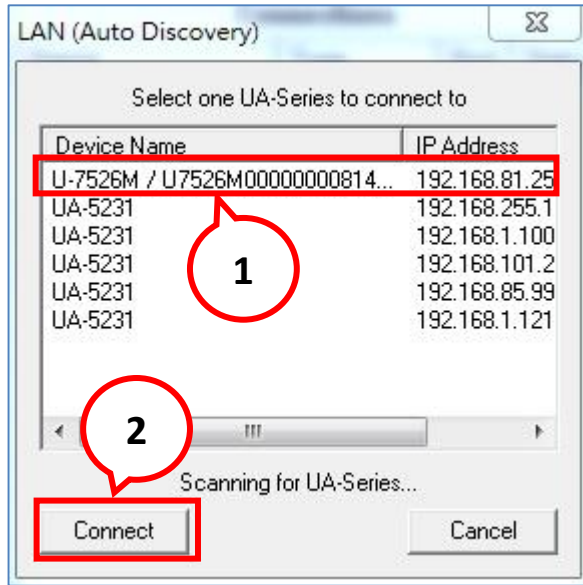

5. Connection to the UA Web UI

The default web browser will be run and direct go to the UA login web site.

Please enter the username and password to login the UA Web UI.

The factory default username: **root**. The factory default password: **root**. After login in, change the default Username/password first, or user cannot use any other function (New design for data security).

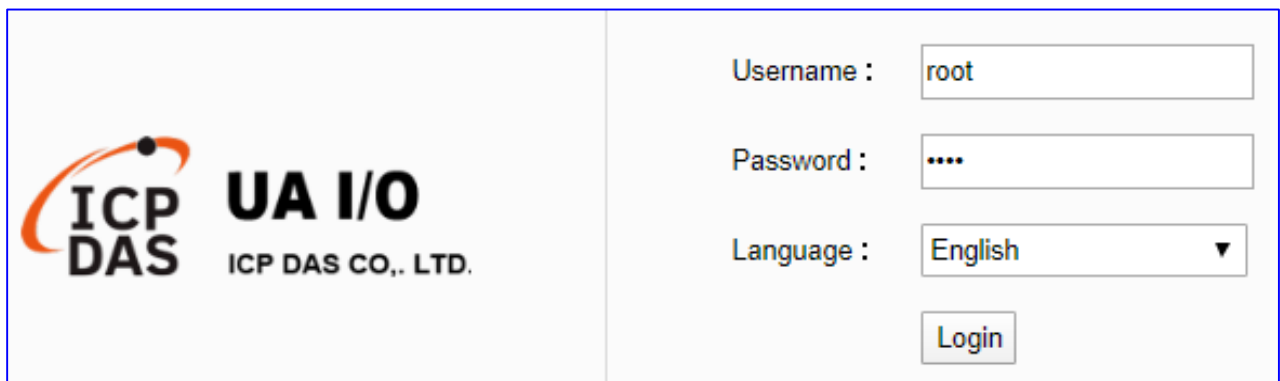

6. Login the Web UI of the UA I/O Series

When login into the web interface, the UA default home page (the main configuration screen) will as below, and will automatically read setting of that UA to the webpage.

The screenshot displays the ICP DAS UA I/O web interface. At the top left is the logo for ICP DAS UA I/O, ICP DAS CO., LTD. Below the logo are navigation tabs: System Setting (selected), Module Setting, OPC UA Setting, MQTT Setting, and Advanced Setting. On the left side, there is a vertical menu with options: Overview (selected), Network Setting, Time Setting, Account Setting, Web Server Setting, Firewall Setting, and Firmware Setting. The main content area is divided into two sections. The upper section is a table with the following data:

Firmware Version	5.0.0.0
Factory Version	6.5
MAC Address	00:0d:e0:b0:f0:03

The lower section is a bar chart titled "Hardware Usage Rate". The y-axis represents the usage rate from 0 to 100. The x-axis lists three hardware components: CPU, Memory, and Disk. The bars show the following usage rates: CPU is approximately 40%, Memory is approximately 58%, and Disk is approximately 52%.

3. Main Function Settings

This chapter introduces some of the most important and commonly used functions of UA I/O and their setting steps.

OPC UA I/O modules is a series of Ethernet I/O modules that built-in with the **OPC UA Server** and **MQTT Client services**. The OPC UA I/O module, also called UA I/O or U-7500, supports the OPC UA server and MQTT client function in industrial networking communication. Users can choose the networking mode according to their needs and environment, to transmit the values of built-in I/O channels to the cloud IT system or field control system for reading and writing. So, the main functions are the OPC UA connection and the MQTT connection. This chapter will introduce them first. Each function can be divided into the settings for the Server/Broker and Client, and how to enable secure encrypted communication, and how to download/upload the secure certificates. In addition, the AI/AO, DI/DO function applications are also very important for the UA I/O, which will be added to this chapter soon.

OPC UA / MQTT Communication Advantages: (V.S. traditional Modbus Communication)

Support Identity Authentication

Identity Authentication			
ICP DAS UA Solution	OPC UA	ID/Password, Anonymous, Certificate	Yes
	MQTT	ID/Password, Anonymous	
Traditional	Modbus	None	

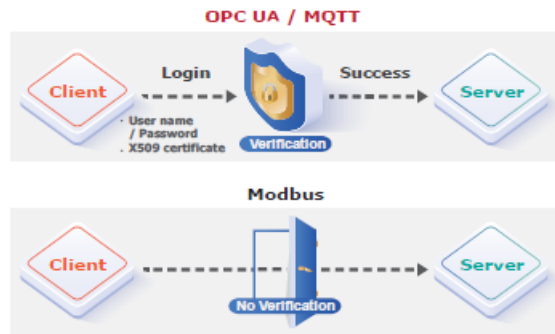

Support Data Encryption

Data Encryption			
ICP DAS UA Solution	OPC UA	SSL/TLS Encryption	Yes
	MQTT	SSL/TLS Encryption	
Traditional	Modbus	None	

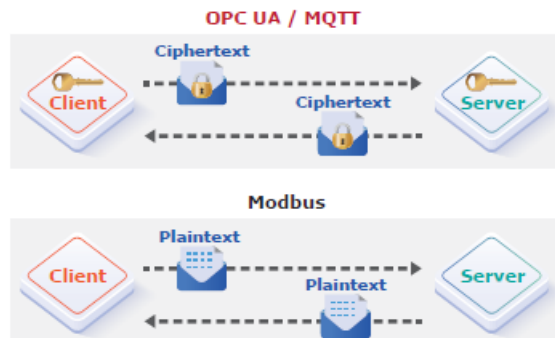

Active Data Transmission

Data Transmission			
ICP DAS UA Solution	OPC UA	Active (Server sends Data to the Client)	Active
	MQTT	Active (Client publishes Data to Broker, and the Broker sends Data to other Clients)	
Traditional	Modbus	Passive Request/Response (Wait for Master to poll the Data)	

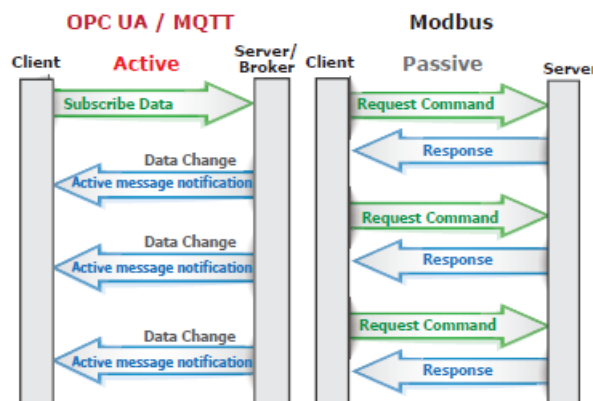

3.1 Settings for Using OPC UA Connection

This section introduces how to set up the OPC UA communication service of UA I/O, and recommends compatible ICP DAS products.

UA I/O module built-in OPC UA Server Service that compliance with IEC 62541 Standard. Provides functions of Active Transmission, Transmission Security Encryption (SSL/TLS), User Authentication (X.509 Certificates / Account password), Communication Error Detection and Recovery, etc. to connect SCADA or OPC UA Clients. Recommend to keep the maximum number of sessions within 3 connections.

OPC UA connection includes the following settings that will be introduced in 3 sub-sections.

1. **OPC UA Server** Connection Settings (UA I/O)
2. **OPC UA Client** I/O Settings (Recommend to use the InduSoft product of ICP DAS.)
3. How to **enable secure encrypted function**, and download/upload the encrypted certificates

OPC UA Architecture and Advantages of the UA I/O:

OPC UA Architecture:



Comparison Table of ICP DAS UA I/O Module & Traditional I/O Module

	ICP DAS UA I/O Module		Traditional I/O Module
Protocol	OPC UA Server	MQTT Client	Modbus TCP Slave
IP Setting	Static IP	Static or Dynamic(DHCP) IP	Static IP
Identity Authentication	Account ID/Password, Anonymous, Certificate Verification	Account ID/Password, Anonymous	None
Encryption	SSL/TLS	SSL/TLS	None
Data Transmission	Active (Actively sends Data to the Client)	Active (Actively publishes Data to Broker, and the Broker sends Data to other Clients)	Passive (Wait for Master to poll the Data: Query/Response)
Project Building	Via browse the Server Content	Via subscribe Topic from Broker	Manually assign an ID and define the Data address and type.

3.1.1 OPC UA Server Connection Settings (UA I/O)

UA I/O module built-in OPC UA Server function and itself is the Server side of the connection. So, when setting up the Server, you only need to set the connection port number and choose the login method (via anonymous, username, or certificate). Usually, the user will enable the username login method, so the user can set the username/password of the account besides.

1. Connection Setting

Click Main Menu 【OPC UA Setting】 → 【Server Setting】 → 【Connection Setting】 .

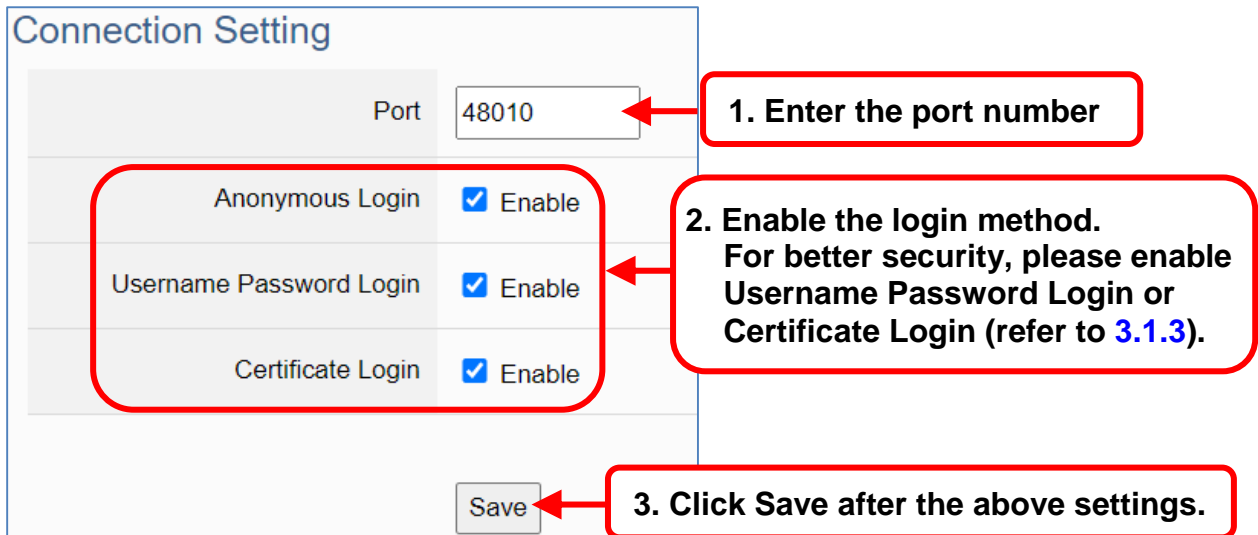

2. When enabling username password login, please set the account in the following menu path.

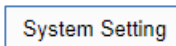
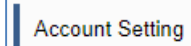
Menu Path:【System Setting】→【Account Setting】  →  ([Appendix A](#)).

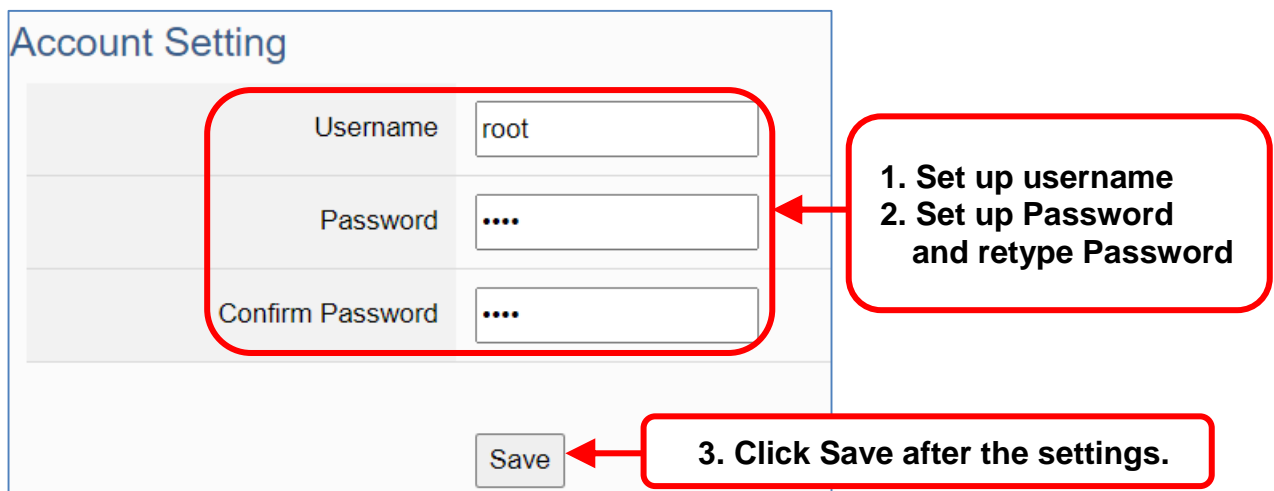

If users enable the secure and encrypted OPC UA **Certificate Login**, need to upload/download certificates, please refer to [Sec.3.1.3](#) .

After completing the Server connection settings, then set the **Client connection** (refer to [Sec.3.1.2](#)), and then can communicate with each other.

3.1.2 OPC UA Client Side: InduSoft Simple Application

After setting the OPC UA Server-side (UA I/O), you only need to configure the OPC UA Client for connection. Now, go to the Client device that connects with UA I/O, and set the corresponding data point. We recommend using ICP DAS InduSoft products as the Client device. It is easier to set up relatively and can connect to UA I/O faster. For detailed settings, please refer to the InduSoft manual.

The setting screen is as follows:

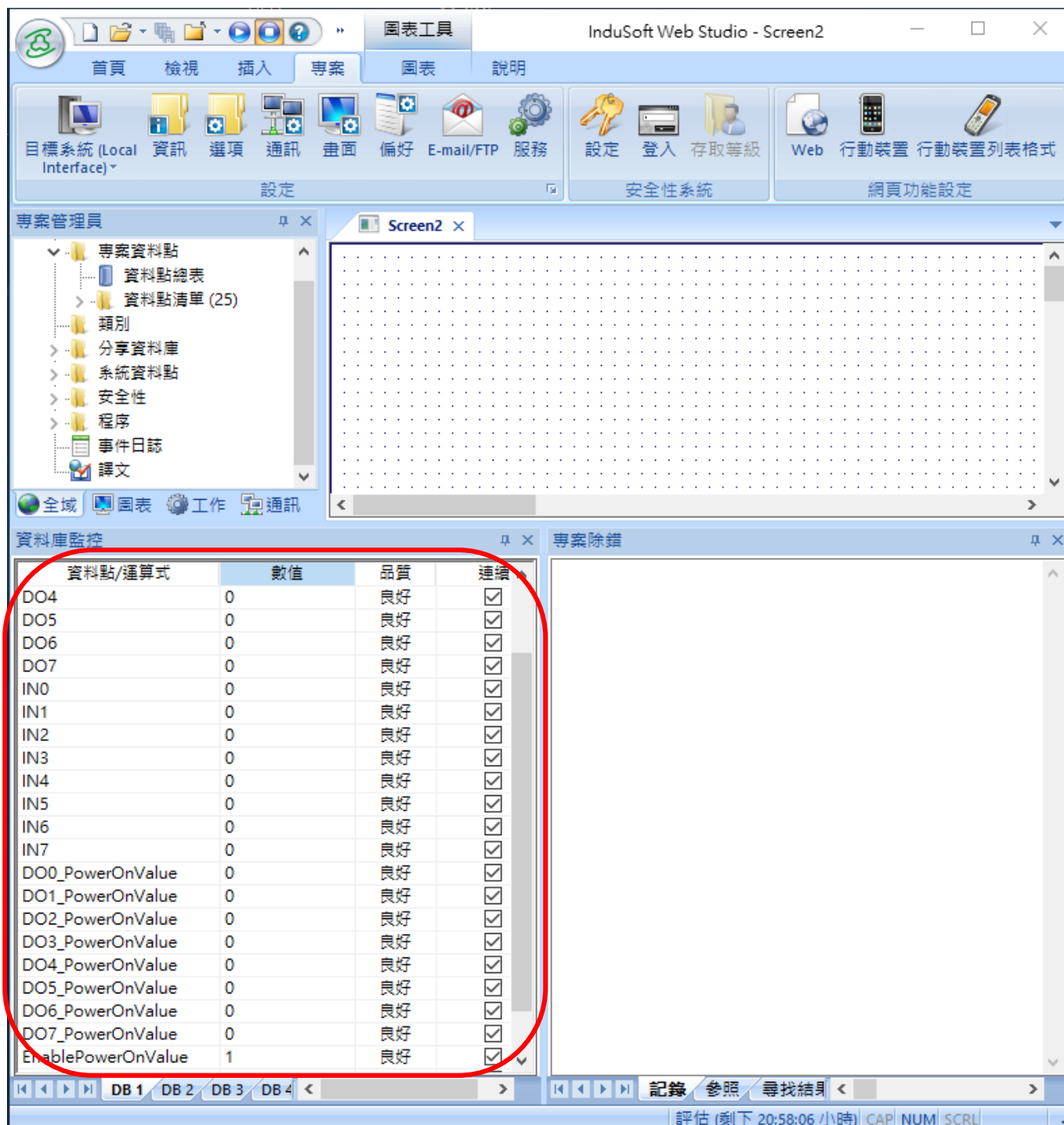

3.1.3 Secure Encrypted Connection: OPC UA Certificate

When using the OPC UA connection, in addition to the account login for security, users can also enable the certificate login to double the protection by the secure encryption. This section describes how to download/upload the certificates. If you do not want to enable the certificate login, please skip.

When enabling the OPC UA certificate login, the Server/Client both sides of the connection need to add certificates to each other's trust zones. This section will show how to do the steps.

Menu Path: 【OPC UA Setting】 → 【Certificate】 →  →  (Appendix A).

- A. **Provide the OPC UA Server Certificate of the UA I/O** to the Client device. That is, download the Server certificate file of the UA I/O, and then upload and import it into the software (or APP) of the OPC UA Client device.

Click the "Download" button to get the Certificate file generated by the Server.
File Name: icpdasuaserver.der

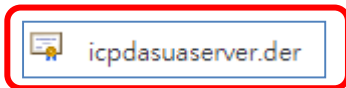
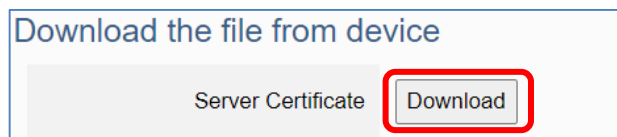

Import this file into OPC UA Client APP.

- B. **Get the Trusted Certificate file of the connected OPC UA Client**, save it in the PC, and upload it into the UA I/O module.

- 1) Click the "Upload" button to open the "open" window.

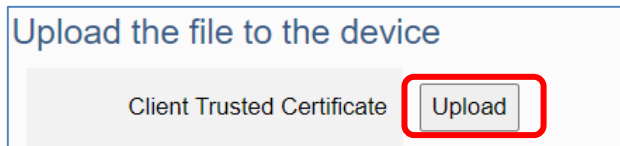

- 2) Select the Trusted Certificate file.

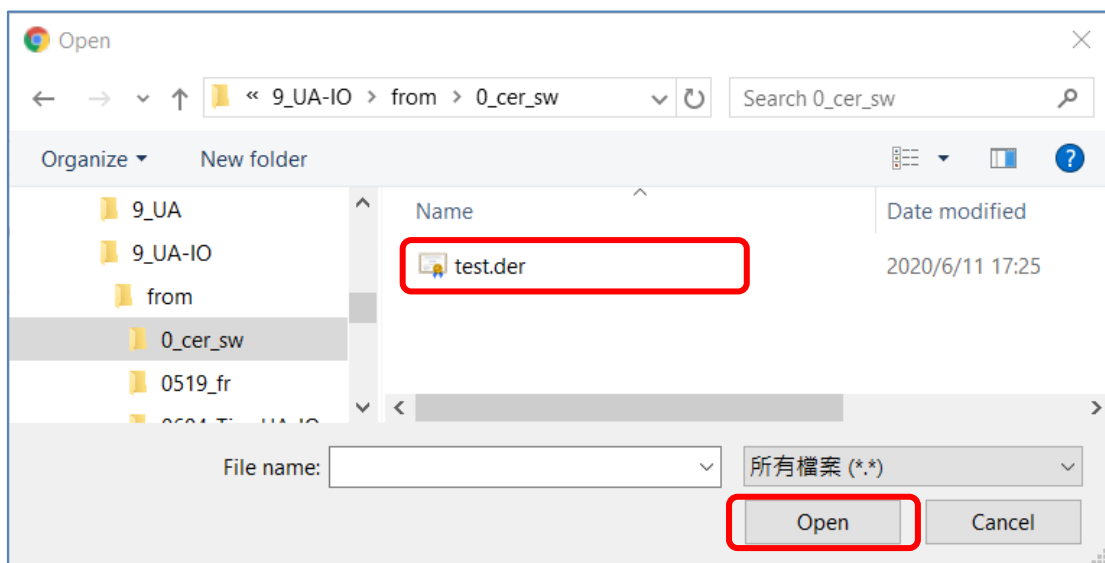

3.2 Settings for Using MQTT Connection

This section introduces how to set up the MQTT Client communication of UA I/O, and recommends the compatible ICP DAS products.

UA I/O module built-in MQTT Client Service (Compliance with MQTT V.3.1.1 protocol). Provides functions of IoT Active M2M Transmission, QoS (Quality of Service), Retains Mechanism, Identity Authentication, Encryption, Last Will, etc.

MQTT connection includes the following settings that will be introduced in 3 sub-sections.

1. **MQTT Broker Connection** Settings (Recommend the UA-2xxx/52xx & BRK series of ICP DAS)
2. **MQTT Client** side I/O Settings (UA I/O)
3. How to **enable secure encrypted function**, and download/upload the encrypted certificates

MQTT Architecture and Advantages of the UA I/O:

MQTT Architecture:

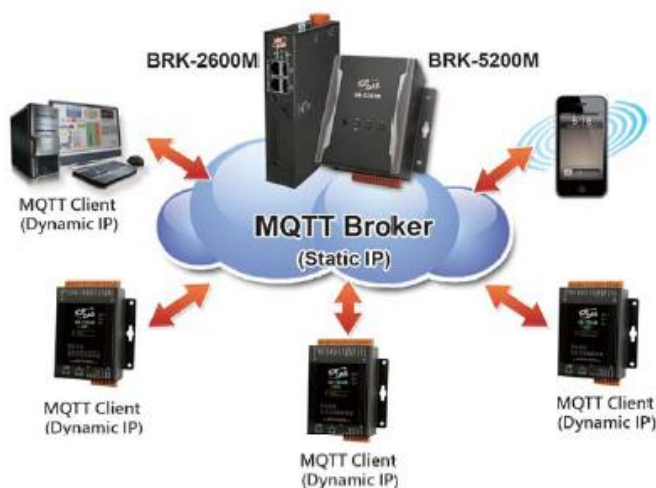

Comparison Table of ICP DAS UA I/O Module & Traditional I/O Module

	ICP DAS UA I/O Module		Traditional I/O Module
Protocol	OPC UA Server	MQTT Client	Modbus TCP Slave
IP Setting	Static IP	Static or Dynamic(DHCP) IP	Static IP
Identity Authentication	Account ID/Password, Anonymous, Certificate Verification	Account ID/Password, Anonymous	None
Encryption	SSL/TLS	SSL/TLS	None
Data Transmission	Active (Actively sends Data to the Client)	Active (Actively publishes Data to Broker, and the Broker sends Data to other Clients)	Passive (Wait for Master to poll the Data: Query/Response)
Project Building	Via browse the Server Content	Via subscribe Topic from Broker	Manually assign an ID and define the Data address and type.

3.2.1 Connecting to MQTT Broker

UA I/O module built-in MQTT Client function and itself is the Client side of the connection. So, when setting up the MQTT Broker, it is to set the data of the remote device (Broker) that the UA I/O module wants to connect. The data includes Broker's IP address, port number, anonymous login, account password login, etc.

MQTT Broker Device: recommend to use ICP DAS IIoT communication server **UA-2200/5200/2600 series** or MQTT Broker **BRK-2600M/5200M series**.

Main Menu: 【 MQTT Setting 】 → 【 Connection Setting 】 MQTT Setting → Connection Setting ([Appendix A](#)).

The screenshot shows the 'Connection Setting' web interface. It contains the following fields and a 'Save' button:

- IP Address:** 127.0.0.1
- Port:** 1883
- Anonymous Login:** Enable
- Username:** root
- Password:**
- Save:** Button

Four numbered callouts with red arrows point to specific fields:

1. IP address of the remote MQTT Broker that wants to connect. (MQTT Broker: refer UA-2200/5200 & BRK series of ICP DAS)
2. Port number of the remote MQTT Broker
3. Login username and password of the remote MQTT Broker.
4. Click to save the settings.

If users enable the secure and encrypted MQTT **Certificate Login**, need to upload/download certificates, please refer to [Sec.3.2.3](#).

After completing the MQTT Broker connection settings, then set the **Client connection** (refer to [Sec.3.2.2](#)), and then can communicate with each other.

3.2.2 MQTT Client Setting of the UA I/O

UA I/O built-in MQTT Client function and itself is the MQTT Client side of the connect. When setting, please set the connecting remote MQTT Broker device first, and then set the UA I/O module of the MQTT client.

Reference for MQTT related basic knowledge:

MQTT (MQ Telemetry Transport) is a lightweight **publish/subscribe** messaging protocol. An MQTT-based application will include two or **more clients**, which are applications exchanging messages, and **a broker**, which is a server that accepts incoming messages and routes them to the appropriate destination client. As with most *publish-subscribe* systems, message sends involve **publishing** on a specified **topic**. The **broker** then forwards the message to all **subscribers** of that topic. These primitives can be used to build different interaction patterns. (as the picture below)

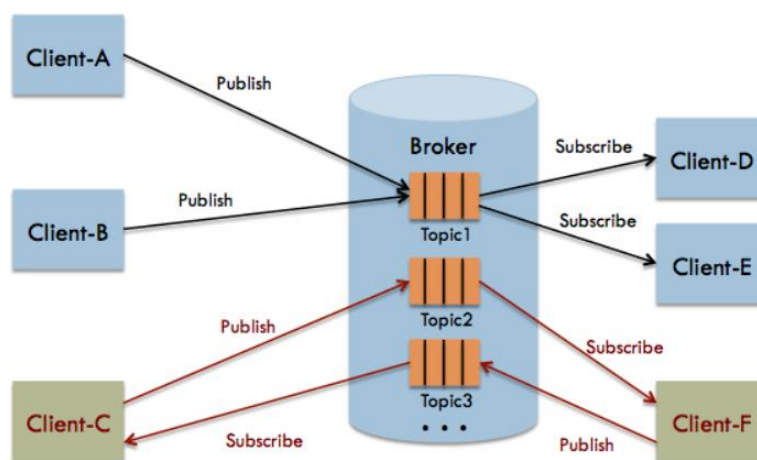

MQTT gives you flexibility by specifying a *Quality of Service* (QoS) with each message. QoS is a parameter available on each publish call. It is one of three levels:

- QoS 0: At most once
- QoS 1: At least once
- QoS 2: Exactly once

Provides a Quality-of-Service data delivery: QoS can be selected based on the needs of the application.

MQTT Retained messages: The last published message (with retained flag set to true) is stored at the broker so that new subscribers can immediately obtain last known good value rather than wait for the next update from publisher.

REFERENCES: (The above information is from the following websites.)

<https://micropython-iot-hackathon.readthedocs.io/en/latest/mqtt.html>

<https://devopedia.org/mqtt>

MQTT Client Setting of the UA I/O:

Manu Path: 【MQTT Setting】 → 【Client Setting】 MQTT Setting → Client Setting (Appendix A).

Content Setting

Scan Rate(ms)	<input type="text" value="1000"/>	1. Set an update frequency for the task data. Default: 1000 (Unit: ms)
Dead Band	<input type="text" value="0"/>	2. Give a dead bend value for updating a float signal.
Will Topic	<input type="text"/>	3. Enter a title of the disconnect notice. 4. Enter a disconnect notice.
Will	<input type="text"/>	
JSON Format	<input checked="" type="checkbox"/> Enable	5. Check “Enable”, the message is sent in groups. Uncheck “Enable”, the message is sent in singly.

Enable of JSON Format: Descriptions for the **Enable (check “Enable”) / Disable (uncheck “Enable”)**

- **Enable:** Enter the **Group setting** screen, the Publish & Subscribe message is sent in a group.
Group setting (JSON Format) the Publish & Subscribe: Suitable for obtaining all I/O values at one time, it can reduce network resources. It will pack all I/O point values into a JSON string, and then send the JSON string as a message or subscribe JSON string to get all I/O values back at one time. (Refer to [Appendix B](#) for the detailed JSON format)
- **Disable:** Enter the **Singly setting** screen, the Publish & Subscribe message is sent in singly (P to P).
Singly setting (Point-to-point) the Publish & Subscribe: Suitable for I/O points that require high real-time performance, or devices that do not support generating or parsing JSON format.

Content Setting

Scan Rate(ms)	<input type="text" value="1000"/>
Dead Band	<input type="text" value="0"/>
Will Topic	<input type="text"/>
Will	<input type="text"/>
JSON Format	<input checked="" type="checkbox"/> Enable

JSON Format Enable

Publish & Subscribe

Details Unfold

Channel	Publish Topic	Publish QoS	Subscribe Topic	Subscribe QoS	Retain
DO0	/U-7526M/DO0/Publish	2	/U-7526M/DO0/Subscribe	2	<input type="checkbox"/>
DO1	/U-7526M/DO1/Publish	2	/U-7526M/DO1/Subscribe	2	<input type="checkbox"/>
DI0	/U-7526M/DI0/Publish	2		2	<input type="checkbox"/>
DI1	/U-7526M/DI1/Publish	2		2	<input type="checkbox"/>
Vout0	/U-7526M/Vout0/Publish	2	/U-7526M/Vout0/Subscribe	2	<input type="checkbox"/>
Vout1	/U-7526M/Vout1/Publish	2	/U-7526M/Vout1/Subscribe	2	<input type="checkbox"/>
Vin0	/U-7526M/Vin0/Publish	2		2	<input type="checkbox"/>
Vin1	/U-7526M/Vin1/Publish	2		2	<input type="checkbox"/>
Vin2	/U-7526M/Vin2/Publish	2		2	<input type="checkbox"/>
Vin3	/U-7526M/Vin3/Publish	2		2	<input type="checkbox"/>
Vin4	/U-7526M/Vin4/Publish	2		2	<input type="checkbox"/>
Vin5	/U-7526M/Vin5/Publish	2		2	<input type="checkbox"/>

Enable (Check) → **Disable (Uncheck)**

Publish & Subscribe

Publish Topic	<input type="text" value="/Name/Publish"/>
Publish QoS	<input type="text" value="2"/>
Subscribe Topic	<input type="text" value="/Name/Subscribe"/>
Subscribe QoS	<input type="text" value="2"/>
Retain	<input type="text" value="False"/>

The setting parameters for Both enable or disable the JSON Format:

MQTT Setting > Client Setting - Publish & Subscribe	
Publish Topic	The topic of sending data / publishing message.
Publish QoS	The publish QoS (Quality of Service) levels. Default: 2 0: Delivering a message at most once. 1: Delivering a message at least once. 2: Delivering a message at exactly once.
Subscribe Topic	The topic of receiving data / subscribing message. It can copy the Publish Topic of linked device.
Subscribe QoS	The subscribe QoS (Quality of Service) levels. Default: 2 0: Delivering a message at most once. 1: Delivering a message at least once. 2: Delivering a message at exactly once.
Retain	Set up if the Broker retains the message.
Save	Click to save the setting of this page.

When **Enable JSON format**, it will pack all I/O point values into a JSON string, and then send the JSON string as a message or subscribe JSON string to get all I/O values back at one time. (Refer to [Appendix B](#))

When **Disable JSON format**, it will publish or subscribe the message in singly (Point-to-point). User needs to set each I/O point.

Channel	Publish Topic	Publish QoS	Subscribe Topic	Subscribe QoS	Retain
DO0	/U-7526M/DO0/Publish	2	/U-7526M/DO0/Subscribe	2	<input type="checkbox"/>
DO1	/U-7526M/DO1/Publish	2	/U-7526M/DO1/Subscribe	2	<input type="checkbox"/>
DI0				2	<input type="checkbox"/>
DI1				2	<input type="checkbox"/>
Vout0				2	<input type="checkbox"/>
Vout1	/U-7526M/Vout1/Publish	2	/U-7526M/Vout1/Subscribe	2	<input type="checkbox"/>

● **Group Setting example: Check “Enable” of “JSON Format”**

Here is an example of the lighting control in a factory. Use the I/O points of the U-7555M module to connect the light switches of Room 1 to 7 in the factory Building-A to monitor/control the on/off of the room lights. We want to use the **Group Setting**, so **check "Enable" of the "JSON Format"**. The following is a parameter example for the settings of [MQTT Setting] > [Client Setting].

Content Setting

Scan Rate(ms)	1000	
Dead Band	0	
Will Topic	/A/1F/U-7555M	
Will	Disconnection	
JSON Format	<input checked="" type="checkbox"/> Enable	

1. Set the update frequency for the task data (1000 ms)

2. Do not set the Dead Band, so keep 0.

3. Set disconnect Topic for 1F of Building-A (U-7555M)
4. Set Will message: Disconnection

5. Check to Enable JSON format to enter the Pub/Sub screen page for Group setting.

The Pub & Sub setting page when enable the JSON Format: Sending/Reading the JSON string

Publish & Subscribe

Publish Topic	/A/1F/U-7555M/Publish	
Publish QoS	2	
Subscribe Topic	/A/1F/U-7555M/Subscribe	
Subscribe QoS	2	
Retain	True	

1. Topic of the publish JSON string: /Build-A/1F/U-7555M/all I/O sending data

2. Set QoS to level 2 for publish. 2: exactly once

3. Topic of the subscribe JSON string: /Build-A/1F/U-7555M/all I/O reading data

4. Set QoS to level 2 for subscribe. 2: exactly once

5. Check to set the Broker retain the message

6. Save all settings of this page.

Note:
 When setting the Pub/Sub of MQTT Client, please also set the Alias of I/O channel, which includes MQTT Alias and OPC UA Description.

MQTT Client setting should cooperate with MQTT Alias of the I/O channels for the accuracy/readability of MQTT communication settings.

Menu: 【Module Setting】 > 【I/O Setting】
 As shown on the right.

Channel	MQTT Alias	OPC UA Description	Power-on Value
DO0	A-1F-Entrance-door	A-1F-Entrance-door_AA	<input type="checkbox"/>
DO1	A-1F-1R-light-1	A-1F-1R-light-1_Aa12	<input type="checkbox"/>
DO2	A-1F-2R-light-2	A-1F-2R-light-2_Aa12	<input type="checkbox"/>
DO3	A-1F-3R-light-3	A-1F-3R-light-3_Aa12	<input type="checkbox"/>
DO4	A-1F-4R-light-4	A-1F-4R-light-4_Aa12	<input type="checkbox"/>
DO5	A-1F-5R-light-5	A-1F-5R-light-5_Aa12	<input type="checkbox"/>
DO6	A-1F-6R-light-6	A-1F-6R-light-6_Aa12	<input type="checkbox"/>
DO7	A-1F-7R-light-7	A-1F-7R-light-7_Aa12	<input type="checkbox"/>

● **Singly Setting example: Uncheck “Enable” of “JSON Format”**

Here is an example of the lighting control in a factory. Use the I/O points of the U-7555M module to connect the light switches of Room 1 to 7 in the factory Building-A to monitor/control the on/off of the room lights. We want to use the **Point-to-Point Setting**, so **uncheck "Enable"** of the "JSON Format". The following is a parameter example for the settings of [MQTT Setting] > [Client Setting].

Content Setting

Scan Rate(ms)	1000	1. Set the update frequency for the task data (1000 ms)
Dead Band	0	2. Do not set the Dead Band, so keep 0.
Will Topic	/A/1F/U-7555M	3. Set disconnect Topic for 1F of Building-A (U-7555M)
Will	Disconnection	4. Set Will message: Disconnection
JSON Format	<input type="checkbox"/> Enable	5. Uncheck to Enable JSON format to enter the Pub/Sub screen page for Group setting.

Publish & Subscribe

IO# Ch.	Channel	1 Publish Topic	2 Publish QoS	3 Subscribe Topic	4 Subscribe QoS	5 Retain
DO0		/A/1F/Entrance-door/Pub	2	/A/1F/Entrance-door//Sub	2	<input checked="" type="checkbox"/>
DO1		/A/1F/light-1/Publish	2	/A/1F/light-1/Subscribe	2	<input checked="" type="checkbox"/>
DO2		/A/1F/light-2/Publish	2	/A/1F/light-2/Subscribe	2	<input checked="" type="checkbox"/>
DO3		/A/1F/light-3/Publish	2	/A/1F/light-3/Subscribe	2	<input checked="" type="checkbox"/>
DO4		/A/1F/light-4/Publish	2	/A/1F/light-4/Subscribe	2	<input checked="" type="checkbox"/>
DO5		/A/1F/light-5/Publish	2	/A/1F/light-5/Subscribe	2	<input checked="" type="checkbox"/>
DO6		/A/1F/light-6/Publish	2	/A/1F/light-6/Subscribe	2	<input checked="" type="checkbox"/>
DO7		/A/1F/light-7/Publish	2	/A/1F/light-7/Subscribe	2	<input checked="" type="checkbox"/>
IN0		/U-7555M/IN0/Publish	2		2	<input checked="" type="checkbox"/>
IN1		/U-7555M/IN1/Publish	2		2	<input checked="" type="checkbox"/>
IN2		/U-7555M/IN2/Publish	2		2	<input checked="" type="checkbox"/>
IN3		/U-7555M/IN3/Publish	2		2	<input checked="" type="checkbox"/>
IN4		/U-7555M/IN4/Publish	2		2	<input checked="" type="checkbox"/>
IN5		/U-7555M/IN5/Publish	2		2	<input checked="" type="checkbox"/>
IN6		/U-7555M/IN6/Publish	2		2	<input checked="" type="checkbox"/>
IN7		/U-7555M/IN7/Publish	2		2	<input checked="" type="checkbox"/>

Save

6. Save all settings.

Uncheck the JSON Format to do the Point-to-Point singly setting (as the left figure): User needs to set up each Topic/QoS of Publish/Subscribe for each I/O channel.

1. Set the Publish Topic of DO0 and set each IO#. Topic means: /Building-A/1F/light# of U-7555M/Topic
2. The level of sending Topic for each IO#. level 2: Exactly once
3. Set the Subscribe Topic of DO0 and set each IO#. Topic means: /Building-A/1F/light# of U-7555M/Topic
4. The level of reading Topic for each IO#. level 2: Exactly once
5. Check to set the Broker retain the message

3.2.3 Secure Encrypted Connection: MQTT Certificate

When using the MQTT connection, in addition to the account login for security, users can also enable the SSL/TLS login to use the MQTT Certificate protection of the secure encryption. This section describes how to download/upload the certificates. If you do not want to enable the certificate login, please skip.

The settings of MQTT certificate connection need to enable the SSL/TLS secure encryption. And the UA I/O needs to get the certificate of the connecting device first. And then upload the certificates to UA I/O. There are three types of certificates: Trusted Certificate, Certificate, and Private Key.

Please upload the files to the UA I/O module according to the type of certificates:

To perform the One-way authentication, you need to upload the Trusted Certificate.

To perform the Two-way authentication, you need to upload the Trusted Certificate first, and then upload the Certificate and Private Key.

Note:

1. **One-way authentication:** The Client verifies the validity of Broker credentials; need to upload the Trusted Certificate.
2. **Two-way authentication:** The Client and Broker verify the validity of the certificate with each other; need to upload the Trusted Certificate first, and then upload the Certificate and Private Key.
3. **Trusted Certificate:** File format must be **PEM**. Extension name must be “pem”, “cer”, or “crt”.
4. **Certificate:** File format must be **PEM**. Extension name must be “pem”, “cer”, or “crt”.
5. **Private Key:** File format must be **PEM**. Extension name must be “key”.

Manu Path: 【MQTT Setting】 → 【Client Setting】 MQTT Setting → Client Setting (Appendix A).

Content Setting

SSL/TLS Enable

Save

Upload the file to the device

Authentication Two-way Authentication

Trusted Certificate	Upload
Certificate	Upload
Private Key	Upload

3.3 Rule Setting

本節說明 UA I/O 的邏輯控制功能“規則設定”如何設定，提供簡易的邏輯判斷規則腳本，讓 UA I/O 做自動判斷和控制，達到簡易的智能化。

Manu Path:

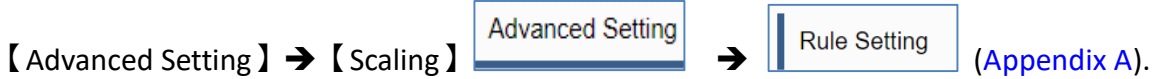

● **Setting Steps:**

First, click [Advanced Setting] > [Rule Setting], switch to the rule setting screen, to add the condition.

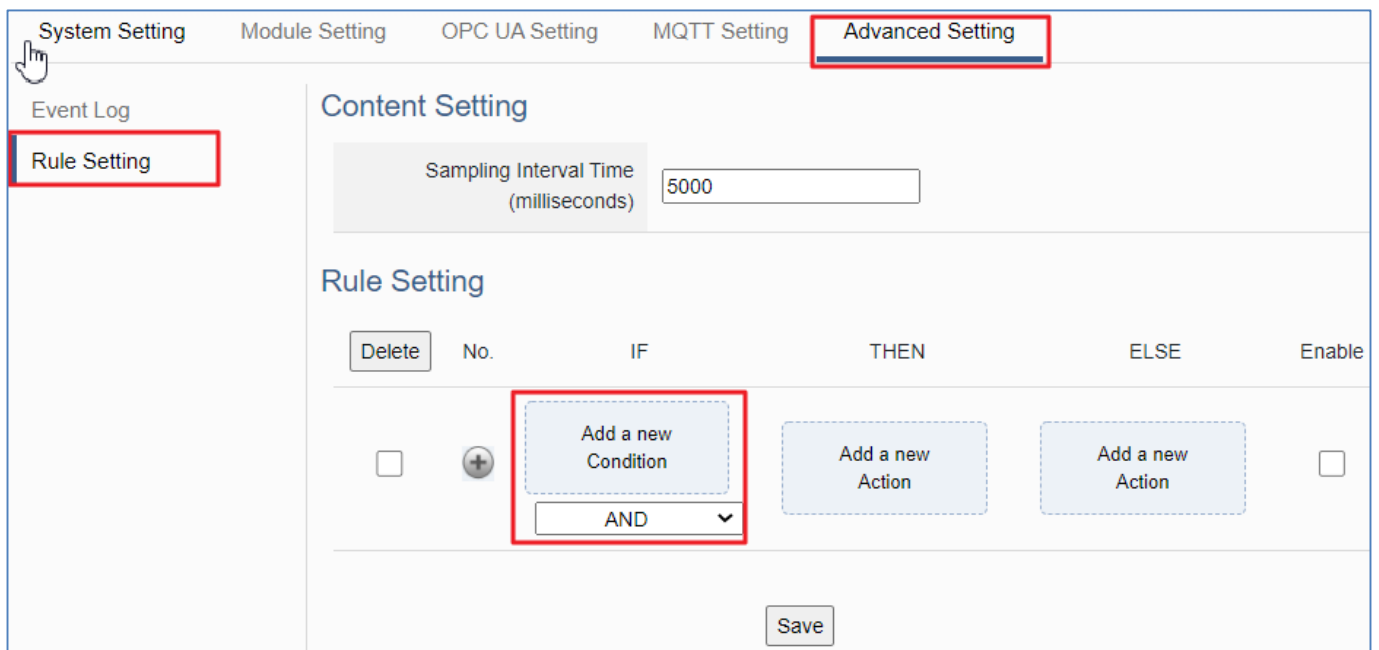

Select an I/O point, to add a condition rule.

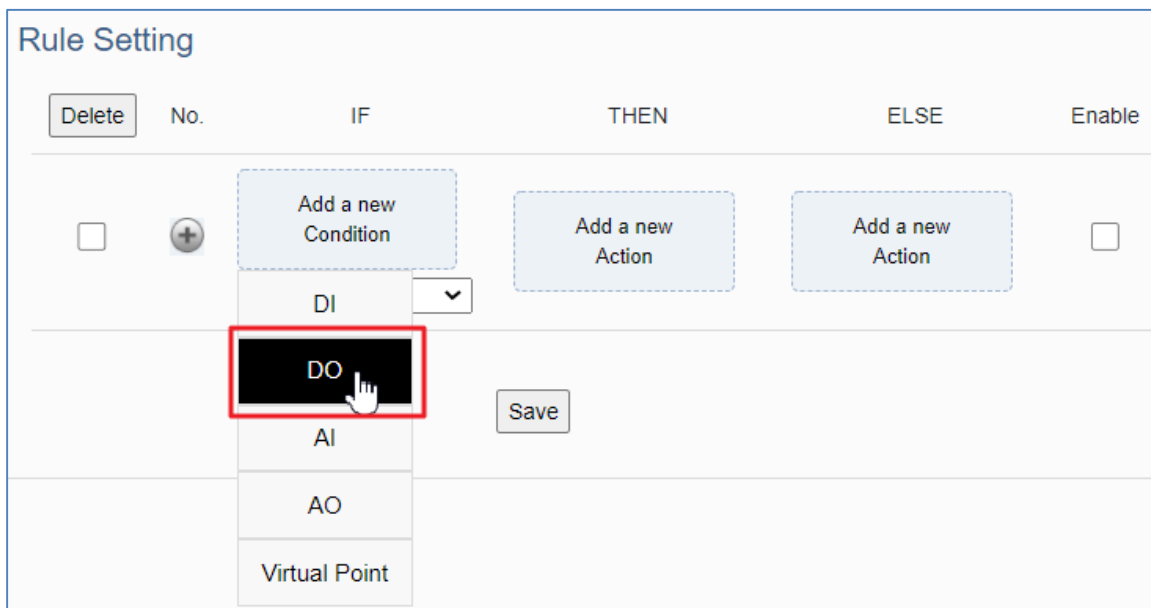

DO Condition Setting

Channel(Alias)	RL0 ▼
Status	ON ▼

Select an I/O point, to add a condition rule.

Rule Setting

<input type="button" value="Delete"/>	No.	IF	THEN	ELSE	Enable
<input type="checkbox"/>	+	Add a new Condition	Add a new Action	Add a new Action	<input type="checkbox"/>
		DI ▼ DO AI AO Virtual Point	<input type="button" value="Save"/>		

Virtual Point Condition Setting

Alias	Operator	Value
VirtualTag0 ▼	>= ▼	36

Rule Setting

<input type="button" value="Delete"/>	No.	IF	THEN	ELSE	Enable
<input type="checkbox"/>	+	Add a new Condition	Add a new Action	Add a new Action	<input type="checkbox"/>
		AND ▼ RL0 = ON 🗑 VirtualTag0 >= 36 🗑	<input type="button" value="Save"/>		

Click the “Delete” icon indicated by the green arrow to delete the rule condition.

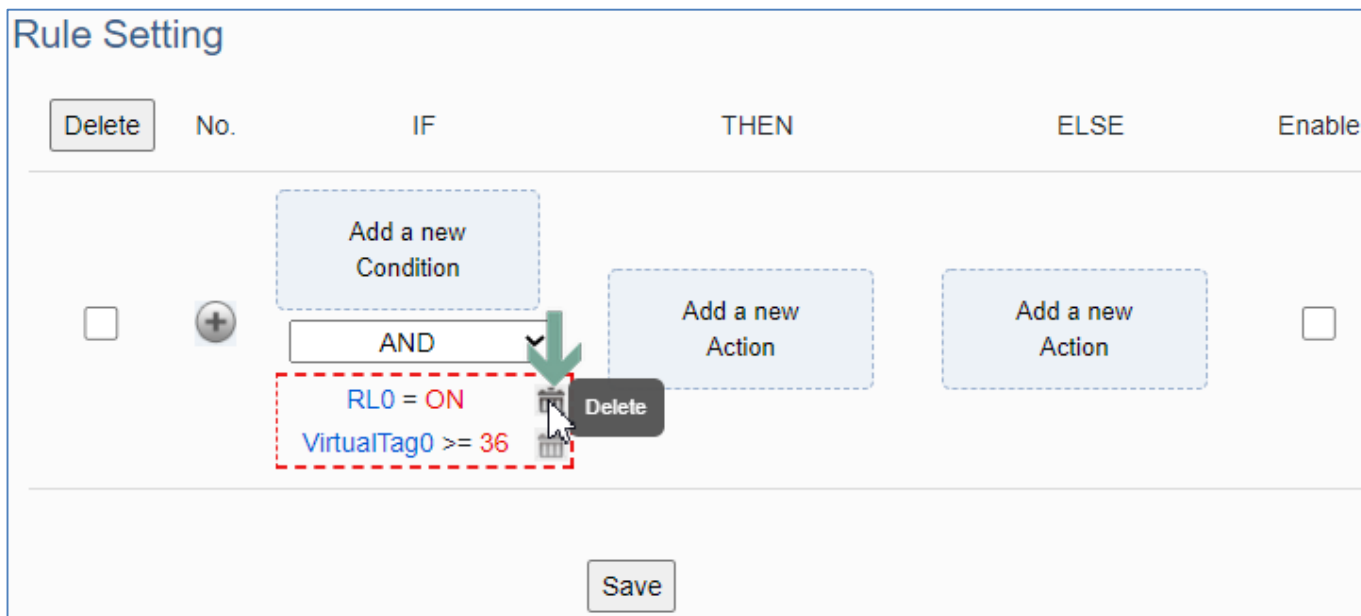

Set up the “IF, THEN, ELSE” conditions/actions to add the rule according to the above steps.

Then, click the "+" icon on the left to add the rule to the table.

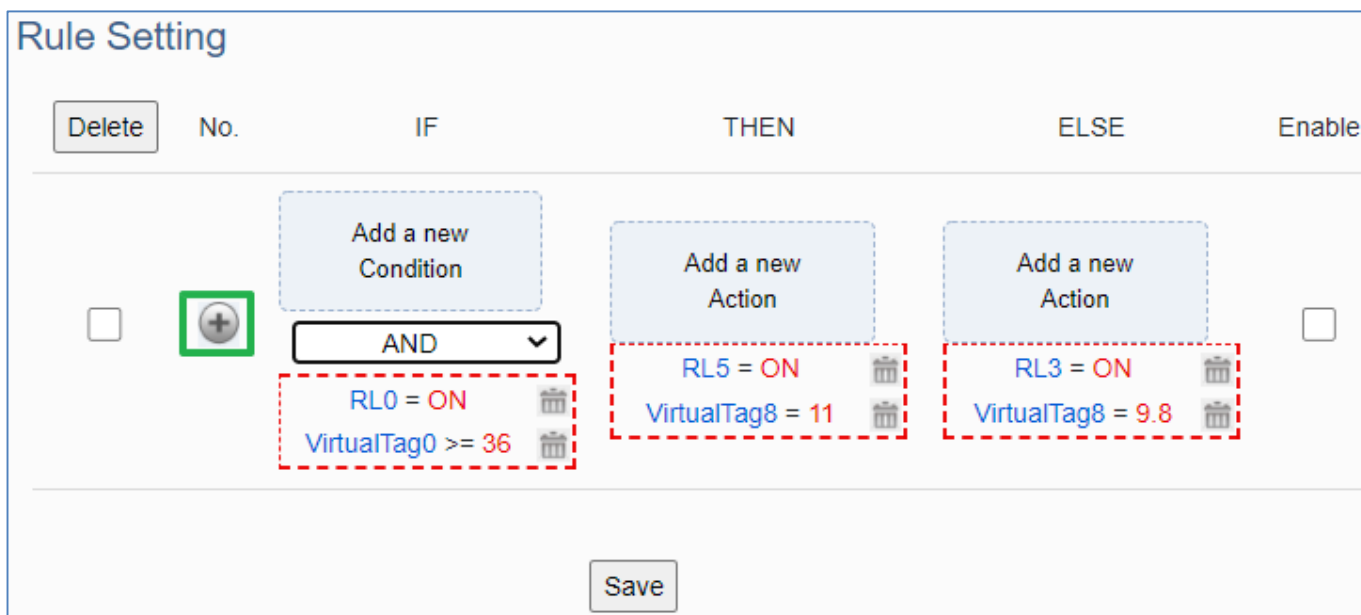

Red box part: AND or OR means that all judgment conditions are AND or OR.

Example: Condition 1 AND Condition 2 AND Condition 3...

Example: Condition 1 OR Condition 2 OR Condition 3...

Rule Setting

Delete	No.	IF	THEN	ELSE	Enable
<input type="checkbox"/>	<input style="border: 1px dashed gray;" type="button" value="+"/>	<div style="border: 1px dashed gray; padding: 5px; text-align: center;">Add a new Condition</div> <div style="border: 1px solid gray; padding: 2px; text-align: center;">AND</div>	<div style="border: 1px dashed gray; padding: 5px; text-align: center;">Add a new Action</div>	<div style="border: 1px dashed gray; padding: 5px; text-align: center;">Add a new Action</div>	<input type="checkbox"/>
<input type="checkbox"/>	1	<div style="border: 2px solid red; padding: 5px;"> AND RL0 = ON VirtualTag0 >= 36 </div>	RL5 = ON VirtualTag8 = 11	RL3 = ON VirtualTag8 = 9.8	<input checked="" type="checkbox"/>

Changing the sampling interval time to speed up the rule judgment. Click “Save” to write the settings of this page to the device.

Content Setting

Sampling Interval Time (milliseconds)

Rule Setting

Delete	No.	IF	THEN	ELSE	Enable
<input type="checkbox"/>	<input style="border: 1px dashed gray;" type="button" value="+"/>	<div style="border: 1px dashed gray; padding: 5px; text-align: center;">Add a new Condition</div> <div style="border: 1px solid gray; padding: 2px; text-align: center;">AND</div>	<div style="border: 1px dashed gray; padding: 5px; text-align: center;">Add a new Action</div>	<div style="border: 1px dashed gray; padding: 5px; text-align: center;">Add a new Action</div>	<input type="checkbox"/>
<input type="checkbox"/>	1	AND RL0 = ON VirtualTag0 >= 36	RL5 = ON VirtualTag8 = 11	RL3 = ON VirtualTag8 = 9.8	<input checked="" type="checkbox"/>

Save

 Success

3.4 RESTful API: Read and Write I/O and Virtual Point

This section describes RESTful API functions and usage. UA I/O supports RESTful API functions. Users can remotely read and write the I/O points (include the virtual point) of UA I/O modules through HTTP.

- **What is Restful API?**

REST (Representational state transfer) is a software architectural style that was created to guide the design and development of the architecture for the World Wide Web. REST is a widely accepted set of guidelines for creating stateless, reliable web APIs. A web API that obeys the REST constraints is informally described as **RESTful**. **RESTful** web APIs are typically loosely based on HTTP methods to access resources via URL-encoded parameters and transmit data.

- **Use RESTful with UA I/O**

Reading and writing the virtual points are the same as that of physical I/O points. Examples:

[Example 1.]

IP/AllVariableName : Define 10 virtual points (all types are AO), and the names all start with VirtualTag (red box in the figure below).

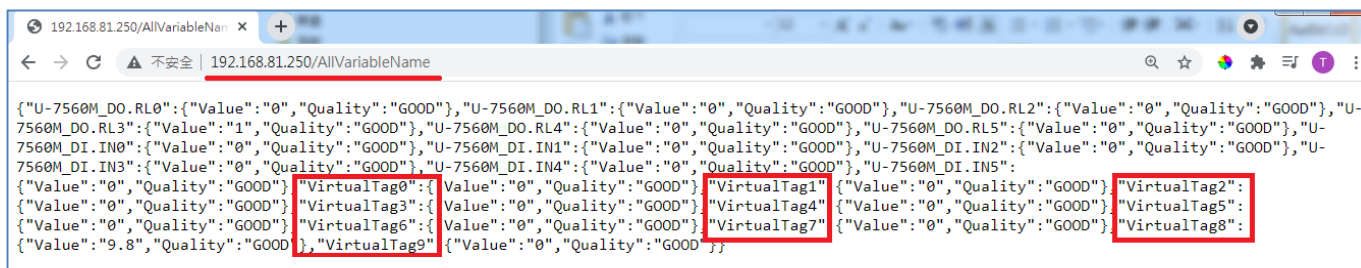

Or as following:

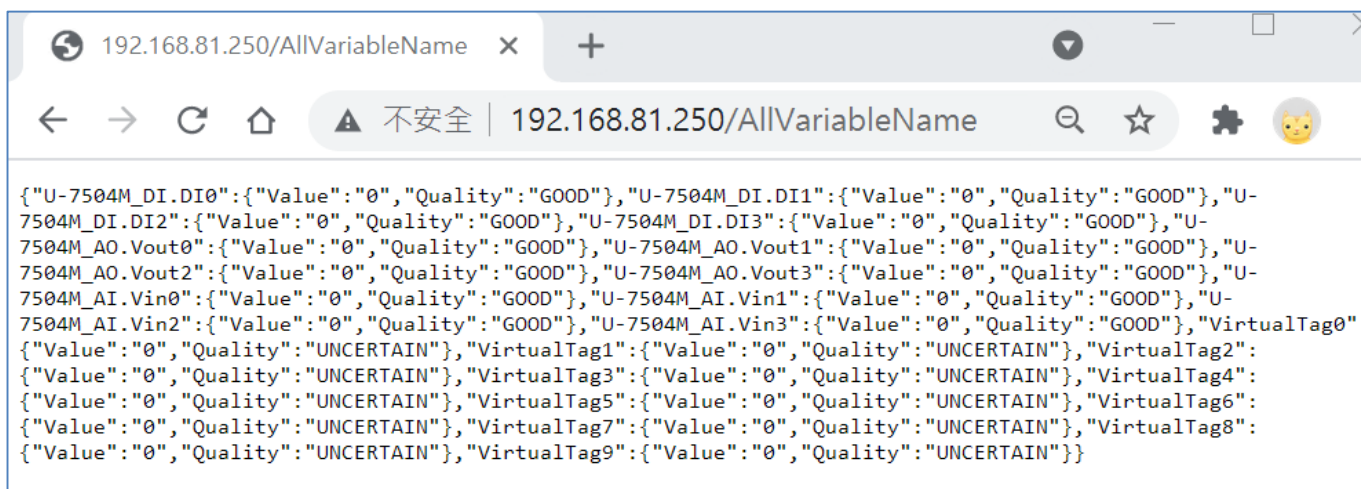

[Example 2.]

IP/VariableInformation?VirtualTag0 : RESTful **Read** the value of VirtualTag0

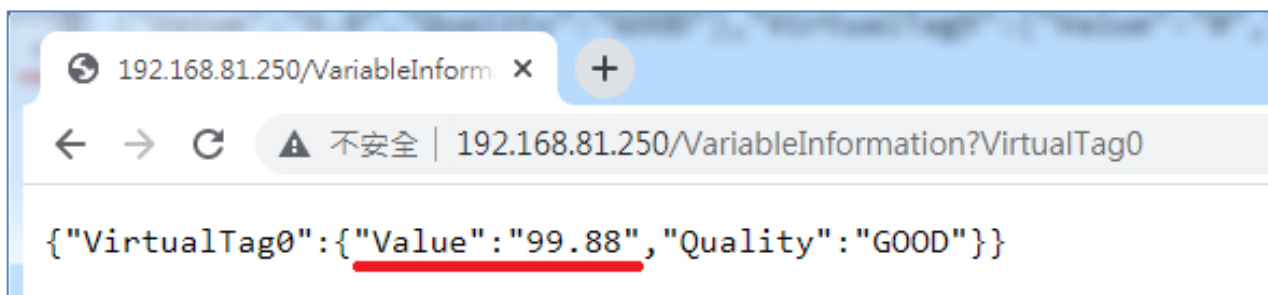

Or as following:

IP/VariableInformation?U-7504M_DI.DI0 : RESTful **Read** the DI.DI0 value of U-7504M.

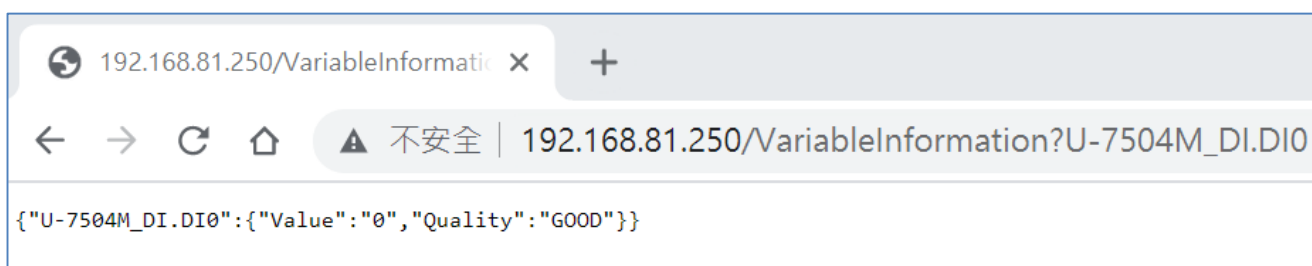

[Example 3.]

IP/VariableInformation : RESTful **write** the value of VirtualTag0

This example uses the Firefox as the RESTful client.

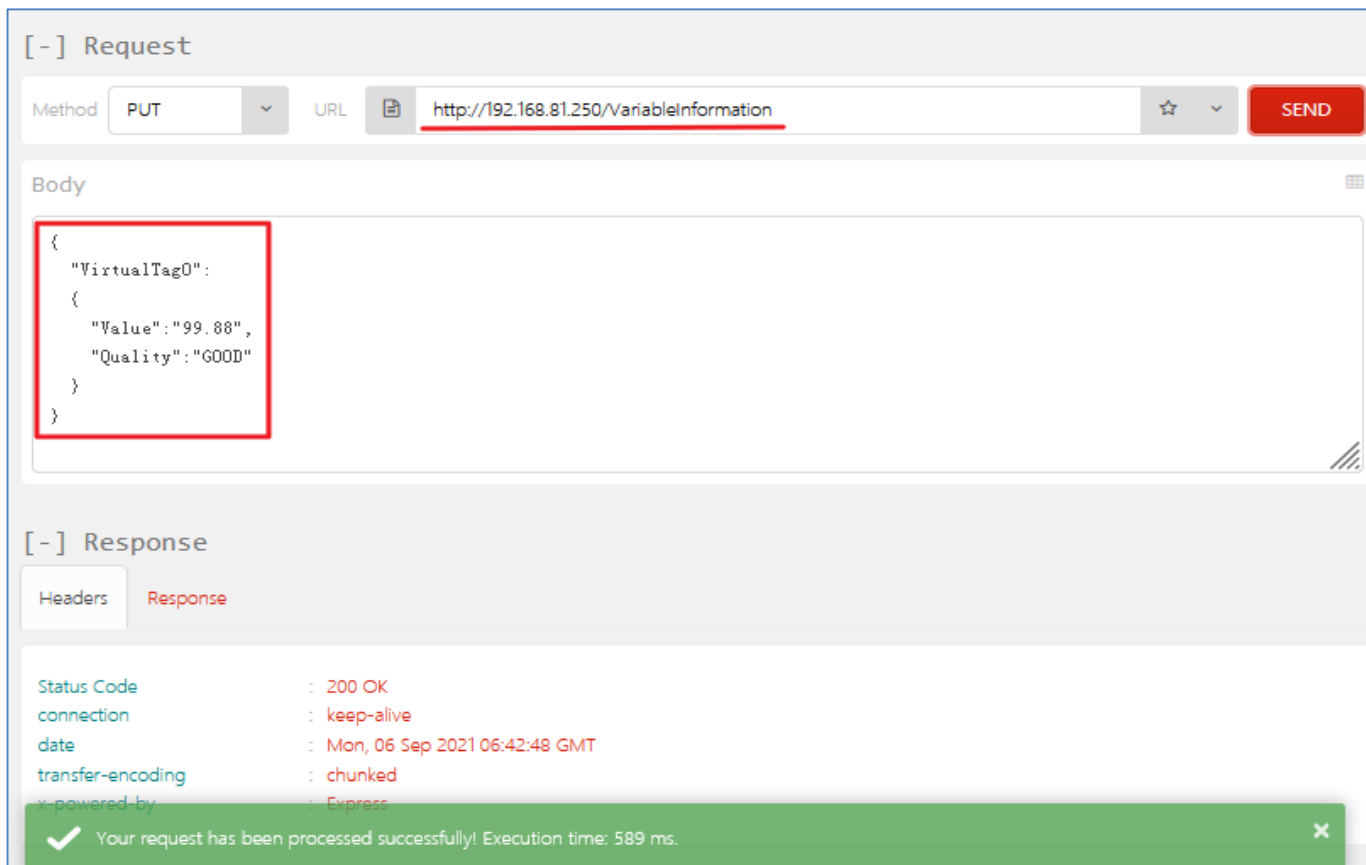

● **RESTful Description**

[Resource Definition]

HTTP Method	Path	Description	Remarks
GET	/AllVariableName	Read all variable data.	Link to Example G1.1
	/VariableInformation?var0, var1, var2...	Read the data of var0, var1, var2... in all variables, data are separated by commas.	Link to Example G1.2
PUT	/VariableInformation	writes the variable data being used.	Link to Example P1.1

[JSON Description]

JSON Content	Item	Description
<pre>{ "Var1": { "Quality": "Good", "Value": "24.5" }, "Var2": { "Quality": "Good", "Value": "24.5" } }</pre>	Quality	The communication quality of the variable. Return Item: Good, Uncertain, Bad.
	Value	Return the value of the variable.

[GET Examples]

Resource Definition	Actual Application Corresponding to the Resource Definition
GET /AllVariableName	GET /AllVariableName
Description Back to G1.1	
<p>GET : Read</p> <p>/AllVariableName : All variables</p> <p>For Example :</p> <p>GET /AllVariableName : Read all variable data, and the return value is in JSON format.</p>	
Resource Definition	Actual Application Corresponding to the Resource Definition
GET /VariableInformation?var0, var1, var2...	GET /VariableInformation?U-7560M_DO.RL0,U-7560M_DO.RL1
Description Back to G1.2	
<p>GET : Read</p> <p>/VariableInformation : Variable Information.</p> <p>? : Used to separate the API and the parameters.</p> <p>U-7560M_DO.RL0 : The variable name of the module.</p> <p>U-7560M_DO.RL1 : The variable name of the module.</p> <p>Use "commas" to separate variables.</p> <p>For Example :</p> <p>GET /VariableInformation?U-7560M_DO.RL0, U-7560M_DO.RL1</p> <p>The data of variables such as U-7560M_DO.RL0, U-7560M_DO.RL1. The return value is in JSON format.</p>	

[PUT Example]

Resource Definition	Actual Application Corresponding to the Resource Definition
PUT /VariableInformation	PUT /var/use [RAW Body] <pre> { "Var1": { "Quality": "Good", "Value": "24.5" }, "Var2": { "Quality": "Good", "Value": "24.5" } } </pre>
Description	Back to P1.1
<p>PUT : Write</p> <p>/VariableInformation : Variable Information.</p> <p>[RAW Body] : The JSON format to be written.</p> <p>PUT /VariableInformation : Compare from [RAW Body], check whether the variable name exists on the server side, modify it if it exists, and skip it if it doesn't. The return value is a string.</p>	

4. Main Menu: Parameter Descriptions

This chapter introduces the menu functions of the UA I/O web UI and more focused on the function parameters of the menu. Each section introduces one main menu and its sub-menu functions. The function location is showing in a brief text and diagram of **【Menu Path】**, for Menu Path introductions please refer to [Appendix A](#).

4.1 Main Menu - System Setting

System Setting is the first item of the Main Menu. This item is about the settings related to the hardware and operating system.

4.1.1 Overview

Function: Display the current information of the hardware and operating system.

Support Module: All UA I/O modules support this function.

Manu Path: **【System Setting】** → **【Overview】** System Setting → Overview (Refer to [Appendix A](#)).

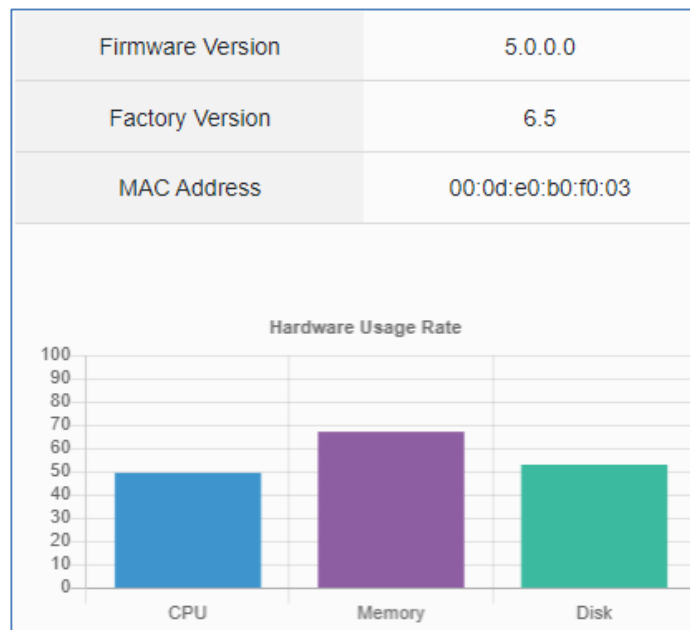

System Setting > Overview	
Firmware Version	Display the firmware version of the UA I/O module.
Factory Version	Display the factory version (OS & UI) of the UA I/O module.
MAC Address	The LAN MAC address of this UA I/O.
CPU	Display the current CPU usage of the module. Do not use to achieve 95% or more.
Memory	Display the current memory usage of the module. Do not use to achieve 95% or more.
Disk	Display the current disk usage of the module. Do not use to achieve 95% or more.

4.1.2 Network Setting

Function: Display and set up the network settings of the UA I/O.

Support Module: All UA I/O modules support this function.

Manu Path: 【System Setting】 → 【Network Setting】 System Setting → Network Setting (Appendix A).

- **Network Setting (LAN)**

Network Setting (LAN)

Connection Mode	<input checked="" type="radio"/> Specify an IP address. <input type="radio"/> Obtain an IP address automatically.(DHCP)
IP Address	<input style="width: 40px;" type="text" value="192"/> · <input style="width: 40px;" type="text" value="168"/> · <input style="width: 40px;" type="text" value="81"/> · <input style="width: 40px;" type="text" value="252"/>
Mask	<input style="width: 40px;" type="text" value="255"/> · <input style="width: 40px;" type="text" value="255"/> · <input style="width: 40px;" type="text" value="0"/> · <input style="width: 40px;" type="text" value="0"/>
Gateway	<input style="width: 40px;" type="text" value="192"/> · <input style="width: 40px;" type="text" value="168"/> · <input style="width: 40px;" type="text" value="1"/> · <input style="width: 40px;" type="text" value="1"/>
MAC Address	00:00:00:00:81:52

System Setting > Network Setting - Network Setting (LAN)	
Connection Mode	Specify an IP address: Users input the values in the fields of IP, Mask and Gateway according to customer's network. Detail information for the factory default value of UA controller network refers to the. Sec. 4.1.7 Obtain an IP address automatically (DHCP): It's the Dynamic Host Configuration Protocol mode. The system assigns the IP, Mask and Gateway automatically.
IP Address	The LAN IP address of this UA I/O. Factory Default: 192.168.255.1
Mask	The LAN mask address of this UA I/O. Factory Default: 255.255.0.0
Gateway	The LAN gateway address of this UA I/O. Factory Default: 192.168.1.1
MAC Address	The LAN MAC address of this UA I/O.
Save	Click to save the settings of LAN item.

● **Hostname Setting**

Hostname Setting

Hostname

System Setting > Network Setting - Hostname Setting	
Hostname	The host name of this UA I/O. Default: system value. User can give a new name, but cannot be null, Chinese characters, or special symbols.
Save	Click to save the settings of this item.

4.1.3 Time Setting

Function: Display and set up the date and time of the UA I/O.

Support Module: All UA I/O modules support this function.

Manu Path: 【System Setting】 → 【Time Setting】 System Setting → Time Setting (Appendix A).

- **Date and Time Display**

Date And Time Display

	Date	2020 / 6 / 8
	Time	14 : 45 : 3

System Setting > Time Setting - Date And Time Display	
Date	Display the date of the UA I/O module, including year, month and day.
Time	Display the current time of the UA I/O module, including hour, minute and second.

When the device time is one day different from the local computer time, a warning message "[Please check the time](#)" will be displayed, as shown in the below.

System Setting
Module Setting
OPC UA Setting
MQTT Setting
Advanced Setting

- Overview
- Network Setting
- Time Setting
- Please check the time
- Account Setting
- Web Server Setting
- Firewall Setting
- Firmware Setting

Date And Time Display

	Date	2021 / 9 / 1
	Time	15 : 8 : 19

NTP time calibration
Set the time manually

Functional Status	<input checked="" type="radio"/> NTP Server <input type="radio"/> Custom Time Server
NTP Server	<input type="text" value="time1.google.com"/>
Time Zone	<input type="text" value="Taipei"/>

Success

● **NTP time calibration**

System Setting > Time Setting - NTP time calibration

Functional Status	NTP Server: Click to display the setting columns for NTP Server. Custom Time Server: Click to display the setting columns for Custom Time Server.
NTP Server	Select the common time server provided by the system.
Custom Time Server	Enter the IP address of the time server by custom.
Time Zone	Select the time zone of your location.
Save	Click to save the settings of this item and update the data of “Time Setting” to the “Date And Time Display” on the top of this page.

● **Set the time manually**

System Setting > Time Setting - Set The Time Manually

Date	Set the system date of the UA I/O by manually. Directly enter the new year/month/day, and then click “Save”.
Time	Set the system time of the UA I/O by manually. Directly enter the new hour : minute : second, and then click “Save”.
Read The Local Computer Time	Click [Read] can copy the current time of the using computer to the “Time Setting” of this item.
Time Zone	Select the time zone of your location.
Save	Click to save the settings of this item and update the data of “Time Setting” to the “Date And Time Display” on the top of this page.

4.1.4 Account Setting

Function: Display and set up the login username and password of the UA I/O Web UI.

Support Module: All UA I/O modules support this function.

Manu Path: 【System Setting】 → 【Account Setting】  →  (Appendix A).

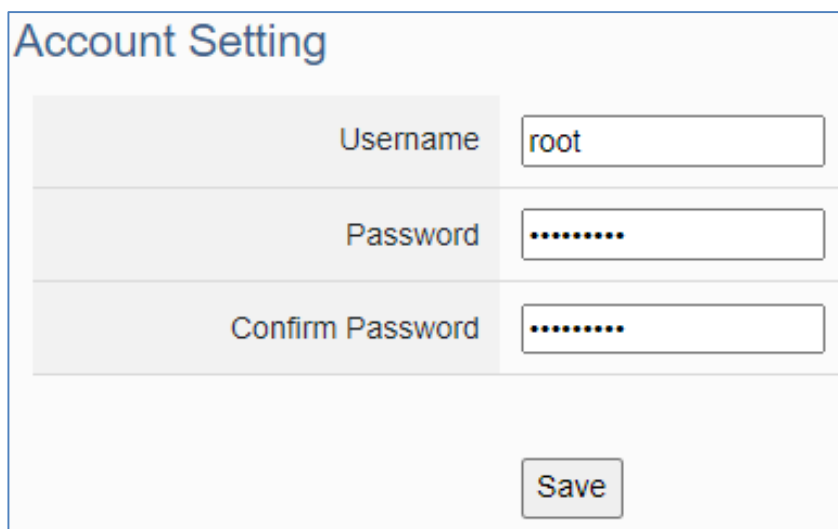

System Setting > Account Setting			
Username	The login username for the UA Web UI. Factory default: root. Cannot be null. After the first login in using the factory default settings, change the default username/password first, or user cannot use any other function (design for data security) except the [Overview] and [Account Setting] (Mouse showing hand shape).		
Password	The login password for the UA Web UI. Factory default: root. Cannot be null. After the first login in using the factory default settings, change the default username/password first, or user cannot use any other function (design for data security) except the [Overview] and [Account Setting] (Mouse showing hand shape). Password setting rules: <table border="1" data-bbox="370 1523 1212 1769"> <tr> <td>Password</td> <td> <ol style="list-style-type: none"> 1. Must not be the same as the account. 2. The length must be greater than 6 characters. 3. With English uppercase. 4. With English lowercase. 5. With numbers. </td> </tr> </table>	Password	<ol style="list-style-type: none"> 1. Must not be the same as the account. 2. The length must be greater than 6 characters. 3. With English uppercase. 4. With English lowercase. 5. With numbers.
Password	<ol style="list-style-type: none"> 1. Must not be the same as the account. 2. The length must be greater than 6 characters. 3. With English uppercase. 4. With English lowercase. 5. With numbers. 		
Confirm Password	Retype the password for the operation conform when setting the new account information.		
Save	Click to save the settings of this page.		

4.1.5 Web Server Setting

Function: Provide Web Server settings, such as display and set the Web Server port.

Support Module: All UA I/O modules support this function.

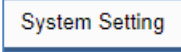
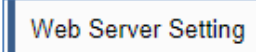
Manu Path:【 System Setting 】→【 Web Server Setting 】  →  (Appendix A).

- **Http Web Server Setting**

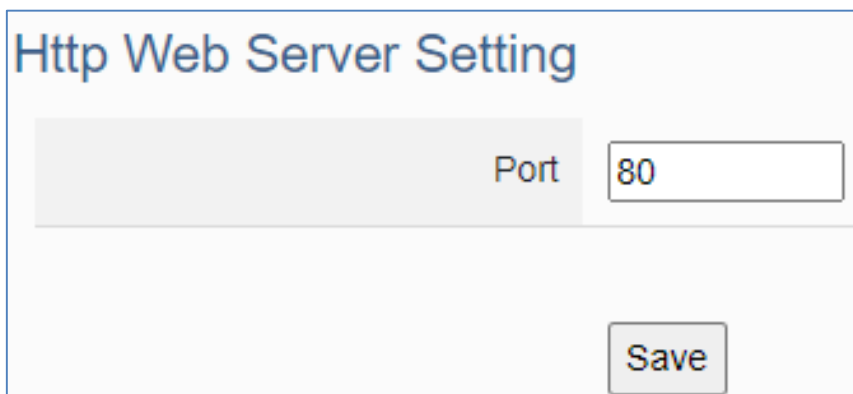

System Setting > Http Web Server Setting	
Port	Web Server port of the UA I/O device. Factory default port: 80.
Save	Click to save the settings.

● **Https Web Server Setting**

Https Web Server Setting

Port	<input type="text" value="8888"/>
Certificate File : server.crt	<input type="button" value="Upload"/>
Private Key File : server.key	<input type="button" value="Upload"/>
<input type="button" value="Save"/>	

System Setting > Https Web Server Setting	
Port	Https Web Server port of the UA I/O device. Factory default port: 8888.
Certificate	The server certificate required for HTTPS communication. File name rule: [A-Z, a-z, 0-9].crt, only .crt files composed of English uppercase and lowercase and numbers are accepted.
Private Key	Server private key required for HTTPS communication. File name rule: [A-Z, a-z, 0-9].key, only .key files composed of English uppercase and lowercase and numbers are accepted.
Save	Click to save the settings.

NOTE: After click “save” icon, system will restart the Web Server. It takes time to start, please wait patiently.

4.1.6 Firewall Setting

Function: Provide firewall settings, allowing specific IP to have permission to connect to the module.

Support Module: All UA I/O modules support this function.

Manu Path: 【System Setting】 → 【Firewall Setting】 System Setting → Firewall Setting ([Appendix A](#)).

Allow Remote Device Connection

Allow All IP	<input type="checkbox"/> Enable
Allow IP	<input type="text"/>
Allow IP	<input type="text"/>
Allow IP	<input type="text"/>

System Setting > Firewall Setting	
Allow all IP	Check box to allow all IPs to connect to UA-I/O. Factory default value: Enabled.
Allow IP	Enter the IP to allow specific IP to connect to UA-I/O. Limit the number of IP connections: 3 at most.
Save	Click to save the settings of this page.

4.1.7 Firmware Setting

Function: Provide firmware settings, such as restore factory setting and update firmware.

Support Module: All UA I/O modules support this function.

Manu Path: 【System Setting】 → 【Firmware Setting】 System Setting → Firmware Setting (Appendix A).

- **Restore Factory Setting**

1. Check the “Enable” box to enable the “Restore” button, and then click on the “Restore” button to start the restore operation.

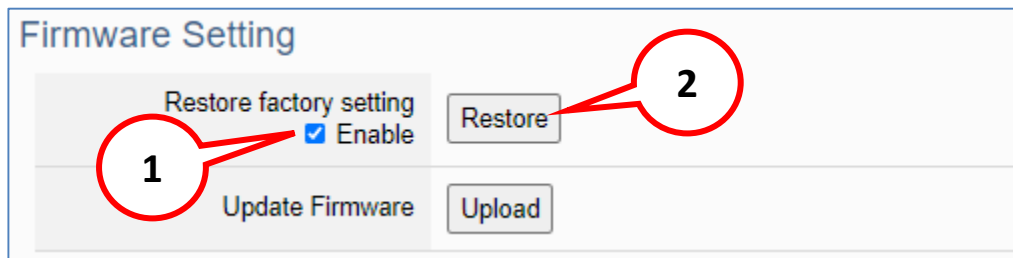

2. A message will prompt appear, showing the installation process of the restore program, please wait approximately 2 minutes.

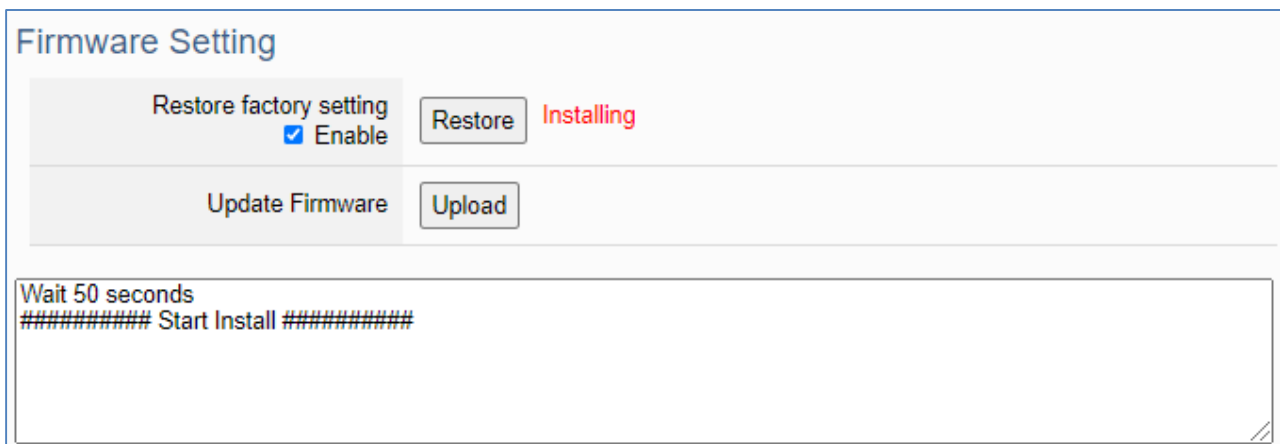

- After the process finished, it appears a box message "During device restart, after waiting for 60 seconds, press OK", indicating that **this restoration succeeds**. If the box does not pop up, **this restoration fails**.

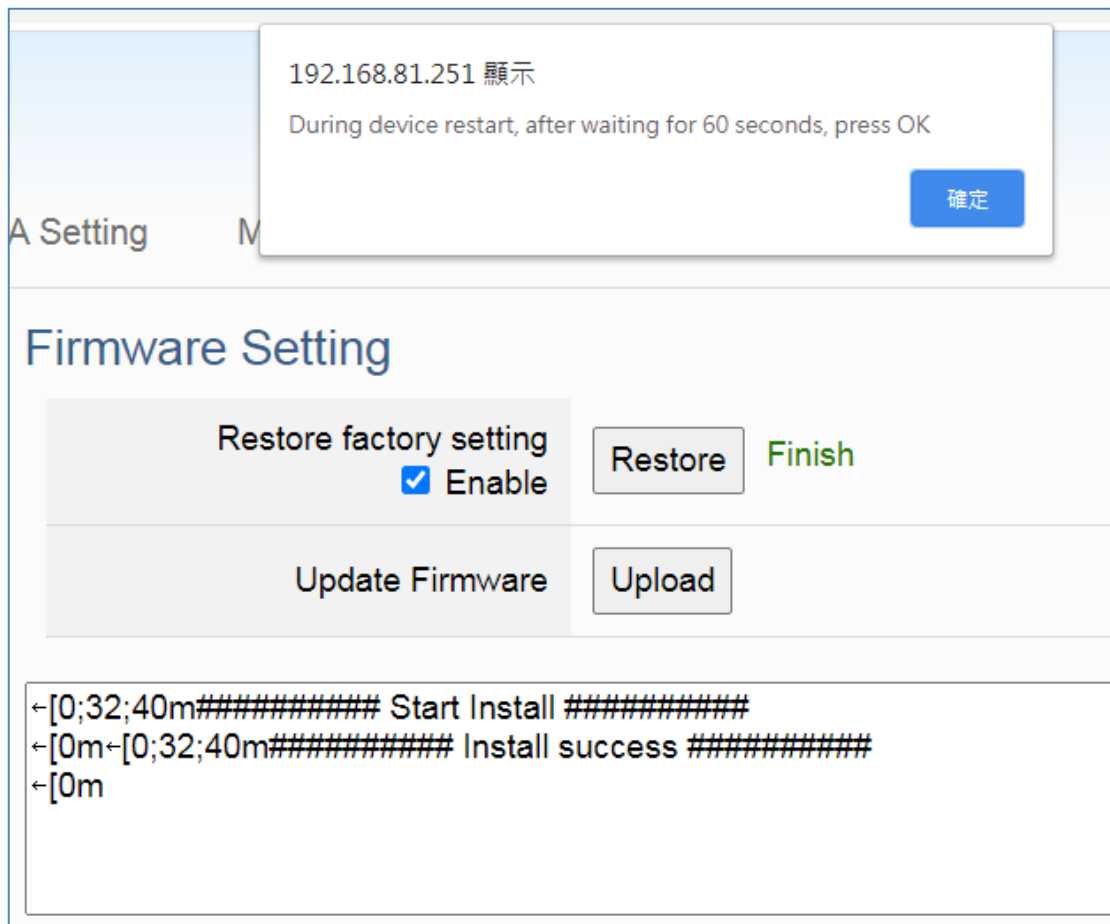

- After restarting, the module will restore the factory default settings as follows: (Web IP address automatically changes to 192.168.255.1)

Factory Default Settings of UA I/O Modules			
Network	IP (LAN)	192.168.255.1	Assign UA I/O a new IP setting according to your case.
	Netmask	255.255.0.0	
	Gateway	192.168.1.1	
Web UI Account	Username	root	After login, change the default username/password to use other functions.
	Password	root	

● **Update Firmware**

When UA I/O has new functions, users can go to the UA series download center on the ICP DAS website to download the latest version of Firmware software, and then update the firmware of your UA I/O module according to the steps in this section.

UA series download center on the ICP DAS website:

<https://www.icpdas.com/en/download/index.php?nation=US&kind1=&model=&kw=ua->

1. Click on the “Upload” button

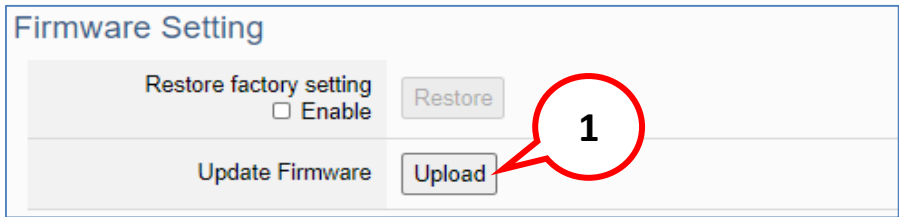

2. Select the firmware file

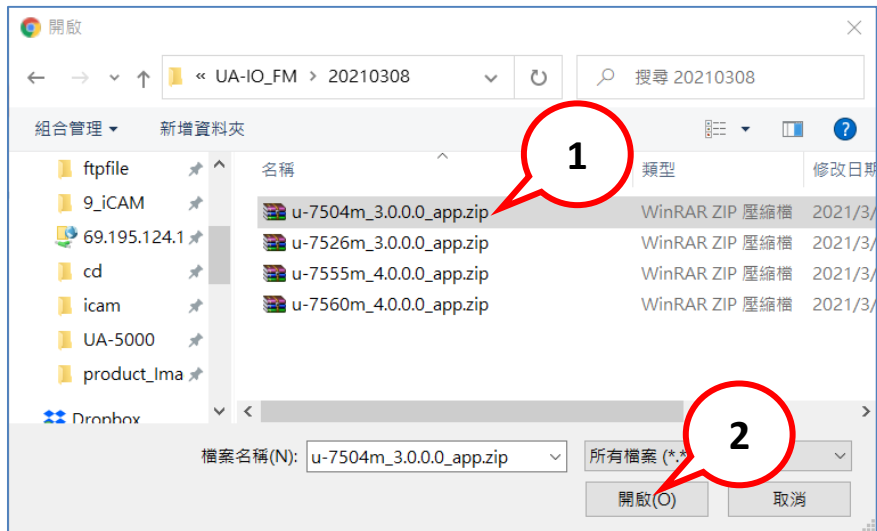

3. Begin to upload the Firmware file, and the lower message box will show the progress.

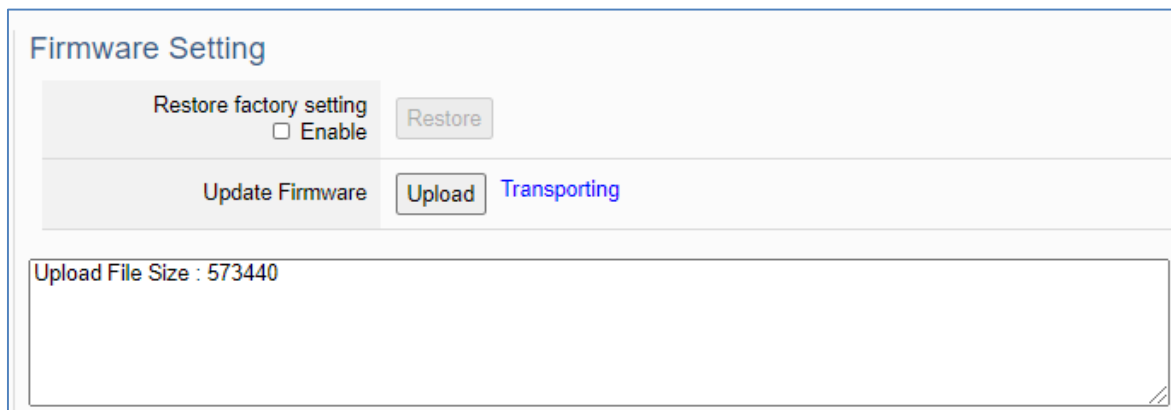

4. After upload the file, it begins to install the firmware.

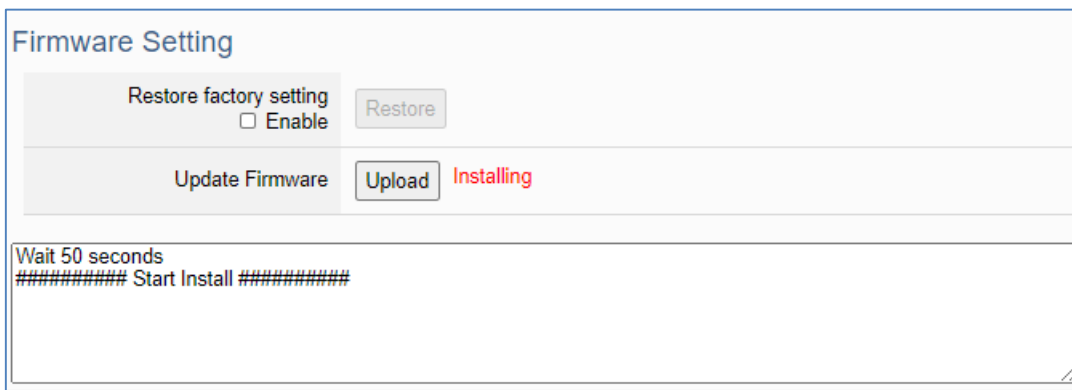

5. After the process finished, it appears a box message "During device restart, after waiting for 60 seconds, press OK", indicating that **this update succeeds**. If the box does not pop up, **this update fails**.

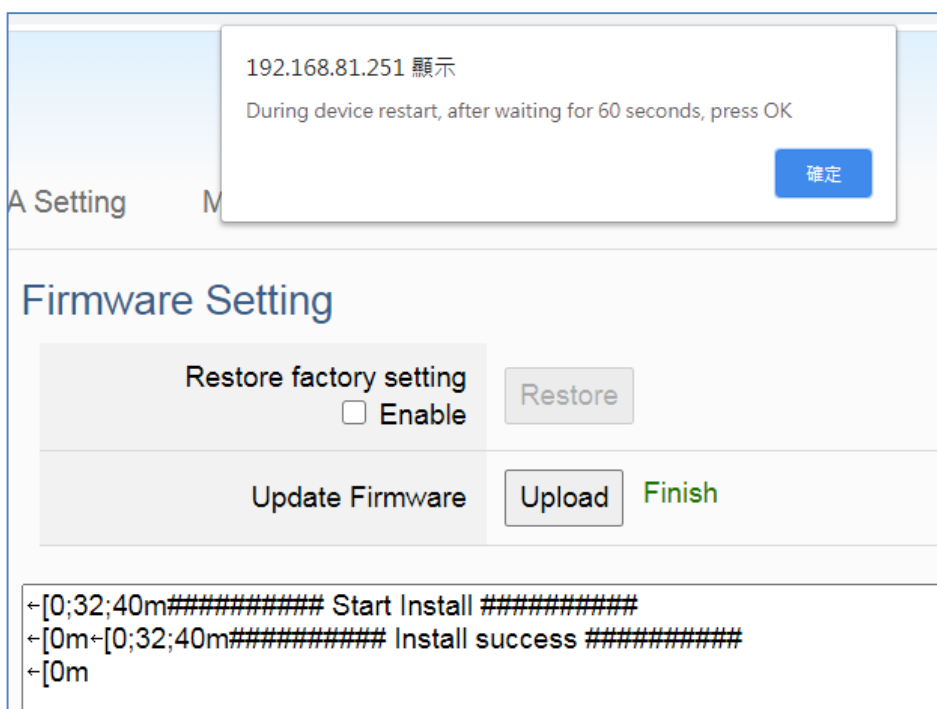

6. After restarting, the module will recover the UA I/O settings as follows:

Update Firmware of UA I/O Modules			
Network	IP (LAN)	Keep the original setting	Assign UA I/O a new IP setting according to your case.
	Netmask	Keep the original setting	
	Gateway	Keep the original setting	
Web UI Account	Username	root	After login, change the default username/password to use other functions.
	Password	root	

- **Maintenance**

This function is only provided to ICP DAS R&D personnel for maintenance using. It is reserved and not open for use.

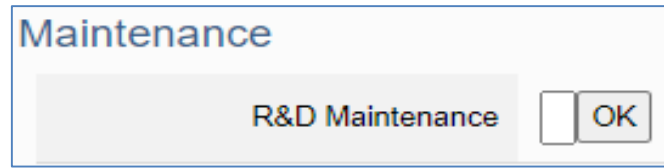

4.2 Main Menu - Module Setting

This main menu aggregates all module and project in the module related function settings. This chapter focuses on parameter descriptions. About the detailed steps and notices for using OPC UA connection/certificate, please refer to [3.1 Settings for Using OPC UA Connection](#) of [Chapter 3 Main Function Settings](#).

4.2.1 I/O Setting

Function: Display and change the I/O settings of the UA I/O module.

Support Module: All UA I/O modules support this function.

Manu Path: 【 Module Setting 】 → 【 I/O Setting 】 Module Setting → I/O Setting ([Appendix A](#)).

- **Digital Input**

Digital Input		
Channel	MQTT Alias	OPC UA Description
IN0	<input type="text" value="IN0"/>	<input type="text"/>
IN1	<input type="text" value="IN1"/>	<input type="text"/>
IN2	<input type="text" value="IN2"/>	<input type="text"/>
IN3	<input type="text" value="IN3"/>	<input type="text"/>
IN4	<input type="text" value="IN4"/>	<input type="text"/>
IN5	<input type="text" value="IN5"/>	<input type="text"/>
IN6	<input type="text" value="IN6"/>	<input type="text"/>
IN7	<input type="text" value="IN7"/>	<input type="text"/>
<input type="button" value="Save"/>		

Module Setting > I/O Setting - Digital Input	
Channel	The channel name (number) of the UA I/O hardware.
MQTT Alias	The variable alias of the sending message (MQTT JSON format), when using MQTT connection.
OPC UA Description	The messages got from the description column of OPC Client, when using OPC UA connection.

● Digital Output

Digital Output			
Channel	MQTT Alias	OPC UA Description	Power-on Value
DO0	<input type="text" value="DO0"/>	<input type="text"/>	<input type="checkbox"/>
DO1	<input type="text" value="DO1"/>	<input type="text"/>	<input type="checkbox"/>
DO2	<input type="text" value="DO2"/>	<input type="text"/>	<input type="checkbox"/>
DO3	<input type="text" value="DO3"/>	<input type="text"/>	<input type="checkbox"/>
DO4	<input type="text" value="DO4"/>	<input type="text"/>	<input type="checkbox"/>
DO5	<input type="text" value="DO5"/>	<input type="text"/>	<input type="checkbox"/>
DO6	<input type="text" value="DO6"/>	<input type="text"/>	<input type="checkbox"/>
DO7	<input type="text" value="DO7"/>	<input type="text"/>	<input type="checkbox"/>

Module Setting > I/O Setting - Digital Output	
Channel	The channel name (number) of the UA I/O hardware.
MQTT Alias	The variable alias of the sending message (MQTT JSON format), when using MQTT connection.
OPC UA Description	The messages got from the description column of OPC Client, when using OPC UA connection.
Power-on Value	The initial value of the I/O channel after the power off and restart to on.

● Analog Input

Analog Input			
Channel	MQTT Alias	OPC UA Description	Input Type
Vin0	<input type="text" value="Vin0"/>	<input type="text"/>	4 ~ 20 mA ▾
Vin1	<input type="text" value="Vin1"/>	<input type="text"/>	0 ~ 20 mA ▾
Vin2	<input type="text" value="Vin2"/>	<input type="text"/>	-20 ~ 20 mA ▾
Vin3	<input type="text" value="Vin3"/>	<input type="text"/>	-20 ~ 20 mA ▾
Vin4	<input type="text" value="Vin4"/>	<input type="text"/>	-20 ~ 20 mA ▾
Vin5	<input type="text" value="Vin5"/>	<input type="text"/>	-20 ~ 20 mA ▾

Module Setting > I/O Setting – Analog Input	
Channel	The channel name (number) of the UA I/O hardware.
MQTT Alias	The variable alias of the sending message (MQTT JSON format), when using MQTT connection.
OPC UA Description	The messages got from the description column of OPC Client, when using OPC UA connection.
Input Type	Select the Input type by user's need.

● **Analog Output**

Analog Output				
Channel	MQTT Alias	OPC UA Description	Power-on Value	Output Type
Vout0	<input type="text" value="Vout0"/>	<input type="text"/>	<input type="text" value="4"/>	<input type="text" value="4 ~ 20 mA"/> ▼
Vout1	<input type="text" value="Vout1"/>	<input type="text"/>	<input type="text" value="3.202"/>	<input type="text" value="0 ~ 20 mA"/> ▼

Module Setting > I/O Setting – Analog Output	
Channel	The channel name (number) of the UA I/O hardware.
MQTT Alias	The variable alias of the sending message (MQTT JSON format), when using MQTT connection.
OPC UA Description	The messages got from the description column of OPC Client, when using OPC UA connection.
Power-on Value	The initial value of the I/O channel after the power off and restart to on. (U-7504M will support later, other models support now.)
Output Type	Select the Output type by user’s need.

4.2.2 I/O Status

Function: Display and change the I/O status of the UA I/O module.

Support Module: All UA I/O modules support this function.

Manu Path: 【 Module Setting 】 → 【 I/O Status 】 Module Setting → I/O Status (Appendix A).

● Digital Input

Digital Input		
Channel	Value	Status
IN0	<input type="checkbox"/>	GOOD
IN1	<input type="checkbox"/>	GOOD
IN2	<input type="checkbox"/>	GOOD
IN3	<input type="checkbox"/>	GOOD
IN4	<input type="checkbox"/>	GOOD

Module Setting > I/O Status - Digital Input	
Channel	The channel name (number) of the UA I/O hardware.
Value	Current channel status value. When the value changes, the signal LED will change.
Status	GOOD, BAD, or UNCERTAIN.

● Digital Output

Digital Output		
Channel	Value	Status
DO0	<input type="checkbox"/>	GOOD
DO1	<input type="checkbox"/>	GOOD
DO2	<input type="checkbox"/>	GOOD

Module Setting > I/O Status - Digital Output	
Channel	The channel name (number) of the UA I/O hardware.
Value	Current channel status value. When the value changes, the signal LED will change.
Status	GOOD, BAD, or UNCERTAIN.

● Analog Input

Analog Input		
Channel	Value	Status
Vin0	<input type="text" value="-32.768"/>	GOOD
Vin1	<input type="text" value="0"/>	GOOD
Vin2	<input type="text" value="0"/>	GOOD
Vin3	<input type="text" value="0"/>	GOOD
Vin4	<input type="text" value="-0.001"/>	GOOD

Module Setting > I/O Status – Analog Input	
Channel	The channel name (number) of the UA I/O hardware.
Value	Current channel status value. When the input type is 4-20mA, if an abnormal state occurs, the value will display as -32.768.
Status	GOOD, BAD, or UNCERTAIN.

● Analog Output

Analog Output		
Channel	Value	Status
Vout0	<input type="text" value="4"/>	GOOD
Vout1	<input type="text" value="3.202"/>	GOOD

Module Setting > I/O Status - Analog Output	
Channel	The channel name (number) of the UA I/O hardware.
Value	Current channel status value.
Status	GOOD, BAD, or UNCERTAIN.

4.2.3 Project File

Function: download and upload the project file of the UA I/O module.

Support Module: All UA I/O modules support this function.

Manu Path: 【 Module Setting 】 → 【 Project File 】 Module Setting → Project File (Appendix A).

- **Download the file from device**

Download the project file, for back up the project settings.

Click [Download] button, the project file in the UA I/O can be download to the operating PC.

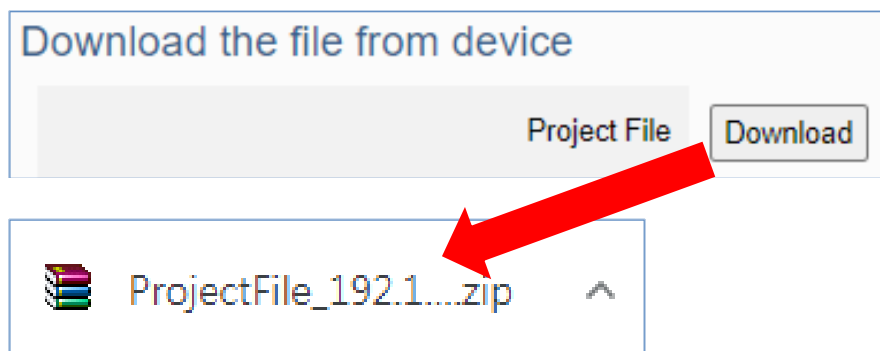

- **Upload the file to the device**

Upload the project file into the UA I/O. This function can quickly replace the previously backed up project file, and then restore the project setting parameters.

Click [Upload] button, select the project file in the PC.

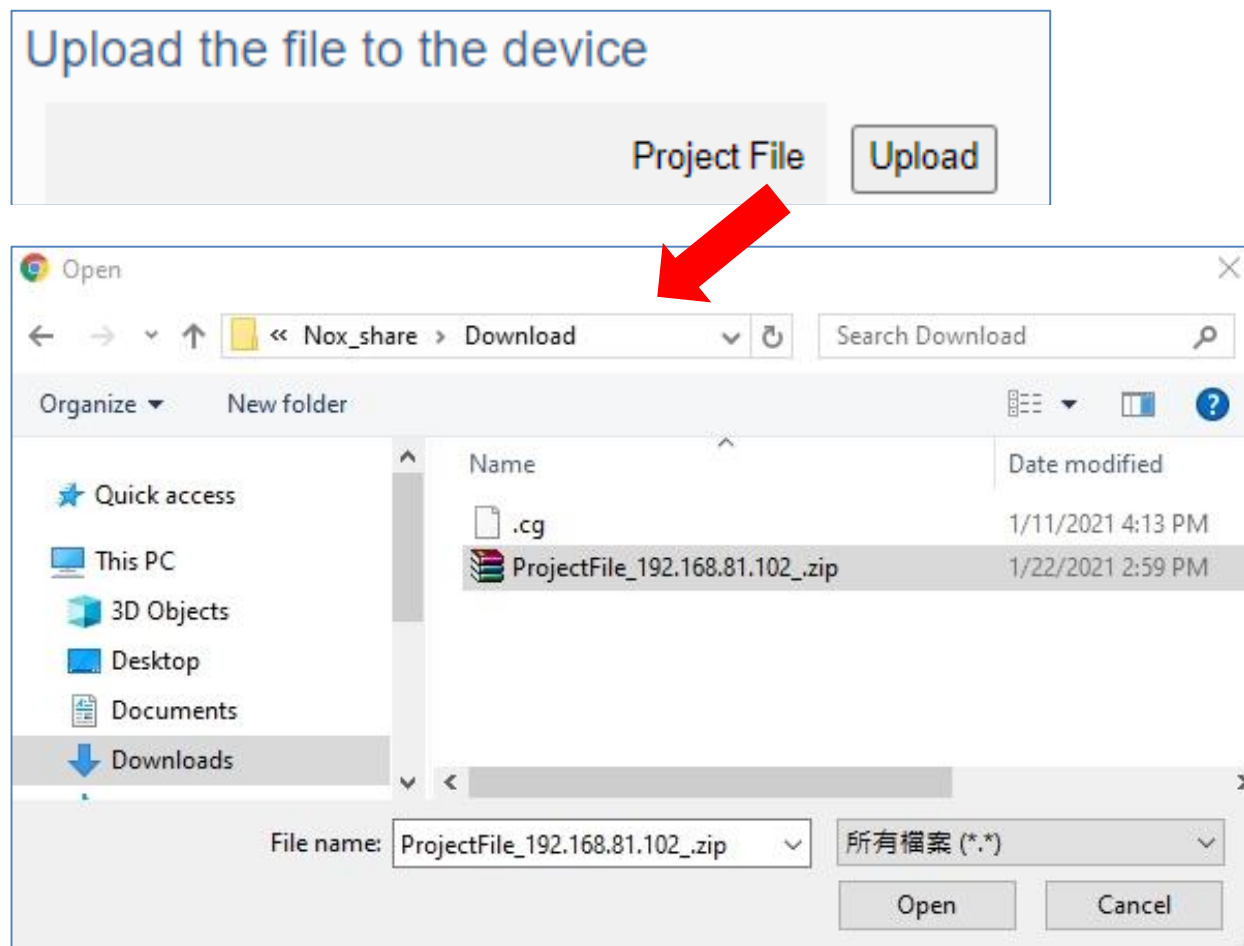

4.3 Main Menu - OPC UA Setting

This main menu aggregates all OPC UA related settings. This chapter focuses on parameter descriptions. About the detailed steps and notices for using OPC UA connection/certificate, please refer to [3.1 Settings for Using OPC UA Connection](#) of [Chapter 3 Main Function Settings](#).

NOTE:

When the main menu “**OPC UA Setting**” has a message of “**Please remove the server certificate**” (as the picture below), that means there is something error about the server certificate file.

Please click the menu **【OPC UA Setting】** → **【Certificate】**  (Appendix A) to remove the Server Certificate, the function of OPC UA menu will be normal again.

The operation to remove the Server Certificate, please refer to the next two section “[4.3.2 Certificate](#)”.

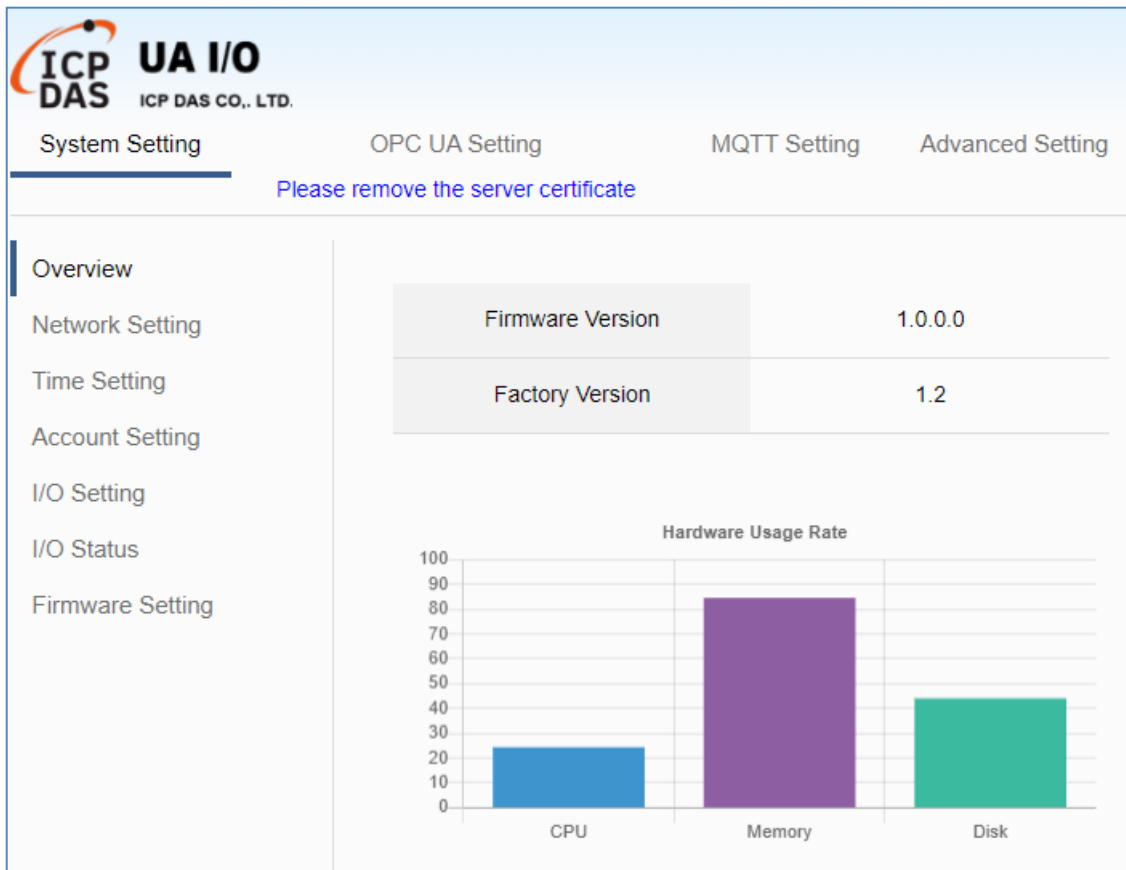

4.3.1 Server Setting

Function: Provide the Server settings for using OPC UA connection.

Support Module: All UA I/O modules support this function.

Manu Path: 【OPC UA Setting】 → 【Server Setting】 OPC UA Setting → Server Setting (Appendix A).

Connection Setting

Port	48010
Anonymous Login	<input checked="" type="checkbox"/> Enable
Username Password Login	<input checked="" type="checkbox"/> Enable
Certificate Login	<input type="checkbox"/> Enable

Save

OPC UA Setting > Server Setting - Connection Setting	
Port	The communication port number of the OPC UA Server. System Default: 48010.
Anonymous Login	Check to enable the anonymous login from clients.
Username Password Login	Check to enable the user password login from clients. (The username and password here is the same as the login username and password of the Web UI.)
Certificate Login	Check to enable the certificate login from clients. (refer to next section 4.2.2)
Save	Click to save the connection settings of OPC UA Server.

4.3.2 Certificate

Function: When selecting OPC UA certificate connection, the UA I/O (Server side) needs to exchange the certificate with the connecting client side. This page is about setting the OPC UA Certificate for the security and encryption, e.g. upload, download, delete certificate.

Support Module: All UA I/O modules support this function.

Manu Path: 【 OPC UA Setting 】 → 【 Certificate 】 OPC UA Setting → Certificate ([Appendix A](#)).

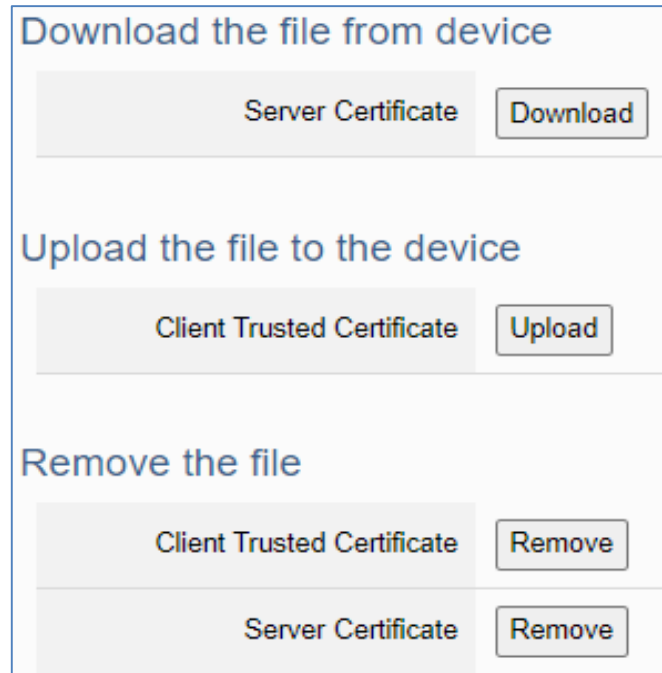

OPC UA Setting > Certificate – Download the file from device	
Server Certificate	Click “Download” to download the OPC UA Server Certificate file to PC for the using of the client side device. File Name: icpdasuaserver.der
OPC UA Setting > Certificate –Upload the file to the device	
Client Trusted Certificate	Click “Upload” to select the OPC UA Client Trusted Certificate file in PC, and upload the Trusted Certificate file to the UA I/O module.
OPC UA Setting > Certificate – Remote the file	
Client Trusted Certificate	Client “Remove” to delete all Client Trusted Certificate files.
Server Certificate	Client “Remove” to delete all Server Certificate files.

4.4 Main Menu – MQTT Setting

This main menu aggregates all MQTT related settings. This chapter focuses on parameter descriptions. About the detailed steps and notices for using MQTT connection/certificate, please refer to [3.2 Settings for Using MQTT Connection](#) of [Chapter 3 Main Function Settings](#).

4.4.1 Connection Setting

Function: Provide the remote MQTT Broker settings for using MQTT connection.

Support Module: All UA I/O modules support this function.

Manu Path: [【 MQTT Setting 】](#) → [【 Connection Setting 】](#)  →  ([Appendix A](#)).

Connection Setting

IP Address	<input style="width: 90%;" type="text" value="127.0.0.1"/>
Port	<input style="width: 90%;" type="text" value="1883"/>
Anonymous Login	<input type="checkbox"/> Enable
Username	<input style="width: 90%;" type="text" value="root"/>
Password	<input style="width: 90%;" type="password" value="...."/>

MQTT Setting > Connection Setting	
IP Address	The IP address of the remote MQTT Broker
Port	The communication port number of the remote MQTT Broker.
Anonymous Login	When checking the item box, it can connect without a username and password. If not checked, it needs to set a username and password.
Username	The username to login the remote MQTT Broker
Password	The password to login the remote MQTT Broker
Save	Click to save the setting of this page.

4.4.2 Client Setting

Function: Provide the MQTT Client settings for using MQTT connection.

Support Module: All UA I/O modules support this function.

Manu Path: 【MQTT Setting】 → 【Client Setting】 MQTT Setting → Client Setting ([Appendix A](#)).

Content Setting

Scan Rate(ms)	<input style="width: 90%;" type="text" value="1000"/>
Dead Band	<input style="width: 90%;" type="text" value="0"/>
Will Topic	<input style="width: 90%;" type="text"/>
Will	<input style="width: 90%;" type="text"/>
JSON Format	<input checked="" type="checkbox"/> Enable

MQTT Setting > Client Setting – Content Setting	
Scan Rate(ms)	Set an update frequency for the task data. Default: 1000 (Unit: ms)
Dead Band	Give a dead bend value for updating a float signal. Default: 0
Will Topic	Enter the title of a disconnect notice. Default: Null.
Will	Enter a disconnect notice. Default: Null.
JSON Format	Switch the format for sending MQTT messages. If "Enable" is checked, the message will send in groups. For the message format, please refer to Appendix B . If "Enable" is not checked, the message will send in singly.

If the JSON format is checked as "Enable", the message is sent as a group. For its setting items and parameter descriptions, please see the next page.

If the JSON format is not checked, the message is sent in singly. For its setting items and parameter descriptions, please see the page after the next page.

- **JSON Format: Enable** (message is sent as a group):

Publish & Subscribe

Publish Topic	<input type="text" value="/Name/Publish"/>
Publish QoS	<input style="border-bottom: none; border-right: none; border-top: none; border-left: none; width: 100%;" type="text" value="2"/> ▼
Subscribe Topic	<input type="text" value="/Name/Subscribe"/>
Subscribe QoS	<input style="border-bottom: none; border-right: none; border-top: none; border-left: none; width: 100%;" type="text" value="2"/> ▼
Retain	<input style="border-bottom: none; border-right: none; border-top: none; border-left: none; width: 100%;" type="text" value="False"/> ▼

MQTT Setting > Client Setting - Publish & Subscribe (JSON Format: <input checked="" type="checkbox"/> Enable)	
Publish Topic	The topic of sending data / publishing message.
Publish QoS	The publish Qos (Quality of Service) levels. Default: 2 0: Delivering a message at most once. 1: Delivering a message at least once. 2: Delivering a message at exactly once.
Subscribe Topic	The topic of receiving data / subscribing message. It can copy the Publish Topic of linked device.
Subscribe QoS	The subscribe Qos (Quality of Service) levels. Default: 2 0: Delivering a message at most once. 1: Delivering a message at least once. 2: Delivering a message at exactly once.
Retain	Set up if the Broker retains the message.
Save	Click to save the setting of this page.

● **JSON Format: Not Enable** (message is sent in singly):

JSON Format Enable

Publish & Subscribe

Details Unfold

Channel	Publish Topic	Subscribe Topic
<input type="text" value="DO0"/>	<input type="text" value="/U-7526M/DO0/Publish"/>	<input type="text" value="/U-7526M/DO0/Subscribe"/>
<input type="text" value="DO1"/>	<input type="text" value="/U-7526M/DO1/Publish"/>	<input type="text" value="/U-7526M/DO1/Subscribe"/>
<input type="text" value="DI0"/>	<input type="text" value="/U-7526M/DI0/Publish"/>	<input type="text"/>
<input type="text" value="DI1"/>	<input type="text" value="/U-7526M/DI1/Publish"/>	<input type="text"/>
<input type="text" value="Vout0"/>	<input type="text" value="/U-7526M/Vout0/Publish"/>	<input type="text" value="/U-7526M/Vout0/Subscribe"/>
<input type="text" value="Vout1"/>	<input type="text" value="/U-7526M/Vout1/Publish"/>	<input type="text" value="/U-7526M/Vout1/Subscribe"/>
<input type="text" value="Vin0"/>	<input type="text" value="/U-7526M/Vin0/Publish"/>	<input type="text"/>
<input type="text" value="Vin1"/>	<input type="text" value="/U-7526M/Vin1/Publish"/>	<input type="text"/>
<input type="text" value="Vin2"/>	<input type="text" value="/U-7526M/Vin2/Publish"/>	<input type="text"/>
<input type="text" value="Vin3"/>	<input type="text" value="/U-7526M/Vin3/Publish"/>	<input type="text"/>
<input type="text" value="Vin4"/>	<input type="text" value="/U-7526M/Vin4/Publish"/>	<input type="text"/>
<input type="text" value="Vin5"/>	<input type="text" value="/U-7526M/Vin5/Publish"/>	<input type="text"/>

MQTT Setting > Client Setting - Publish & Subscribe (JSON Format: <input type="checkbox"/> Enable)	
Details	Check “Unfold” to display all fields.
Channel	The I/O channel name of the hardware.
Publish Topic	The topic of sending data / publishing message.
Publish QoS	The publish QoS (Quality of Service) levels. Default: 2 0: Delivering a message at most once. 1: Delivering a message at least once. 2: Delivering a message at exactly once.
Subscribe Topic	The topic of receiving data / subscribing message. It can copy the Publish Topic of linked device.
Subscribe QoS	The subscribe QoS (Quality of Service) levels. Default: 2 0: Delivering a message at most once. 1: Delivering a message at least once. 2: Delivering a message at exactly once.
Retain	Set up if the Broker retains the message. Check “Retain” box of the top row can store the broker message for all variables in list.
Save	Click to save the setting of this page.

4.4.3 Certificate

Function: When selecting MQTT certificate connection, the UA I/O needs to exchange the certificate with the connecting device. This page is about setting the MQTT Certificate for the security and encryption.

Support Module: All UA I/O modules support this function.

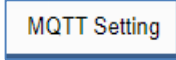
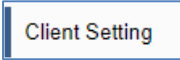
Manu Path: 【MQTT Setting】 → 【Client Setting】  →  (Appendix A).

1. “SSL/TLS” is not "enable" by default. When not enabled, other setting items will be hidden.

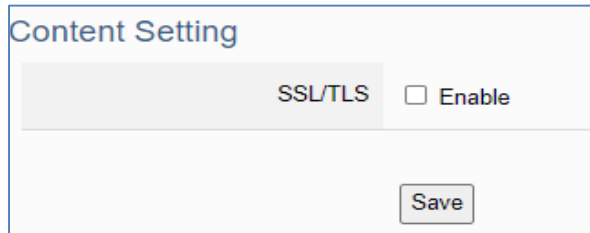

MQTT Setting > Certificate – Content Setting	
SSL/TLS	Check the box and click “Save” to enable the settings for SSL/TLS secure communication. Default: uncheck. The setting items will not appear until clicking the "Save" button.

2. Authentication setting item will show up after enable “SSL/TLS”. Select one way or two way authentication.

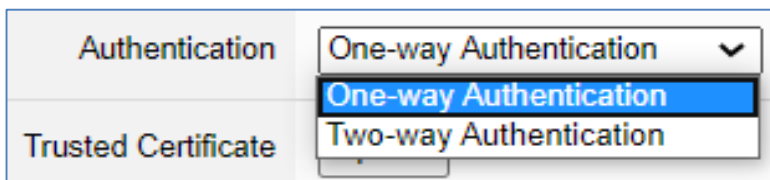

One-way authentication: The **Client verifies** the validity of **Broker** credentials.

Two-way authentication: The **Client and Broker verify** the validity of the certificate with **each other**.

This setting page is setting for the MQTT secure encrypted communication (SSL/TLS: Secure Socket Layer / Transport Layer Security). Before setting this function, you need to download or upload the relevant certificates. There are three types of certificates: Trusted Certificate, Certificate, and Private Key. Please upload the files to the UA I/O module according to the type of certificates.

To perform the One-way authentication, you need to upload the Trusted Certificate.

To perform the Two-way authentication, you need to upload the Trusted Certificate first, and then upload the Certificate and Private Key.

Parameter Function Descriptions:

One-way Authentication Screen

Upload the file to the device

Authentication	One-way Authentication ▼
Trusted Certificate	Upload

Remove the file

Trusted Certificate	Remove
---------------------	--------

Two-way Authentication Screen

Upload the file to the device

Authentication	Two-way Authentication ▼
Trusted Certificate	Upload
Certificate	Upload
Private Key	Upload

Remove the file

Trusted Certificate	Remove
Certificate	Remove
Private Key	Remove

MQTT Setting > Certificate – Upload the file to the device	
Authentication	<p>One-way authentication: The Client verifies the validity of Broker credentials; need to upload the Trusted Certificate.</p> <p>Two-way authentication: The Client and Broker verify the validity of the certificate with each other; need to upload the Trusted Certificate first, and then upload the Certificate and Private Key.</p>
Trusted Certificate	<p>Upload: Click to select the MQTT Trusted Certificate file of the device, and upload the MQTT Trusted Certificate file to the UA I/O module.</p> <ul style="list-style-type: none"> File format must be PEM. Extension name must be “pem”, “cer”, or “crt”.
Certificate	<p>Upload: Click to select the MQTT Certificate file of the device, and upload the MQTT Certificate file to the UA I/O module.</p> <ul style="list-style-type: none"> File format must be PEM. Extension name must be “pem”, “cer”, or “crt”.
Private Key	<p>Upload: Click to select the MQTT Private Key of the device, and upload the MQTT Private Key file to the UA I/O module.</p> <ul style="list-style-type: none"> File format must be PEM. Extension name must be “key”.
MQTT Setting > Certificate – Remove the file	
Trusted Certificate	Click “Remove” to delete all Trusted Certificate files in the UA I/O module.
Certificate	Click “Remove” to delete all Certificate files in the UA I/O module.
Private Key	Click “Remove” to delete all Private Key files in the UA I/O module.

4.5 Main Menu – Advanced Setting

This main menu aggregates the advanced settings, such as the Scaling setting that function can convert the analog signal to a more readable value. The scaling function is only available for AI/AO channels. ICP DAS will develop more advanced functions in the future.

4.5.1 Scaling

Function: The Scaling function convert the analog signal to a more readable value. This function is only available for modules with AI/O.

Support Module: All UA AI/AO modules support this function.

Manu Path: 【Advanced Setting】 → 【Scaling】 Advanced Setting → Scaling (Appendix A).

When the variable value needs to be scaled or converted before output. Fill in the Min/Max items of the Source/Output Variable; and add a description, the Scaling conversion function will be activated.

Source variable		Output variable		Description
Vout0		Scale_Vout0		
Min	0	Min	20	
Max	10	Max	50	
		Offset	0	
Vout1		Scale_Vout1		
Min	0	Min	20	
Max	10	Max	50	
		Offset	0	

Advanced Setting > Scaling – Content Setting	
Min (Source variable)	The source variable that to be converted; Fill in its minimum value.
Max (Source variable)	The source variable that to be converted; Fill in its maximum value.
Min (Output variable)	The output variable that to be converted; Fill in its minimum value.
Max (Output variable)	The output variable that to be converted; Fill in its maximum value.
Description	Write a note for this variable by user needs.

4.5.2 Event Log

Function: When the I/O value changes, record the current I/O value for easy device tracking in the future.

Support Module: All UA AI/AO modules support this function.

Manu Path: 【Advanced Setting】 → 【Event Log】 Advanced Setting → Event Log (Appendix A).

Setting
Log File Download

Single File Size (MB)

10

Sampling Interval Time (milliseconds)

1000

Advanced Setting > Event Log – Setting	
Single File Size (MB)	The maximum size can be recorded in each single log file.
Sampling Interval Time (milliseconds)	Enter the interval time (milliseconds) to obtain the current value of UA I/O.

Digital Input / Output

Alias	ON (log message)	OFF (log message)	Enable
<input style="width: 90%;" type="text" value="RL0"/>	<input style="width: 90%;" type="text" value="ON"/>	<input style="width: 90%;" type="text" value="OFF"/>	<input checked="" type="checkbox"/>
<input style="width: 90%;" type="text" value="RL1"/>	<input style="width: 90%;" type="text" value="ON"/>	<input style="width: 90%;" type="text" value="OFF"/>	<input type="checkbox"/>
<input style="width: 90%;" type="text" value="RL2"/>	<input style="width: 90%;" type="text" value="ON"/>	<input style="width: 90%;" type="text" value="OFF"/>	<input type="checkbox"/>
<input style="width: 90%;" type="text" value="RL3"/>	<input style="width: 90%;" type="text" value="ON"/>	<input style="width: 90%;" type="text" value="OFF"/>	<input type="checkbox"/>

Advanced Setting > Event Log –Digital Input / Output	
Alias	The alias name in function of [Module Setting] > [I/O Setting]
ON (log message)	When I/O is ON, the log file will store this log message. Easy for customers to read.
OFF (log message)	When I/O is OFF, the log file will store this log message. Easy for customers to read.
Enable	Check this item to enable the event log function for this I/O. Default: not enabled

Analog Input / Output				
Alias	Deadband	Above The Upper Limit (log message)	Below The Lower Limit (log message)	Enable
Vout0	1	Over Deadband	Below Deadband	<input type="checkbox"/>
Vout1	1	Over Deadband	Below Deadband	<input type="checkbox"/>
Vin0	1	Over Deadband	Below Deadband	<input type="checkbox"/>
Vin1	1	Over Deadband	Below Deadband	<input type="checkbox"/>
Vin2	1	Over Deadband	Below Deadband	<input type="checkbox"/>
Vin3	1	Over Deadband	Below Deadband	<input type="checkbox"/>
Vin4	1	Over Deadband	Below Deadband	<input type="checkbox"/>
Vin5	1	Over Deadband	Below Deadband	<input type="checkbox"/>

Advanced Setting > Event Log –Analog Input / Output	
Alias	The alias name in function of [Module Setting] > [I/O Setting]
Deadband	Set the Deadband value for updating floating-point data. Default: 1 Deadband: Dead zone, inactive zone.
Above The Upper Limit (log message)	When the upper limit of Deadband is exceeded, the log file will store this log message. Easy for customers to read.
Below The Lower Limit (log message)	When it is lower than the lower limit of Deadband, the log file will store this log message. Easy for customers to read.
Enable	Check this item to enable the event log function for this I/O. Default: not enabled

Setting	
Log File Download	
File Name	Download
log_2021-9-3_17-3-12.csv	<input type="button" value="Download"/>

Advanced Setting > Event Log – Log File Download	
File Name	The file name is composed of year, month, day, hour, minute, and second. This time is the time of the first content.
Download	Click this button to download the log file.

4.5.3 Rule Setting

Function: The Rule Setting function provides simple logic condition rule setting, let UA I/O do automatic condition judgment and action control, to achieve simple AI.

Support Module: All UA AI/AO modules support this function.

Manu Path: 【Advanced Setting】 → 【Rule Setting】 Advanced Setting → Rule Setting ([Appendix A](#)).

Content Setting

Sampling Interval Time
(milliseconds)

100

Advanced Setting >Rule Setting – Content Setting	
Sampling Interval Time (milliseconds)	Enter the interval time (milliseconds) to obtain the current value of UA I/O.

Tip: For the logic condition setting steps of rule setting, please refer to [Section 3.3](#).

5. Recovering Firmware Setting (Reset)

This chapter explains how to use the Reset button to recover the firmware settings.

The steps are as follows:

1. Please find the **Reset** button on the UA I/O bottom side, and then press the **Reset** button.

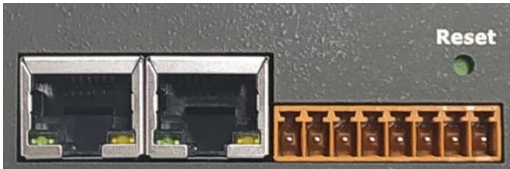

2. When starting the recovering process, all the LEDs on the panel will light up red or green.



3. If all LEDs light on red, it indicates an error. When this happens, please press the Reset button again.



4. If all LEDs light on green, it means the recovering process is successful.



5. After restarting, the module will recover the UA I/O settings as follows:

Recovering Firmware of UA I/O Modules			
Network	IP (LAN)	Keep the original setting	Assign UA I/O a new IP setting according to your case.
	Netmask	Keep the original setting	
	Gateway	Keep the original setting	
Web UI Account	Username	root	After login, change the default username/password to use other functions.
	Password	root	

Appendix A. Menu Path Diagram Description

【Menu Path】 diagram shows the main menu function section path in a brief way that user can follow the menu path order (text/diagram) to select the main menu and the sub-menu, then can go to the function setting web page. Please see the examples below for detail description.

[Example 1] Description for the menu path of 【System Setting】 → 【Overview】 :

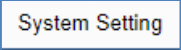
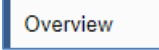
1. Click 【System Setting】 function of main menu on the upper side, such as  .
2. Click 【Overview】 function of sub-menu appeared on the left side, such as  .
3. Check or set up the information or function items on the setting area of the 【Overview】 .

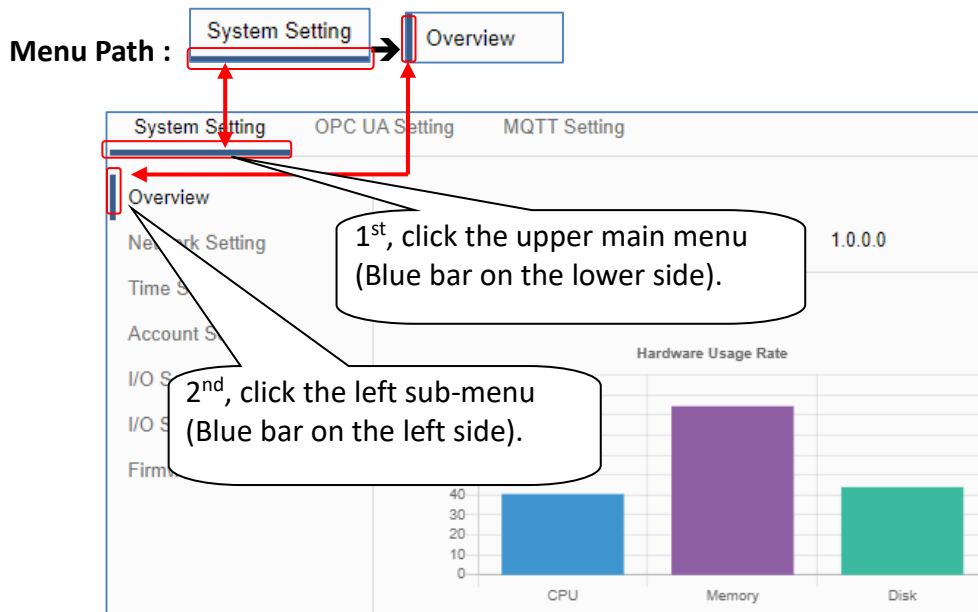

[Example 2] Description for the menu path of 【OPC UA Setting】 → 【Certificate】 :

1. Click 【OPC UA Setting】 function of main menu on the upper side, as below.
2. Click 【Certificate】 function of sub-menu appeared on the left side, as below.
3. Set up the function items on the setting area of the 【Certificate】 .

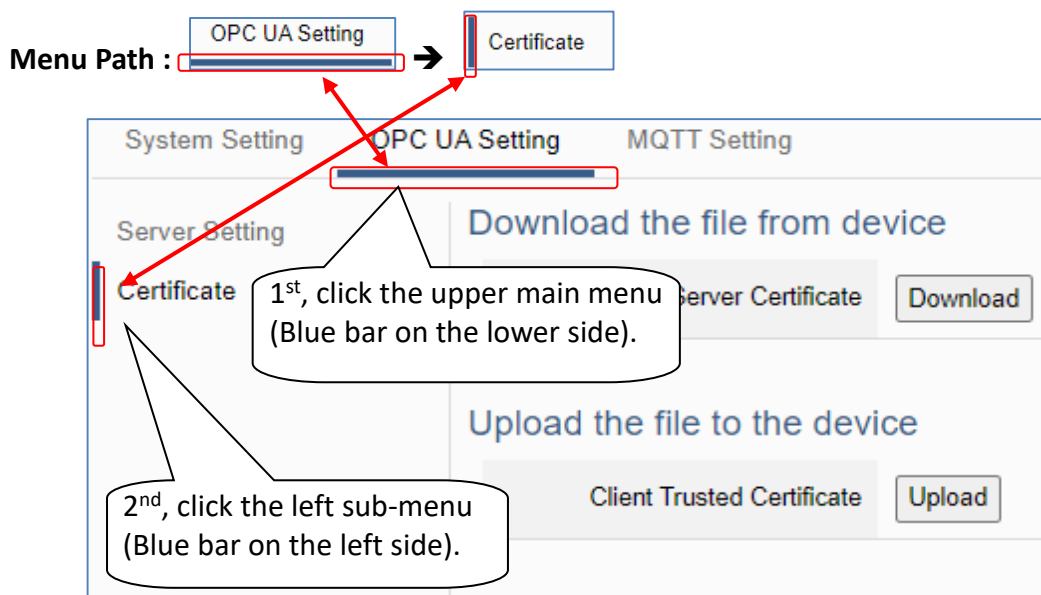

Appendix B. MQTT JSON Format of the UA I/O Series

MQTT JSON Example & Format Descriptions:

```
{
  "Variable" : [ {
    "Name" : "Bool_R[0]",
    "Attribute" : "R",
    "Datatype" : "Bool",
    "Value" : 0,
    "Quality" : "Uncertain"
  }, {
    "Name" : "Short_R[0]",
    "Attribute" : "R",
    "Datatype" : "Int16",
    "Value" : 0,
    "Quality" : "Uncertain"
  }, {
    "Name" : "Short_R[1]",
    "Attribute" : "R",
    "Datatype" : "Int16",
    "Value" : 0,
    "Quality" : "Uncertain"
  }, {
    "Name" : "Short_R[2]",
    "Attribute" : "R",
    "Datatype" : "Int16",
    "Value" : 0,
    "Quality" : "Uncertain"
  }, {
    "Name" : "Short_RW[2]",
    "Attribute" : "RW",
    "Datatype" : "Int16",
    "Value" : 0,
    "Quality" : "Uncertain"
  }
  ]
}
```

Name	Descriptions
Variable	The array name of JSON. Its structure includes several member data as below.
Name	The member name of the array element
Attribute	The member attribute of the array element: "R" : can read "W" : can write "RW" : can read and write
Datatype	The member's data type of the array element: "Bool" "Int8" "UInt8" "UInt16" "Int16" "UInt32" "Int32" "UInt64" "Int64" "Float" "Double" "String"
Value	The member's current value of the array element
Quality	The member's current status of the array element: "Uncertain" "Good" "Bad"